

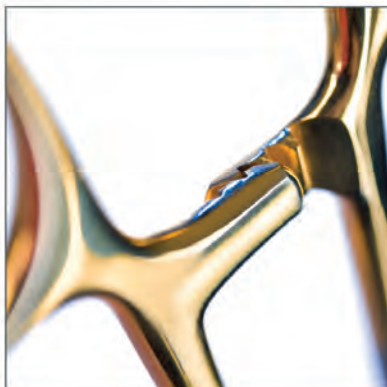

Generalni katalog instrumenata

Chirurgische Instrumente
Surgical Instruments
Instrumentos quirúrgicos
Strumenti chirurgici



Reda Instrumente GmbH

Gänsäcker 34 · P.O. Box 131
D-78532 Tuttlingen

Telefon +49 / 74 62 / 94 45-0

Telefax +49 / 74 62 / 94 45-20

E-mail: info@Reda-Instrumente.de

<http://www.Reda-Instrumente.de>

Ausgabe Nr. 7

Datum: 01/2009



Charrière (Ch) French (F)	Durchmesser in mm	Inches
1	0,33	0,013
2	0,67	0,025
3	1,00	0,039
4	1,33	0,051
5	1,67	0,065
6	2,00	0,0787
7	2,33	0,092
8	2,67	0,105
9	3,00	0,1181
10	3,33	0,131
11	3,67	0,144
12	4,00	0,1575
13	4,33	0,170
14	4,67	0,184
15	5,00	0,1968
16	5,33	0,210
17	5,67	0,223
18	6,00	0,2362
19	6,33	0,249
20	6,67	0,263
21	7,00	0,2756
22	7,33	0,288
23	7,67	0,302
24	8,00	0,3150
25	8,33	0,328
26	8,67	0,341
27	9,00	0,3543
28	9,33	0,367
29	9,67	0,380
30	10,00	0,3973
31	10,33	0,407
32	10,67	0,420
34	11,33	0,446
36	12,00	0,4724
38	12,67	0,494
40	13,33	0,5199
45	15,00	0,5905

Gauge (G)	Durchmesser in mm	Inches
35	0,13	0,005
34	0,18	0,007
33	0,20	0,008
32	0,23	0,009
31	0,25	0,010
30	0,30	0,012
29	0,33	0,013
28	0,36	0,014
27	0,41	0,016
26	0,46	0,018
25	0,51	0,020
	0,53	0,021
24	0,56	0,022
23	0,64	0,025
22	0,71	0,028
21	0,81	0,032
20	0,89	0,035
	0,97	0,038
19	1,07	0,042
18	1,27	0,050
17	1,50	0,059
16	1,65	0,065
15	1,83	0,072
14	2,11	0,083
13	2,41	0,095
12	2,77	0,109
11	3,05	0,120
10	3,40	0,134
9	3,76	0,148
8	4,19	0,165
7	4,57	0,180
6	5,16	0,203

1 OZ	0,028 ml
5 OZ	0,140 ml
16 OZ	0,450 ml

35 OZ	1,0 l
128 OZ	3,7 l

Index

03: Diagnostik
05: Narkose
07: Skalpelle, Messer
09: Scheren
10: Mikroscheren
11: Pinzetten
12: Mikrochirurgie-Pinzetten

13: Klemmen
15: Tuchklemmen
17: Tupferzangen
19: Wundhaken
21: Sonden, Watteträger
23: Trokare, Biopsiekanülen, Führungsnadeln
25: Nadelhalter
27: Naht
29: Sterilisations-Instrumente

31: Verband, Gips
33, 34: Knochenchirurgie
41: Neurochirurgie
43, 44: Ophthalmologie
45: Otologie
47: Rhinologie
49: Mund und Zunge
51: Tonsilleltomie
53: Laryngo-, Bronchoskopie
55: Tracheotomie
57: Thorax
61: Herz- und Gefäßchirurgie
63: Galle
65: Magen, Darm
67: Urologie
69: Rektum
71: Gynäkologie
73: Geburtshilfe
75: Dermatologie
89: Sterilisation, Behälter
91: Hochfrequenz-Chirurgie

Index

Diagnostic
Anesthesia
Scalpels
Scissors
Micro Scissors
Thumb and Tissue Forceps
Microsurgery Forceps
Atrauma Bulldog Clamps
Hemostatic Forceps
Towel Forceps
Dressing Forceps
Retractors
Probes, Cotton Applicators
Trocars

Needle Holders
Suturing Instruments
Sterilization Instruments

Plaster of Paris
Bone Surgery
Neurosurgery
Ophtalmology
Otology
Rhinology
Mouth and Tongue
Tonsils
Larynx
Tracheotomy
Thorax
Cardiovascular Surgery
Gall and Kidney
Intestines, Stomach
Urology
Rectum
Gynecology
Obstetrics
Dermatology, Hygiene
Different Containers
High Fequency Surgery

Indice

03:	Diagnóstico
05:	Anestesia
07:	Bisturíes
09:	Tijeras
10:	Tijeras p/micro cirugía
11:	Pinzas de disección
12:	Pinzas p/micro cirugía Clamp Atrauma Bulldog
13:	Pinzas hemostáticas
15:	Pinzas de campo
17:	Pinzas p/tapones
19:	Separadores
21:	Sondas, Porta-algodón
23:	Trócares
25:	Porta-agujas
27:	Instrumentos para sutura
29:	Instrumentos para la esterilización
31:	Vendajes enyesados
33, 34:	Cirugía ósea
41:	Neurocirugía
43, 44:	Oftalmología
45:	Otología
47:	Rinología
49:	Boca y lengua
51:	Amígdalas
53:	Laringe
55:	Traqueotomía
57:	Tórax
61:	Cirugía cardiovascular
63:	Vesícula biliar
65:	Intestinos, Estómago
67:	Urología
69:	Recto
71:	Ginecología
73:	Obstetricia
75:	Dermatología, Higiene
89:	Contenedores varios
91:	Electrocirugía

Index

Diagnostica
Anestesia
Bisturi
Forbici
Forbici per microchirurgia
Pinze per dissezione
Pinze per microchirurgia
Pinze Atrauma Bulldog
Pinze emostatiche
Pinze fissateli
Pinze per medicatura
Divaricatori
Sonde, Portacotone
Trequarti
Port'aghi
Strumenti per suture
Strumenti per la sterilizzazione
Bendaggi gessati
Chirurgia ossea
Neurochirurgia
Oftalmologia
Otologia
Rinologia
Bocca e lingua
Tonsille
Laringe
Tracheotomia
Torace
Chirurgia cardiovascolare
Vescicola biliare, rene
Intestini, Stomaco
Urologia
Retto
Ginecologia
Ostetrica
Dermatologia, Igiene
Vassoi diversi
Elettrochirurgia

Die Firma REDA Instrumente GmbH wurde im September 1990 gegründet. Ziel der Firmengründung war die Herstellung und der Vertrieb von chirurgischen Instrumenten.

Von anfangs 3 Mitarbeitern ist die Firma REDA innerhalb von sechs Geschäftsjahren zu einem mittelständischen Unternehmen gewachsen. Die Betriebsgröße beträgt heute mehr als 30 Mitarbeiter. Firma REDA exportiert in fast alle Länder der Welt und stellt dem Kunden weltweit Produkte und Dienstleistungen mit hoher Qualität zur Verfügung. Die Erwartungen der Kunden sollen stets erfüllt werden.

Um dieses zu erreichen, sind zufriedene und motivierte Mitarbeiter notwendig. Aus diesem Grund besitzen alle Mitarbeiter einen hohen Grad an Selbständigkeit und Eigenverantwortung für das Unternehmen. Darüber hinaus wird der familiäre Charakter seitens der Geschäftsführung unterstrichen und gefördert.

Der partnerschaftliche Stil setzt sich auch im hohen Maße bei den Geschäftsbeziehungen mit unseren Lieferanten und Kunden durch. Ziel ist es, Fehler zu vermeiden und kostenbewußt zu handeln.

Durch den Aufbau und den Unterhalt eines Qualitätsmanagementsystems nach den GMP regulation of the FDA, der DIN ISO 13485, Richtlinie 93/42 und die Zertifizierung des Systems wollen wir die erreichte Marktposition und Wettbewerbsfähigkeit halten und in der Zukunft weiter ausbauen.

In Zusammenarbeit mit Ärzten entwickeln, fertigen und vertreiben wir in den Bereichen:

- Allgemein- und Viszeralchirurgie
- Gefäß-, Mikro- und Neurochirurgie
- Herz- und Thoraxchirurgie
- Gynäkologie und Urologie
- HNO, Ophthalmologie
- Orthopädie
- Plastische Chirurgie
- Laparoskopie
- Endo-Neurochirurgie
- Arthroskopie
- Sinuskopie
- Cystoskopie
- Hysteroskopie
- Gynäkologie

Sehr gut ausgebildetes Personal und ein umfassender Maschinenpark ermöglichen es uns, die hohe Qualität und Präzision unserer Produkte umzusetzen und zu erreichen.

Unsere moderne EDV und die schlanke Organisation sind die wichtigsten Bestandteile unserer hohen Produktivität. Dadurch können wir unseren Kunden stets eine hohe Lieferbereitschaft und Flexibilität garantieren.

REDA Instrumente GmbH
Deutschland - Tuttlingen, 01/2009

REDA INSTRUMENTS GmbH was founded in September 1990. Starting with just three employees, REDA has grown within six years to a company who now employs over thirty people while still retaining the values of a family run business, and we pride ourselves on our customer service.

REDA exports to countries all over the world, offering to their customers a full range of surgical instruments.

REDA has a first class quality management system built upon the regulations of the FDA. In 1997 we became registered to DIN ISO 13485 and EEC 93/42.

REDA are able to offer a complete range of surgical instruments covering all types of surgery, including:

- General and Visceral Surgery
- Micro- Neuro- and Vascular Surgery
- Heart and Thorax Surgery
- Gynaecology
- ENT, Ophtalmology
- Orthopaedics etc.
- Laparoscopy
- Endo-Neurosurgery
- Arthroscopy
- Urology
- Gynaecology

We strive to offer first class products, manufactured by our highly trained precision engineers using most up to date C & C machines.

At our modern offices, together with modern technology, we can offer our customers a fast and efficient service from our large stocked warehouse.

REDA Instrumente GmbH
Deutschland - Tuttlingen, 01/2009

REDA Instrumente GmbH fundada en 1990 en Tuttlingen, Alemania, comenzó con éxito y con la intención de ocupar un lugar de privilegio como líder en la fabricación y venta internacional de instrumentos quirúrgicos de calidad superior.

Nuestra compañía comenzó con un pequeño staff integrado por el grupo familiar y fué creciendo con paso firme contando en la actualidad con un personal capacitado de aproximadamente 30 operarios y con presencia internacional a través de sus distribuidores en las principales capitales del mundo.

Un gran porcentaje de nuestra producción se compone de productos solicitados bajo características y marcas de nuestros clientes.

Con el objetivo de asegurar nuestro alto nivel de calidad nuestra empresa mantiene un staff muy entusiasta acompañado de una integrada relación con la gerencia, independencia en el empleo y motivación propia para el bienestar del personal.

Nos satisface trabajar junto a nuestros proveedores y en busca de un claro objetivo que nos permita lograr mutuos beneficios. Estamos seguros que éste sistema de trabajo nos permite evitar errores y lograr una mejor manufacturación de nuestros productos, la mayoría de ellos se diseñan con la colaboración y asesoramiento de médicos profesionales.

Nuestras especialidades en cirugía incluyen instrumentos para:

- cirugía general y visceral
- cirugía vascular, microcirugía, neurocirugía
- cirugía cardiovascular
- ginecología y urología
- ORL, Oftalmología
- Ortopedia
- cirugía plástica
- Laparoscopia
- Endo-neurocirugía
- Atroscopia
- sinuscopia
- cistoscopia
- histeroscopia
- ginecología

Estamos orgullosos de nuestra calidad, manteniendo periódicamente los tests correspondientes de GMP que exigen los standards regulares de agencias tales como la FDA, contando con las certificaciones de DIN ISO 13485 and EEC 93/42.

Desde los inicios, a través de modernos equipos computarizados logramos producir solamente instrumental de alta calidad.

REDA Instrumente GmbH
Deutschland - Tuttlingen, 01/2009

La REDA Instrumente GmbH fondata nel 1990 a Tuttlingen in Germania incominciò con l'intenzione di produrre e vendere strumenti chirurgici di qualità superiore sul mercato internazionale.

La nostra ditta incominciò con uno staff di 3 persone che attualmente è cresciuto a circa 30 persone con una presenza internazionale in tutti i paesi del mondo.

Una grande percentuale della nostra produzione è composta di prodotti richiesti a base caratteristiche e con il marchio dei nostri clienti.

Per poter assicurare il nostro alto livello di qualità la nostra impresa tiene uno staff molto entusiasta accompagnato da una relazione con la direzione, l'indipendenza e la propria motivazione per il benessere del personale.

Noi desideriamo lavorare in relazioni commerciali fra il fornitore ed il cliente, quale ci permette di ottenere un effetto utile reciproco. Siamo sicuri che questo tipo di collaborazione aiuta a limitare malintesi ed errori nella produzione e fornitura dei nostri prodotti. La maggiore parte dei nostri prodotti vengono sviluppati con la collaborazione di chirurghi professionali.

Le nostre specialità nella chirurgia includono strumenti per:

- Chirurgia generale e viscerale
- Micro chirurgia, neurochirurgia, chirurgia per vasi
- Chirurgia cardiovascolare e toracica
- Ginecologia e urologia
- ENT, oftalmologia
- Ortopedia
- Chirurgia plastica
- Laparoscopia
- Endo neurochirurgia
- Artroscopia
- Sinuscopia
- Cistoscopia
- Isteroscopia
- Ginecologia

Siamo orgogliosi della nostra qualità mantenuta periodicamente con i test corrispondenti agli standard GMP che mantengono o superano gli standard regolari come tali della FDA, la certificazione DIN ISO 13485 and EEC 93/42. Il nostro sistema moderno computerizzato ci permette di produrre solamente strumenti di alta qualità.

REDA Instrumente GmbH
Deutschland - Tuttlingen, 01/2009

Blutdruckmeßgeräte
Sphygmomanometer
Esfigmomanómetros
Sfigmomanometri

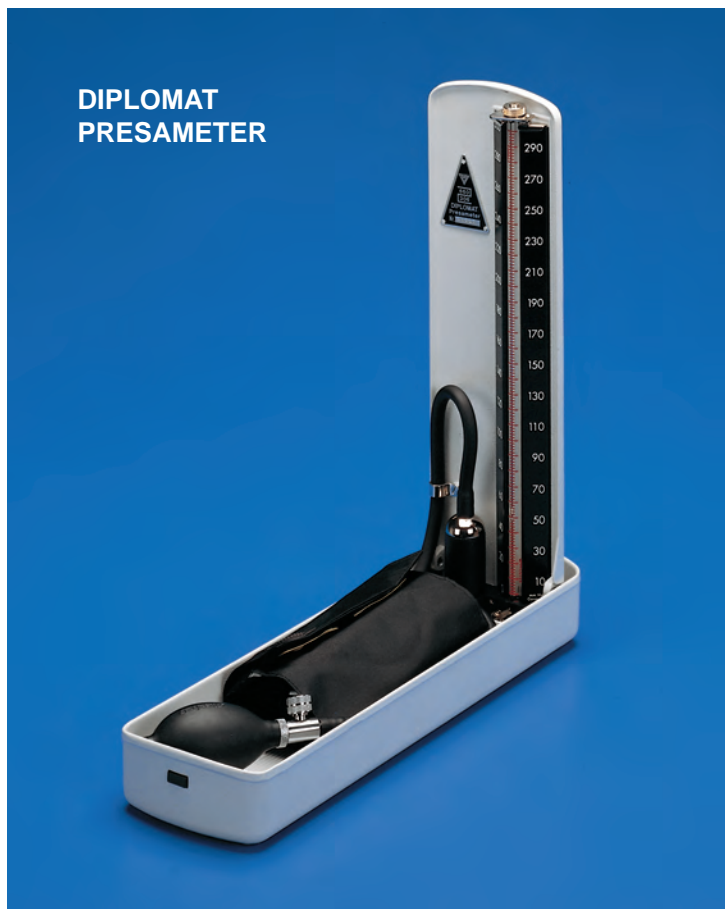

**DIPLOMAT
PRESAMETER**

Preiswertes und sehr beliebtes Quecksilbergerät in Metalletui. Lichtgraue Kunststoffbeschichtung. Glasröhre von höchster Präzision mit Innendurchmesser 4,2 mm +/- 0,2 mm. Gute Ablesbarkeit der eloxierten Skala bis 300 mmHG. Vernickelte Metallteile. Mit Quecksilbersicherung. Maximale Fehlertoleranz des Gerätes: +/- 3 mmHg. Mit Latexball und verchromtem Ablassventil.

Nr. 03112-00 - Mit Wickelmanschette aus Baumwolle komplett mit Latexpolster 2-Schlauch.

Nr. 03112-01 - Mit Hakenmanschette aus Baumwolle komplett mit Latexpolster 2-Schlauch.

Nr. 03112-02 - Mit kalibrierter Nylon-Velcromanschette komplett mit Latexpolster 2-Schlauch.

Economical and attractive mercurial sphygmomanometer in metal case. Enamelled in light gray color. Precision glass tube with inside diameter 4,2 mm +/- 0,2 mm. Anodized faceplate with easy-to-read graduated scale. Maximum reading 300 mmHg. Nickel-plated metal parts. Mercury lock. Maximum error throughout range +/- 3 mmHg. Complete with latex bulb and chrome-plated air-release valve.

No. 03112-00 - With cotton bandage cuff complete with 2-tube latex bladder.

No. 03112-01 - With cotton hook cuff complete with 2-tube latex bladder.

No. 03112-02 - With calibrated nylon velcro complete with 2-tube latex bladder.

Tensiómetro de mercurio económico y de una gran difusión en estuche metálico. Recubierto con plástico de color gris claro. Tubo vidrio de máxima precisión con diámetro interior de 4,2 mm +/- 0,2 mm. Lectura cómoda en la escala anodizada hasta 300 mmHg. Partes metálicas niqueladas. Tiene cierre de seguridad en el depósito de mercurio. Tolerancia de errores máxima del aparato +/- 3 mmHg. Pera latex y válvula cromada.

No. 03112-00 - Con brazalete de venda de algodón, completo, bolsa latex de 2 tubos.

No. 03112-01 - Con brazalete de ganchos de algodón, completo, con bolsa latex de 2 tubos.

No. 03112-02 - Con brazalete velcro de nilón, calibrado, completo con bolsa latex de 2 tubos.

Sfigmomanometro a mercurio economico ed elegante in astuccio di metallo. Verniciato in grigio chiaro. Colonna di precisione di vetro con diametro interno 4,2 mm +/- 2 mm. Quadrante anodizzato con scala graduata di facile lettura. Valore massimo 300 mmHg. Parti metalliche nichelate. Chiusura di sicurezza del mercurio. Tolleranza +/- 3 mmHg. Completo di monopalla in latex e valvola di sfiato cromata.

No. 03112-00 - Con bracciale di cotone a fascia, completo di camera d'aria in latex a due tubi.

No. 03112-01 - Con bracciale di cotone a ganci, completo di camera d'aria in latex a due tubi.

No. 03112-02 - Con bracciale calibrato velcro-nylon completo di camera d'aria in latex a due tubi.

Blutdruckmeßgeräte
Sphygmomanometer
Esfigmomanómetros
Sfigmomanometri



Qualitativ sehr hochwertiges Quecksilbergerät in Metallgehäuse mit 2-farbiger Einbrennlackierung (hellgrau und schwarz). Glasröhre von höchster Präzision mit Innendurchmesser 4,2 mm +/- 0,2 mm. Gute Ablesbarkeit der eloxierten Skala bis 300 mmHg. Verchromte Metallteile. Mit Quecksilbersicherung und Ballhalterung. Maximale Fehlertoleranz des Gerätes: +/- 3 mmHg. Mit Latexball und verchromtem Ablassventil.

Nr. 03113-00 - Mit Wickelmanschette aus Baumwolle komplett mit Latexpolster 2-Schlauch.

Nr. 03113-01 - Mit Hakenmanschette aus Baumwolle komplett mit Latexpolster 2-Schlauch.

Nr. 03113-02 - Mit kalibrierter Nylon-Velcromanschette komplett mit Latexpolster 2-Schlauch.

High quality extra-sturdy mercurial sphygmomanometer in metal case. Enamelled in light gray with contrasting trim. Precision glass tube with inside diameter 4,2 mm +/- 0,2 mm. Anodized faceplate with easy-to-read graduated scale. Maximum reading 300 mmHg. Chrome-plated metal parts. Mercury lock. Bulb holder. Maximum error throughout range +/- 3 mmHg. With latex bulb and chrome-plated air release valve.

No. 03113-00 - With cotton bandage cuff complete with 2-tube latex bladder.

No. 03113-01 - With cotton hook cuff complete with 2-tube latex bladder.

No. 03113-02 - With calibrated nylon velcro complete with 2-tube latex bladder.

Tensiómetro de mercurio de alta calidad en estuche metálico barnizado al fuego en gris claro y negro. Tubo vidrio de precisión máxima con diámetro interior de 4,2 mm +/- 0,2 mm. Cómoda lectura de la escala anodizada hasta 300 mmHg. Partes metálicas cromadas. El depósito de mercurio lleva un cierre de seguridad. Soporte para pera. Tolerancia de errores máxima del aparato +/- 3 mmHg. Con pera latex y válvula cromada.

No. 03113-00 - Con brazalete de venda de algodón completo, con bolsa latex con 2-tubos.

No. 03113-01 - Con brazalete de ganchos de algodón completo, con bolsa latex con 2-tubos.

No. 03113-02 - Con brazalete velcro de nilón calibrado completo, con bolsa latex con 2-tubos.

Sfigmomanometro a mercurio di alta qualità, molto robusto, in astuccio di metallo, verniciato in grigio chiaro con eleganti rifiniture. Colonna di precisione di vetro con diametro interno 4,2 mm +/- 2 mm. Quadrante anodizzato con scala graduata di facile lettura. Valore massimo 300 mmHg. Parti metalliche cromate. Chiusura di sicurezza del mercurio. Supporto per monopalla. Tolleranza +/- 3 mmHg. Con monopalla in latex e valvola di sfiato cromata.

No. 03113-00 - Con bracciale di cotone a fascia completo di camera d'aria di latex a 2-tubi.

No. 03113-01 - Con bracciale di cotone a ganci completo di camera d'aria di latex a 2-tubi.

No. 03113-02 - Con bracciale calibrato velcro-nylon completo di camera d'aria di latex a 2-tubi.

Blutdruckmeßgeräte
Sphygmomanometer
Esfigmomanómetros
Sfigmomanometri

NOVA WANDMODELL

Quecksilbergerät von höchster Qualität, ideal für Praxis und Klinik. Nicht schwenkbar. Lichtgrau kunststoffbeschichtete Metallplatte. Glasröhre von höchster Präzision mit Innendurchmesser 4,2 mm +/- 0,2 mm. Gute Ablesbarkeit der eloxierten Skala bis 300 mmHg. Verchromte Metallteile. Quecksilbersicherung. Kunststoffbeschichteter Metallkorb zur optimalen Aufbewahrung des Zubehörs. Spiralschlauch dehnbar bis zu 3 m. Maximale Fehlertoleranz des Gerätes: +/- 3 mmHg. Mit Latexball und verchromtem Ablaufventil. Befestigungsschrauben und Dübel werden mitgeliefert.

Nr. 03114-00 - Mit Wickelmanschette aus Baumwolle komplett mit Latexpolster 2-Schlauch.

Nr. 03114-01 - Mit Hakenmanschette aus Baumwolle komplett mit Latexpolster 2-Schlauch.

Nr. 03114-02 - Mit kalibrierter Nylon-Velcromanschette komplett mit Latexpolster 2-Schlauch.

High quality mercurial sphygmomanometer ideal for use in hospitals and physicians' offices. Non-swiveling metal housing enameled in light gray. Precision glass tube with inside diameter 4,2 mm +/- 0,2 mm. Anodized faceplate with easy-to-read graduated scale. Maximum reading 300 mmHg. Chrome-plated metal parts. Mercury lock. Plastic coated metal basket for convenient accessory storage. Coiled tubing extensible to 3 m. Maximum error throughout range +/- 3 mmHg. With latex bulb and chrome-plated air-release-valve. Mounting hardware included.

No. 03114-00 - With cotton bandage cuff complete with 2-tube latex bladder.

No. 03114-01 - With cotton hook cuff complete with 2-tube latex bladder.

No. 03114-02 - With calibrated nylon velcro cuff complete with 2-tube latex bladder.

Tensiómetro de mercurio de alta calidad y fiabilidad, ideal para consultorios y clínicas. Fijo, no movable. Placa metal recubierta plástico de color gris claro. Tubo vidrio de precisión máxima y diámetro interior de 4,2 mm +/- 0,2 mm. Cómada lectura de la escala anodizada hasta 300 mmHg. Partes metálicas cromadas. Con cierre de seguridad en el depósito de mercurio. Cestillo metálico recubierto de plástico para la colocación del accesorio. Con tubo espiral extensible hasta 3 metros. Tolerancia de errores máxima del aparato: +/- 3 mmHg. Con pera latex y válvula cromada. Se incluyen tacos y tornillos para la sujeción.

No. 03114-00 - Con brazaletes de venda de algodón completo con bolsa latex con 2 tubos.

No. 03114-01 - Con brazaletes de ganchos de algodón completo con bolsa latex con 2 tubos.

No. 03114-02 - Con brazaletes velcro de nilón calibrado completo con bolsa latex con 2 tubos.

Sfigmomanometro a mercurio di alta qualità, ideale per ospedali ed ambulatori. Corpo dell'apparecchio in metallo, non orientabile, verniciato in grigio chiaro. Colonna di precisione di vetro con diametro interno 4,2 mm +/- 0,2 mm. Quadrante anodizzato con scala graduata di facile lettura. Valore massimo 300 mmHg. Parti metalliche cromate. Chiusura di sicurezza del mercurio. Cestello porta accessori in metallo rivestito di plastica. Tubo a spirale estensibile fino a 3 m. Tolleranza +/- 3 mmHg. Con monopalla in latex e valvola di sfogo cromata. Fornito con accessori di montaggio.

No. 03114-00 - Con bracciale di cotone a fascia completo di camera d'aria di latex a 2-tubi.

No. 03114-01 - Con bracciale di cotone a ganci completo di camera d'aria di latex a 2-tubi.

No. 03114-02 - Con bracciale calibrato velcro-nylon completo di camera d'aria di latex a 2-tubi.



Blutdruckmeßgeräte
Sphygmomanometer
Esfigmomanómetros
Sfigmomanometri



EXACTA-SPEZIAL

Noch modernere Ausführung unseres bisherigen sehr bekannten und beliebten Exacta Manometers. Sehr interessant im Preis. Metallgehäuse, schwarz einbrennlackiert. Mit spezialgehärteter Kupfer-Beryllium Membrane. Keine Nullpunktfixierung. Gut ablesbare Aluminiumskala \varnothing 49 mm bis 300 mmHg. Metalklemme an der Rückseite des Manometers zum Einhängen an der Manschette. Mit Latexball und verchromtem Ablaßventil. In Vinyltasche mit Reißverschluss. Maximale Fehlertoleranz des Gerätes: \pm 3 mm Hg.
No. 03120-00 - Mit kalibrierter Nylon-Velcromanschette komplett mit Latexpolster 2-Schlauch.

Latest version of our well-known Exacta classic sphygmomanometer, with an especially attractive price. Metal housing with baked-on black enamel finish. Special tempered copper-beryllium diaphragm. No stop pin. Easy-to-read graduated aluminium scale 49 mm \varnothing . Maximum reading 300 mmHg. Clip on rear of manometer for attachment to cuff. With latex bulb and chrome-plated air release valve, in vinyl zipper case. Maximum error \pm 3 mmHg throughout range.
No. 03120-00 - With calibrated nylon-velcro cuff complete with 2-tube latex bladder.

Modelo más moderno que nuestro anterior Exacta manómetro muy popular y conocido. Con precio muy económico. Caja metálica barnizada al fuego de color negro. Con membrana cobreberilio endurecido especial. Sin fijación a cero. Buena lectura de la escala aluminio \varnothing 49 mm hasta 300 mmHg. Con pinza metálica a la parte posterior del manómetro para ganchar en el brazalete. Con pera de latex y válvula cromada. En estuche de vinyl con cierre de cremallera. Tolerancia de errores máxima del aparato: \pm 3 mmHg.
No. 03120-00 - Con brazalete velcro de nilón calibrado completo con bolsa de latex con 2 tubos.

La più recente versione dei famosi sfigmomanometri tradizionali Exacta, ad un prezzo veramente interessante. Realizzato in metallo rifinitura smaltata a forno. Membrana speciale di rame-berillio indurito. Senza fissaggio a zero. Scala graduata in alluminio \varnothing 49 mm di facile lettura. Valore massimo 300 mmHg. Con morsetto nella parte posteriore del manometro per l'attacco al bracciale. Monopalla di latex e valvola di sfiato cromata. Fornito in borsa di vinilpelle con cerniera lampo. Tolleranza \pm 3 mmHg.
No. 03120-00 - Con bracciale calibrato velcro-nylon completo di camera d'aria di latex a 2 tubi.

Blutdruckmeßgeräte
Sphygmomanometer
Esfigmomanómetros
Sfigmomanometri



Sehr preisgünstiges, modernes und beliebtes Einhandmodell. Stabiles Kunststoffgehäuse, schwarz. Spezialgehärteter Kupfer-Beryllium Membrane. Keine Nullpunktfixierung. Gut ablesbare Aluminiumskala \varnothing 63 mm bis 300 mmHg. Löffel aus rostfreiem Stahl. Mit Latexpolster und verchromtem Ablassventil. Mit verchromter Schlauchverschraubung auf der rechten Seite unterhalb des Manometers. In Vinyltasche mit Reißverschluss. Maximale Fehlertoleranz des Gerätes: \pm 3 mmHg.

No. 03122-00 - Mit kalibrierter Nylon-Velcromanschette komplett mit Latexpolster 1-Schlauch.

Very attractive and economical modern palm-style sphygmomanometer. Black housing of engineering plastic with chrome-plated tube connection at lower right. Special tempered copper-beryllium diaphragm. No stop pin. Easy-to-read graduated aluminium scale \varnothing 63 mm. Maximum reading 300 mmHg. Stainless steel handle. With latex bulb and chrome-plated air release valve, in vinyl zipper case. Maximum error \pm 3 mmHg throughout range.

No. 03122-00 - With calibrated nylon-velcro cuff complete with 1-tube latex bladder.

Modelo de mano, muy económico, moderno y popular. Estuche plástico duro de color negro. Con membrana cobre-berilio endurecido especial. Sin fijación a cero. Buena lectura de la escala de aluminio \varnothing 63 mm hasta 300 mmHg. Con cuchara de acero inoxidable. Con pera de latex y válvula cromada. Con atornilladura de tubo cromada al lado derecho debajo del manómetro. En estuche de vinilo con cierre de cremallera. Tolerancia de errores máxima del aparato: \pm 3 mmHg.

No. 03122-00 - Con brazalete velcro de nilón, calibrado, completo con bolsa de latex con 1 tubo.

Sfigmomanometro molto elegante, moderno ed economico. Modello a mano. Scatola del manometro in materiale sintetico robusto con uscita laterale cromata per collegamento del tubo (in basso a destra). Membrana speciale in rame-berillio indurito. Senza fissaggio a zero. Scala graduata in alluminio di facile lettura, \varnothing 63 mm. Valore massimo 300 mmHg. Manico in acciaio inossidabile. Con monopalla di latex, valvola di sfiato cromata. Fornito in borsa di vinilpelle con chiusura lampo. Tolleranza \pm 3 mmHg.

No. 03122-00 - Con bracciale calibrato velcro-nylon completo di camera d'aria di latex add 1 tubo.

Blutdruckmeßgeräte
Sphygmomanometer
Esfigmomanómetros
Sfigmomanometri



BABYPHON

Einhandblutdruckmessgerät, besonders geeignet für Kinderarztpraxen. Wurde speziell in der kinderfreundlichen Farbe blau gestaltet. Verchromtes Metallgehäuse. Spezialgehärtete Kupfer-Beryllium Membrane. Keine Nullpunktfixierung. Gut ablesbare blau-weiße Aluminiumskala \varnothing 49 mm bis 300 mmHg. Löffel aus rostfreiem Stahl. Blauer Weichkunststoffball und verchromtes Ablaufventil. Verchromte Schlauchverschraubung am Manometeroberteil. In blauer Kunstledertasche mit Reißverschluss. Maximale Fehlertoleranz: \pm 3 mmHg. Komplet mit 3 verschiedenen blauen, kalibrierten Nylon-Velcro-Manschetten, mit Latexpolster 1-Schlauch. Alle Manschetten werden mit besonders kinderfreundlichem Bäreindruck geliefert.

Nr. 03126-00 - Komplettes Set mit 3 austauschbaren Manschetten mit Metallkonnektoren.
Neugeborene: 15,5 x 5,0 cm - Säuglinge: 23,0 x 7,2 cm - Kinder: 35,5 x 10,0 cm

Modern palm-model sphygmomanometer specially designed for pediatric use. Interchangeable cuffs equipped with metal tube connectors for quick and reliable attachment to unit of cuff appropriate to age of patient. Scale, bulb, cuffs, and case in attractive light blue color, with cuffs printed with child-friendly bear motif. Chrome-plated metal housing with tube connection at top. Stainless steel handle. Special tempered copper-beryllium diaphragm. No stop pin. Easy-to-read graduated manometer scale \varnothing 49 mm. Maximum reading 300 mmHg. With soft plastic bulb, chrome-plated air-release valve, and set of three interchangeable cuffs, in leatherette zipper case. Maximum error \pm 3 mmHg throughout range.

No. 03126-00 - Complete with set of three interchangeable cuffs with metal connectors.
Newborn: 15,5 x 5,0 cm - Infant: 23,0 x 7,2 cm - Child: 35,5 x 10,0 cm

Tensiómetro a mano, apropiado especialmente p. consultorios de pediatra. Se fabrica en color azul, agradable p. niños. Estuche metálico cromado. Membrana cobre-berilio endurecido especial. Sin fijación a cero. Buena lectura de la escala aluminio de colores azul y blanco \varnothing 49 mm hasta 300 mmHg. Cuchara de acero inoxidable. Pera de hule de plástico suave azul. Válvula cromada. Atornilladura de tubo cromada a la parte superior del manómetro. En estuche de cuero artificial, azul. c. cierre de cremallera. Tolerancia de errores máxima: \pm 3 mmHg. 3 brazaletes velcro de nilón, calibrados, con bolsas latex, 1 tubo de tamanos diferentes de color azul. Los tres brazaletes llevan impreso unos osos especialmente atractivo p. niños.

No. 03126-00 - Juego, completo con 3 brazaletes intercambiables con conectores metálicos.
Recien nacidos: 15,5 x 5,0 cm - Lactantes: 23,0 x 7,2 cm - Niños: 35,5 x 10,0 cm

Sfigmomanometro moderno, modello a mano, per uso pediatrico. Bracciali intercambiabili correati di connettori di metallo per un veloce e sicuro attacco all'apparecchio del bracciale più adatto all'età del paziente. Scala graduata, monopalla, bracciali e astuccio di colore azzurro. Bracciali con stampato motivo adatto per bambini. Manometro cromato con uscita per collegamento tubo nella parte superiore. Manico in acciaio inossidabile. Membrana speciale in rame-berillio indurito. Senza fissaggio a zero. Scala graduata del manometro \varnothing 49 mm di facile lettura. Valore massimo 300 mmHg. Monopalla in plastica morbido, valvola di sfianto cromata e set di 3 bracciali intercambiabili in astuccio di finta pella con cerniera lampo. Tolleranza \pm 3 mmHg.

Nr. 03126-00 - Comprende set di 3 bracciali intercambiabili con raccordi di metallo.
Neonati: 15,5 x 5,0 cm - Bambini piccoli: 23,0 x 7,2 cm - Bambini: 35,5 x 10,0 cm

Blutdruckmeßgeräte
Sphygmomanometer
Esfigmomanómetros
Sfigmomanometri



MINIMUS II

Weltweit bekanntes und überaus beliebtes Einhandmodell. Verchromtes Metallgehäuse. Spezialgehärtete Kupfer-Beryllium Membrane. Keine Nullpunktfixierung. Gut ablesbare Aluminiumskala \varnothing 49 mm bis 300 mmHg. Löffel aus rostfreiem Stahl. Mit Latexball und verchromtem Ablassventil. Mit verchromter Schlauchverschraubung am Manometeroberteil. In Vinyltasche mit Reißverschluss. Maximale Fehlertoleranz des Gerätes: \pm 3 mmHg.

Nr. 03132-00 - Mit Wickelmanschette aus Baumwolle komplett mit Latexpolster 1-Schlauch.

Nr. 03132-01 - Mit Hakenmanschette aus Baumwolle komplett mit Latexpolster 1-Schlauch.

Nr. 03132-02 - Mit kalibrierter Nylon-Velcromanschette komplett mit Latexpolster 1-Schlauch.

World-famous palm-style aneroid sphygmomanometer. Chrome-plated metal housing. Special tempered copper-beryllium diaphragm. No stop pin. Easy-to-read graduated aluminum scale 49 mm \varnothing . Maximum reading 300 mmHg. Stainless steel handle. With latex bulb and chrome-plated air release valve. In vinyl zipper case. Maximum error \pm 3 mmHg throughout range.

No. 03132-00 - With cotton bandage cuff, complete with 1-tube latex bladder.

No. 03132-01 - With cotton hook cuff, complete with 1-tube latex bladder.

No. 03132-02 - With calibrated nylon-velcro cuff, complete with 1-tube latex bladder.

Modelo de mano, de fama mundial y preferido por los medicos. Caja metálica cromada donde se aloja el mecanismo. Con membrana cobre-berilio endurecido especial. Sin fijación a cero. Buena lectura de la escala de aluminio \varnothing 49 mm hasta 300 mmHg. Con cuchara de acero inoxidable. Con pera latex y válvula cromada. Con atornilladura de tubo cromada a la parte superior del manómetro. En estuche de vinilico con cierre de cremallera. Tolerancia máxima del aparato: \pm 3 mmHg.

No. 03132-00 - Con brazalete de venda de algodón completo con bolsa de latex con 2 tubos.

No. 03132-01 - Con brazalete de ganchos de algodón completo con bolsa de latex con 2 tubos.

No. 03132-02 - Con brazalete velcro de nilón calibrado completo con bolsa de latex con 2 tubos.

Sfigmomanometro ad aneroido, modello a mano di fama mondiale. Manometro cromato con uscita per collegamento tubo cromata, nella parte superiore. Membrana speciale di rame-berillio indurito. Senza fissaggio a zero. Scala graduata in alluminio \varnothing 49 mm di facile lettura. Valore massimo 300 mmHg. Manico in acciaio inossidabile. Con monopalla di latex e valvola di sfianto cromato. Fornito in borsa vinilpelle con cerniera lampo. Tolleranza \pm 3 mmHg.

No. 03132-00 - Con bracciale di cotone a fascia completo di camera d'aria latex ad 1 tubo.

No. 03132-01 - Con bracciale di cotone a ganci completo di camera d'aria di latex ad 1 tubo.

No. 03132-02 - Con bracciale calibrato velcro-nylon completo di camera d'aria di latex ad 1 tubo.

Blutdruckmeßgeräte
Sphygmomanometer
Esfigmomanómetros
Sfigmomanometri



MINIMUS III

Weltweit bekanntes und beliebtes Einhandmodell. Verchromtes Metallgehäuse. Spezialgehärtete Kupfer-Beryllium Membrane. Keine Nullpunktfixierung. Gut ablesbare Aluminiumskala \varnothing 49 mm bis 300 mmHg. Löffel aus rostfreiem Stahl. Latexpolster und verchromtes Ablaufventil. Zwei verchromte Schlauchverschraubungen an der rechten Seite unterhalb des Manometers. In Vinyltasche mit Reißverschluss. Maximale Fehlertoleranz des Gerätes: \pm 3 mmHg.

Nr. 03133-00 - Mit Wickelmanschette aus Baumwolle, komplett mit Latexpolster mit Doppelschlauch.

Nr. 03133-01 - Mit Hakenmanschette aus Baumwolle, komplett mit Latexpolster mit Doppelschlauch.

Nr. 03133-02 - Mit kalibrierter Nylon-Velcromanschette, komplett mit Latexpolster mit Doppelschlauch.

World-famous and popular palm-style sphygmomanometer. Chrome-plated metal housing with 2 chromed-tube connections at lower right. Special tempered copper-beryllium diaphragm. No stop pin. Easy-to-read graduated aluminium scale \varnothing 49 mm. Maximum reading 300 mmHg. Stainless steel handle. With latex bulb and chrome-plated air release valve. In vinyl zipper case. Maximum error \pm 3 mmHg throughout range.

No. 03133-00 - With cotton bandage cuff, complete with double-tube latex bladder.

No. 03133-01 - With cotton hook cuff, complete with double-tube latex bladder.

No. 03133-02 - With calibrated nylon velcro cuff complete with double-tube latex bladder.

Modelo de mano, conocido en el mundo entero y de gran aceptación. Caja metálica cromada donde se aloja el mecanismo. Membrana cobre-berilio endurecido especial. Sin fijación a cero. Buena lectura de la escala aluminio \varnothing 49 mm hasta 300 mmHg. Cuchara de acero inoxidable. Pera latex y válvula cromada. Dos atomilladuras de tubo cromadas al lado derecho debajo del manómetro. En estuche vinílico con cierre cremallera. Tolerancia de errores máxima: \pm 3 mmHg.

No. 03133-00 - Con brazalete de venda de algodón, completo con bolsa de latex doble tubos.

No. 03133-01 - Con brazalete de ganchos de algodón, completo con bolsa de latex doble tubos.

No. 03133-02 - Con brazalete velcro de nilón calibrado, completo con bolsa de latex doble tubos.

Sfigmomanometro ad aneroide di fama mondiale. Manometro in metallo cromato con uscita cromata laterale (in basso a destra) per collegamento a due tubi. Membrana speciale di rame-berillio indurito. Senza fissaggio a zero. Scala graduata in alluminio \varnothing 49 mm di facile lettura. Valore massimo 300 mmHg. Manico in acciaio inossidabile. Con monopalla di latex e valvola di sfiato cromata. Fornito in borsa vinilpelle con cerniera lampo. Tolleranza \pm 3 mmHg.

No. 03133-00 - Con bracciale di cotone a fascia, completo di camera d'aria di latex a 2 tubi.

No. 03133-01 - Con bracciale di cotone a ganci, completo di camera d'aria di latex a 2 tubi.

No. 03133-02 - Con bracciale calibrato velcro-nylon completo di camera d'aria a 2 tubi.

Diagnostik-Bestecke mit Standardbeleuchtung
 Diagnostic Sets with Standard illumination
 Estuches de diagnóstico con iluminación standard
 Combinazioni per diagnostica con illuminazione standard



Nr. 03161-00

Weltbekanntes und preiswertes Otoskop mit Standardbeleuchtung 2,5 V. Besonders geeignet für Studenten und Ärzte.

Set bestehend: Aus **Otoskopkopf** verchromt, mit Steckverschluss. **Verchromter Batteriegriff 28 mm ø** für 2 Batterien Typ C. Mit abnehmbarem Abdeckglas in Kunststoff-Fassung mit Plastikconnector für den pneumatischen Test. Die verchromte Schwenklinse ist abnehmbar und vergrößert 4,0-fach. Die Lichtstärke kann anhand des Rheostates reguliert werden. Mit 3 wiederverwendbaren Ohrtrichtern 2, 3 und 4 mm ø. Komplett in silberfarbener Kunststofftasche.

No. 03161-00

World famous otoscope set at a budget price for physicians and students. 2,5 V standard illumination for use with 2 batteries type C.

Set includes: **Otoscope head** with pin contact fitting. Chrome-plated. Fixed protective lens in plastic mount may be removed for introduction of instruments. Plastic connector for pneumatic otoscopy. Removable swivel-mounted 4 x magnifier. 2, 3 and 4 mm reusable specula included. **Battery handle 28 mm ø** for 2 C-cell batteries. Chrome-plated. With thumb wheel for securing pin contact heads. With rheostat for adjustment of illumination. Complete in silver-colored plastic pouch.

No. 03161-00

Otoscopio muy popular y económico con iluminación standard 2,5 V apropiado para estudiantes y médicos, de fama mundial.

Cabeza otoscopio cromada, con cierre de tornillo. **Mango a pilas cromado 28 mm ø** para dos pilas tipo C. Con cristal de cubierto desmontable en armadura plástica. Con conector plástico para el test neumático. La lente giratoria es desmontable y amplifica 4,0 veces mas. La intensidad de la luz es regulable con el reostato. Con tres especulos reutilizables 2, 3 y 4 mm ø. Completo en bolsa de plástico de color gris plata.

No. 03161-00

Combinazione otoscopio molto conosciuta, ad un prezzo economico, per ambulatori e studenti. Illuminazione standard 2,5 V con 2 batterie tipo C.

La combinazione comprende: **Testa otoscopio** con chiusura a vite. Cromata. La lente di protezione fissa in supporto di plastica può essere tolta per l'inserimento di strumenti. Connettore di plastica per test pneumatico. Lente d'ingrandimento 4 x in montatura girevole estraibile. Inclusi specoli riusabili da 2, 3 e 4 mm. **Manico a pila ø 28 mm** per 2 batterie tipo C. Cromato. Con ruota ad orlo zigrinato per fissare la testa dell'otoscopio con chiusura a vite. Con reostato per la regolazione dell'illuminazione. Fornito in busta di plastica colore grigio argento.

Diagnostik-Bestecke mit Standardbeleuchtung
 Diagnostic Sets with Standard illumination
 Estuches de diagnóstico con iluminación standard
 Combinazioni per diagnostica con illuminazione standard



Nr. 03161-01

Weltbekanntes und preisgünstiges **May-Ophthalmoskop**: mit Standardbeleuchtung 2,5 V. Besonders für Studenten und Ärzte geeignet. Ophthalmoskop mit Steckverschluß. Anhand des Linsenrades können Korrekturlinsen von 0 bis +20 und 0 bis -20 Dioptrien gewählt werden. Mit einer Blende: großer Kreis. Mit verchromtem **Batteriegriff**: 28 mm \varnothing für 2 Batterien Typ C. Die Lichtstärke kann anhand des Rheostates reguliert werden. Komplett in silbergrauer Kunststofftasche.

No. 03161-01

World-famous ophthalmoscope set at a budget price for physicians and students. 2,5 V standard illumination for use with 2 batteries Type C. Set includes: **May ophthalmoscope head**: Pin contact fitting. Lens selection wheel permits choice of corrective lenses from 0 to +20 and 0 to -20 diopters. Single large circle aperture. **Battery handle**: 28 mm \varnothing for 2 C-cell batteries. Chrome-plated. With thumb wheel for securing pin-contact heads. Rheostat for adjustment of illumination. Complete in silver-gray plastic pouch.

No. 03161-01

Oftalmoscopio May: muy popular y económico con iluminación standard 2,5 V, apropiado para estudiantes y médicos de fama mundial. Oftalmoscopio con cierre de tornillo. Con ayuda de la rueda de lentes se puede elegir lentes de corrección de 0 a +20 y o a -20 dioptrías. Y con una apertura: gran círculo. Con **mango a pilas**: cromado 28 mm \varnothing para dos pilas tipo C. La intensidad de la luz es regulable con el reostato. Completo en bolsa de plástico de color gris plata.

No. 03161-01

Combinazione oftalmoscopio molto conosciuta, a prezzo economico, per ambulatori e studenti. Illuminazione standard 2,5 V con 2 batterie tipo C. La combinazione comprende: **Oftalmoscopio di May**: Con chiusura a vite. La rotella di selezione delle lenti permette la scelta di lenti di correzione da 0 a +20 e da 0 a -20 diottrie. Apertura singola a cerchio grande. **Manico a pila**: \varnothing 28 mm per 2 batterie tipo C. Cromato. Con ruota ad orlo zigrinato per fissare la testa dell'otoscopio con chiusura a vite. Reostato per la regolazione dell'illuminazione. Fornito con busta di plastica di colore grigio argento.

Diagnostik-Bestecke mit Standardbeleuchtung
 Diagnostic Sets with Standard illumination
 Estuches de diagnóstico con iluminación standard
 Combinazioni per diagnostica con illuminazione standard



Nr. 03161-02

Weltbekanntes diagnostisches Besteck mit Standardbeleuchtung 2,5 V. Äußerst beliebt und sehr preiswert. Besonders geeignet für Studenten und Ärzte. Das Set besteht aus folgenden Teilen: **Otoskopkopf** verchromt, mit Steckverschluß. Abnehmbares Abdeckglas in Kunststofffassung, mit Plastikconnector für pneumatischen Test. Abnehmbarer Schwenklinse (Vergrößerung 4,0-fach). 3 wiederverwendbaren Ohrtrichtern 2, 3 und 4 mm \varnothing . **May-Ophthalmoskop** mit Steckverschluß. Anhand des Linsenrades können Korrekturlinsen von 0 bis +20 und 0 bis -20 Dioptrien gewählt werden. Mit einer Blende: großer Kreis. **Batteriegriff** verchromt, 28 mm \varnothing für 2 Batterien Typ C. Die Lichtstärke kann anhand des Rheostates am Batteriegriff reguliert werden. Alle Teile komplett in silbergrauer Kunststofftasche.

No. 03161-02

World-famous otoscope/ophthalmoscope diagnostic set at a budget price for physicians and students. 2,5 V Standard illumination for use with 2 batteries type C. Set includes: **Otoscope head** - Pin contact fitting. Chrome-plated. Fixed protective lens in plastic mount may be removed for introduction of instruments. Plastic connector for pneumatic otoscopy. Removable swivel-mounted 4 x magnifier. 2, 3 and 4 mm reusable specula included. **May ophthalmoscope head**. Pin contact fitting. Lens selection wheel permits choice of corrective lenses from 0 to +20 and 0 to -20 diopters. Single large circle aperture. **Battery handle**. 28 mm \varnothing for 2 C-cell batteries. Chrome-plated. With thumb wheel for securing pin-contact heads. Rheostat for adjustment of illumination.

No. 03161-02

Este estuche de diagnóstico con iluminación standard 2,5 V es muy popular y muy económico, apropiado para estudiantes y médicos. Juego, compuesto de: **Cabeza otoscopio** cromado, con cierre de tornillo. Con cristal de cubierto en armadura plástica, con conector plástico para el test neumático. Con lente giratorio desmontable (amplificación: 4 veces más). **Cabeza oftalmoscopio May** con cierre de tornillo. Con ayuda de la rueda de lentes se puede elegir lentes de corrección de 0 a +20 y 0 a -20 dioptrías. Con una apertura: gran círculo. **Mango a pilas** cromado, 28 mm \varnothing para dos pilas tipo C. La intensidad de la luz es regulable con el reostato al tope del mango. Todos los partes se presentan en una bolsa plástica de color gris plata.

No. 03161-02

Combinazione per diagnostica otoscopio/oftalmoscopio a prezzo economico, per ambulatori e studenti. Illuminazione standard 2,5 V con 2 batterie tipo C. La combinazione comprende: **Testa otoscopio** - Chiusura a vite. Cromata. La lente di protezione fissa in supporto di plastica può essere tolta per l'inserimento di strumenti. Connettore di plastica per test pneumatico. Lente d'ingrandimento 4 x in montatura girevole estraibile. Inclusi specoli da 2, 3 e 4 mm riusabili. **Oftalmoscopio May**. Chiusura a vite. La rotella di selezione permette la scelta di lenti di correzione da 0 a +20 e da 0 a -20 diottrie. Apertura singola a cerchio grande. **Manico a pila** \varnothing 28 mm con 2 batterie tipo C. Cromato. Con ruota ad orlo zigrinato per fissare la testa dell'otoscopio con chiusura a vite. Reostato per la regolazione dell'illuminazione. Fornita in busta di plastica colore grigio argento.

Diagnostik-Bestecke mit Standardbeleuchtung
 Diagnostic Sets with Standard illumination
 Estuches de diagnóstico con iluminación standard
 Combinazioni per diagnostica con illuminazione standard



ECO "T" 03161-03T

- a) Otoskop, mit Schraubverschluss und 3 Ohrtrichtern, 2-3-4 mm
 Otoscope with screw fitting and 3 ear speculas with, 2-3-4 mm
 Otoscopio, con cierre a tornillo y con 3 espéculos auriculares de 2-3-4 mms
 Testa otoscopio: chiusura a vite, connettore di plastica per test pneumatico,
 3 specoli (2, 3 e 4 mm) riutilizzabili, lente di protezione da togliere
- b) Ophthalmoskop, 0 bis +20 und 0 bis -20 Dioptrien, mit Schraubverschluss
 Ophthalmoscope from 0 to +20 and 0 to -20 dioptres with screw fitting
 Oftalmoscopio, 0 a + 20 y 0 a - 20 dioptrías, con cierre a tornillo
 Testa oftalmoscopio: chiusura a vite, lenti di correzione da 0 a +20 e da 0 a -20 diottrie.
- c) Nasenspekulum
 Nasal Speculum
 Espéculo nasal
 Specoli nasali divaricabili
- d) Lampenträger mit Schraubverschluss
 Bent arm illuminator with screw fitting
 Porta-lámpara, con cierre a tornillo
 Porta lampada con 2 specchi laringei, misura 3 e 4.
- e) 2 Kehlkopfspiegel No. 3 und 4
 2 laryngeal mirrors no. 3 and 4
 Espejos laringeos Nos. 3 y 4
 Porta lampada con 2 specchi laringei, misura 3 e 4.
- f) Mundspatelhalter
 Tongue blade holder
 Abaja-lenguas
 Porta abbassa-lingua
- g) Batteriegriff für 2 Batterien mit Schraubverschluss (ohne Batterien)
 Battery handle for 2 batteries
 Mango para 2 pilas, con cierre a tornillo (sin pilas)
 Manico a pila (senza pila), illuminazione regolabile
- h) Ersatzlampchen 2.5 V
 Spare lamp 2.5 V
 Bombillo de repuesto 2.5 V
 Lampadina di ricambio

ECO "C" 03161-03C

Inhalt gleich wie oben, mit drehbarem Schnellverschluss.
 Contents same as above, but with quick plug-in connector.
 Mismo contenido como arriba pero con CIERRE RAPIDO GIRATORIO.
 Lo stesso contenuto come sopra ma con chiusura a baionetta.

Diagnostik-Bestecke mit Halogenbeleuchtung
 Diagnostic Sets with Halogen illumination
 Estuches de diagnóstico con iluminación halógena
 Combinazioni per diagnostica con illuminazione alogena



Kleine, sehr moderne Qualitätsinstrumente aus Kunststoff, grau, mit Halogenbeleuchtung 2,5 V. Sehr preiswert und aufgrund der Größe besonders gut für die Arzttasche geeignet. Schraubverschluss. **Otoskop:** Fiber-Optik. Anschluß für pneumatischen Test. Lupe vergrößert 2,5-fach. Batteriegriff für 2 Batterien Typ AA. **Ophthalmoskop:** Korrekturlinsen: 0 bis +20 und 0 bis -20 Dioptrien. Blenden: Kreis groß + klein, Halbkreis, Fixierstern und Grünfilter. Griff für 2 Batterien Typ AA. Das Otoskop- und das Otoskop/Ophthalmoskop-Besteck werden jeweils mit einem Metallkonnector für pneumatischen Test und Plastikröhrchen mit jeweils 5 wiederverwendbaren Ohrtrichtern 2,5 und 4,0 mm geliefert. Komplet in modernem schwarzen Kunststoffetui.

Nr. 03171-00 - Otoskop mit Griff AA.

Nr. 03171-01 - Ophthalmoskop mit Griff AA.

Nr. 03171-02 - Otoskop/Ophthalmoskop jeweils mit Griff AA.

Economically priced state-of-the-art quality instrument made of plastics, gray color, with halogen illumination 2,5 V. Due to its small size it is most suitable for each practitioner's bag. **Otoscope:** Fiber optic. Screw type fitting. 2,5 x magnifying glass. Battery handle for 2 AA-cell batteries. **Ophthalmoscope:** Corrective lenses ranging from 0 to +20 and 0 to -20 diopters. Apertures: large and small circle, semi-circle, fixation star and green filter. Otoscope and otoscope/ophthalmoscope set each contain a metal connector for pneumatic otoscopy as well as plastic tube with 5 each reusable ear specula 2,5 and 4,0 mm. All sets come in modern black plastic case.

No. 03171-00 - Ootoscope with AA-handle.

No. 03171-01 - Ophthalmoscope with AA-handle.

No. 03171-02 - Ootoscope/ophthalmoscope with 1 each AA-handle.

Instrumentos de calidad, muy moderno y pequeño de plástico resistente, gris, con iluminación halógena 2,5 V. Muy económico y gracias al tamaño apropiado para el bolsillo del médico. Cierre roscado. **Otoscopio:** fibra óptica. Conexión para test neumático. Lupa aumenta 2,5 veces más. Mango a pilas para 2 pilas, tipo AA. **Oftalmoscopio:** Lentes de corrección: 0 hasta +20 y o hasta -20 dioptrías. Aberturas: círculo grande y pequeño, semicírculo, estrella fijadora y filtro verde. Con mango para 2 pilas, tipo AA. Juego de otoscopio y de otoscopio/oftalmoscopio con conector metálico para el test neumático y con 5 espejuelos reutilizables de 2,5 y 4,0 mm en tubito de plástico. Todos los juegos se presentan en estuche de plástico negro moderno.

No. 03171-00 - Otoscopio con mango AA.

No. 03171-01 - Oftalmoscopio con mango AA.

No. 03171-02 - Oto/oftalmoscopio con mangos AA.

Strumento piccolo, moderno, di alta qualità realizzato in plastica, grigio, con illuminazione alogena 2,5 V. Molto economico e, date le sue dimensioni, il più adatto a stare nella borsa del medico. **Otoscopio:** con attacco a vite. Lente d'ingrandimento 2,5X. Manico a pila per 2 batterie tipo AA. **Oftalmoscopio:** Lenti correttive da 0 a +20 e da 0 a -20 diottrie. Aperture: a cerchio grande e piccolo, semicerchio, a stella, filtro verde. Con manico per 2 batterie tipo AA. L'otoscopio e la combinazione otoscopio/oftalmoscopio hanno un connettore per test pneumatico e tubo di plastica con 5 specoli auricolari 2,5 e 4,0 mm. cad. Tutte le combinazioni sono fornite in un moderno astuccio di plastica nera.

No. 03171-00 - Otoscopio con manico AA.

No. 03171-01 - Oftalmoscopio con manico AA.

No. 03171-02 - Oto/Oftalmoscopio con manici AA.



Nystagmusbrille
 Nystagmus spectacles
 Anteojos para nistagmo
 Occhiali nistagmo



FRENZEL

03167-03
 Beleuchtete Nystagmusbrille
 mit querliegendem
 Batteriehandgriff und festen
 Gläsern

Energiequelle:
 2 Stück 4-Volt-Lämpchen
 2 Stück Baby-Zellen 1.5 V

03167-03
 Anteojos para nistagmo, con
 iluminación, con mango para
 pilas en forma horizontal,
 vidrios fijos,

Alimentación:
 2 unidades de bombillos de
 4 voltios
 2 unidades de pilas de
 1.5 voltios

03167-03
 Nystagmus spectacles for
 observation of the eyes during
 examination of the vestibular
 apparatus, with battery handle
 and fixed glasses. Illuminated
 on inside of lenses.

Source of energy:
 2 bulbs 4-volt
 2 baby-battery cells 1.5 V

03167-03
 Occhiali Nistagmo illuminati
 con manipoło a batteria,
 lenti fisse.
 Per la rilevazione della reazione
 patologica del nistagmo.

Alimentazione:
 2 lampadine 4 Volt
 2 batterie 1,5 Volt

Stirnlampen
Head Lights
Lámparas frontales
Lampade frontali



03180-94



03180-93

 ZIEGLER
03180-90
compl.

03180-92

03180-90
Ziegler-Stirnspiegel,
komplett, mit schwarzem
Stirnreifen,
mit Kugelgelenk,
90 mm ø

03180-90
Ziegler Head Mirror,
complete with black head
band, with ball socket,
90 mm ø

03180-90
Ziegler espejo frontal, com-
pleto con cinta negra,
con articulación,
90 mm ø

03180-90
Specchio frontale, Ziegler,
completo con fascia nera,
con snodo sferico,
90 mm di ø

03180-92
Stirnreifen, allein

03180-92
head band, only

03180-92
cinta, suelta

03180-92
fascia, sola

03180-93
Spiegel, allein
90 mm ø

03180-93
Mirror, only
90 mm ø

03180-93
Espejo, suelto
90 mm ø

03180-93
Specchio,
solo 90 mm ø

03180-94
Gelenk für Stirnreifen

03180-94
Socket joint for head bands
only

03180-94
Articulación para cintas fron-
tales suelta

03180-94
Snodo sferico per fascie
frontali

Stirnlampen
Head Lights
Lámparas frontales
Lampade frontali



03195-00
CLAR

komplett mit Stirnstreifen und Kabel
complete with head band and cable
completo con cinta frontal y cable
completa con fascia frontale e cordone



03195-01

Spiegel aus Glas ohne Fassung
Glass Mirror without frame
Reflector de cristal, sin montura
Riflettore di cristallo, senza montatura



03195-06
6 Volt



03195-07 Kleintransformator
220 Volt = 0 - 10 Volt / 3 Watt
Mini-Transformer Unit
Transformador eléctrico pequeño
Mini-trasformatore elettrico

03195-08 Kleintransformator
110 Volt = 0 - 10 Volt / 3 Watt
Mini-Transformer Unit
Transformador eléctrico pequeño
Mini-trasformatore elettrico

03195-09 Clar-Spiegel-Gelenkverbindung
Clar special socket joint
Articulación especial de Clar
Snodo speciale di Clar

03195-04 Stirnstreifen, alleine
head band, only
cinta frontal, suelta
fascia frontale, sola

03195-10 Clar Kopfsprange allein aus Metall
mit Kabelaschen und
Fixierschraube mit Gelenk
Clar spring metal head band only,
with cable clips and fixing screw
with socket joint
Casco frontal de resorte metálico
suelto de Clar, con bridas de
cable, y tornillo de sujeción con
articulación
Fascia metallica a casco di Clar,
solo, con portacordoni e vite di
fissaggio a snodo

Stethoskope
Stethoscopes
Estetoscopios
Stetoscopi

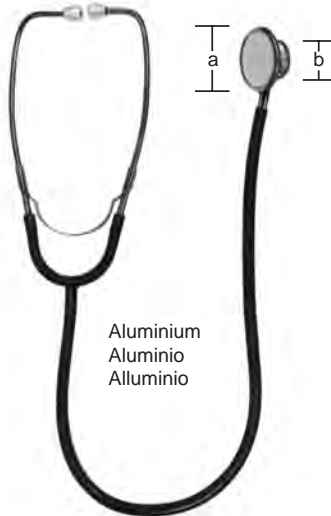

Aluminium
Aluminio
Alluminio

DUPLEX

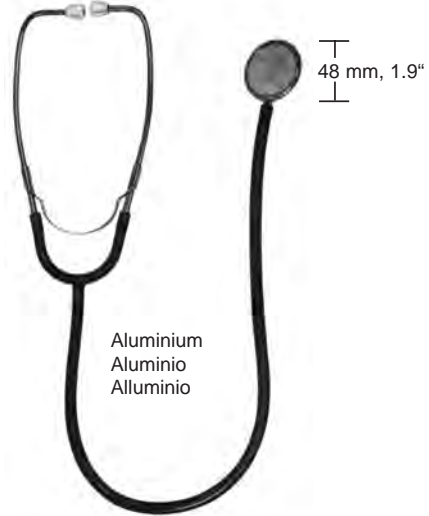

Aluminium
Aluminio
Alluminio

ANESTOPHON
03248-00

	a	b	
03246-00	48 mm, 1.9"	30 mm, 1.2"	
03246-01	39 mm, 1.5"	25 mm, 1.0"	Baby
03246-02	21 mm, 0.8"	21 mm, 0.8"	Neonatal



PINARD
03260-15 15 cm, 6"
ALU



PINARD
03262-18 18 cm, 7"

Holz, wood,
madera, legno

Perkussionshämmer
Percussion Hammers
Martillos de percusión
Martelli da percussione



TAYLOR - USA Mod.
03288-17 17 cm, 6 3/4"
03288-20 20 cm, 8"



BABINSKY
03292-22 22 cm, 8 3/4"



TROEMNER
03294-24 24 cm, 9 1/2"



DEJERINE
03304-20 20 cm, 8"



BERLINER
03306-17 17 cm, 6 3/4"



BUCK
03308-18 18 cm, 7"

Prüf- und Meßinstrumente
 Examination and Measuring Instruments
 Instrumentos para exámenes y medidas
 Strumenti per esaminare e misurare

Dynamometer
 Dynamometer
 Dinamómetro
 Dinamometro



COLLIN
 03310-01 Erwachsene, Adult,
 adultos, adulti
 03310-02 Kind, child, niños, bambini

Winkelmesser
 Goniometer
 Goniómetro
 Goniometro



MOELTGEN
 03312-01



Finger-Goniometer
 Finger goniometer
 Goniómetro para dedos
 Goniometro per le dita
 03314-01



WARTENBERG
 03320-19 19 cm, 7 1/2"



aus Stahl
 of steel
 de acero
 di acciaio
 03350-15 1,5 m 0.6"

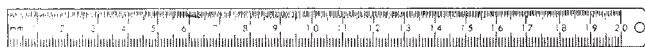

Metall		
03340-10	10 cm	4"
03340-15	15 cm	6"
03340-20	20 cm	8"
03340-30	30 cm	12"
03340-50	50 cm	20"

Schieblehren
Calipers
Calibres
Calibro

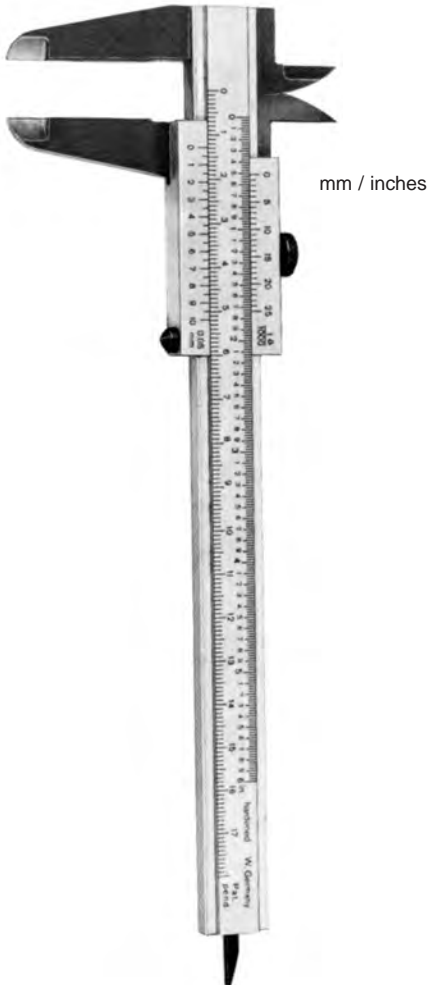

03360-21
21 cm, 8 1/4"

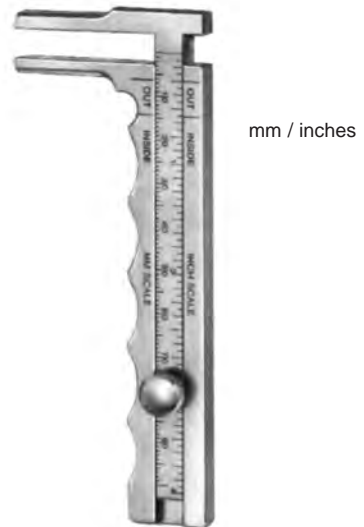

TOWNLEY
03361-10
11,5 cm, 4 1/2"

Saugrohre
Suction tubes
Tubos de aspiración
Cannule per aspirazione



POOLE 20 cm, 8"
05130-05 5.5 mm ø, 0.2"
(17 Fr.)

05130-10 10 mm ø, 0.4"
(30 Fr.)



POOLE 19 cm, 7 1/2"
05140-05 5.5 mm ø, 0.2"
(17 Fr.)

05140-08 8 mm ø, 0.3"
(23 Fr.)



compl. BABY-YANKAUER
05150-21 21 cm, 8 1/4"

compl. YANKAUER
05150-27 27 cm, 10 1/2"

Saugrohre
Suction tubes
Tubos de aspiración
Cannule per aspirazione

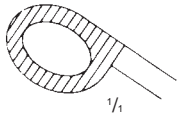

05190-25
25 cm, 10"

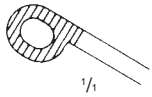

05190-20
20 cm, 8"



05190-17
17 cm, 6 3/4"

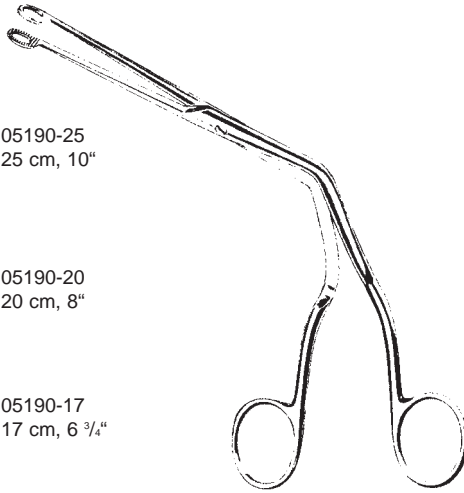

MAGILL



ANDREW-PYNCHON

05170-24
6 mm \varnothing , 1/2"
24 cm
9 1/2"

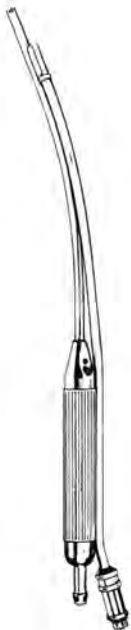

COOLEY
05160-01
8 mm \varnothing , 0.3" / 36 cm, 14 1/4"
mit Kaltlicht
with cold-light
con luz fria
con luce fredda



COOLEY
05160-02
8 mm \varnothing , 0.3"
36 cm
14 1/4"



COOLEY
05160-03
8 mm \varnothing , 0.3"
30 cm
11 3/4"



DE BAKEY
05160-04
3 mm \varnothing , 0.1"
27 cm
10 1/2"

Laryngoskope
Laryngoscopes
Laringoscopios
Laringoscopi



McINTOSH

Fig. 0	5,5 cm	2 1/4"	05210-00
Fig. 1	7,5 cm	3"	05210-01
Fig. 2	9,0 cm	3 1/2"	05210-02
Fig. 3	11,0 cm	4 3/8"	05210-03
Fig. 4	13,5 cm	5 1/4"	05210-04

Cold light
05211-00
05211-01
05211-02
05211-03
05211-04



05239-03
Halogen-Lampe
Halogen Lamp
Lámpara Halógena
Lampada Alogena



05239-01
f./p. Fig. 0-1



05239-02
f./p. Fig. 2-4



FOREGGER

Fig. 0	5,5 cm	2 1/4"	05220-00
Fig. 1	7,0 cm	2 3/4"	05220-01
Fig. 2	9,0 cm	3 1/2"	05220-02
Fig. 3	11,0 cm	4 3/8"	05220-03
Fig. 4	13,5 cm	5 1/4"	05220-04

Cold light
05221-00
05221-01
05221-02
05221-03
05221-04



05239-03
Halogen-Lampe
Halogen Lamp
Lámpara Halógena
Lampada Alogena



05239-01
f./p. Fig. 0-1



05239-02
f./p. Fig. 2-4

Laryngoskope
Laryngoscopes
Laringoscopios
Laringoscopi

MILLER



05230-00
55 mm, 2.1/2"
Nutzlänge
working length
largo útil
lunghezza utile

für Säuglinge
for babies
para neonatales
per neonati



05230-01
80 mm, 3 1/8"
Nutzlänge
working length
largo útil
lunghezza utile

für Kinder
for children
para niños
per bambini



05230-02
130 mm, 5"
Nutzlänge
working length
largo útil
lunghezza utile

für Jugendliche
for adolescents
para adolescentes
per adolescenti



05230-03
170 mm, 6 3/4"
Nutzlänge
working length
largo útil
lunghezza utile

für Frauen
for women
para mujeres
per donne



05230-04
180 mm, 7"
Nutzlänge
working length
largo útil
lunghezza utile

für Männer
for men
para hombres
per uomini



05239-01
f./p. Fig. 0-1



05239-02
f./p. Fig. 2-4

Laryngoskope
Laryngoscopes
Laringoscopios
Laringoscopi



McIntosh

05203-00

Set bestehend aus:
1 Etui
1 Batteriegriff 05234-28
3 Spatel (Fg. 2-4)

Set consisting of:
1 Case
1 Handle
3 Blades (Fg. 2-4)

Juego compuesto de:
1 Estuche
1 Mango
3 Hoja (Fg. 2-4)

Set composto da:
1 Astuccio
1 Manico
3 Spatole (Fg. 2-4)

05204-00

Set bestehend aus:
1 Etui
1 Batteriegriff 05234-28
4 Spatel (Fg. 1-4)

Set consisting of:
1 Case
1 Handle
4 Blades (Fg. 1-4)

Juego compuesto de:
1 Estuche
1 Mango
4 Hoja (Fg. 1-4)

Set composto da:
1 Astuccio
1 Manico
4 Spatole (Fg. 1-4)



Foregger

05223-00

Set bestehend aus:
1 Etui
1 Batteriegriff 05234-28
3 Spatel (Fg. 2-4)

Set consisting of:
1 Case
1 Handle
3 Blades (Fg. 2-4)

Juego compuesto de:
1 Estuche
1 Mango
3 Hoja (Fg. 2-4)

Set composto da:
1 Astuccio
1 Manico
3 Spatole (Fg. 2-4)

05224-00

Set bestehend aus:
1 Etui
1 Batteriegriff 05234-28
4 Spatel (Fg. 1-4)

Set consisting of:
1 Case
1 Handle
4 Blades (Fg. 1-4)

Juego compuesto de:
1 Estuche
1 Mango
4 Hoja (Fg. 1-4)

Set composto da:
1 Astuccio
1 Manico
4 Spatole (Fg. 1-4)

Batteriegriffe, Warmlicht
Battery handles, warm light
Mango de pila, luz caliente
Manico a batteria, luce calda



05233-18 18 mm ø, 3/4"



05234-28 28 mm ø, 1"
05234-37 37 mm ø, 1 1/2"



05238-01 30 mm ø, 1 1/4"

Batteriegriffe, Kaltlicht
Battery handles, cold light
Mango de pila, luz fria
Manico a batteria per luce fredda



05238-02
18 mm \varnothing
 $\frac{3}{4}$ "



05238-03
30 mm \varnothing
1 $\frac{1}{4}$ "

Batteriegriffe, Warmlicht
 Battery handles, warm light
 Mango de pila, luz caliente
 Manico a batteria, luce calda



05240-30 30 mm \varnothing , 1 1/4"
 Griff mit Trafo-Anschluß
 Handle with Transformer-connection
 Mango con conexión al transformador
 Manico con connessione al trasformatore



05241-11 Trafo 110 V
 05241-22 Trafo 220 V

Trafo 110 Volt mit amerikanischem Netzanschluß
 Transformador 110 Volt with american mains connection
 Transformador 110 V con conexión americana
 Trasformatore 110 V ricarica batteria

Trafo 220 Volt mit 1,40 m (55") langem Kabel
 Transformador 220 Volt with cable 1,40 m (55") long
 Transformador, 220 V con cable de 1,40 m (55")
 Trasformatore 220 V ricarica batteria

Laryngoskope
Laryngoscopes
Laringoscopios
Laringoscopi

Operation Laryngoskop:
rostfreier Edelstahl
Rohr: innen matt/außen glänzend
Griff: ganz matt

Operation Laryngoscope:
stainless steel
tube: inner surface matt/outer
surface polished
handle: matt

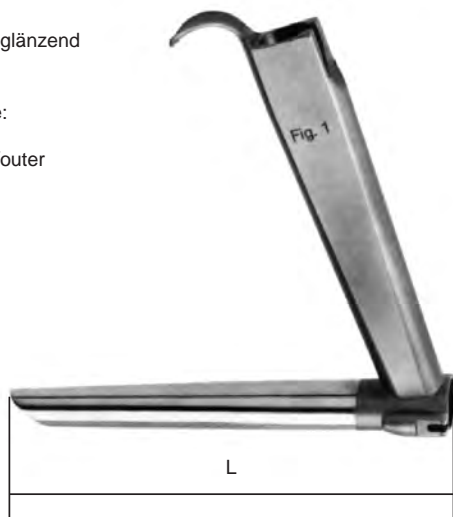

Laringoscopio para operaciones:
Acero inoxidable
Pala: Superficie interior: Mate
Superficie exterior: Brillante
Mango entero: Mate

Laringoscopio a luce
fredda per microchirurgia
endolaringeo
tubo: interiore opaco – esterno lucido
manico: opaco

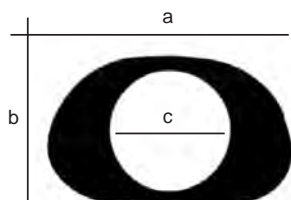

Nr.	L (mm)	a (mm)	b (mm)	c (mm)
05301-01	135	21,8	14,0	13,0
05301-02	152	22,5	14,8	13,0
05301-03	182	23,0	15,0	14,0
05301-04	172	29,5	18,0	17,0
05301-05	172	31,5	21,5	19,0

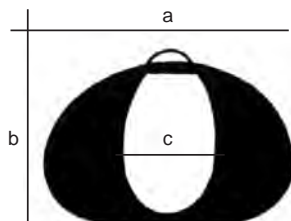

Nr.	L (mm)	a (mm)	b (mm)	c (mm)
05301-06	182	29,0	20,0	16,0 x 26,0
05301-07	222	29,0	20,0	16,0 x 26,0

Laryngoskope
Laryngoscopes
Laringoscopios
Laringoscopi

05300-01/02 Bruststütze für Erwachsene/Kinder bestehend aus:
05300-03 Stützstange für Erwachsene 34 cm / 05300-06 Ring / 05300-05 Gelenk
05300-04 Stützstange für Kinder 24 cm / 05300-06 Ring / 05300-05 Gelenk
05300-01/02 Chest Support for adults/children complete consisting of:
05300-03 Support rod for adults 34 cm / 05300-06 Ring / 05300-05 Joint
05300-04 Support rod for children 24 cm / 05300-06 Ring / 05300-05 Joint
05300-01/02 Soporte pectoral para adultos/niños compuesto de:
05300-03 para adultos 34 cm / 05300-06 / 05300-05
05300-04 para niños 24 cm / 05300-06 / 05300-05
05300-01/02 Braccio portalarinoscopio sternale per adulti/bambini composto da:
05300-03 per adulti 34 cm / 05300-06 anello / 05300-05 giunto
05300-04 per bambini 24 cm / 05300-06 anello / 05300-05 giunto

Operationslaryngoskop, Kleinsasser
Operation laryngoscope, Kleinsasser
Laringoscopios operativo, Kleinsasser
Laringoscopio operativo, Kleinsasser

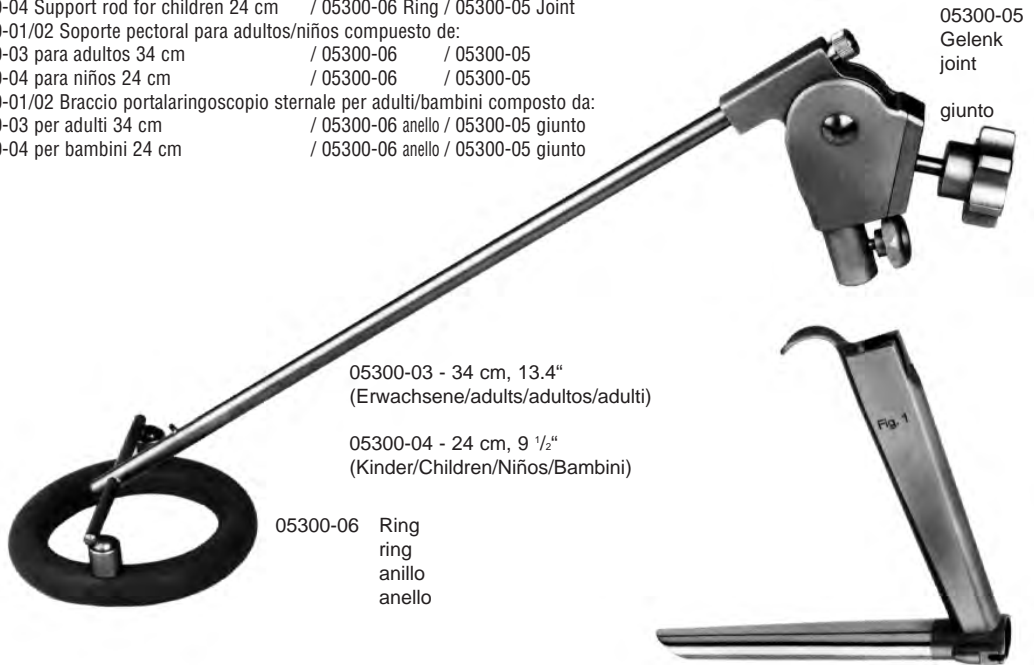

05300-03 - 34 cm, 13.4"
(Erwachsene/adults/adultos/adulti)

05300-04 - 24 cm, 9 1/2"
(Kinder/Children/Niños/Bambini)

05300-06 Ring
ring
anillo
anello

05300-05
Gelenk
joint

giunto

Fiberglas-Lichtträger – Fiberglas-light-guide –
Portadore de luz fria – portatore di luce fredda
a fibre di vetro

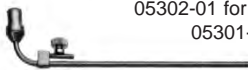

05302-01 for Laryngoskope
05301-01 - 05301-02

05303-01
Injektionskanüle für Laryngoskope: 05301-01 - 05301-07
Injetion drain tube for Laryngoscopes: 05301-01 - 05301-07
Canúla de inyeccion para laringoscopios: 05301-01 - 05301-07
Cannula da iniezione per laringoscopi: 05301-01 - 05301-07

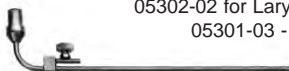

05302-02 for Laryngoskope
05301-03 - 05301-06

05304-01
Rauchabsaugrohr für Laryngoskop:
Suction tube for Laryngoscopes: 05301-03 - 05301-07
Canúla de succion para laringoscopios: 05301-03 - 05301-07
Tubo di aspirazione per laringoscopi: 05301-03 - 05301-07

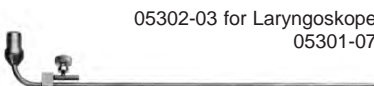

05302-03 for Laryngoskope
05301-07



Laryngoskope
Laryngoscopes
Laringoscopios
Laringoscopi

HOLINGER Laryngoskop
HOLINGER Laryngoscope
HOLINGER Laringoscopio
HOLINGER Laringoscopi

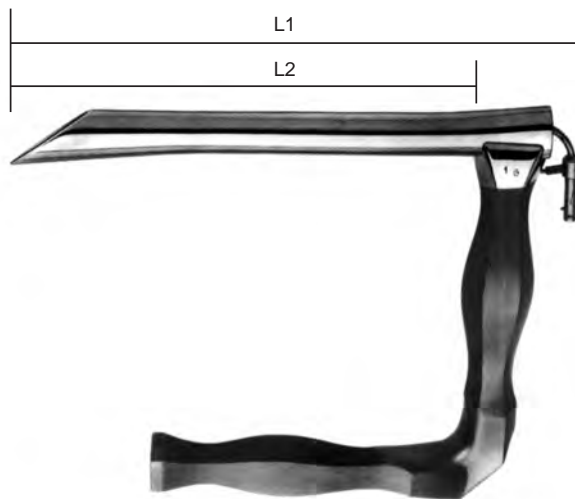

Nr.	L1	L2	Lichtträger light guide Portador de luz portatore di luce
05310-01	180 mm	157 mm	05311-01
05310-02	170 mm	146 mm	05311-02
05310-03	120 mm	98 mm	05311-03
05310-04	90 mm	77 mm	05311-04

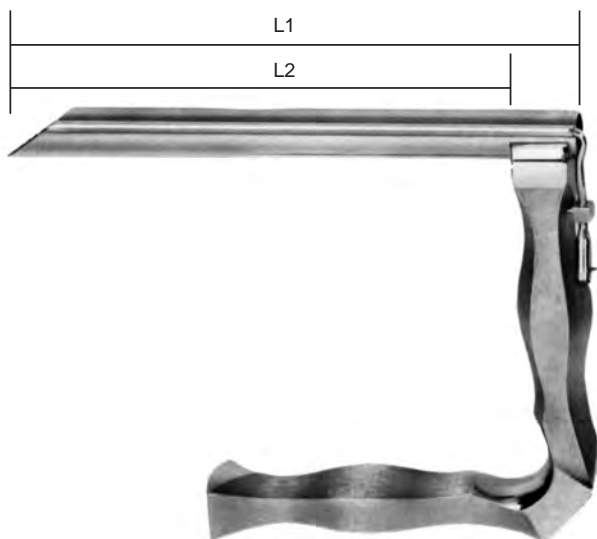

JACKSON Laryngoskop
JACKSON Laryngoscope
JACKSON Laringoscopio
JACKSON Laringoscopi

Nr.	L1	L2	Außen-Dm Outer-dm dm-exterior dm-esterno	Innen-Dm Inner-dm dm-interior dm-interno	Lichtträger light guide Portador de luz portatore di luce
05320-01	160 mm	135 mm	17,5 mm	14,5 mm	05321-01
05320-02	160 mm	135 mm	14,5 mm	12,0 mm	05321-02
05320-03	120 mm	105 mm	14,0 mm	11,5 mm	05321-03
05320-04	90 mm	75 mm	13,0 mm	10,0 mm	05321-04

Skalpelli-Griffe
 Scalpel Handles
 Mangos de bisturíes
 Manici per lama bisturi

passend zu den Klängen
 for blades
 para las hojas
 per lama bisturi

(A) No. 10, 11, 12, 13, 14, 15, 16, 17, 18, 19

(B) No. 20, 21, 22, 23, 24, 25



07103-00

Fig. 3

(A)



07103-01

Fig. 3 grad.

(A)



07103-02

Fig. 3 L

(A)

Skalpell-Griffe
Scalpel Handles
Mangos de bisturíes
Manici per lama bisturi



07104-00
Fig. 4
ⓑ



07104-02
Fig. 4 L
ⓑ



07105-02
Fig. 4 L
ⓑ

Skalpelli-Griffe
Scalpel Handles
Mangos de bisturíes
Manici per lama bisturi



07106-01
14,5 cm 5 3/4"

(A)



07106-02
14 cm 5 1/2"

(A)

Skalpelli-Griffe
Scalpel Handles
Mangos de bisturíes
Manici per lama bisturi



07107-00
Fig. 7

(A)



07107-01
Fig. 7K

(A)



07107-03

(A)



07107-04

(A)

Skalpelli-Griffe
Scalpel Handles
Mangos de bisturíes
Manici per lama bisturi



07108-00
Fig. 8

(B)



07109-03
Fig. 3 L

(A)

Skalpelli-Griffe
Scalpel Handles
Mangos de bisturíes
Manici per lama bisturi



07161-00 07162-00 07165-00 07167-00

Packung mit 10 Stück
box of 10
en cajas de 10 pzas
confezione di 10

07109-10 10,0 cm, 4"
07109-13 13,0 cm, 5"
07109-15 15,5 cm, 6"

Skalpelli-Klingen, Steril
 Scalpel Blades, Sterile
 Hojas de bisturí, estéril
 Lame per bisturi, sterili

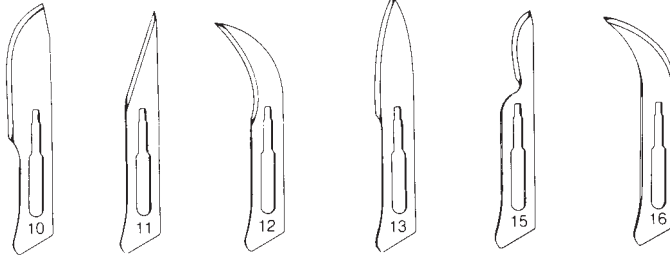

07110-00 07111-00 07112-00 07113-00 07115-00 07116-00

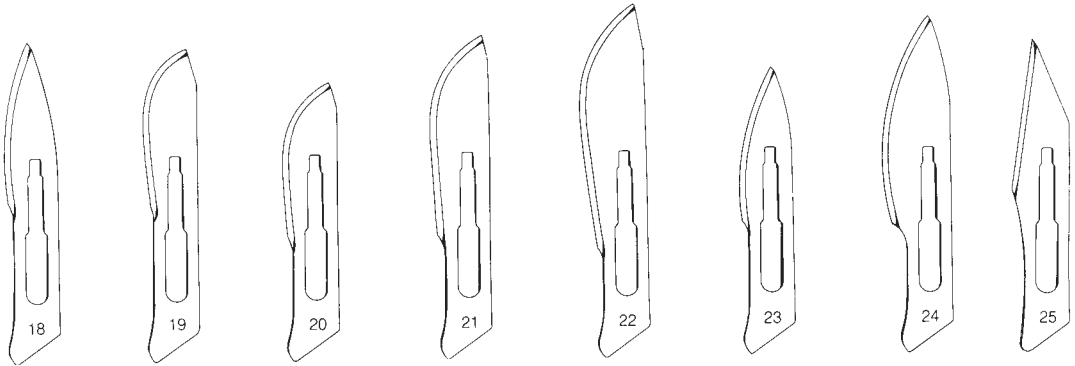

07118-00 07119-00 07120-00 07121-00 07122-00 07123-00 07124-00 07125-00



Packung mit 100 Stück
 in packages of 100 each
 en cajas de 100 c/u
 confezione di 100 pezzi

Skalpelli-Klingen-Entferner
 Scalpel Blade Remover
 Quita hojas
 Togliilama



07130-00

Einmal-Skalpelle, Steril
Disposable Scalpels, Sterile
Bisturíes uso único, estériles
Bisturi monouso, sterili



07210-00

Packung mit 10 Stück
in packages of 10 each
en cajas de 10 c/u
confezione di 10 pezzi



07211-00



07212-00



07213-00



07215-00



07218-00



07219-00



07220-00



07222-00



07224-00



07225-00

Amputationsmesser
Amputation Knives
Cuchillos para amputaciòn
Coltelli per amputazione

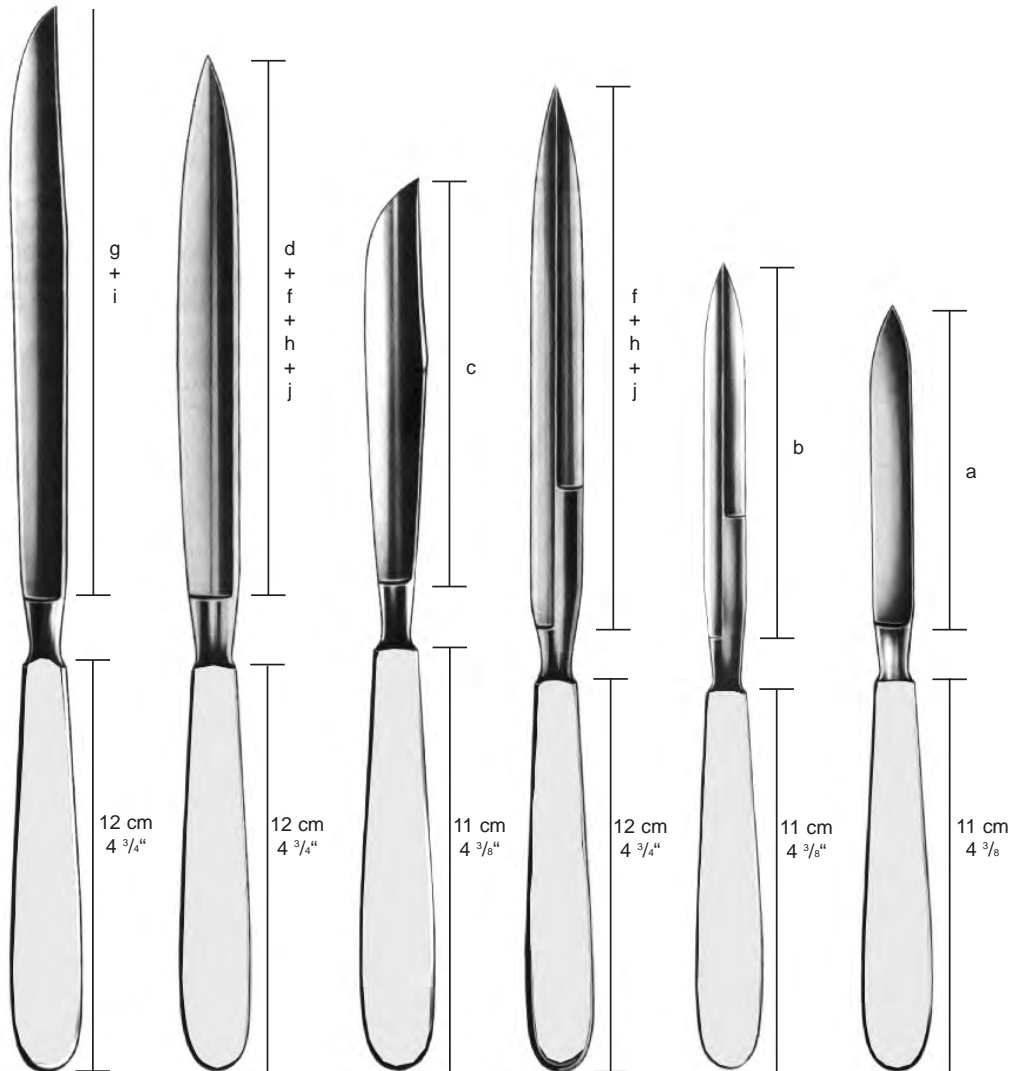

Liston
07200-17
07200-20

Reda
07201-13
07201-16
07201-19
07201-22

Langenbeck
07202-12

Catlin
doppelschneidig
double
aftingedeges
filo doble
doppio taglio
07203-16
07203-19
07203-22

07204-11

Zwischenknochen-
messer doppel-
schneidig
Inerosseous knife
double aftingedeges
Cuchillo interóseo
filo doble
Coltello interosseo
doppio taglio

07205-09

Phalangen-
messer
Phalangeal knife
Cuchillos para
falanges
Coltello per falangi

Schnittlänge
Length of blades
Largo de hojas
Lunhezze delle lame

a - 9,5 cm	c - 12,0 cm	e - 15,0 cm	g - 17,0 cm	i - 20,0 cm
b - 11,0 cm	d - 13,0 cm	f - 16,0 cm	h - 19,0 cm	j - 22,0 cm
a - 3 3/4"	c - 4 3/4"	e - 6"	g - 6 3/4"	i - 8"
b - 4 3/8"	d - 5"	f - 6 1/4"	h - 7 1/2"	j - 8 3/4"

Klingenbrecher, Rasierklingen
Blade Breakers, Razor Blades
Rompe-hojas, hojas de afeitar
Lama di rasoio, Rompilamette



TROUTMAN-CHRIS
07290-09 9 cm, 3 1/2"



REDA
07291-11 11 cm, 4 3/8"



CASTROVIEJO
07294-13 13 cm, 5 1/8"



07296-00

Packung = 10 Stück
package = 10 each
caja = 10 c/u
confezione = 10 pezzi

Skalpelle mit Metallheft
 Scalpels with Metal Handle
 Bisturíes, mango metálico
 Bisturi, manico di metallo



Fig. 1
 07402-01
 15 cm, 6"
 30 mm, 1.2"

Fig. 2
 07402-02
 15 cm, 6"
 36 mm, 1.4"

Fig. 3
 07402-03
 15,5 cm, 6"
 40 mm, 1 1/2"

Fig. 4
 07402-04
 16 cm, 6 1/4"
 45 mm, 1 3/4"

Fig. 5
 07402-05
 16 cm, 6 1/4"
 50 mm, 2"



Fig. 6
 07402-06
 15 cm, 6"
 27 mm, 1"

Fig. 7
 07402-07
 15 cm, 6"
 35 mm, 1.4"

Fig. 8
 07402-08
 16 cm, 6 1/4"
 40 mm, 1 1/2"

Fig. 9
 07402-09
 16 cm, 6 1/4"
 47 mm, 1.9"

Fig. 10
 07402-10
 17 cm, 6 3/4"
 50 mm, 2"

Resektions- und Knorpelmesser
 Resection and Cartilage Knives
 Cuchillos para resección/cartilagos
 Coltelli per resezione e cartilagini



6,5 cm
2.6"

Beinhautmesser
 mit Schaber
 Periosteum Knife
 with raspatory
 Cuchillo para
 periostio, con
 periostótamo
 Coltello per
 periostio con
 raschino

19 cm, 7 1/2"

07403-01

Metallheft
 metal handle
 mango metálico
 manico di metallo



6,5 cm
2.6"

19 cm, 7 1/2"

07403-02

Holzheft
 wooden handle
 mango de madera
 manico in legno



5,5 cm
2.2"

07412-05

18 cm, 7"

07410-05
 Langenbeck

Sezier-, Hirn- und Organmesser
Autopsy- Brain- and Post mortem knives
Cuchillos para autopsia- cerebro- órganos
Coltelli per cartilagini- cervello e organi

Schnittlänge
Length of blades
Largo de hojas
Lunghezze delle lame

- a - 8,5 cm, 3,4"
- b - 9,5 cm, 3 3/4"
- c - 11,0 cm, 4 3/8"
- d - 14,0 cm, 5 1/2"
- e - 16,0 cm, 6 1/4"
- f - 17,0 cm, 6 3/4"
- g - 19,5 cm, 7 3/4"
- h - 20,0 cm, 8"
- i - 24,0 cm, 9 1/2"

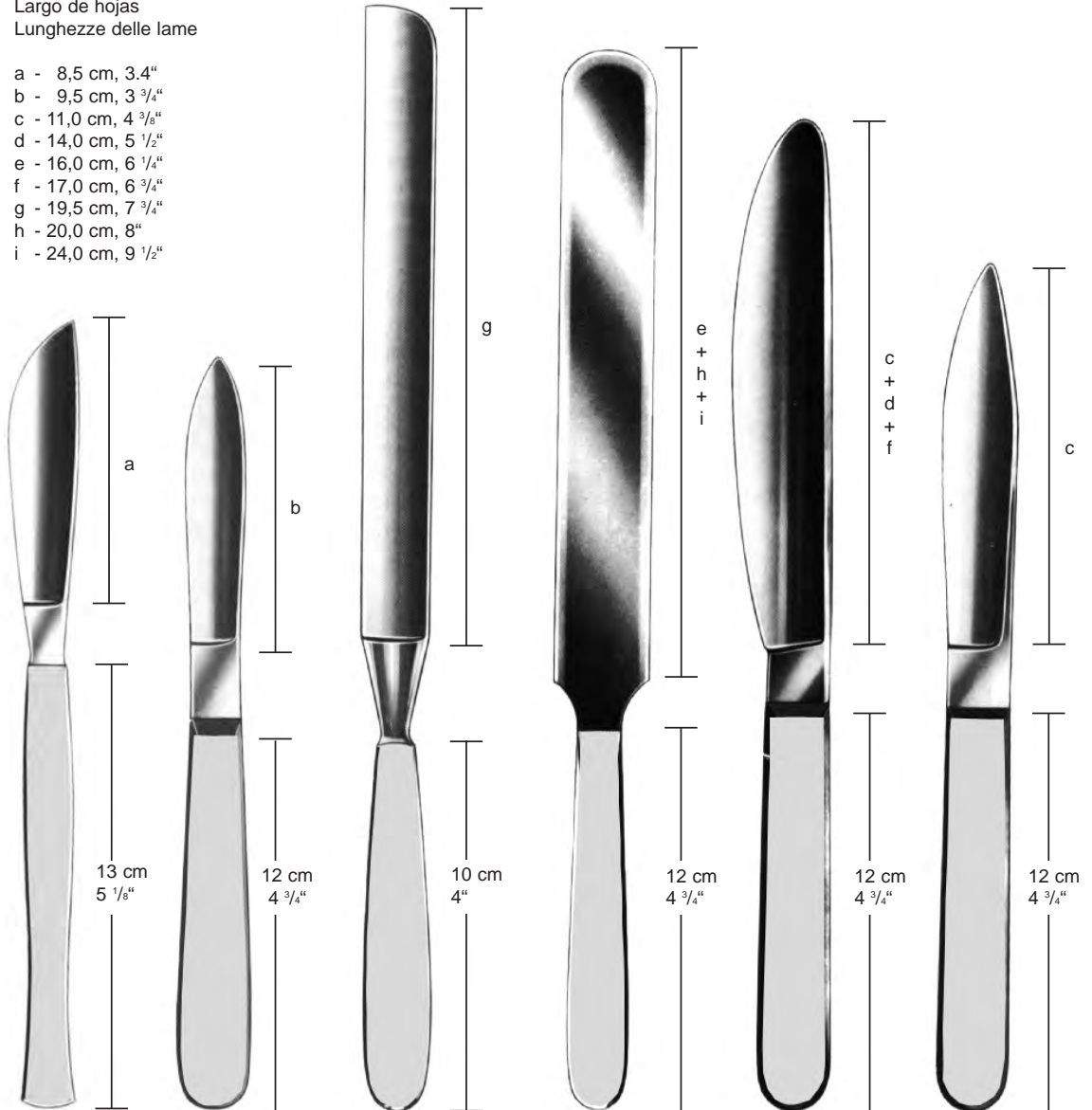

Virchow
07420-08

Virchow
07421-09

07422-19

Virchow
07423-16
07423-20
07423-24

07424-11
07424-14
07424-17

07425-11

Dermatome, Rasiermesser
 Dermatome, Razor
 Dermátomo, Navajas
 Dermatomo, Rasoio



SCHINK
 07490-00
 30 cm, 11 3/4"
 0,1 - 2 mm
 compl.
 mit/with/con

07490-01 (1) Stk./ pcs/ pzas
 07490-02 (2) Stk./ pcs/ pzas



07490-01
 Ersatzklinge
 Spare blade
 Hoja de repuesto
 Lama di ricambio per dermatomo

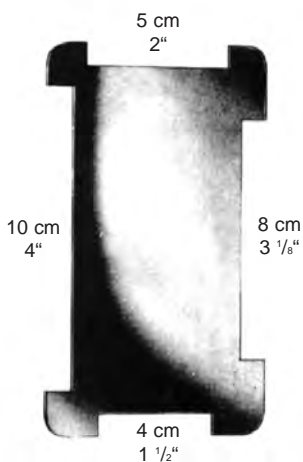

07490-02
 Spannplatte
 Skin straightening plate
 Placa para extender la piel
 Placca per stendipelle



07496-00
 Rasiermesser 8 cm, 3 1/8"
 Razors 8 cm, 3 1/8"
 Navajas 8 cm, 3 1/8"
 Rasoio 8 cm, 3 1/8"

Dermatome
 Dermatome
 Dermátomo
 Dermatomo

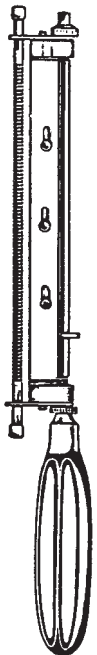

07496-31

Ersatzklingen
 Spare blades pack
 Hoja de repuesto
 Lama di ricambio

HUMBY
 07495-31 31 cm, 12 1/4"
 0,1 - 1,2 mm



SILVER
 07498-00
 190 mm, 7 1/2"
 Dermatome, ohne Klinge
 Skin graft knife, without blade
 Dermátomo sin hoja
 Senza lama utilizzo con lamette
 da barba normale



Klingen
 blades
 bisturi
 07499-01

WATSON
 07499-00
 300 mm, 11 3/4"
 Dermatome, ohne Klinge
 Skin graft knife, without blade
 Dermátomo sin hoja
 Senza lama utilizzo con lamette
 da barba normale

Chirurgische Scheren
 Operating Scissors
 Tijeras para cirugía
 Forbici per chirurgia



STANDARD

09102-11 11,5 cm, 4 1/2"
 09102-13 13,0 cm, 5"
 09102-14 14,5 cm, 5 3/4"
09104-14 TC
 09102-15 15,5 cm, 6"
 09102-16 16,5 cm, 6 1/2"
 09102-18 18,5 cm, 7 1/4"
 09102-20 20,0 cm, 8"



STANDARD

09110-11 11,5 cm, 4 1/2"
 09110-13 13,0 cm, 5"
 09110-14 14,5 cm, 5 3/4"
09114-14 TC
 09110-15 15,5 cm, 6"
 09110-16 16,5 cm, 6 1/2"
 09110-18 18,5 cm, 7 1/4"
 09110-20 20,0 cm, 8"



STANDARD

09120-11 11,5 cm, 4 1/2"
 09120-13 13,0 cm, 5"
 09120-14 14,5 cm, 5 3/4"
09124-14 TC
 09120-15 15,5 cm, 6"
 09120-16 16,5 cm, 6 1/2"
 09120-18 18,5 cm, 7 1/4"
 09120-20 20,0 cm, 8"



STANDARD

09103-11 11,5 cm, 4 1/2"
 09103-13 13,0 cm, 5"
 09103-14 14,5 cm, 5 3/4"
09105-14 TC
 09103-15 15,5 cm, 6"
 09103-16 16,5 cm, 6 1/2"
 09103-18 18,5 cm, 7 1/4"
 09103-20 20,0 cm, 8"



STANDARD

09111-11 11,5 cm, 4 1/2"
 09111-13 13,0 cm, 5"
 09111-14 14,5 cm, 5 3/4"
09115-14 TC
 09111-15 15,5 cm, 6"
 09111-16 16,5 cm, 6 1/2"
 09111-18 18,5 cm, 7 1/4"
 09111-20 20,0 cm, 8"



STANDARD

09121-11 11,5 cm, 4 1/2"
 09121-13 13,0 cm, 5"
 09121-14 14,5 cm, 5 3/4"
09125-14 TC
 09121-15 15,5 cm, 6"
 09121-16 16,5 cm, 6 1/2"
 09121-18 18,5 cm, 7 1/4"
 09121-20 20,0 cm, 8"

Präparierscheren
Dissecting Scissors
Tijeras de disección
Forbici per dissezione

Inzisionsschere – Incision Scissors – Tijera de incision – Forbici per incisione

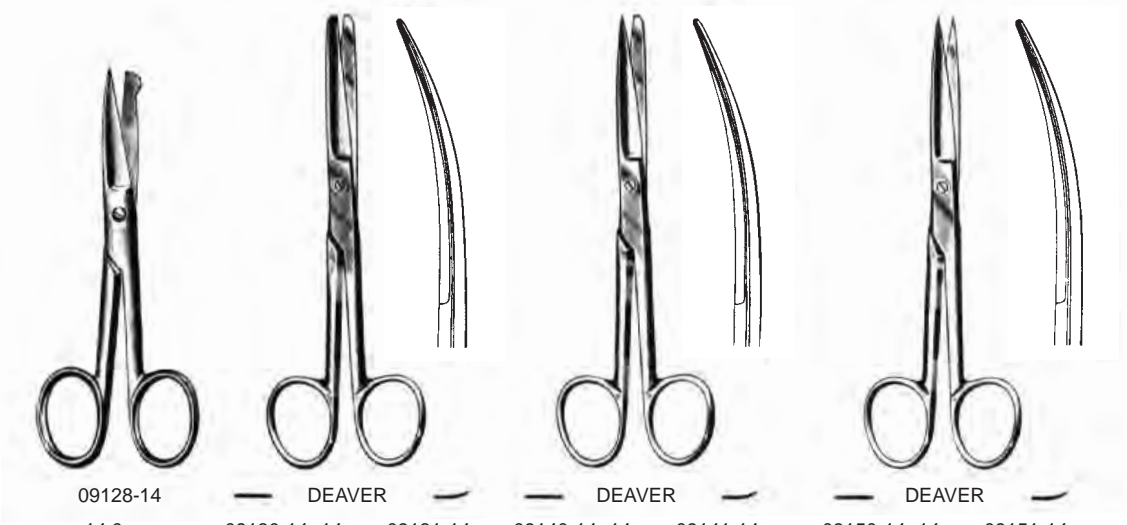

09128-14

14,0 cm
5 1/2"

DEAVER

09130-14 14 cm 09131-14
5 1/2"

DEAVER

09140-14 14 cm 09141-14
5 1/2"

DEAVER

09150-14 14 cm 09151-14
5 1/2"



MAYO

09160-14 14,5 cm 09161-14
09164-14 TC 14,5 cm 09165-14 TC
5 3/4"

09160-17 17,0 cm 09161-17
09164-17 TC 17,0 cm 09165-17 TC
6 3/4"

09160-23 23,0 cm 09161-23
09164-23 TC 23,0 cm 09165-23 TC
9"

MAYO-STILLE

09170-15 15,0 cm 09171-15
09174-15 TC 15,0 cm 09175-15 TC
6"

09170-17 17,0 cm 09171-17
09174-17 TC 17,0 cm 09175-17 TC
6 3/4"

09170-21 21,0 cm 09171-21
09174-21 TC 21,0 cm 09175-21 TC
8 1/4"

MAYO-NOBLE

09180-17 17,0 cm 09181-17
6 3/4"

Präparierscheren
Dissecting Scissors
Tijeras de disección
Forbici per dissezione



LEXER
09190-16
09194-16 TC
16 cm, 6 1/4"

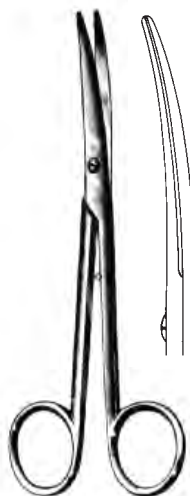

LEXER
09191-16
09195-16 TC
16 cm, 6 1/4"



LEXER BABY
09202-10 09203-10
09206-10 TC 09207-10 TC
10 cm, 4"

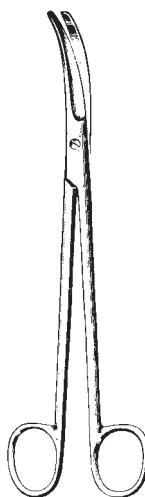

JORGENSEN
09204-22
22 cm, 8 3/4"

Präparierscheren
Dissecting Scissors
Tijeras de disección
Forbici per dissezione



METZENBAUM	
09280-12	09284-12 TC
12 cm	4 3/4"
09280-15	09284-15 TC
15 cm	6"
09280-18	09284-18 TC
18 cm	7"
09280-20	09284-20 TC
20 cm	8"
09280-23	09284-23 TC
23 cm	9"
09280-25	09284-25 TC
25 cm	10"
09280-28	09284-28 TC
28 cm	11"
09280-30	09284-30 TC
30 cm	12"



METZENBAUM	
09281-12	09285-12 TC
12 cm	4 3/4"
09281-15	09285-15 TC
15 cm	6"
09281-18	09285-18 TC
18 cm	7"
09281-20	09285-20 TC
20 cm	8"
09281-23	09285-23 TC
23 cm	9"
09281-25	09285-25 TC
25 cm	10"
09281-28	09285-28 TC
28 cm	11"
09281-30	09285-30 TC
30 cm	12"



METZENBAUM FINO	
09282-15	09286-15 TC
15 cm	6"
09282-18	09286-18 TC
18 cm	7"
09282-20	09286-20 TC
20 cm	8"
09282-23	09286-23 TC
23 cm	9"
09282-25	09286-25 TC
25 cm	10"
09282-28	09286-28 TC
28 cm	11"



METZENBAUM FINO	
09283-15	09287-15 TC
15 cm	6"
09283-18	09287-18 TC
18 cm	7"
09283-20	09287-20 TC
20 cm	8"
09283-23	09287-23 TC
23 cm	9"
09283-25	09287-25 TC
25 cm	10"
09283-28	09287-28 TC
28 cm	11"

Präparierschere / Kapselschere
Dissecting Scissors / Capsula Scissor
Tijeras de disección / Tijera p. cápsula
Forbici per dissezione / Forbici per capsula

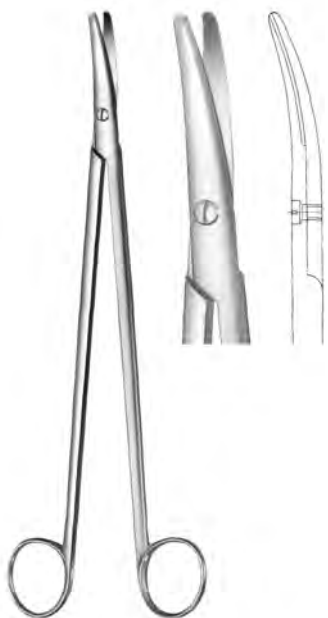

WELLER
09289-28
28 cm, 11"



RESANO
09290-25
25 cm, 10"

Chirurgische Scheren, fein
 Operating Scissors, fine
 Tijeras para cirugía, finas
 Forbici per chirurgia, fine



METZENBAUM "S"

09291-18 18 cm, 7" **09295-18 TC**
 09291-20 20 cm, 8" **09295-20 TC**
 09291-23 23 cm, 9" **09295-23 TC**

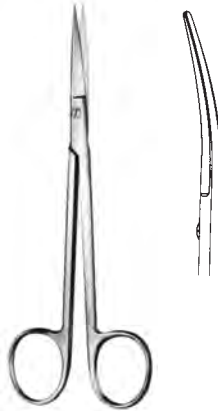

SANVENERO

09302-14 14 cm 09303-14
 5 1/2"

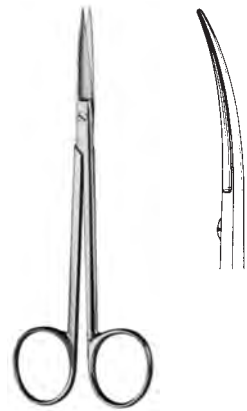

JOSEPH

09304-14 14 cm 09305-14
 5 1/2"

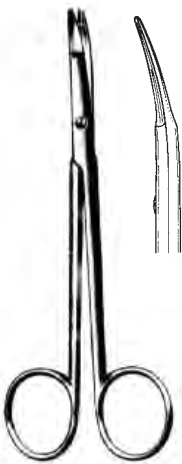

KILNER

09310-12 12 cm **09314-12 TC**
 09310-15 15 cm
 09312-12 12 cm gerade/straight/recta/retta

9 cm 3 1/2"
 10 cm 4"
 11 cm 4 3/8"
 12 cm 4 3/4"
 15 cm 6"



REYNOLDS

09320-15 15 cm 09321-15
 09321-18

09325-15 TC

Iris - Standard

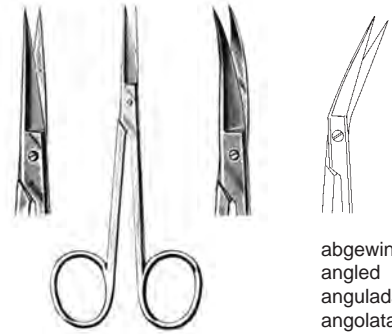

abgewinkelt
 angled
 angulada
 angolata

09340-09 9 cm 09341-09 09346-11 11 cm
 09340-10 10 cm 09341-10
 09340-11 11 cm 09341-11
09344-11 TC **09345-11 TC**

Chirurgische Scheren, fein
Operating Scissors, fine
Tijeras para cirugía, finas
Forbici per chirurgia, fine

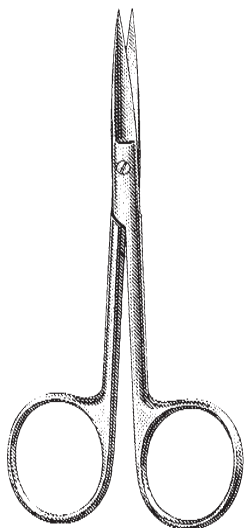

— KNAPP —
10 cm, 4"
09348-01 09348-02

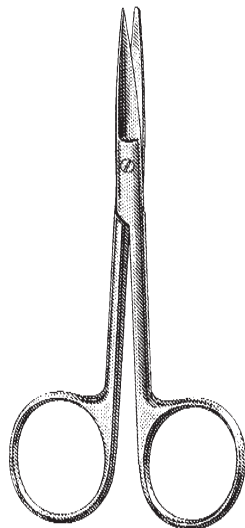

— KNAPP —
10 cm, 4"
09348-03 09348-04

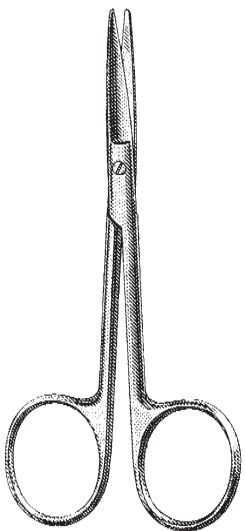

— KNAPP —
10 cm, 4"
09348-05 09348-06

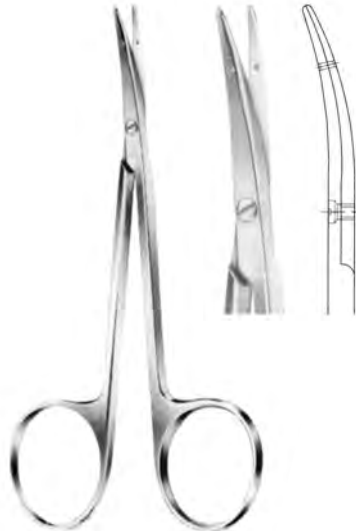

LITTLER
12 cm, 4 3/4"
09349-12

Präparierscheren, feines Modell
Dissecting Scissors, fine pattern
Tijeras de disección, finas
Forbici per preparazione, modello fino



GRAEFE
09350-10
100 mm
4"



COTTLE
09358-11
115 mm
4 1/2"

Scheren, Ophthalmologie
 Scissors, Ophtalmology
 Tijeras, oftalmología
 Forbici, per oftalmologia



GRADLE

09350-09 09351-09
 9,5 cm, 3 3/4"

gerade	gebogen
straight	curved
rectas	curvas
retta	curva



09352-09 09353-09
 9,5 cm, 3 3/4"

gerade	gebogen
straight	curved
rectas	curvas
retta	curva



09354-10 09355-10
 10 cm, 4"

gerade	gebogen
straight	curved
rectas	curvas
retta	curva



09356-10 09357-10
 10 cm, 4"

gerade	gebogen
straight	curved
rectas	curvas
retta	curva

Scheren, Ophthal, Nase
 Scissors, Ophthal, Nasal
 Tijeras, oftalmología, nasales
 Forbici, oftalmologia, nasali

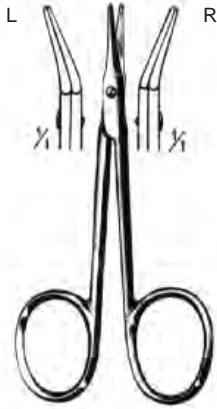

AEBLI
 09347-09 9 cm 09349-09
 3 1/2"



STEVENS
 11 cm
 4 3/8"



09360-11 09361-11
 09362-11 09363-11



ENUCLEATION
 09381-11
 13 cm, 5 1/8"



STRABISMUS
 09370-11 09371-11
 09374-11 TC 09375-11 TC
 11 cm, 4 3/8"



HEYMANN
 09401-18
 18 cm, 7"



FOMON
 09403-15
 15 cm, 6"

Tonsillen-, Gefäßscheren
 Tonsil, Vascular Scissors
 Tijeras, amígdalas y vasculares
 Forbici per tonsilli e vascolari



COTTLE
 09405-16
09406-16 TC
 16 cm, 6 1/4"



DEAN
 09425-17 09427-17
 17 cm, 6 3/4"



BOETTCHER
 09435-18
 18 cm, 7"



GOOD
 09437-19
 19 cm, 7 1/2"

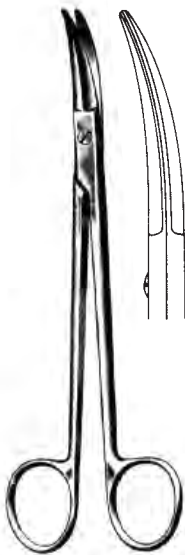

PRINCE
 09439-17
 17 cm, 6 3/4"



09468-15
 15 cm, 6"



09470-11
 11 cm, 4 3/8"

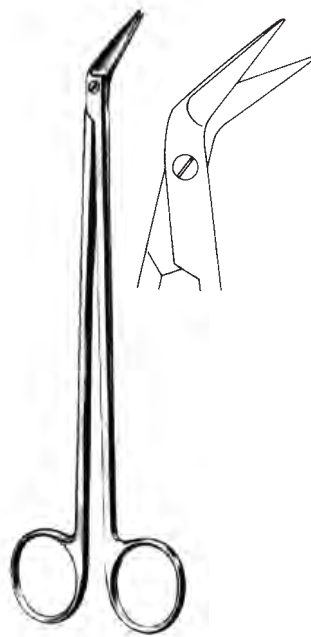

POTTS-DE MARTEL
 09473-21
 21 cm, 8 1/4"

Scheren, Thorax und GefäÙe
 Scissors, thorax and vascular
 Tijeras, torácicas y vasculares
 Forbici vascolari e toraciche



09475-25
09476-25 TC
 18 cm, 7"

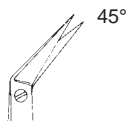

09475-45
09476-45 TC
 18 cm, 7"

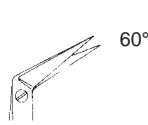

09475-60
09476-60 TC
 17,5 cm, 6.9"



09475-90
09476-90 TC
 17 cm, 6 3/4"



09475-00
09476-00 TC
 17 cm, 6 3/4"

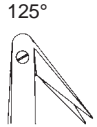

DIETRICH
 09477-01
 17 cm, 6 3/4"

DIETRICH
 09475-25 – 09475-00
 17 cm, 6 3/4"

Scheren mit Hartmetalleinsätzen
 Scissors with Tungsten Carbide
 Tijeras con carburo de tungsteno
 Forbici con carburo di tungsteno



De Bakey
 (Potts-Smith)



09478-25
 19 cm
 7 1/2"



09478-45
 19 cm
 7 1/2"



09478-60
 19 cm
 7 1/2"



09479-25
 23 cm
 9"



09479-45
 23 cm
 9"



09479-60
 23 cm
 9"

Gefäßscheren
 Vascular Scissors
 Tijeras vasculares
 Forbici vascolari



POTTS-SMITH
 19 cm, 7 1/2"

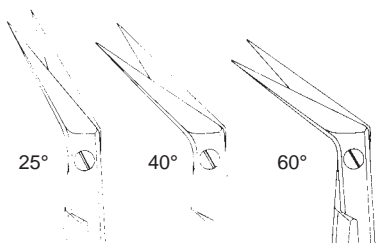

09480-25
09481-25 TC
 09480-40
09481-40 TC
 09480-60
09481-60 TC

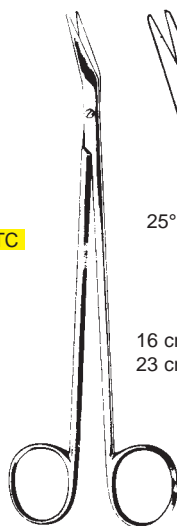

DE BAKEY

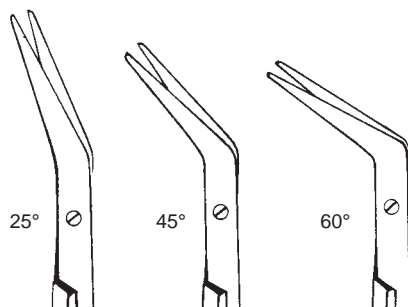

16 cm 09490-16 09491-16 09492-16
 23 cm 09490-23 09491-23 09492-23

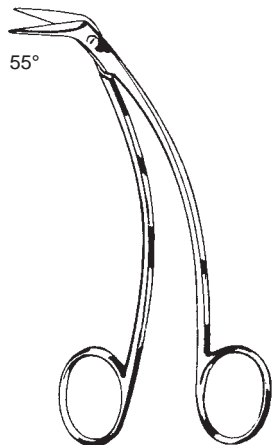

FAVALORO
 09496-15 15 cm, 6"

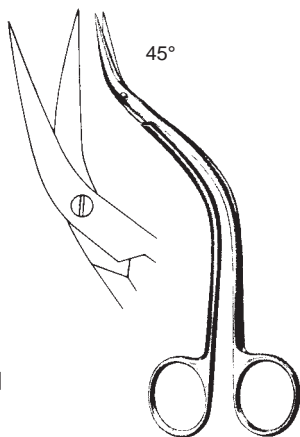

DE BAKEY
 09497-15 15,5 cm, 6"



KELLY
 09540-16 09541-16
09542-16 TC 09543-16 TC
 16 cm, 6 1/4"

Gynäkologische Scheren
 Gynecological Scissors
 Tijeras ginecológicas
 Forbici ginecologiche



SIMS

09510-20 20 cm, 8" 09511-20
 09510-23 23 cm, 9" 09511-23

09516-23 TC 23 cm, 9" 09517-23 TC



09512-20
 09512-23



09513-20
 09513-23



09514-20
 09514-23



09515-20
 09515-23

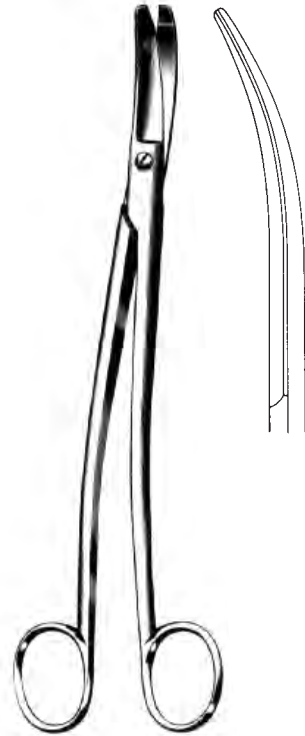

SIEBOLD

09523-24 24 cm, 9 1/2"

Gynäkologische Scheren
 Gynecological Scissors
 Tijeras ginecológicas
 Forbici ginecologiche

Parametrium



09501-22 22,5 cm, 8.9"

09505-22 TC 22,5 cm, 8.9"

09501-23 23 cm, 9"

09505-23 TC 23 cm, 9"



WERTHEIM

09525-22 22,5 cm, 8.9"



DOYEN

09530-17 09531-17

17,5 cm, 6.9"



DUBOIS

09536-27 09537-27

27 cm, 10 1/2"

Chirurgische Scheren
 Operating Scissors
 Tijeras para cirugía
 Forbici per chirurgia



gezahnt
 saw edge
 dentadas
 dentellata

WALDMANN
 09548-18
 18 cm, 7"



U.S.A. Mod.
 09550-10
 10,5 cm, 4"



BUSCH
 09551-16
 16 cm, 6 1/4"



SCHUMACHER
 09553-16
 16 cm, 6 1/4"



BRAUN-STADLER
 09560-14 14,5 cm, 5 3/4"
 09560-22 22,0 cm, 8 3/4"

Chirurgische Scheren
Operating Scissors
Tijeras para cirugía
Forbici per chirurgia

Neurochirurgie - Neurosurgery - Neurocirugía - Neurochirurgia



09580-11 09581-11
11 cm, 4 3/8"

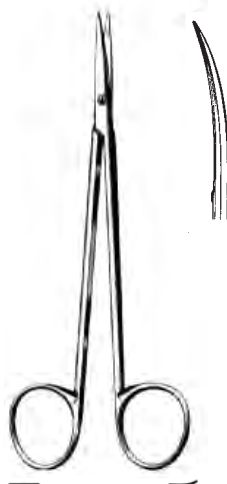

09582-15 09583-15
15 cm, 6"

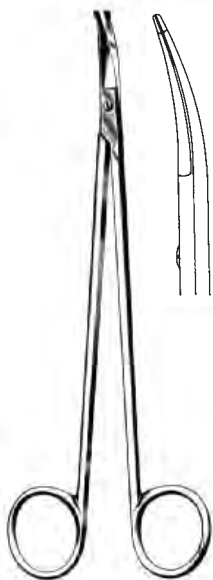

STRULLY
09601-22
22 cm, 8 3/4"



TOENNIS-ADSON
09610-18
18 cm, 7"

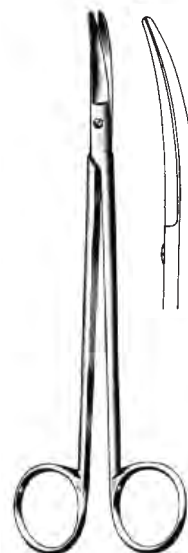

TOENNIS-ADSON
09611-18
18 cm, 7"

Chirurgische Scheren
Operating Scissors
Tijeras para cirugía
Forbici per chirurgia



gezahnt
saw edge
dentadas
dentellata

MARTIN CARTILAGE
09613-20
20 cm, 8"



McINDOE
09614-19
19 cm, 7 1/2"



FOMON
09617-13
13 cm, 5 1/8"

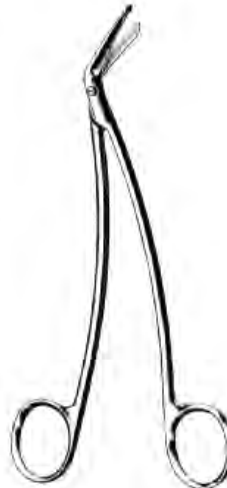

SCHMIEDEN-TAYLOR
09619-17
17 cm, 6 3/4"

Chirurgische Scheren
Operating Scissors
Tijeras para cirugía
Forbici per chirurgia

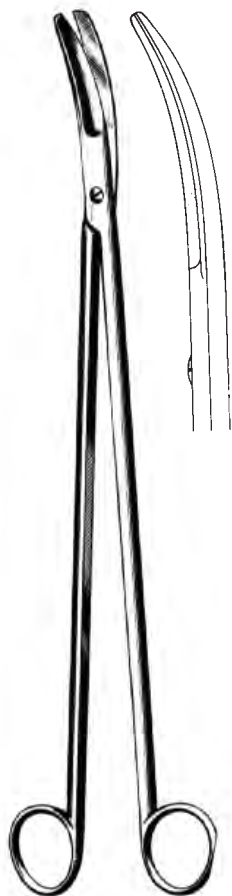

CRAFOORD
09641-30
30 cm, 11 3/4"



THOREK
09643-19 19 cm, 7 1/2"
09643-25 25 cm, 10"

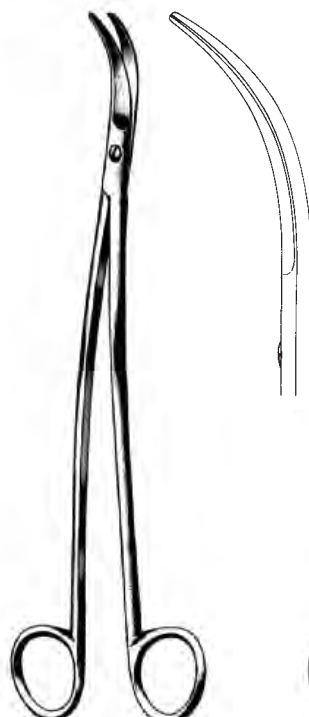

SATINSKY
09651-24
24,5 cm, 9 1/2"

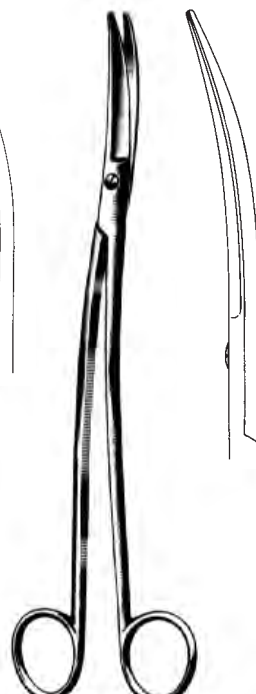

KLINKENBERGH-LOTH
09661-23
23 cm, 9"

Chirurgische Scheren
Operating Scissors
Tijeras para cirugía
Forbici per chirurgia

Darmscheren
Enterotomy Scissors
Enterótomos
Forbici per enterotomia



FERGUSSON
09770-18
18 cm, 7"



09772-21
21 cm, 8 1/4"



09774-21
21 cm, 8 1/4"

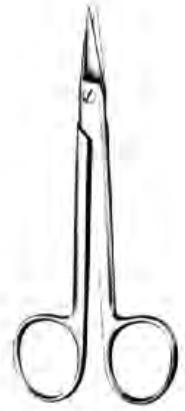

— SYSTRUNK —
09775-13 09777-13
13 cm, 5 1/8"

Ligaturscheren, Fadenscheren
Ligature Scissors
Tijeras para ligaduras
Forbici per legature



SPENCER
09802-09
9 cm, 3 1/2"



SPENCER
09802-11
11 cm, 4 3/8"



NORTHBENT
09803-09 9 cm, 3 1/2"
09803-13 13 cm, 5 1/8"



LITTAUER
09804-14
14 cm, 5 1/2"



HEATH
09809-15
15 cm, 6"

Chirurgische Scheren
 Operating Scissors
 Tijeras para cirugía
 Forbici per chirurgia

Zahnfleischscheren
Gum Scissors
Tijeras para encías
Forbici gengivali

1 Schneide gezahnt
 1 blade toothed
 1 hoja dentada
 1 taglio della lama dentellato

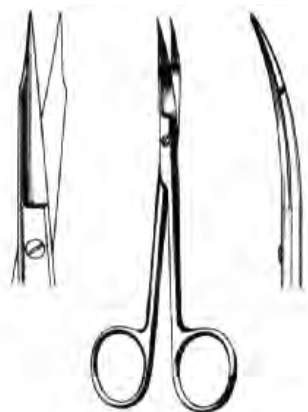

— GOLDMAN-FOX —
 09820-13 13 cm, 5 1/8" 09821-13

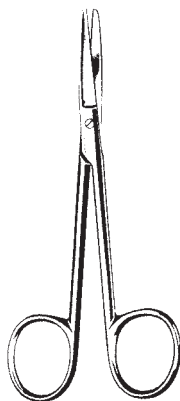

WAGNER
 12 cm, 4 3/4"

gerade
 straight
 rectas
 rette

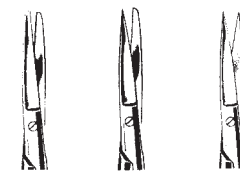

Fig. 1 09828-12 Fig. 2 09826-12 Fig. 3 09824-12

gebogen
 curved
 curvas
 curve

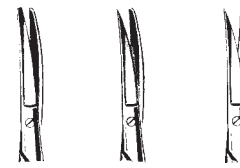

Fig. 1 09823-12 Fig. 2 09829-12 Fig. 3 09825-12

Draht-, Blechscherer
Wire and plate shears
Tijeras para alambre y láminas
Forbici per filo di metallo e lamiera



QUINBY
 09827-12 12 cm, 4 3/4"



UNIVERSAL
 09831-12 12 cm, 4 3/4"
 09835-12 TC 12 cm, 4 3/4"

Beebee Kronenscheren
 Beebee Crown Scissors
 Beebee Tijeras para coronas
 Beebee Forbici per corona



Beebee

09850-10
 gerade 10,5 cm (4") spitz
 straight 10,5 cm (4") pointed
 rectas 10,5 cm (4") agudas
 rette 10,5 cm (4") acute

09852-10
 gerade 10,5 cm (4") stumpf
 straight 10,5 cm (4") blunt
 rectas 10,5 cm (4") romas
 rette 10,5 cm (4") smusse

09851-10
 gebogen 10,5 cm (4") spitz
 curved 10,5 cm (4") pointed
 curvas 10,5 cm (4") agudas
 curve 10,5 cm (4") acute

09853-10
 gebogen 10,5 cm (4") stumpf
 curved 10,5 cm (4") blunt
 curvas 10,5 cm (4") romas
 curve 10,5 cm (4") smusse

Zahnfleischscheren
Gum Scissors
Tijeras para encias
Forbici gengivali



LA Grange
09854-11
11,5 cm, 4 1/2"



gezahnt
saw edge
dentadas
dentellata

LOCKLIN
09859-16
16 cm, 6 1/4"



gezahnt
saw edge
dentadas
dentellata

LOCKLIN
09860-16
16,5 cm , 6 1/2"



LOCKLIN
09861-16 TC
16,5 cm, 6 1/2"

Verbandscheren
 Bandage Scissors
 Tijeras para vendajes
 Forbici per bendaggi

Gaze
 Gauze
 Gaza
 Garza



SMITH US ARMY
 09898-20
 20 cm, 8"



LISTER
 9 cm, 3 1/2" 09901-09
 11 cm, 4 3/8" 09901-11
 14 cm, 5 1/2" 09901-14 09905-14 TC
 18 cm, 7" 09901-18 09905-18 TC
 20 cm, 8" 09901-20



LISTER
 09906-18 18 cm, 7"
 09906-20 20 cm, 8"



BERGMANN
 09911-23
 23 cm, 9"

Verbandscheren
Bandage Scissors
Tijeras para vendajes
Forbici per bendaggi



ESMARCH
09913-20 20 cm, 8"
09913-22 22 cm, 8 3/4"



SEUTIN
09915-23
23 cm, 9"

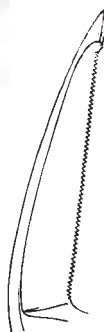

gezahnt
toothed
dentadas
dentellata

REDA EXCENTER
09921-16 16 cm, 6 1/4"
09921-19 19 cm, 7 1/2"

Verbandscheren
Bandage Scissors
Tijeras para vendajes
Forbici per bendaggi



KNOWLES
09930-14
14 cm, 5 1/2"



KNOWLES
09931-14
14 cm, 5 1/2"



LORENZ
09933-23
23 cm, 9"



BRUNS
09935-23 23 cm, 9" **09939-23 TC**
09937-23 23 cm, 9"



09941-20
20 cm, 8"

in verschiedenen Farben lieferbar
in different colours available
en diferentes colores disponibles
in differenti colori disponibile



UNIVERSAL
09950-15 15 cm, 6"
09950-18 18 cm, 7"

Supercut Scheren
 Supercut Scissors
 Tijeras Supercut
 Forbici Supercut



gezahnt
 saw edge
 dentadas
 dentellate

09960-14 09961-14
 14,5 cm, 5 3/4"

gerade gebogen
 straight curved
 rectas curvas
 rette curve



gezahnt
 saw edge
 dentadas
 dentellate

MAYO
 09962-14 14,5 cm 09963-14
 09962-17 17,0 cm 09963-17
 09962-23 23,0 cm 09963-23
 gerade gebogen
 straight curved
 rectas curvas
 rette curve



gezahnt
 saw edge
 dentadas
 dentellate

MAYO-STILLE
 09964-15 15,0 cm 09965-15
 09964-17 17,0 cm 09965-17
 gerade gebogen
 straight curved
 rectas curvas
 rette curve



gezahnt
 saw edge
 dentadas
 dentellate

BABY METZENBAUM
 09966-11 09967-11
 11,5 cm, 4 1/2"
 gerade gebogen
 straight curved
 rectas curvas
 rette curve



gezahnt
 saw edge
 dentadas
 dentellate

METZENBAUM
 09970-14 14,5 cm 09971-14
 09970-18 18,0 cm 09971-18
 09970-20 20,0 cm 09971-20
 09970-23 23,0 cm 09971-23
 gerade gebogen
 straight curved
 rectas curvas
 rette curve

Supercut Scheren
Supercut Scissors
Tijeras Supercut
Forbici Supercut



gezahnt
saw edge
dentadas
dentellate

IRIS

09980-11 09981-11
11,5 cm, 4 1/2"

gerade	gebogen
straight	curved
rectas	curvas
rette	curve



gezahnt
saw edge
dentadas
dentellate

WAGNER

09982-12 09983-12
12 cm, 4 3/4"

gerade	gebogen
straight	curved
rectas	curvas
rette	curve



STEVENS

09984-11 09985-11
11,5 cm, 4 1/2"

gerade	gebogen
straight	curved
rectas	curvas
rette	curve



gezahnt
saw edge
dentadas
dentellate

LaGrange

09986-11 11,5 cm, 4 1/2"



gezahnt
saw edge
dentadas
dentellate

LISTER

09990-14 14,5 cm, 5 3/4"
09990-18 18,0 cm, 7"



REYNOLDS

09993-15 15 cm, 6"
09993-18 18 cm, 7"



KILNER/RAGNELL

09995-12 12 cm, 4 3/4"

Face Lift Scheren
 Face Lift Scissors
 Tijeras Face Lift
 Forbici Face Lift



GORNEY FACE LIFT
 19 cm, 7 1/2"



10010-19
10012-19 TC
 10014-19 Supercut



10011-19
10013-19 TC
 10015-19 Supercut



REES FACE LIFT

- 10016-17 — 17,0 cm, 6 3/4"
- 10017-17 — 17,0 cm, 6 3/4"
- 10018-20 — 20,5 cm, 8"
- 10019-20 — 20,5 cm, 8"

TC

- 10020-17** — 17,0 cm, 6 3/4"
- 10021-17** — 17,0 cm, 6 3/4"
- 10022-20** — 20,5 cm, 8"
- 10023-20** — 20,5 cm, 8"

Supercut

- 10024-17 — 17,0 cm, 6 3/4"
- 10025-17 — 17,0 cm, 6 3/4"
- 10026-20 — 20,5 cm, 8"
- 10027-20 — 20,5 cm, 8"



KAYE FACE LIFT

TC

- 10028-14** — 14,5 cm, 5 3/4"
- 10029-14** — 14,5 cm, 5 3/4"
- 10030-18** — 18,5 cm, 7 1/4"
- 10031-18** — 18,5 cm, 7 1/4"
- 10032-23** — 23,0 cm, 9"
- 10033-23** — 23,0 cm, 9"



Supercut

- 10034-14 — 14,5 cm, 5 3/4"
- 10035-14 — 14,5 cm, 5 3/4"
- 10036-18 — 18,5 cm, 7 1/4"
- 10037-18 — 18,5 cm, 7 1/4"
- 10038-23 — 23,0 cm, 9"
- 10039-23 — 23,0 cm, 9"

Face Lift Scheren
 Face Lift Scissors
 Tijeras Face Lift
 Forbici Face Lift









FREEMAN FACE LIFT

10040-18		18 cm, 7"
10041-18 TC		18 cm, 7"
10042-18 Supercut		18 cm, 7"



PECK JOSEPH

10044-14		14,5 cm, 5 3/4"
10045-14		14,5 cm, 5 3/4"
10046-14 TC		14,5 cm, 5 3/4"
10047-14 TC		14,5 cm, 5 3/4"
10048-14 Supercut		14,5 cm, 5 3/4"
10049-14 Supercut		14,5 cm, 5 3/4"

Augenscheren
 Ophthalmic Scissors
 Tijeras oculares
 Forbici oculistiche



WESTCOTT
 10102-11
 11 cm, 4 3/8"



WESTCOTT
 10104-11
 11 cm, 4 3/8"



NOYES
 10110-12 10111-12
 12 cm, 4 3/4"



WECKER
 11 cm, 4 3/8"



10113-11



10115-11



10117-11



BARRAQUER
 10119-10 5,5 cm, 2.2"
 (Colibri)

Mikro-Scheren
 Micro-Scissors
 Micro-Tijeras
 Micro-Forbici



10120-16
 10120-18
 10120-22

16,0 cm, 6 1/4"
 18,5 cm, 7 1/4"
 22,5 cm, 8.9"



10121-16
 10121-18
 10121-22



10122-16
 10122-18
 10122-22

16,0 cm, 6 1/4"
 18,5 cm, 7 1/4"
 22,5 cm, 8.9"



10123-16
 10123-18
 10123-22



10124-16
 10124-18
 10124-22

16,0 cm, 6 1/4"
 18,5 cm, 7 1/4"
 22,5 cm, 8.9"



10125-16
 10125-18
 10125-22

Circumflex

Mikro-Scheren
Micro-Scissors
Micro-Tijeras
Micro-Forbici



25°

10126-25

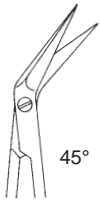

45°

10126-45

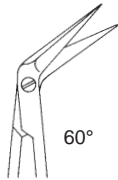

60°

10126-60



Reda
18 cm, 7"



25°

10127-25



45°

10127-45

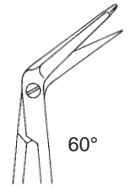

60°

10127-60

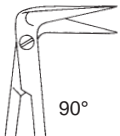

90°

10126-90

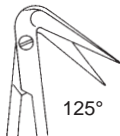

125°

10126-00

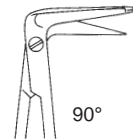

90°

10127-90

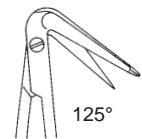

125°

10127-00

Mikro-Scheren
 Micro-Scissors
 Micro-Tijeras
 Micro-Forbici



10128-09
 9 cm, 3 1/2"



10128-15 15 cm, 6"
 gerade
 straight
 rectas
 rette

10129-15 15 cm, 6"
 gebogen
 curved
 curvas
 curvo

10130-15 15 cm, 6"
 gebogen, 1 Schneide gezahnt
 curved, 1 blade toothed
 curvas, 1 hoja dentada
 curva, 1 lama dentellata

10128-15 - 10130-15
 15 cm, 6"

halbscharf
 semi-sharp
 medio roma
 lame semi smusse



Hepp-Scheidel
 10131-14 14 cm, 5 1/2"
 10131-16 16 cm, 6 1/4"



Hepp-Scheidel
 10132-18
 18 cm, 7"



Hepp-Scheidel
 10137-01
 18 cm, 7"
 spitz
 pointed
 agudas
 acute

Hepp-Scheidel
 10137-02
 18 cm, 7"
 stumpf
 blunt
 romas
 smusse

Augen-, Mikroscheren
 Ophthalmic, Micro Scissors
 Tijeras oculares, micro tijeras
 Forbici oculistiche, micro chirurg.

Iridektomie, Iridectomy, Iridectomía, iridectomia



CASTROVIEJO
 10133-10 10 cm, 4"



CASTROVIEJO
 10135-10 10 cm, 4"



VANNAS
 10140-08 8 cm, 3 1/8"



VANNAS
 10141-08 8 cm, 3 1/8"



10142-08
 kniegebogen
 angular
 acodada
 angolate



10143-08
 aufgewinkelt
 angled up
 acodada hacia arriba
 angolate verso l'alto

Hornhautscheren, Corneal scissors, Tijeras corneales, Forbici corneali



CASTROVIEJO
 10151-11 11 cm, 4 3/8"



CASTROVIEJO
 10153-11 11 cm, 4 3/8"



CASTROVIEJO
 10155-11 11 cm, 4 3/8"

Mikro-Scheren
 Micro-Scissors
 Micro-Tijeras
 Micro-Forbici



Reda
 10202-18 - 10203-18
 18 cm, 7"



GOMEL



10313-14
 14 cm
 5 1/2"



10313-16
 16 cm
 6 1/4"

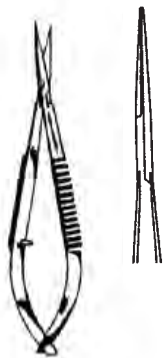

Reda micro
 10320-09
 9 cm, 3 1/2"



Reda
 10330-19 - 10333-19
 18,5 cm, 7 1/4"



10330-19



10331-19



10333-19

Anatomische und chirurgische Pinzetten
 Dressing and Tissue Forceps
 Pinzas de disección, sin/con dientes
 Pinze per dissezione, chirurgiche/anatomiche

STANDARD



USA

STILLE

cm		11102-10
10,5	4 1/4"	11102-11
11,5	4 1/2"	
12,0	4 3/4"	11102-13
13,0	5 1/8"	11102-14
14,5	5 3/4"	
15,0	6"	
15,5	6"	11102-16
16,0	6 1/4"	11102-18
18,0	7"	11102-20
20,0	8"	
21,0	8 1/4"	11102-25
25,0	10"	11102-30
30,0	12"	

11104-12

11104-13

11104-14

11104-15

11104-18

11104-21

11104-25

11106-13

11106-15

11103-14

 schmal
 narrow
 estrecha
 stretta

POTTS-SMITH

 POTTS-SMITH
 1x2

cm			
10,5	4 1/4"		
11,5	4 1/2"	11110-11	
12,0	4 3/4"		
13,0	5 1/8"	11110-13	
14,5	5 3/4"	11110-14	11114-14 TC
15,0	6"		
15,5	6"		
16,0	6 1/4"	11110-16	11114-16 TC
18,0	7"	11110-18	
20,0	8"	11110-20	11114-20 TC
21,0	8 1/4"		
25,0	10"	11110-25	11114-25 TC
30,0	12"	11110-30	

11112-18

11112-21

11112-25

11116-18 TC

11116-21 TC

11116-25 TC

11126-18

11126-21

11126-25



Chirurgische Pinzetten
Tissue Forceps
Pinzas de disección, con dientes
Pinze per dissezione, chirurgiche

STANDARD



1x2



USA



STILLE



schmal
narrow
estrecha
stretta

1x2

cm				
10,5	4 1/4"	11120-10		
11,5	4 1/2"	11120-11		11130-11
12,0	4 3/4"		11122-12	
13,0	5 1/8"	11120-13	11122-13	11130-13
14,5	5 3/4"	11120-14	11122-14	11130-14
15,0	6"			
15,5	6"		11122-15	
16,0	6 1/4"	11120-16		11130-16
18,0	7"	11120-18	11122-18	11130-18
20,0	8"	11120-20		11130-20
21,0	8 1/4"		11122-21	
25,0	10"	11120-25	11122-25	
30,0	12"	11120-30		



OEHLER



2x3



3x4



4x5

cm				
10,5	4 1/4"			
11,5	4 1/2"		11140-11	
12,0	4 3/4"			
13,0	5 1/8"		11140-13	11150-13
14,5	5 3/4"		11140-14	11150-14
15,0	6"			
15,5	6"			
16,0	6 1/4"	11132-16 TC	11140-16	11150-16
18,0	7"	11132-18 TC	11140-18	11160-14
20,0	8"	11132-20 TC	11140-20	
21,0	8 1/4"			
25,0	10"	11132-25 TC	11140-25	
30,0	12"	11132-30 TC		

Anatomische und chirurgische Pinzetten
 Dressing and Tissue Forceps
 Pinzas de disección, sin/con dientes
 Pinze per dissezione, chirurgiche/anatomiche



ADSON
 11170-12 12,0 cm, 4 3/4"
 11170-15 15,0 cm, 6"



ADSON
 11174-12 TC 12,0 cm, 4 3/4"
 11174-15 TC 15,0 cm, 6"



ADSON micro
 11176-12 12,0 cm, 4 3/4"
 11176-15 15,0 cm, 6"



Adson-DeBakey atraumatic
 11177-12
 12,0 cm, 4 3/4"



ADSON
 11178-12
 12,0 cm, 4 3/4"



ADSON
 11179-12
 12 cm, 4 3/4"

1x2

2x3

Anatomische und chirurgische Pinzetten
 Dressing and Tissue Forceps
 Pinzas de disección, sin/con dientes
 Pinze per dissezione, anatomiche/chirurgiche



1x2

ADSON

11180-12 12,0 cm, 4 ³/₄"
 11180-15 15,0 cm, 6"

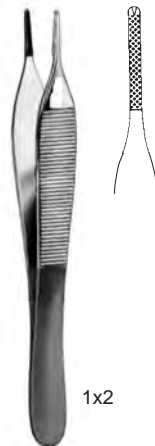

1x2

ADSON

11181-12 TC 12,0 cm, 4 ³/₄"
 11181-15 TC 15,0 cm, 6"



1x2

ADSON micro

11186-12 12,0 cm, 4 ³/₄"
 11186-15 15,0 cm, 6"



1x2

ADSON

11187-12
 12 cm, 4 ³/₄"



7x7

ADSON-BROWN

11188-12 12,0 cm, 4 ³/₄"
 11188-15 15,0 cm, 6"
 11189-12 TC 12,0 cm, 4 ³/₄"

Anatomische und chirurgische Pinzetten
 Dressing and Tissue Forceps
 Pinzas de disección, sin/con dientes
 Pinze per dissezione, chirurgiche/anatomiche



9x9

BROWN
 11189-15 15,0 cm, 6"
 11189-20 20,0 cm, 8"
 11189-25 25,0 cm, 10"



GRAEFE
 11190-10 10,5 cm, 4.1"



1x2

WAUGH
 11187-18 18 cm, 7"
 11187-20 20 cm, 8"
 11187-25 25 cm, 10"
 11187-30 30 cm, 11 3/4"



17 cm
 6 3/4"

CUSHING
 11220-17
11224-17 TC
 17,0 cm, 6 3/4"



17 cm
 6 3/4"

CUSHING
 11222-17
11225-17 TC



5x6

LERCHE
 11232-15
 15,0 cm, 6"

Anatomische und chirurgische Pinzetten, Faßpinzetten
 Dressing and Tissue Forceps
 Pinzas de disección, sin/con dientes
 Pinze per dissezione, chirurgiche/anatomiche



BROPHY
 11231-20
 20,0 cm, 8"



BROPHY
 11233-20
 20,0 cm, 8"



11234-20



11235-20

BROPHY



4x5

ADLERKREUTZ
 11236-15 15,0 cm, 6"
 11236-20 20,0 cm, 8"



DUEHRSEN
 11237-20
 20 cm, 8"



1x2

LANE
 11240-14
 14,5 cm, 5 3/4"



2x3

LANE
 11242-14
 14,5 cm, 5 3/4"

Anatomische und chirurgische Pinzetten, Faßpinzetten
 Dressing and Tissue Forceps
 Pinzas de disección, sin/con dientes
 Pinze per dissezione, chirurgiche/anatomiche



FERRIS-SMITH
 11246-18
 18,0 cm, 7"



FERRIS-SMITH
 11248-18
 18,0 cm, 7"



DUVAL
 11250-14
 14,5 cm, 5 3/4"



COLLIN-DUVAL
 11252-20
 20,0 cm, 8"



Russ. Mod.
 11256-15 15,0 cm, 6"
 11256-20 20,0 cm, 8"
 11256-25 25,0 cm, 10"



McINDOE
 11257-15
 15,0 cm, 6"



McINDOE
 11258-15 15,0 cm, 6"
 11259-15 TC 15,0 cm, 6"

Anatomische und chirurgische Pinzetten
 Dressing and Tissue Forceps
 Pinzas de disección, sin/con dientes
 Pinze per dissezione, chirurgiche/anatomiche



SEMKEN
 11260-12 12,5 cm, 5"
 11260-15 15,5 cm, 6"
 11261-15 TC 15,5 cm, 6"



SEMKEN
 11270-12 12,5 cm, 5"
 11270-15 15,5 cm, 6"
 11271-15 TC 15,5 cm, 6"
 11271-18 TC 18 cm, 7"



GILLIES
 11272-15 15,5 cm, 6"
 11273-15 TC 15,5 cm, 6"



15,5 cm, 6"



GERALD
 11302-17 17,5 cm, 6.9"
 11302-23 23,0 cm, 9"
 11304-17 TC 17,0 cm, 6 3/4"



GERALD
 11303-17
 17,5 cm, 6.9"

Anatomische und chirurgische Pinzetten
 Dressing and Tissue Forceps
 Pinzas de disección, sin/con dientes
 Pinze per dissezione, chirurgiche/anatomiche



GERALD
 11305-17
 17,5 cm, 6.9"



GERALD
 11310-17 17,5 cm, 6.9"
 11312-17 TC 17,5 cm, 6.9"



GERALD
 11311-17
 17,5 cm, 6.9"



CUSHING-Taylor
 11312-18 TC
 18,5 cm, 7 1/4"



GERALD
 11313-17
 17,5 cm, 6.9"



11314-01
 17 cm, 6 3/4"



11314-02
 17 cm (6 3/4")
 1x2



11315-01
 17 cm, 6 3/4"



11315-02
 17 cm (6 3/4")
 1x2

Anatomische und chirurgische Pinzetten
 Dressing and Tissue Forceps
 Pinzas de disección, sin/con dientes
 Pinze per dissezione, chirurgiche/anatomiche

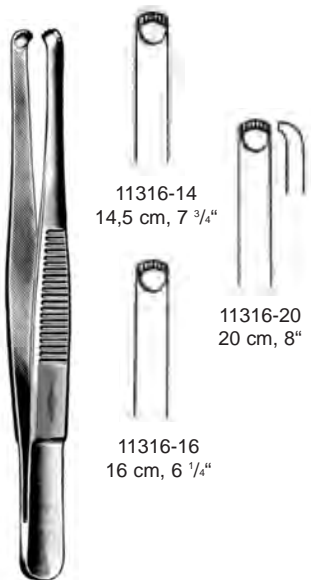

11316-14
 14,5 cm, 7 3/4"

11316-20
 20 cm, 8"

11316-16
 16 cm, 6 1/4"

DURANTE

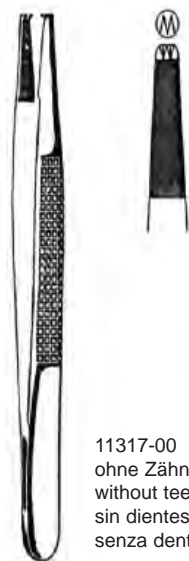

11317-12 1x2
 11317-23 2x3
 11319-12 TC 1x2

11317-00
 ohne Zähne
 without teeth
 sin dientes
 senza denti

BONNEY
 18 cm, 7"

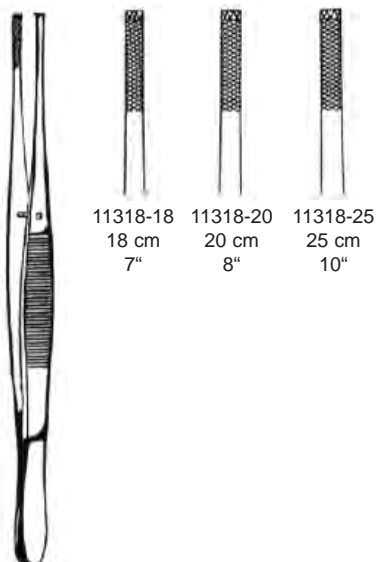

11318-18
 18 cm
 7"

11318-20
 20 cm
 8"

11318-25
 25 cm
 10"

STILLE-BARRAYA
 3x4

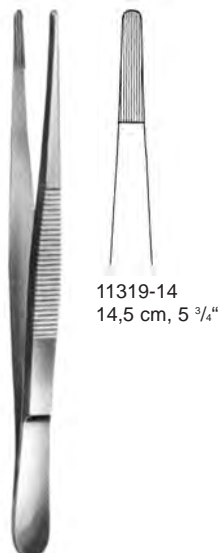

11319-14
 14,5 cm, 5 3/4"

OCHSNER



SINGLEY
 11320-18 18 cm 7"
 11320-23 23 cm 9"

Anatomische und chirurgische Pinzetten
 Dressing and Tissue Forceps
 Pinzas de disección, sin/con dientes
 Pinze per dissezione, chirurgiche/anatomiche



NELSON
 11322-15 15 cm 6"
 11322-18 18 cm 7"
 11322-23 23 cm 9"



WANGENSTEEN
 11324-23
 23 cm 9"



11325-15 TC
 15 cm, 6"

11325-23 TC
 23 cm, 9"

11325-25 TC
 25 cm, 10"

WANGENSTEEN



MAYO
 23 cm, 9"

11326-23



STRASSBURGER
 MODELL

1x2 Zähne

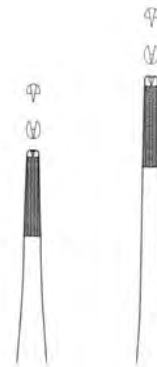

11328-15
 15 cm, 6"

11328-20
 20 cm, 8"

Splitterpinzetten
 Splinter Forceps
 Pinzas para espinas
 Pinze per schegge

Fig.: 1



11401-01
 12 cm, 4 $\frac{3}{4}$ "

3



11403-03
 12 cm, 4 $\frac{3}{4}$ "

3c



11403-04
 11 cm, 4 $\frac{3}{8}$ "

Fig.: 4



11404-04
 11 cm, 4 $\frac{3}{8}$ "

5



11405-05
 11 cm, 4 $\frac{3}{8}$ "

7



11407-07
 12 cm, 4 $\frac{3}{4}$ "

Splitterpinzetten
 Splinter Forceps
 Pinzas para espinas
 Pinze per schegge



11802-09 9,0 cm, 3 1/2"
 11802-10 10,5 cm, 4.1"
 11802-11 11,5 cm, 4 1/2"



FEILCHENFELD
 11810-07 7,5 cm, 3"
 11810-09 9,0 cm, 3 1/2"
 11810-11 11,5 cm, 4 1/2"



HUNTER
 11812-10 10,5 cm, 4.1"



HUNTER
 11813-10
 10,5 cm, 4.1"



HUNTER
 11815-12
 12,5 cm, 5"



CARMALT
 11816-10
 10,5 cm, 4.1"



CARMALT
 11817-10
 10,5 cm, 4.1"

Splitterzangen
 Splinter Forceps
 Pinzas para espinas
 Pinze per schegge



PEET
 11821-11
 11,5 cm, 4 1/2"



STIEGLITZ
 11822-13 11823-13
 13,5 cm, 5 1/4"



ARCHER
 11824-14 11825-14
 14 cm, 5 1/2"



VIRTUS (RALK)
 11828-15 11829-15
 15 cm, 6"

Zahnpinzetten
Dental Forceps
Pinzas dentales
Pinze dentali



LONDON-COLLEGE
11900-01
15 cm 6"



LONDON-COLLEGE
11901-05
15 cm 6"

mit Sperre
with lock
con cierre
con fermo



MERIAM
11910-01
15 cm 6"

Mikrochirurgie-Pinzetten
Microsurgery Forceps
Pinzas para microcirugía
Pinze per microchirurgia



12102-12
12 cm, 4 ³/₄"



12103-12
12 cm, 4 ³/₄"



12104-15
15 cm, 6"



12105-15
15 cm, 6"



12108-18
18 cm, 7"



12109-18
18 cm, 7"

Ultra-Light-Pinzetten
Ultra-Light-Forceps
Pinzas-Ultra-Ligera
Pinza-ultra-leggera

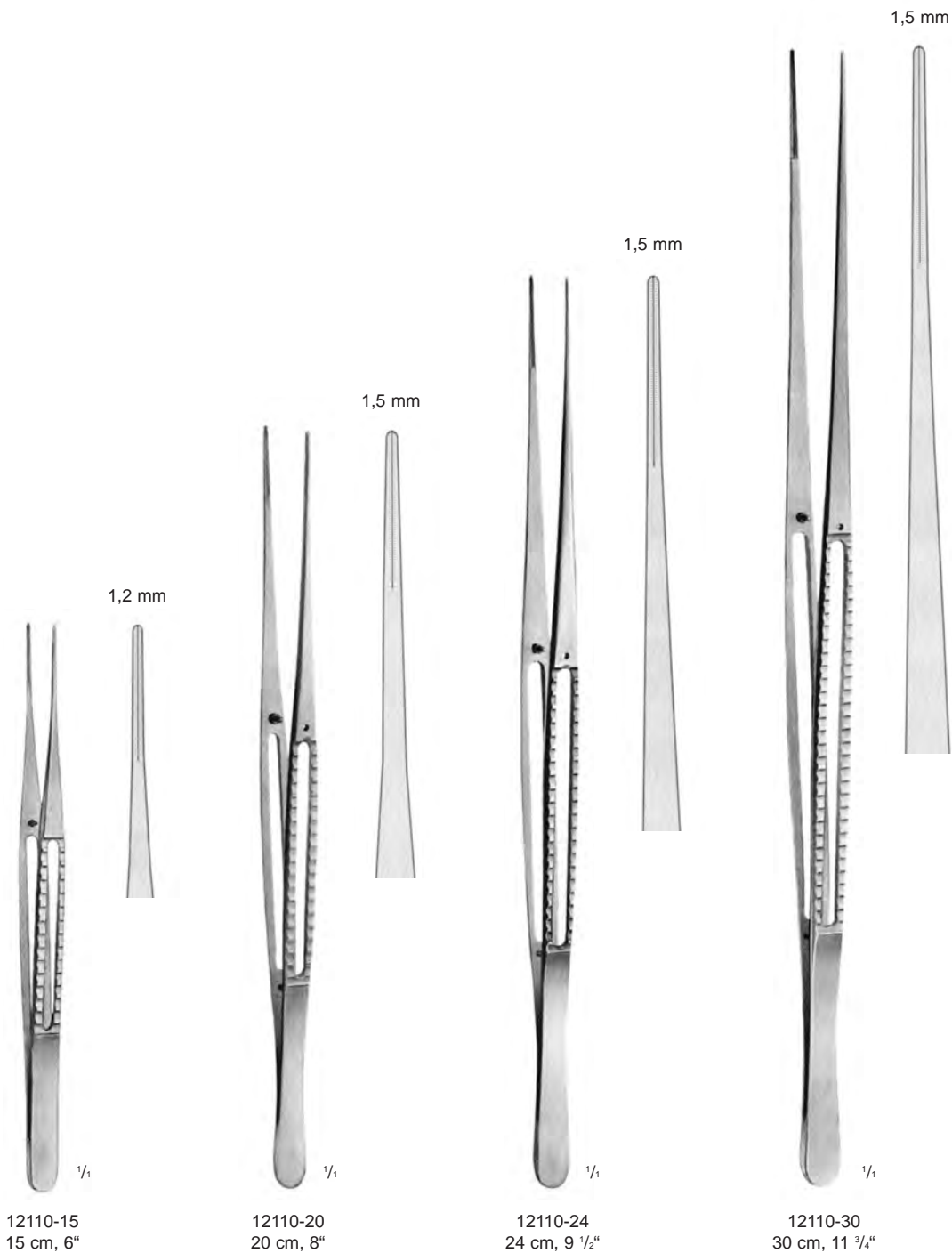

Mikrochirurgie-Pinzetten
Microsurgery Forceps
Pinzas para microcirugía
Pinze per microchirurgia

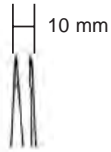
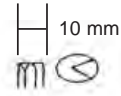

GOMEL
12200-16
16 cm, 6 1/4"



GOMEL
12201-16
16 cm, 6 1/4"

Tumorpinzetten
Tumor forceps
Pinzas para tumores
Pinze per tumori

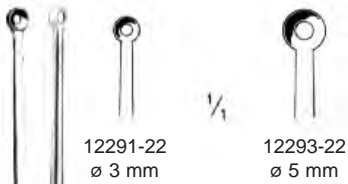

12291-22
ø 3 mm

12293-22
ø 5 mm

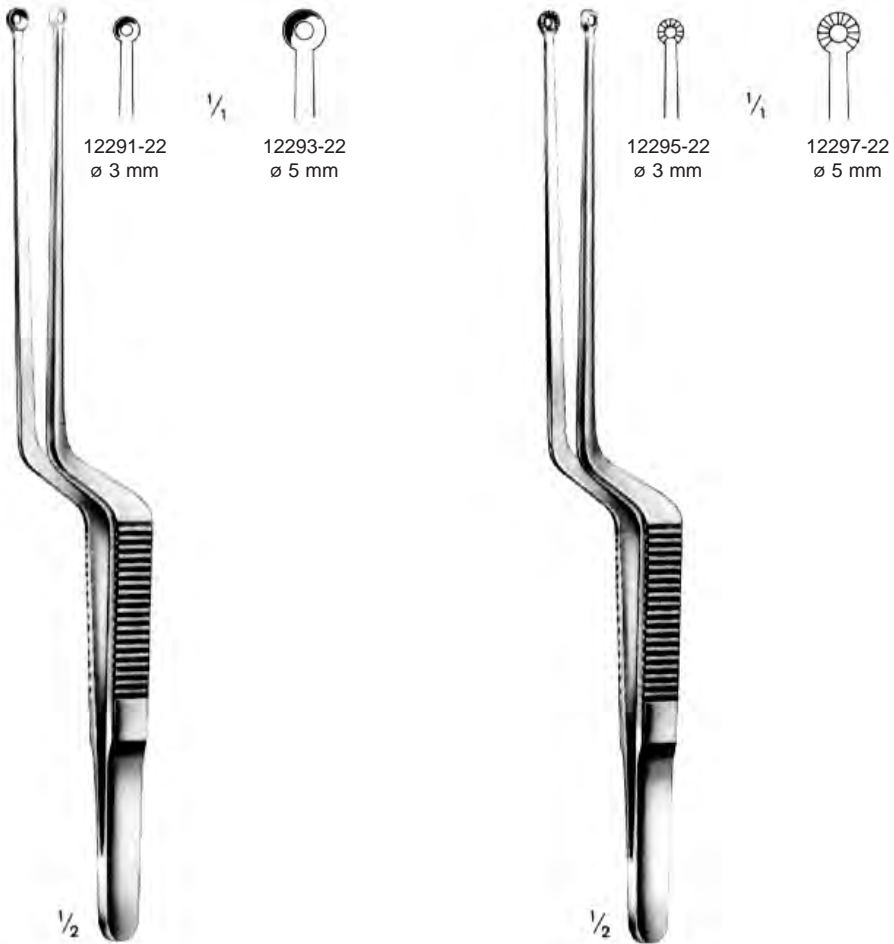

12295-22
ø 3 mm

12297-22
ø 5 mm

YASARGIL
12291-22 – 12293-22
22 cm, 8 3/4"

YASARGIL
12295-22 – 12297-22
22 cm, 8 3/4"

Atraumatische Pinzetten
 Atraumatic Tissue Forceps
 Pinzas atraumáticas
 Pinze atraumatiche



DE BAKEY
 12302-16 16 cm, 6 1/4"
 12302-20 20 cm, 8"
 12302-24 24 cm, 9 1/2"



DE BAKEY
 12306-16 16 cm, 6 1/4"
 12306-20 20 cm, 8"
 12306-24 24 cm, 9 1/2"
 12306-30 30 cm, 11 3/4"



DE BAKEY
 12308-16 16 cm, 6 1/4"
 12308-20 20 cm, 8"
 12308-24 24 cm, 9 1/2"
 12308-30 30 cm, 11 3/4"



DE BAKEY
 12309-16 16 cm, 6 1/4"
 12309-20 20 cm, 8"
 12309-24 24 cm, 9 1/2"
 12309-30 30 cm, 11 3/4"



DE BAKEY
 12304-16 16 cm, 6 1/4"
 12304-20 20 cm, 8"
 12304-24 24 cm, 9 1/2"
 12304-30 30 cm, 11 3/4"



DE BAKEY
 12310-16 16 cm, 6 1/4"
 12310-20 20 cm, 8"
 12310-24 24 cm, 9 1/2"
 12310-30 30 cm, 11 3/4"

Atraumatische Pinzetten
 Atraumatic Tissue Forceps
 Pinzas atraumáticas
 Pinze atraumatiche

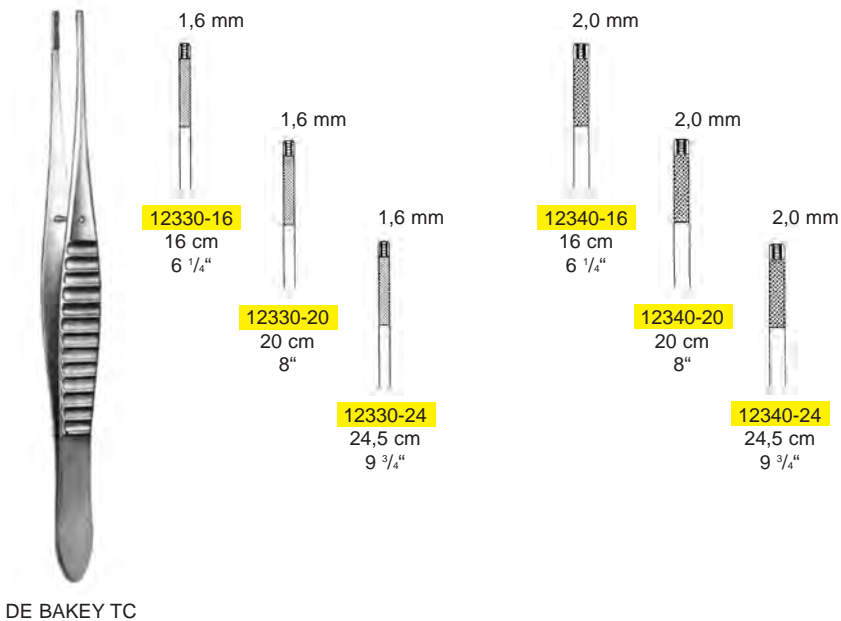
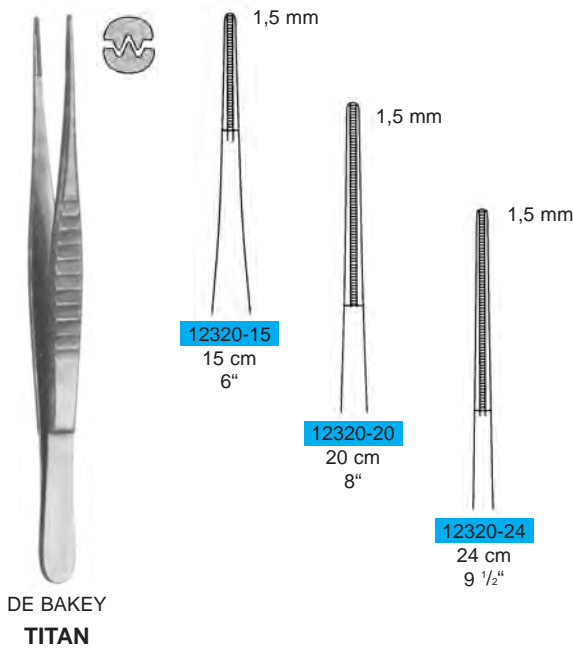

Atrauma-Bulldogklemmen
 Atrauma-Bulldog Clamps
 Clamps Atrauma Bulldog
 Pinze Atrauma Bulldog

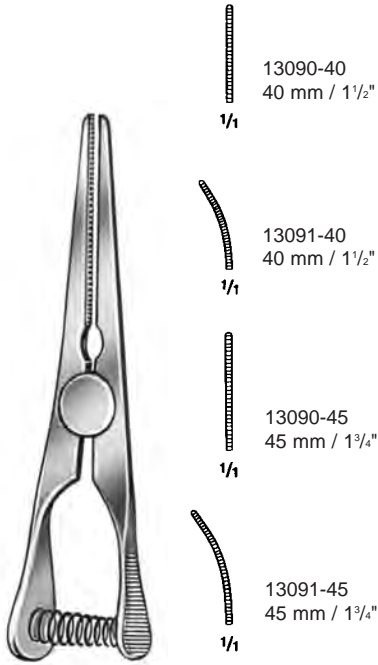

13090-40
 40 mm
 1 1/2"

13090-40
 40 mm / 1 1/2"

13091-40
 40 mm / 1 1/2"

13090-45
 45 mm / 1 3/4"

13091-45
 45 mm / 1 3/4"

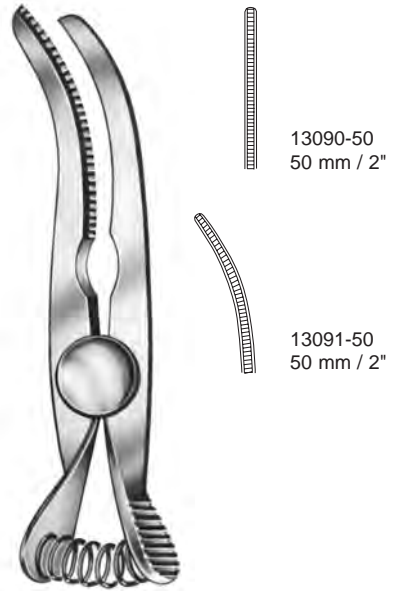

13091-50
 50 mm
 2"

13090-50
 50 mm / 2"

13091-50
 50 mm / 2"



13098-06
 57 mm
 2 3/8"

GLOVER



13099-07
 73 mm
 2 3/4"

DE BAKEY

Mini-Bulldogklemmen
 Mini Bulldog Clamps
 Clamps Bulldog Mini
 Pinze Bulldog Mini

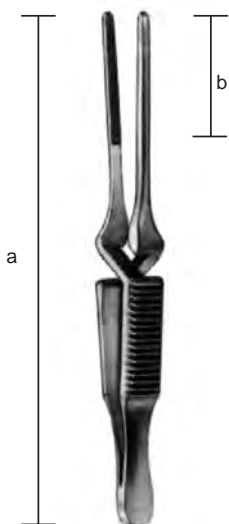

Diethrich

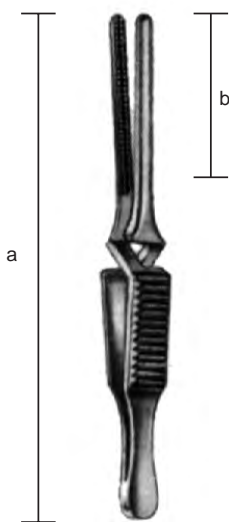
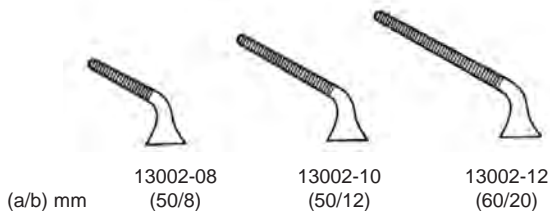
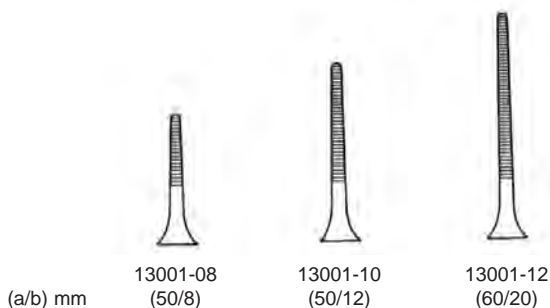

DeBaKey-Diethrich

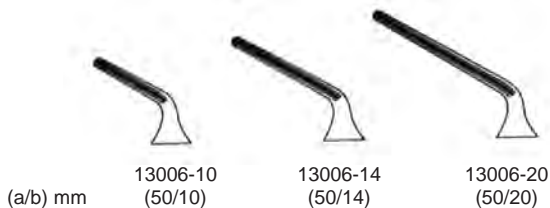
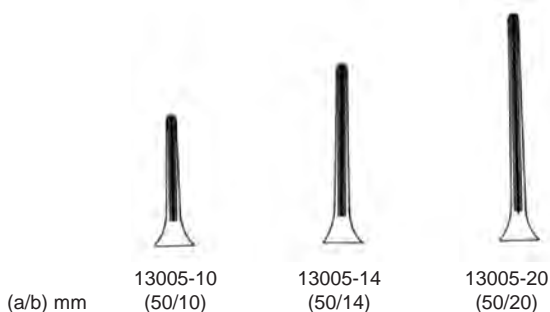

Titan-Atrauma-Bulldogklemmen
 Titanium Atrauma Bulldog Clamps
 Titan Clamp Bulldog
 Titan Pinze Bulldog

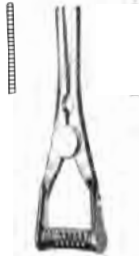

3 cm, 1.2"

Vene **13010-30**
 Arterie **13011-30**



3,5 cm, 1.4"

13010-35
13011-35



4 cm, 1 1/2"

13010-40
13011-40

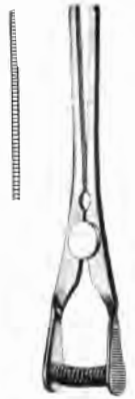

5 cm, 2"

13010-50
13011-50



3 cm, 1.2"

Vena **13012-30**
 Arteria **13013-30**



3,5 cm, 1.4"

13012-35
13013-35



4 cm, 1 1/2"

13012-40
13013-40



5 cm, 2"

13012-50
13013-50



3 cm, 1.2"

Vene **13014-30**
 Arterie **13015-30**



3,5 cm, 1.4"

13014-35
13015-35



4 cm, 1 1/2"

13014-40
13015-40

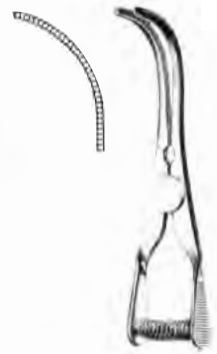

5 cm, 2"

13014-50
13015-50

Atrauma-Bulldogklemmen
 Atrauma Bulldog Clamps
 Clamps Atrauma Bulldog
 Pinze Atrauma Bulldog



DE BAKEY



13092-07
 7,5 cm
 3"



13092-08
 8,5 cm
 3.4"



13092-10
 10,5 cm
 4"



13092-12
 12 cm
 4 3/4"



13093-07
 7 cm
 2 3/4"



13093-08
 8 cm
 8 1/8"



13093-10
 10 cm
 4"



13093-12
 11,5 cm
 4 1/2"



GLOVER



13096-06
 6 cm
 2 1/4"



13096-07
 7 cm
 2 3/4"



13096-09
 9 cm
 3 1/2"



13096-11
 11 cm
 4 3/8"



13097-06
 5,5 cm
 2"



13097-07
 6,5 cm
 2 1/2"



13097-09
 8,5 cm
 3 1/4"



13097-11
 10,5 cm
 4"

Gefäßklemmen, Bulldogklemmen, Arterienklemmen
 Hemostatic Forceps
 Pinzas hemostáticas
 Pinze serraфина, Pinze emostatiche



DIEFFENBACH
 13102-04 3,5 cm, 1.4"
 13102-05 5,5 cm, 2.2"



DIEFFENBACH
 13103-04 3,5 cm, 1.4"
 13103-05 5,5 cm, 2.2"

gerade
 straight
 recta
 rette



gebogen
 curved
 curva
 curve

JOHNS-HOPKINS

13110-50	5,0 cm, 2"	13111-50
13110-55	5,5 cm, 2.2"	13111-55
13110-65	6,5 cm, 2.6"	13111-65
13110-70	7,0 cm, 2 3/4"	13111-70
13110-75	7,5 cm, 3"	13111-75
13110-90	9,0 cm, 3 1/2"	13111-90

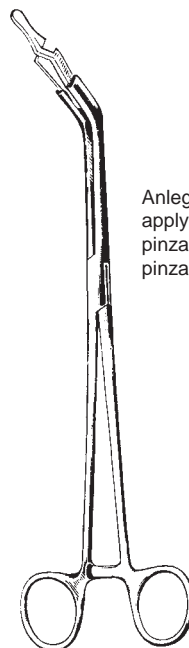

Anlegezange
 applying forceps
 pinza para poner
 pinza applicatrice

13115-00
 23 cm, 9"

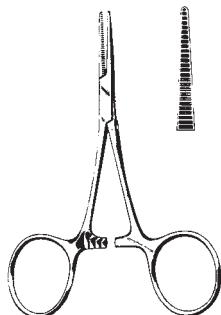

HARTMANN
 13210-10
 10 cm, 4"

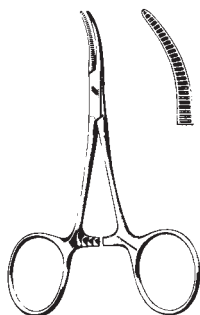

HARTMANN
 13211-10
 10 cm, 4"

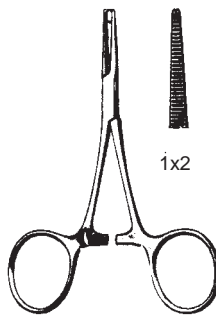

HARTMANN
 13212-10
 10 cm, 4"

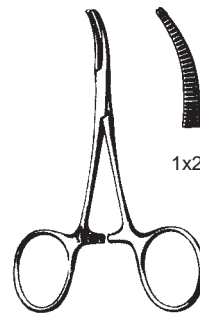

HARTMANN
 13213-10
 10 cm, 4"

Micro-HARTMANN
 13214-10
 10 cm, 4"

Micro-HARTMANN
 13215-10
 10 cm, 4"

Arterienklemmen
Hemostatic Forceps
Pinzas hemostáticas
Pinze emostatiche

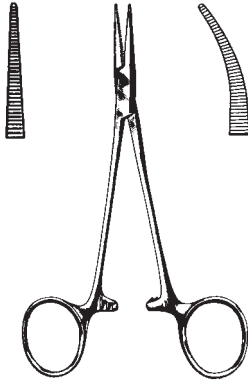

cm TITAN
12,5 5" 13224-12
14,0 5 1/2"
18,0 7"
21,0 8 1/4"

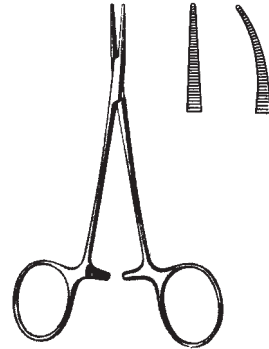

— HALSTED-MOSQUITO micro —
13222-12 12,5 cm, 5" 13223-12

TITAN — HALSTED-MOSQUITO —
13224-12 13220-12 12,5 cm, 5" 13221-12
13220-14 14,0 cm, 5 1/2" 13221-14
13220-18 18,0 cm, 7" 13221-18
13220-21 21,0 cm, 8 1/4" 13221-21

JACOBSON micro
13226-12 12,0 cm, 4 3/4" 13227-12

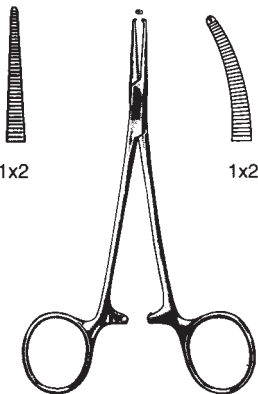

— HALSTED-MOSQUITO —
13230-12 12,5 cm, 5" 13231-12
13230-14 14,0 cm, 5 1/2" 13231-14
13230-18 18,0 cm, 7" 13231-18
13230-21 21,0 cm, 8 1/4" 13231-21

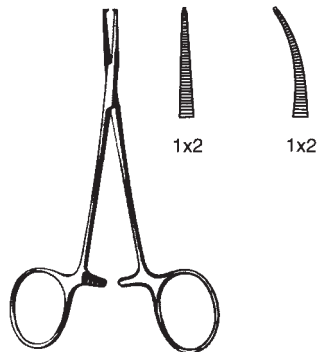

— HALSTED-MOSQUITO micro —
13232-12 13233-12

Arterienklemmen
Hemostatic Forceps
Pinzas hemostáticas
Pinze emostatiche

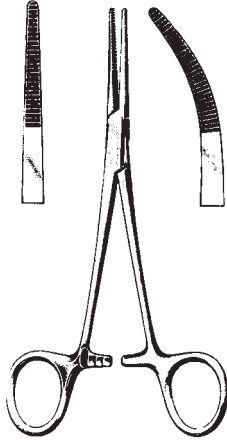

KELLY

13240-14	14 cm, 5 1/2"	13241-14
13240-18	18 cm, 7"	13241-18
13244-14	14 cm, 5 1/2"	13245-14
TITAN		TITAN

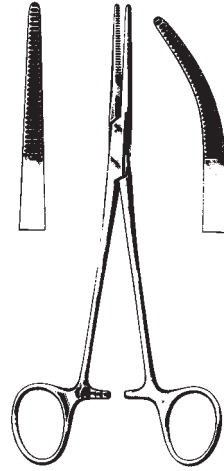

KELLY-RANKIN

13242-16	16 cm, 6 1/4"	13243-16
----------	---------------	----------

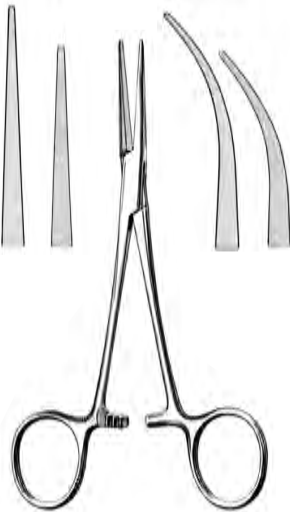

COLLER-CRILE

13256-14	14 cm, 5 1/2"	13257-14
13258-16	16 cm, 6 1/4"	13259-16

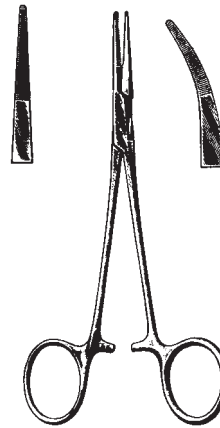

PROVIDENCE-HOSPITAL

13270-14	14 cm, 5 1/2"	13271-14
----------	---------------	----------

Arterienklemmen
Hemostatic Forceps
Pinzas hemostáticas
Pinze emostatiche

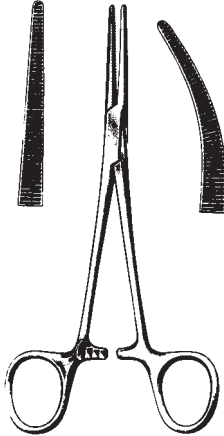

CRILE

- | | | |
|----------|---------------|----------|
| 13250-14 | 14 cm, 5 1/2" | 13251-14 |
| 13250-18 | 18 cm, 7" | 13251-18 |
| 13254-14 | 14 cm, 5 1/2" | 13255-14 |
| TITAN | | TITAN |

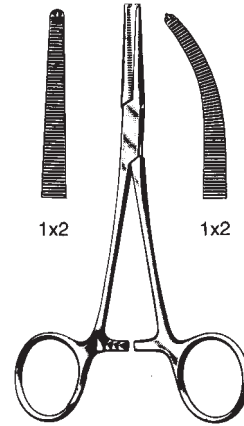

CRILE

- | | | |
|----------|---------------|----------|
| 13260-14 | 14 cm, 5 1/2" | 13261-14 |
|----------|---------------|----------|

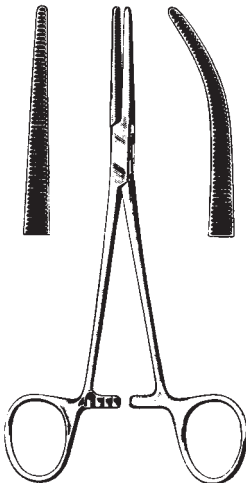

CRILE-RANKIN

- | | | |
|----------|---------------|----------|
| 13262-16 | 16 cm, 6 1/4" | 13263-16 |
|----------|---------------|----------|

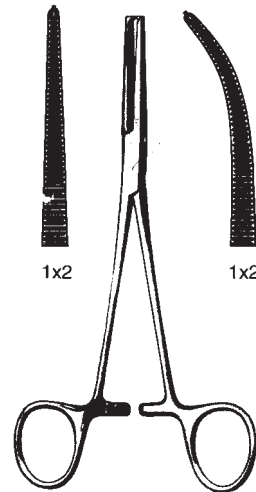

CRILE-RANKIN

- | | | |
|----------|---------------|----------|
| 13264-16 | 16 cm, 6 1/4" | 13265-16 |
|----------|---------------|----------|

Arterienklemmen
Hemostatic Forceps
Pinzas hemostáticas
Pinze emostatiche

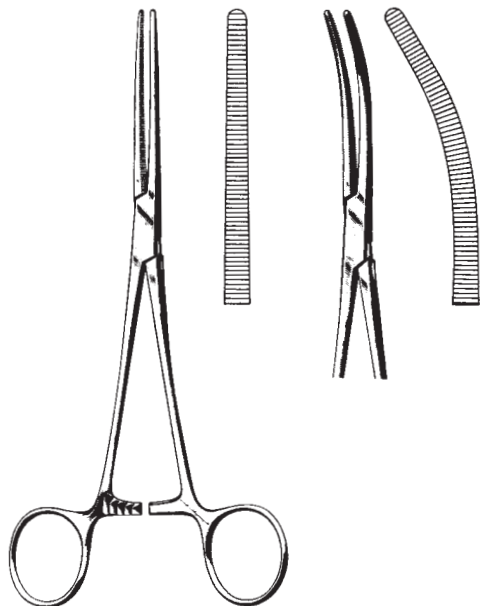

ROCHESTER-PEAN

13310-13	13 cm, 5 1/8"	13311-13
13310-14	14 cm, 5 1/2"	13311-14
13310-16	16 cm, 6 1/4"	13311-16
13310-18	18 cm, 7"	13311-18
13310-20	20 cm, 8"	13311-20
13310-22	22 cm, 8 3/4"	13311-22
13310-24	24 cm, 9 1/2"	13311-24
13310-26	26 cm, 10 1/4"	13311-26
13310-30	30 cm, 11 3/4"	13311-30

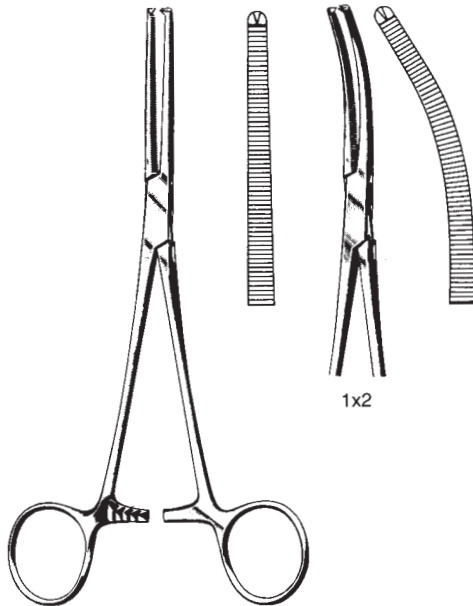

ROCHESTER-OGHSNER

13320-13	13 cm, 5 1/8"	13321-13
13320-14	14 cm, 5 1/2"	13321-14
13320-16	16 cm, 6 1/4"	13321-16
13320-18	18 cm, 7"	13321-18
13320-20	20 cm, 8"	13321-20
13320-22	22 cm, 8 3/4"	13321-22
13320-24	24 cm, 9 1/2"	13321-24
13320-26	26 cm, 10 1/4"	13321-26
13320-30	30 cm, 11 3/4"	13321-30

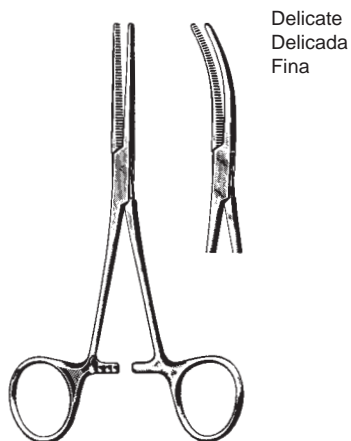

PEAN

13312-14	14 cm, 5 1/2"	13313-14
13312-16	16 cm, 6 1/4"	13313-16

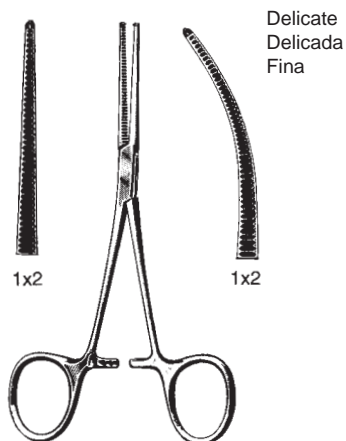

KOCHER

13322-14	14 cm, 5 1/2"	13323-14
13322-16	16 cm, 6 1/4"	13323-16

Arterienklemmen
Hemostatic Forceps
Pinzas hemostáticas
Pinze emostatiche

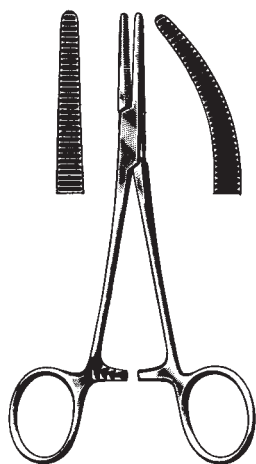

SPENCER-WELLS

13330-13	13 cm, 5"	13331-13
13330-15	15 cm, 6"	13331-15
13330-18	18 cm, 7"	13331-18
13330-20	20 cm, 8"	13331-20

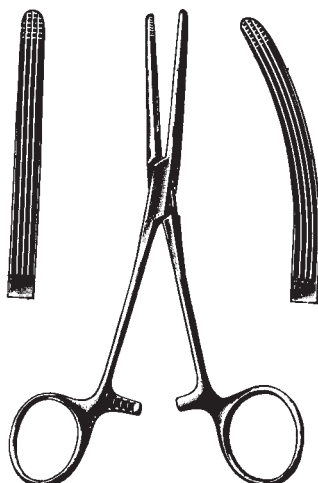

ROCHESTER-CARMALT

13340-16	16 cm, 6 1/4"	13341-16
13340-20	20 cm, 8"	13341-20

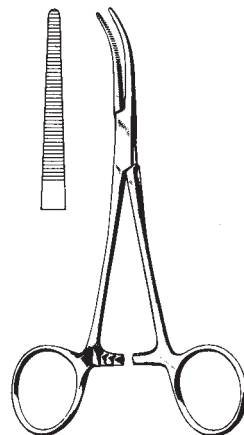

DANDY

13345-12	12 cm, 4 3/4"
13345-14	14 cm, 5 1/2"

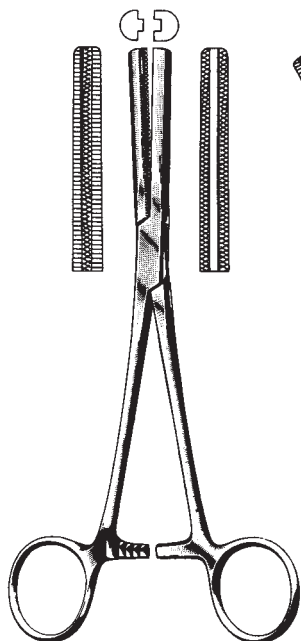

FERGUSSON

13350-16	16 cm, 6 1/4"	13351-16
13350-20	20 cm, 8"	13351-20

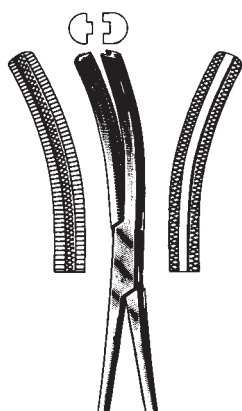

LOVELACE

13356-15	15,5 cm, 6"
----------	-------------

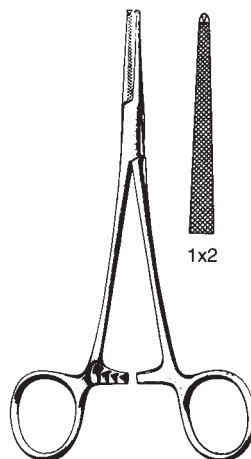

PENNINGTON

13358-15	15,5 cm, 6"
13358-20	20,0 cm, 8"

Fasszangen
Grasping Forceps
Pinza para agarrar órganos y tejidos
Pinze da presa

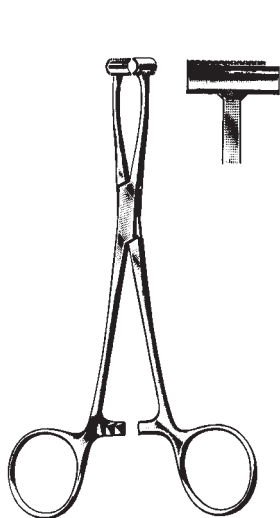

PRATT
13360-15 15 cm, 6"

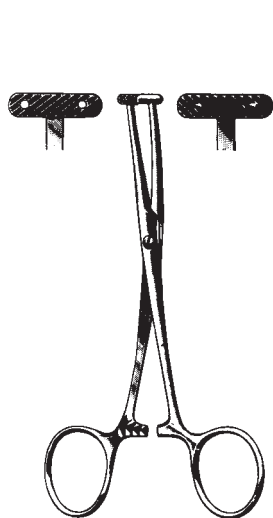

MARTEL
13364-14 14 cm, 5 1/2"

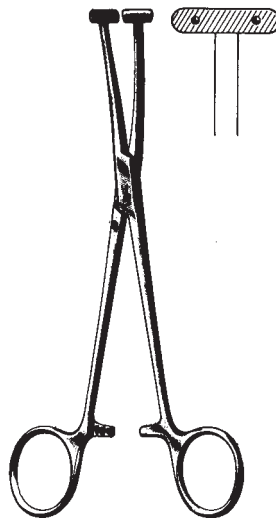

WILLET MARTEL
13366-19 19 cm, 7 1/2"

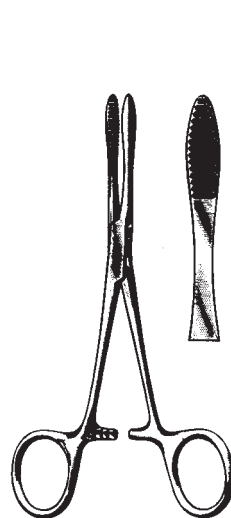

PEAN
13368-14 14 cm, 5 1/2"
13368-16 16 cm, 6 1/4"

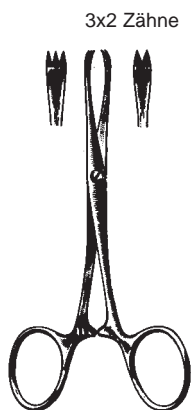

CHAPUT
13370-13
13 cm, 5 1/8"



TUFFIER
13372-13
13 cm, 5 1/8"



COLLIN
13374-14
14 cm, 5 1/2"

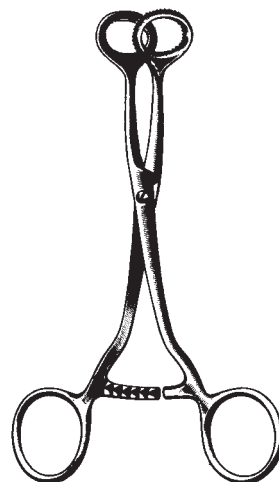

COLLIN
13376-16
16 cm, 6 1/4"

Organ- und Gewebefasszange, Arterienklemmen
 Organ- and Tissue Grasping Forceps, Hemostatic Forceps
 Pinza para agarrar órganos y tejidos, Pinzas hemostáticas
 Pinza per tessuti e organi, Pinze emostatiche



REDA
 ATRAUMA
 13377-25 - 13377-26



13377-25
 25 cm, 10"

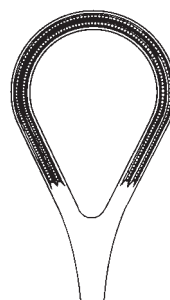

13377-26
 26 cm, 10 1/4"

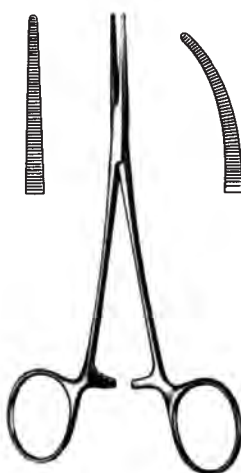

LERICHE
 13380-15 15 cm, 6" 13381-15

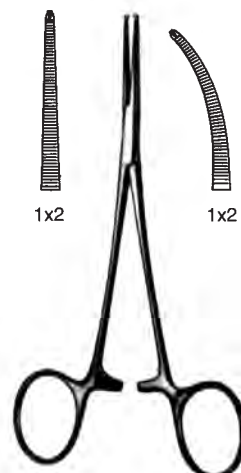

LERICHE
 13382-15 15 cm, 6" 13383-15

Arterienklemmen
 Hemostatic Forceps
 Pinzas hemostáticas
 Pinze emostatiche

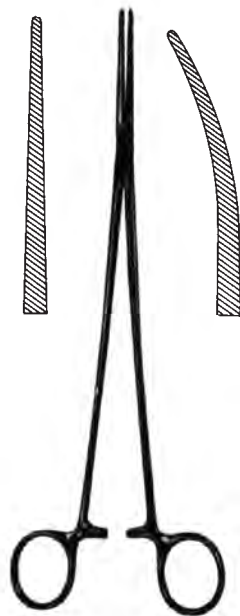

BENGOLEA
 13384-20 20 cm, 8" 13385-20
 13384-26 26 cm, 10 1/4" 13385-26

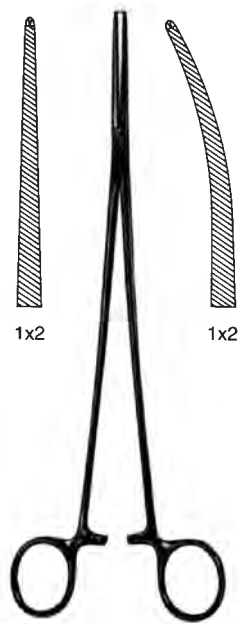

BENGOLEA
 13386-20 20 cm, 8" 13387-20
 13386-26 26 cm, 10 1/4" 13387-26

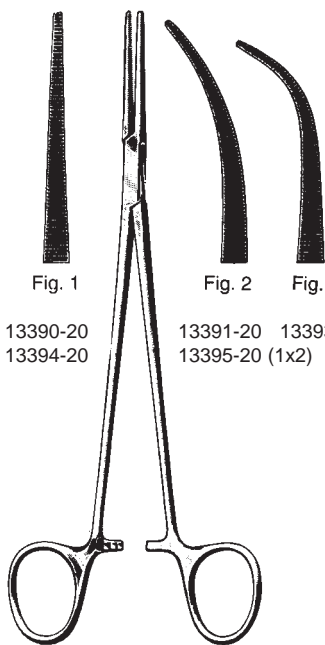
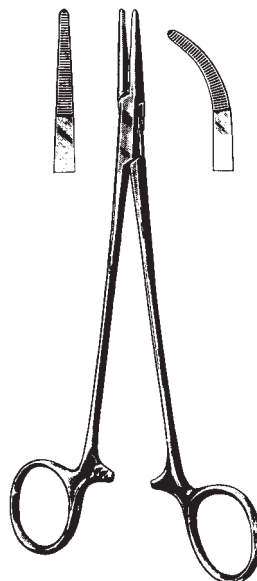

Fig. 1 Fig. 2 Fig. 3
 13390-20 13391-20 13393-20
 (1x2) 13394-20 13395-20 (1x2)

HEISS
 20 cm, 8"



ADSON
 13410-18 18,5 cm, 7 1/4" 13411-18

Arterienklemmen
 Hemostatic Forceps
 Pinzas hemostáticas
 Pinze emostatiche

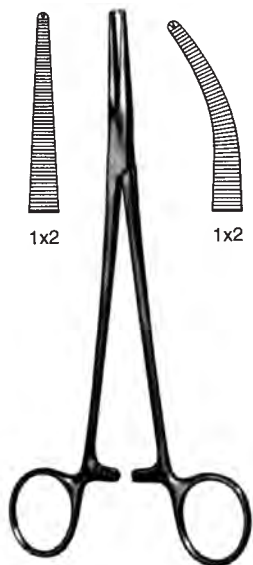

ADSON
 13412-18 18,5 cm, 7 1/4" 13413-18



Fuchsig
 13414-20 19 cm, 7 1/2"



ADSON BABY
 13415-14 14,0 cm, 5 1/2"
 13415-18 18,5 cm, 7 1/4"



NISSEN
 13416-18 18,5 cm, 7 1/4"

Arterienklemmen
 Hemostatic Forceps
 Pinzas hemostáticas
 Pinze emostatiche



OVERHOLT-BABY
 13420-14
 14 cm, 5 1/2"

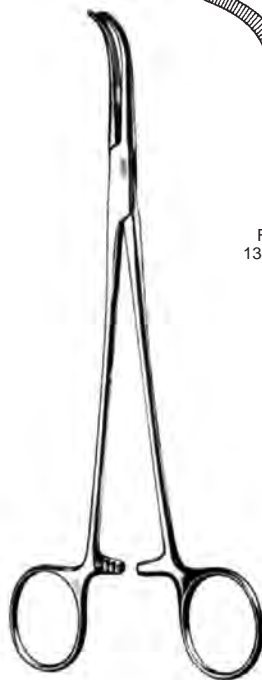

OVERHOLT-GEISSENDOERFER
 21 cm, 8 1/4"

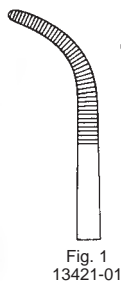

Fig. 1
 13421-01

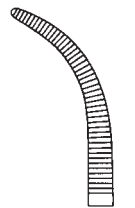

Fig. 2
 13421-02

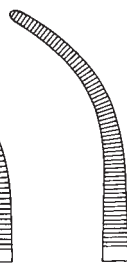

Fig. 3
 13421-03

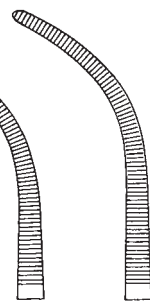

Fig. 4
 13421-04



Fig. 5
 13421-05

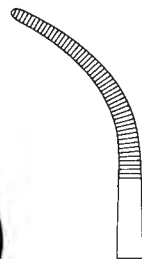

Fig. 6
 13421-06

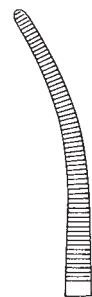

Fig. 7
 13421-07

13425-02
 26 cm
 10 1/4"

13425-03
 27 cm
 10 1/2"

13425-04
 27,5 cm
 10,8"

13425-05
 27 cm
 10 1/2"

13425-06
 28 cm
 11"



OVERHOLT



13422-00
 21,5 cm
 8 1/2"
 Fig. ①



13422-01
 21 cm
 8 1/4"
 ①



13422-02
 22 cm
 8 3/4"
 ②



13422-03
 23 cm
 9"
 ③



13422-06
 22,5 cm
 8,9"
 ⑥

Arterienklemmen
 Hemostatic Forceps
 Pinzas hemostáticas
 Pinze emostatiche



OVERHOLT-MIXTER
 13428-21
 21,5 cm, 8 1/2"



GEMINI



13431-13
 13 cm
 5 1/8"

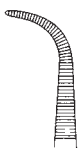

13431-16
 16 cm
 6 1/4"

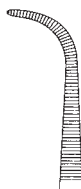

13431-18
 18 cm
 7"



13431-20
 20 cm
 8"



13431-23
 23 cm
 9"



13431-25
 25 cm
 10"



13431-28
 28 cm
 11"

Arterienklemmen
Hemostatic Forceps
Pinzas hemostáticas
Pinze emostatiche



BIRKETT

13432-19
18,5 cm
7 1/4"13433-19
18,5 cm
7 1/4"

BRIDGE

13434-28
27,5 cm
10 3/4"13435-28
27,5 cm
10 3/4"

MIXTER

13438-01
18,5 cm
7 1/4"13438-02
21 cm
8 1/4"13438-03
21,5 cm
8 1/2"13438-04
22 cm
8 3/4"

Arterienklemmen
Hemostatic Forceps
Pinzas hemostáticas
Pinze emostatiche



RUMEL
23 cm, 9"

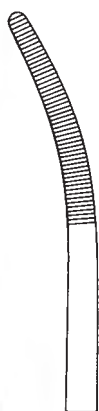

13441-01

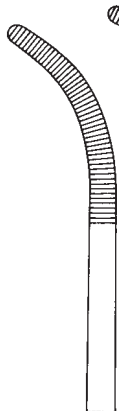

13441-02



13441-03

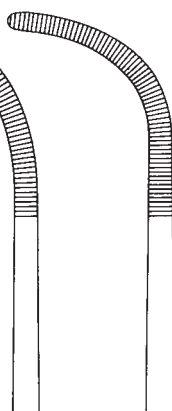

13441-04



WIKSTROEM
13447-20
20,5 cm, 8"



13442-21 21 cm, 8 1/4"
13442-26 26 cm, 10 1/4"



21 cm, 8 1/4" 13443-21
26 cm, 10 1/4" 13443-26



13444-21 21 cm, 8 1/4"
13444-26 26 cm, 10 1/4"

1x2

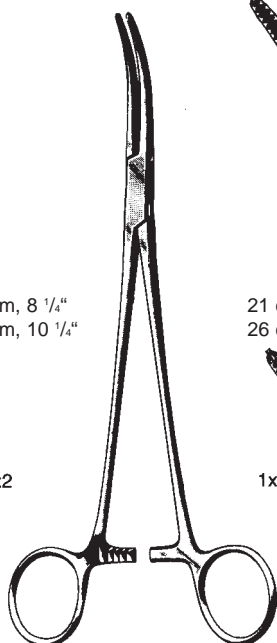

TOENNIS

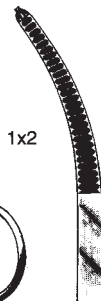

1x2

21 cm, 8 1/4" 13445-21
26 cm, 10 1/4" 13445-26

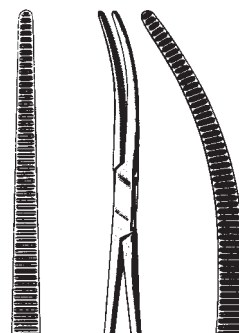

13448-22 22 cm, 8 3/4" 13449-22

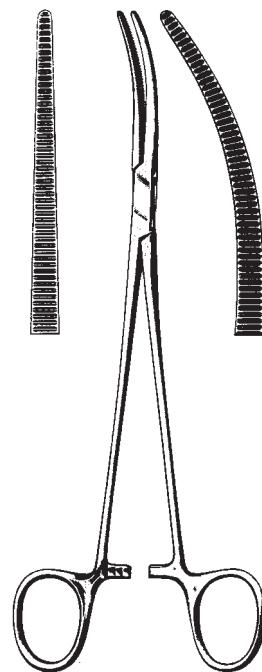

ROBERTS

Arterienklemmen
 Hemostatic Forceps
 Pinzas hemostáticas
 Pinze emostatiche



CRAFOORD
 13453-18 18 cm, 7"
 13453-24 24 cm, 9 1/2"



SAROT
 13450-24 24 cm, 9 1/2" 13451-24



ZENKER
 29,5 cm, 11 1/2"

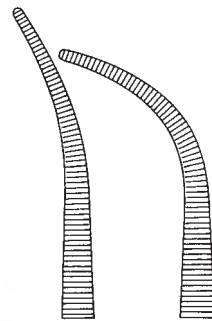

13455-01 13455-02

Arterienklemmen
Hemostatic Forceps
Pinzas hemostáticas
Pinze emostatiche

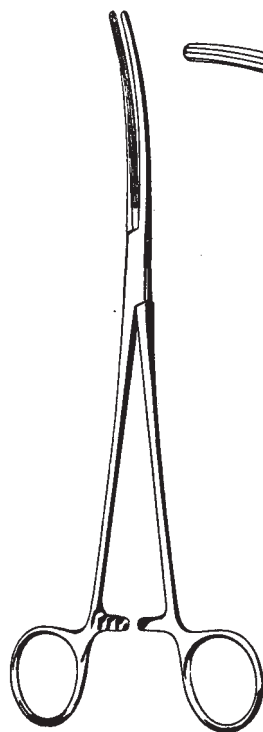

CRAFOORD-SELLORS
24 cm, 9 1/2"

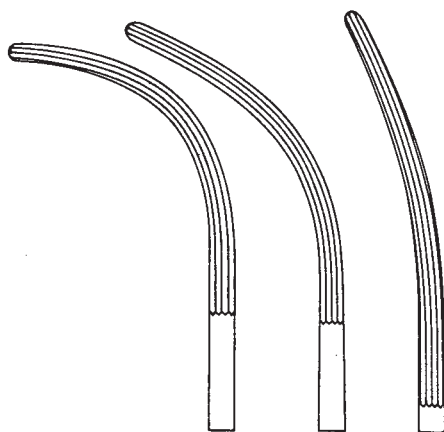

13456-01 13456-02 13456-03



LAWRENCE
13457-28 28 cm, 11"



MEEKER
13459-18 18 cm, 7"
13459-28 28 cm, 11"

Arterienklemmen
Hemostatic Forceps
Pinzas hemostáticas
Pinze emostatiche



MIXTER

13471-14 14 cm, 5 1/2"
13471-16 16 cm, 6 1/4"
13471-18 18 cm, 7"
13471-23 23 cm, 9"

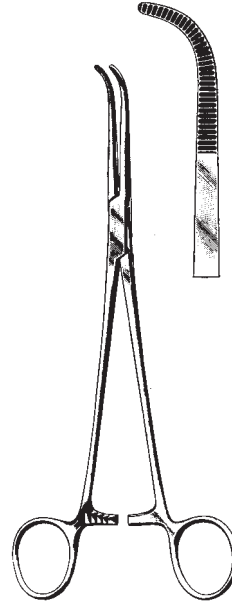

MIXTER

13473-22
22 cm, 8 3/4"



KANTROWITZ

13474-19 19 cm, 7 1/2"
13474-24 24 cm, 9 1/2"
13474-26 26 cm, 10 1/4"

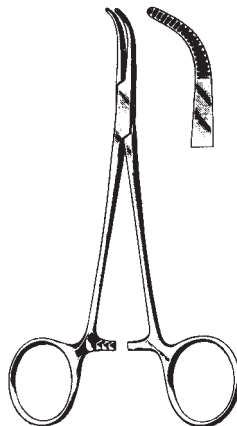

MIXTER BABY

13475-14
14 cm, 5 1/2"



MIXTER BABY

13475-18
18 cm, 7"

Arterienklemmen
Hemostatic Forceps
Pinzas hemostáticas
Pinze emostatiche



MIXTER-O'SHAUGNESSY
13477-15 15,5 cm, 6"
13477-19 19,0 cm, 7 1/2"

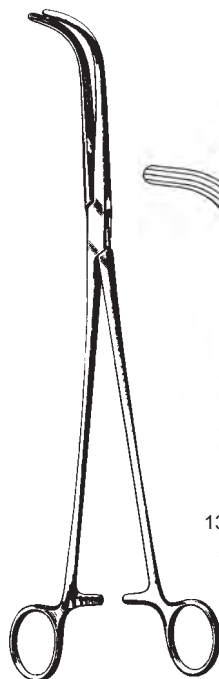

13479-22 22 cm 8 3/4"
13479-25 25 cm 10"
13479-28 28 cm 11"

MIXTER

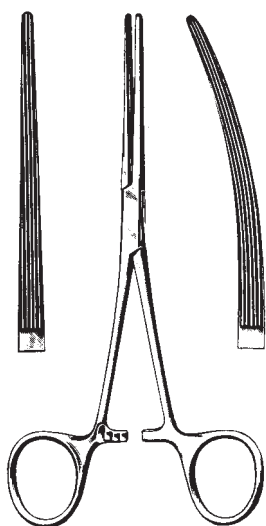

BAINBRIDGE
13480-15 15,0 cm, 6" 13481-15
13480-18 18,5 cm, 7 1/4" 13481-18

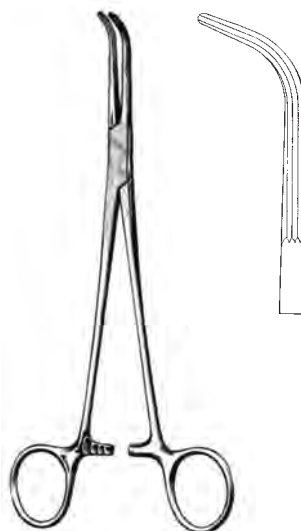

LAHEY
13491-19 19 cm, 7 1/2"

Arterienklemmen
Hemostatic Forceps
Pinzas hemostáticas
Pinze emostatiche

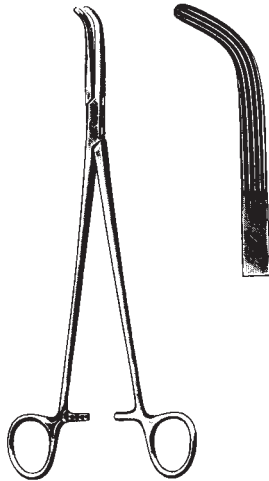

LAHEY
13493-23 23 cm, 9"

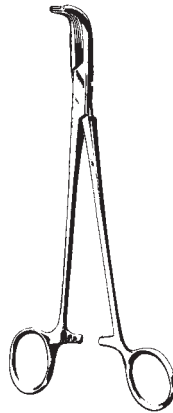

LOWER
13495-18 18 cm, 7"

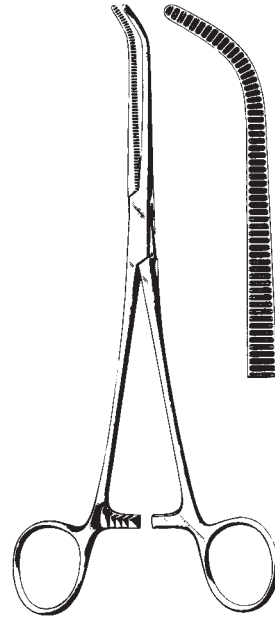

JOHNS-HOPKINS
13497-20 20 cm, 8"

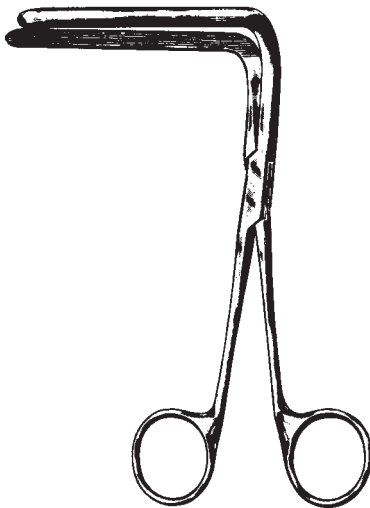

MIXTER
13499-16
16,5 cm, 6 1/2"

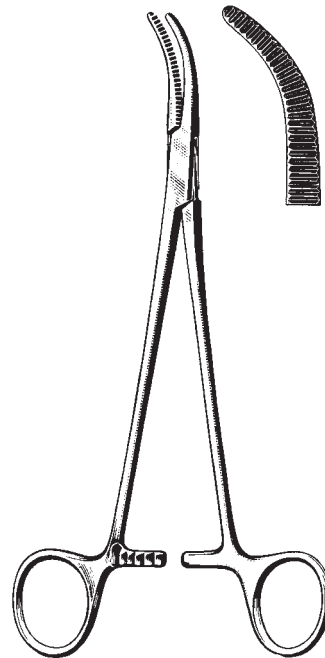

MOYNIHAN
13501-23
23 cm, 9"

Arterienklemmen
 Hemostatic Forceps
 Pinzas hemostáticas
 Pinze emostatiche

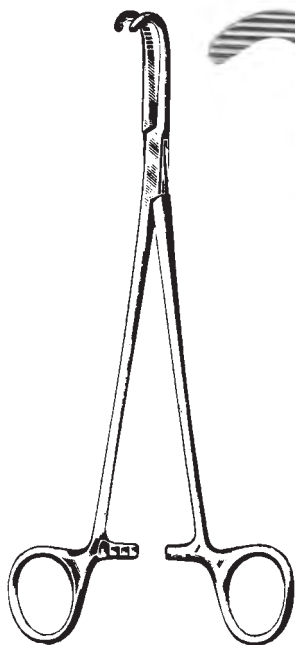

DESJARDINS
 13503-21 21 cm, 8 1/4"

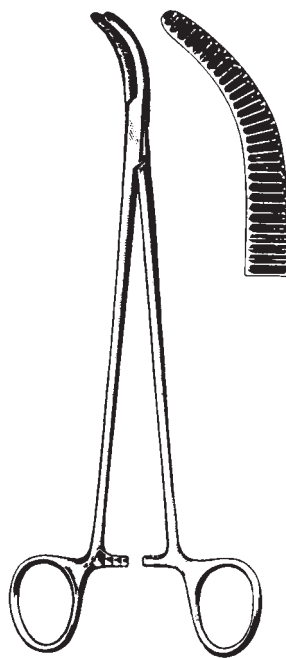

DESJARDINS
 13505-21 21 cm, 8 1/4"

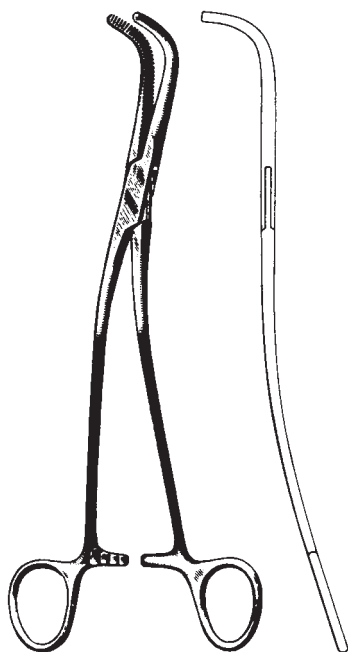

GRAY

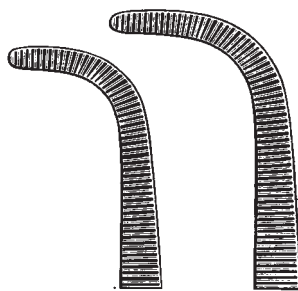

13507-22
 22 cm
 8 3/4"

13507-23
 23 cm
 9"

Arterienklemmen
 Hemostatic Forceps
 Pinzas hemostáticas
 Pinze emostatiche

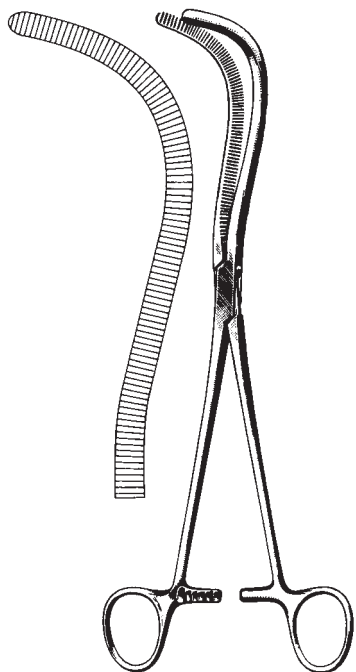

MAYO-GUYON
 13513-23
 23 cm, 9"

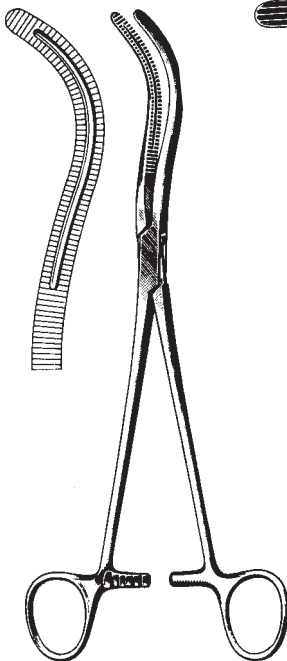

STILLE
 13515-23
 23 cm, 9"



GUYON
 13517-23
 23 cm, 9"

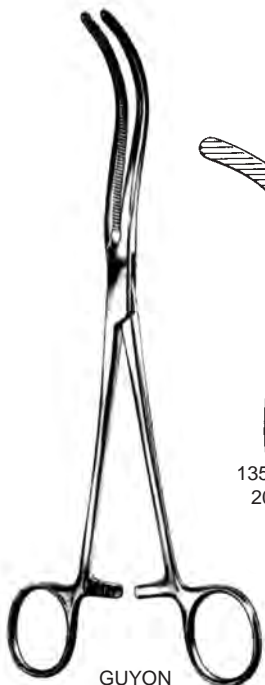

GUYON

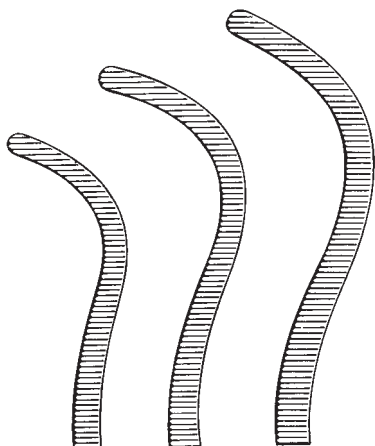

13519-20 20 cm 8"
 13519-22 22 cm 8 3/4"
 13519-24 24 cm 9 1/2"



GUYON



13520-23
 23 cm
 9"

13520-24
 24 cm
 9 1/2"

ATRAUMA

Hysterektomieklemmen
 Hysterectomy Forceps
 Pinzas para histerectomía
 Pinze per isterectomia

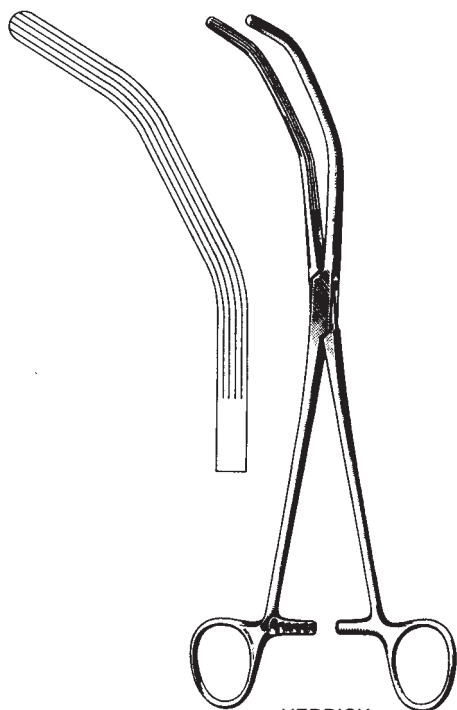

HERRICK
 13523-23
 23 cm, 9"

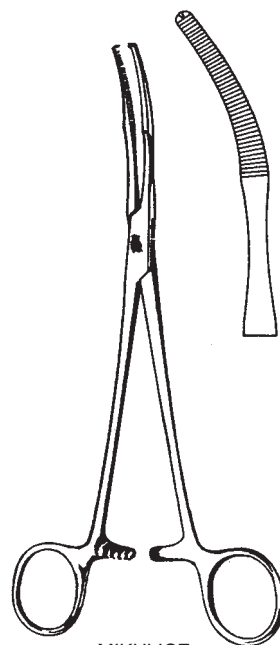

MIKULICZ
 13551-14 14 cm, 5 1/2" BABY
 13551-18 18 cm, 7"
 13551-20 20 cm, 8"

Peritoneum-Klemme
 Peritoneum Forceps
 Pinzas para peritoneo
 Pinze peritoneali

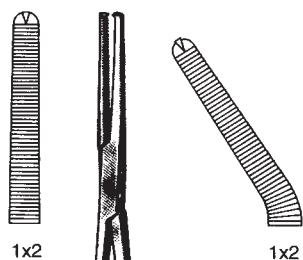

1x2

1x2

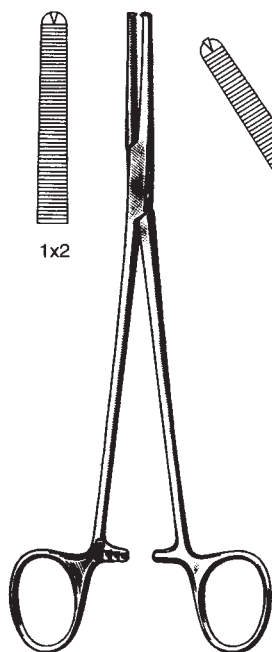

PHANEUF

13554-21 21 cm, 8 1/4" 13555-21



MIKULICZ

13556-24 24 cm, 9 1/2"

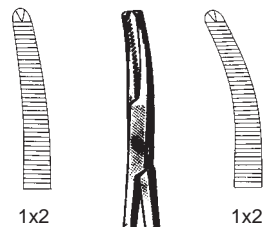

1x2

1x2

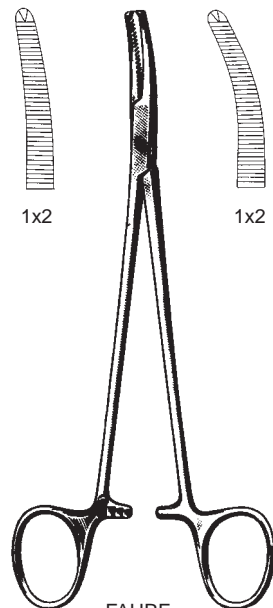

FAURE

13561-20 20 cm, 8" 13563-20

Hysterektomieklemmen
 Hysterectomy Forceps
 Pinzas para histerectomía
 Pinze per isterectomia



WERTHEIM
 13570-23
 23,5 cm, 9 1/4"

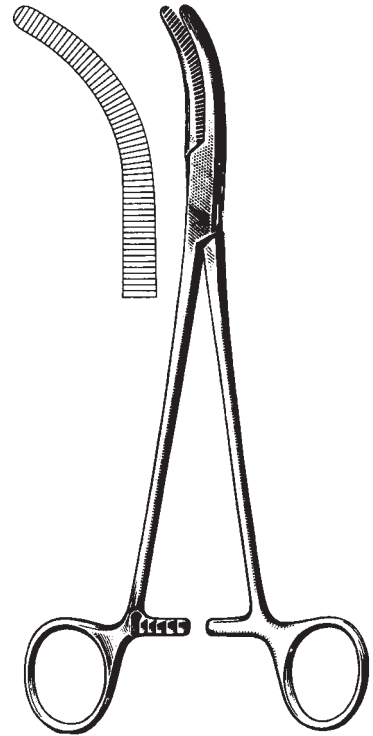

WERTHEIM
 13571-25
 25 cm, 10"

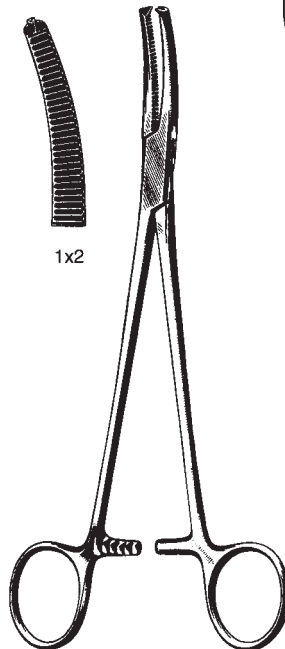

WERTHEIM
 13573-22 22 cm, 8 3/4"

Hysterektomieklemmen
Hysterectomy Forceps
Pinzas para histerectomía
Pinze per isterectomia



SEGOND-LANDAU
13574-24
24 cm, 9 1/2"



SEGOND
13575-24
24 cm, 9 1/2"

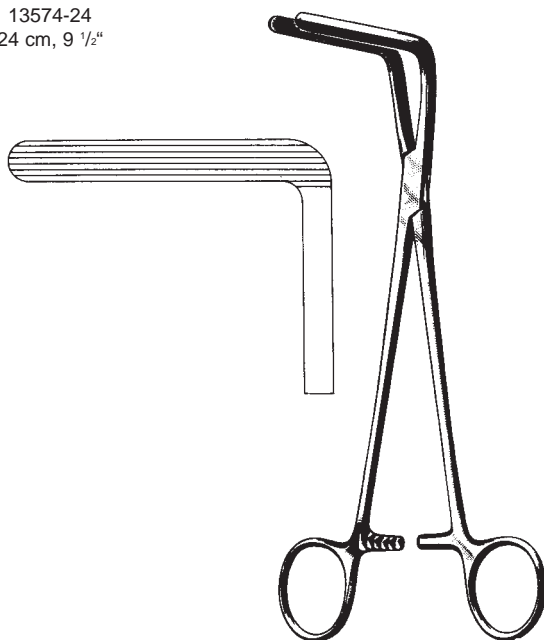

WERTHEIM-CULLEN
13579-21 21,5 cm, 8 1/2"

Hysterektomieklemmen
 Hysterectomy Forceps
 Pinzas para histerectomía
 Pinze per isterectomia



13580-80
 80 mm, 3"
 Maul/Morso/Boca



13580-60
 60 mm, 2 1/4"
 Maul/Morso/Boca



23 cm, 9"



13591-20

13593-20



HEANEY
 20 cm, 8"

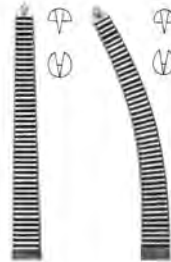

HOLZBACH
 13598-24 24 cm, 9 1/2" 13599-24

Hysterektomieklemmen
 Hysterectomy Forceps
 Pinzas para histerectomía
 Pinze per isterectomia

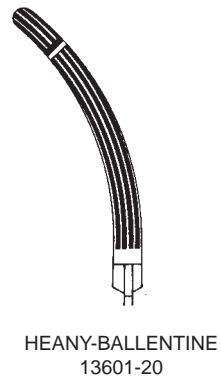
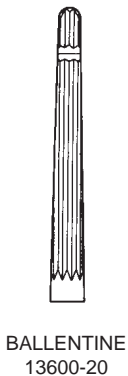
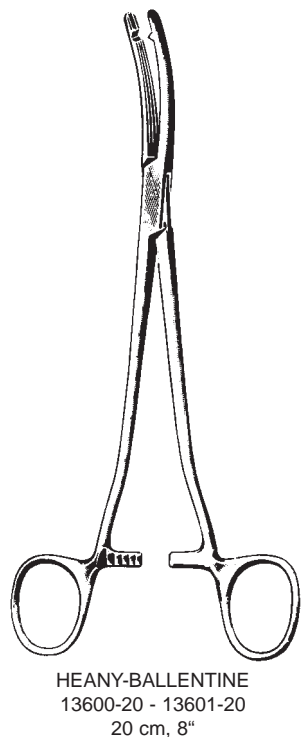
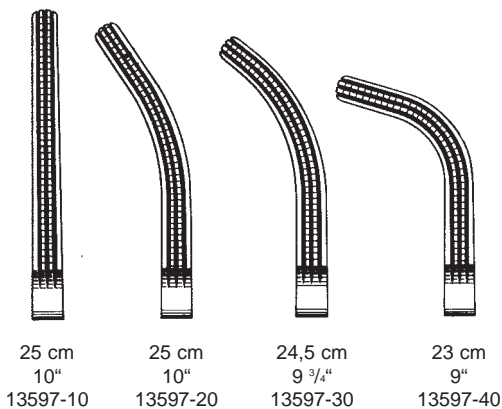
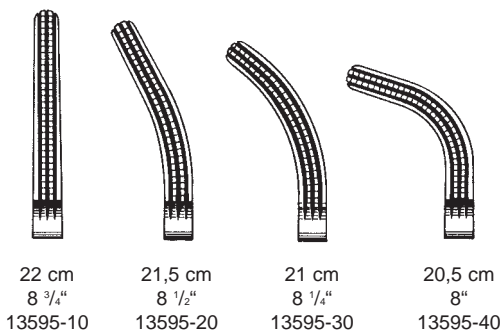

Hysterektomieklemmen
Hysterectomy Forceps
Pinzas para histerectomía
Pinze per isterectomia



WERTHEIM
13605-26
25,5 cm, 10"

Schlauchklemmen
 Tubing Clamps
 Pinzas cierra-tubos
 Pinze serratubi



KLINIKUM BERLIN
 13702-14
 14,5 cm, 5 3/4"



13710-15
 15 cm, 6"



13710-18
 18 cm, 7"



13710-20
 20 cm, 8"



PRESBYTERIAN
 13704-16 16 cm, 6 1/4"
 13704-18 18 cm, 7"



13712-15
 15 cm, 6"



13712-18
 18 cm, 7"



13712-20
 20 cm, 8"

Schlauchklemme
Tubing clamps
Pinzas cierra-tubos
Pinze serratubi a rulli

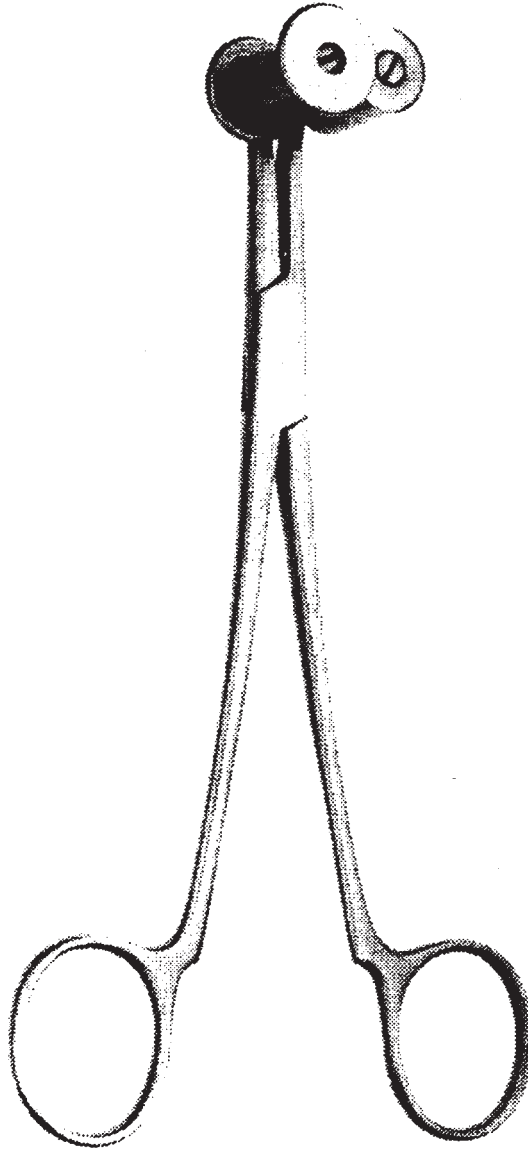

BÜLOW-GUNAR-HEY
13720-18 18 cm, 7"

Tuchklemmen
Towel Forceps
Pinzas de campos
Pinze fissateli



SCHAEDDEL
15101-09
9 cm, 3 1/2"



JONES
15103-07
7 cm, 2 3/4"
15103-09
9 cm, 3 1/2"

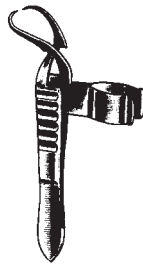

JONES-CLIP
15105-09
9 cm, 3 1/2"

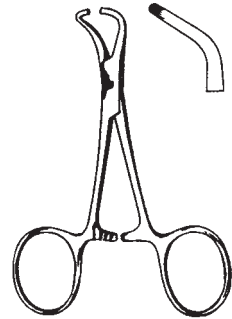

TOHUKU
15107-10 10 cm, 4"
15107-13 13 cm, 5 1/8"

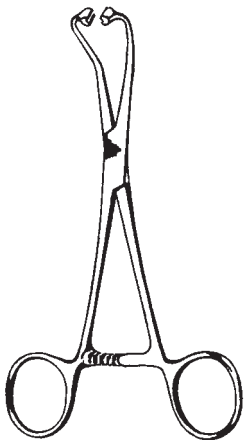

PEERS
15108-14
14,5 cm, 5 3/4"

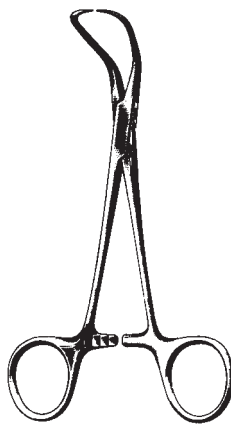

BACKHAUS
15111-09 9 cm, 3 1/2"
15111-11 11 cm, 4 3/8"
15111-13 13 cm, 5 1/8"
15111-15 15 cm, 6"



BACKHAUS-CLIP
15115-11
11 cm, 4 3/8"

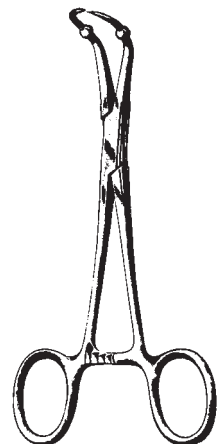

ROEDER
15117-13
13 cm, 5 1/8"

Tuchklemmen
Towel Forceps
Pinzas de campos
Pinze fissateli

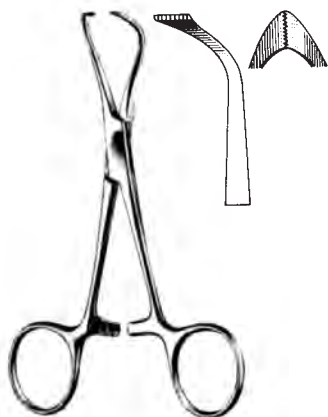

LORNA
15121-11 11 cm, 4 $\frac{3}{8}$ "
15121-13 13 cm, 5 $\frac{1}{8}$ "



BALL AND SOCKET
15123-11 11 cm, 4 $\frac{3}{8}$ "
15123-13 13 cm, 5 $\frac{1}{8}$ "



15125-14
14,5 cm, 5 $\frac{3}{4}$ "

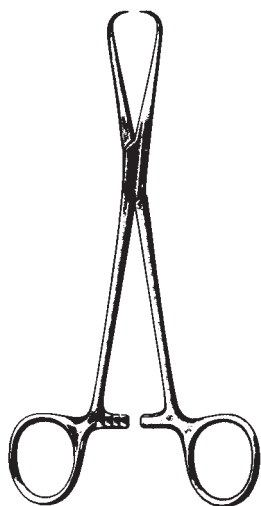

BERNHARD
15140-16
16,5 cm, 6 $\frac{1}{2}$ "

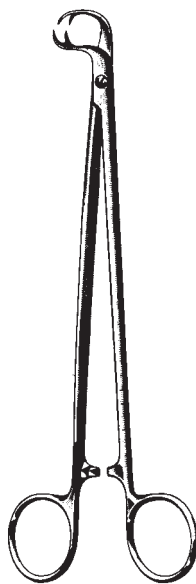

MOYNIHAN
15150-19
19 cm, 7 $\frac{1}{2}$ "



DOYEN
15161-18
18 cm, 7"

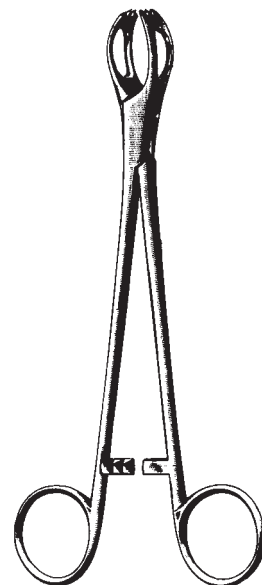

LANE
15164-15 15 cm, 6"
15164-20 20 cm, 8"

Tupferzangen
 Dressing Forceps
 Pinzas porta-esponjas
 Pinze per medicatura

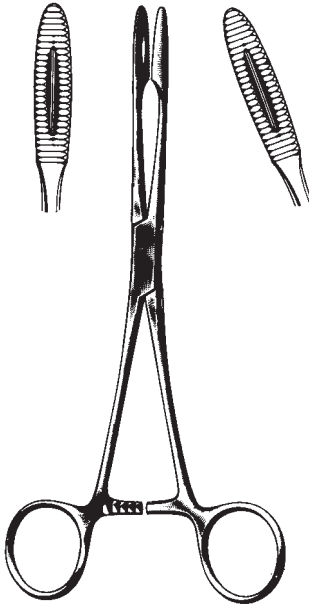

GROSS-MAIER
 17110-20 20 cm, 8" 17111-20
 17110-25 25 cm, 10" 17111-25

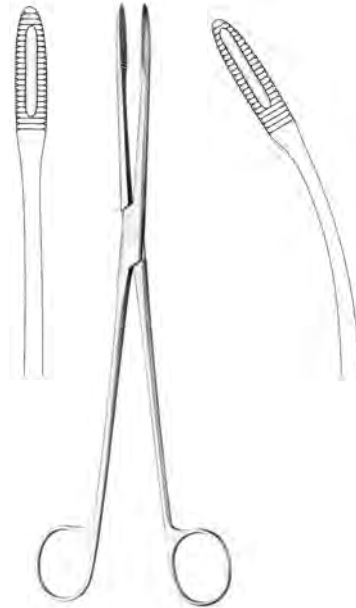

GROSS-MAIER
 17112-20 20 cm, 8" 17113-20
 17112-25 25 cm, 10" 17113-25

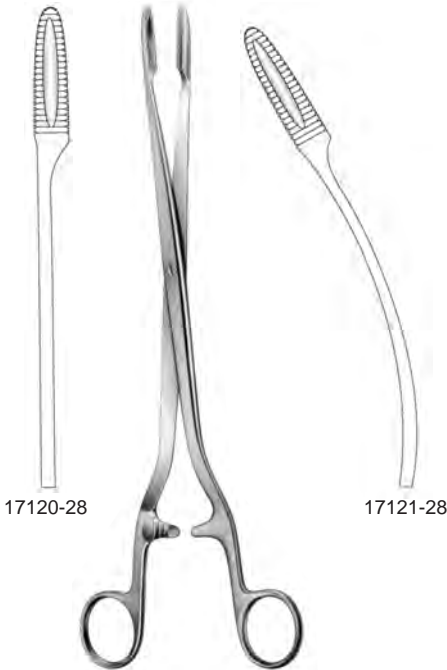

17120-28

17121-28

SIMS-MAIER
 28 cm, 11"



DUPLAY KORNZANGE
 17131-21 21 cm, 8 1/4"

Tupferzangen
Dressing Forceps
Pinzas porta-esponjas
Pinze per medicatura



KORNZANGE
17133-17 17 cm, 6 3/4"

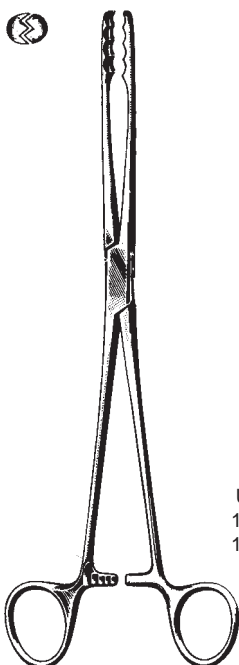

ULRICH
17160-22
17160-25



22 cm, 8 3/4"
25 cm, 10"

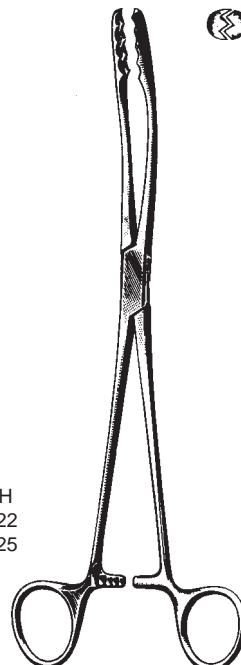

ULRICH
17161-22
17161-25

Tupferzange
 Sponge Holding Forceps
 Pinzas porta esponjas
 Pinze ad anelli per tamponi e spugne

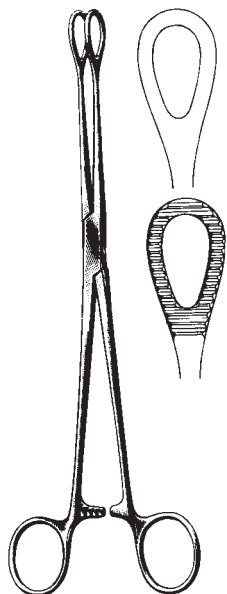

FOERSTER

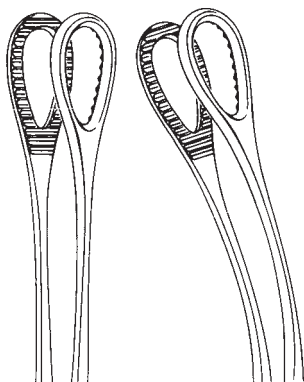

17170-18
 17170-20
 17170-25



17171-18 18 cm, 7"
 17171-20 20 cm, 8"
 17171-25 25 cm, 10"

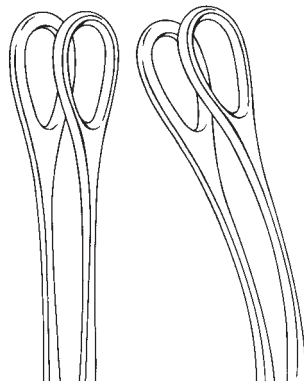

17172-18
 17172-25
 17173-18
 17173-25

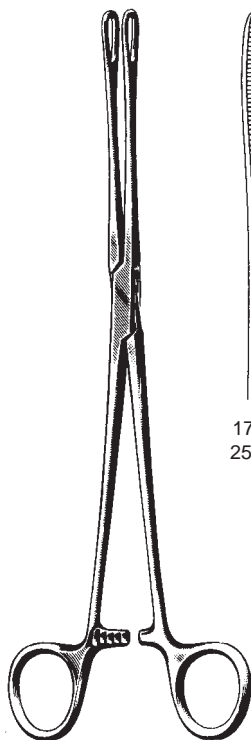

FOERSTER



17174-25
 25 cm, 10"

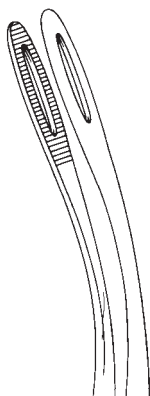

17175-25
 25 cm, 10"



17180-18
 18 cm, 7"



17180-25
 25 cm, 10"

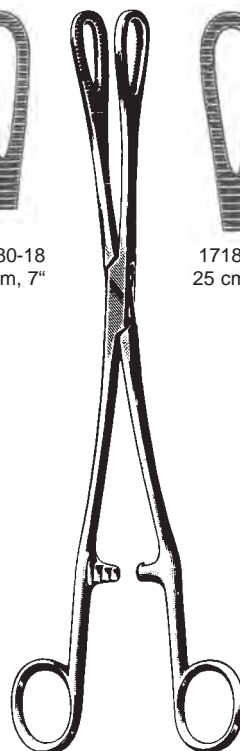

RAMPLEY

Tupferzangen
Dressing Forceps
Pinzas porta-esponjas
Pinze per tamponi

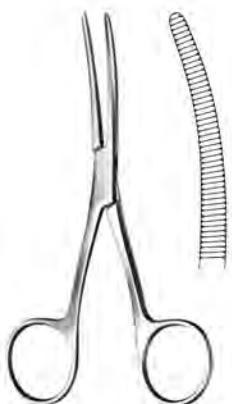

BRYANT
17207-13
13 cm, 5 1/8"



LISTER (Sinus)
17210-13 13 cm, 5 1/8"
17210-16 16 cm, 6 1/4"
17210-18 18 cm, 7"

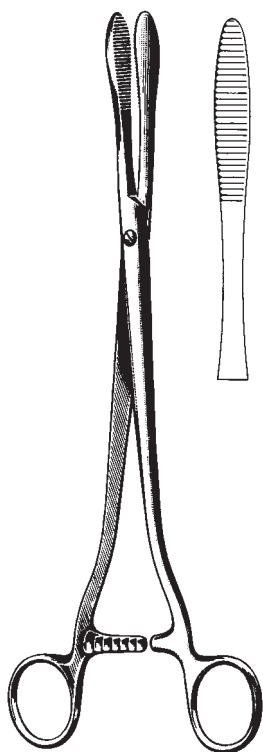

COLLIN
17220-25 25 cm, 10"



17227-25

PELKMANN
17226-25 25 cm, 10"



CHERON
17229-25 25 cm, 10"

Tamponzangen
 Dressing Forceps
 Pinzas para tapones
 Pinze per tamponi

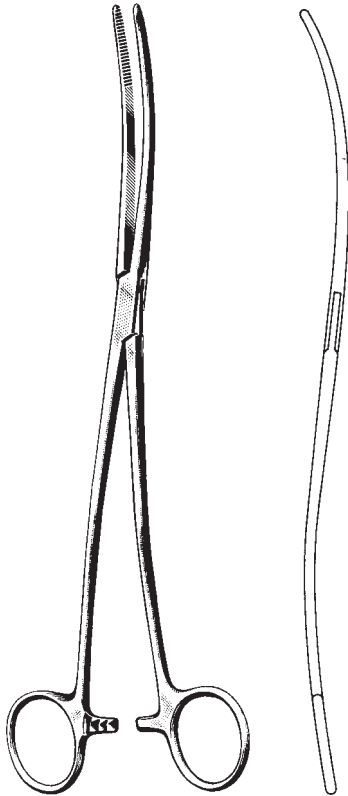

— BOZEMANN —
 17230-26 17231-26
 26 cm, 10 1/4"

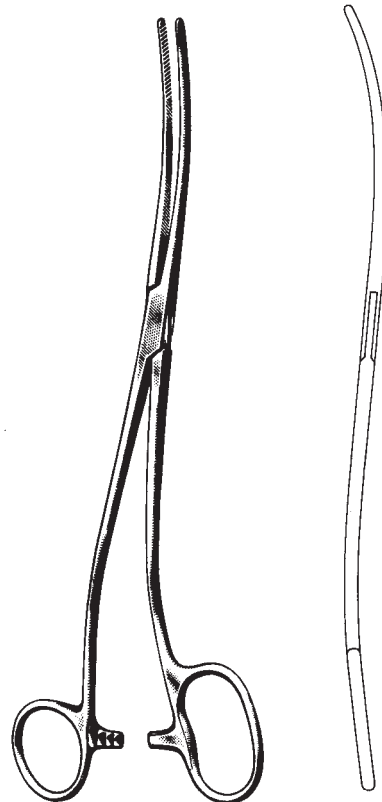

BOZEMANN-DOUGLAS
 17233-26
 26 cm, 10 1/4"

Wundhaken
Retractors
Separadores
Divaricatori

* Satz, set, juego, serie

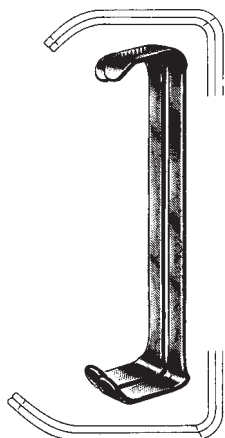

* FARABEU
19102-12
12 cm, 4 3/4"

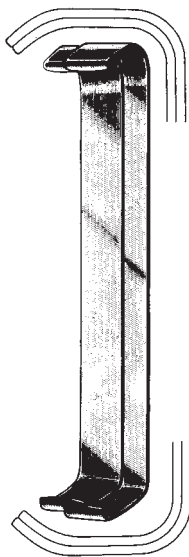

* FARABEU
19102-15
15 cm, 6"



COLLIN
19104-15
15 cm, 6"

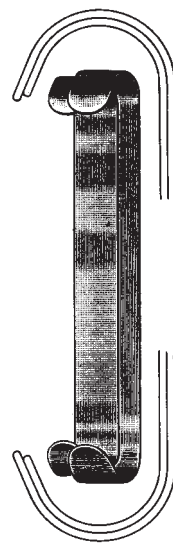

* PARKER
19110-13
13,5 cm, 5 1/4"

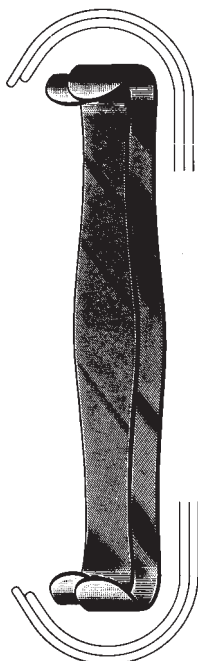

* PARKER
19110-18 18 cm, 7"

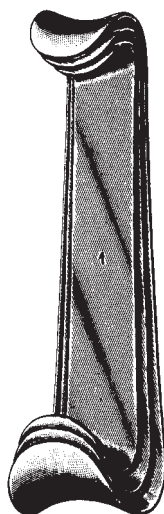

* ROUX
19120-00

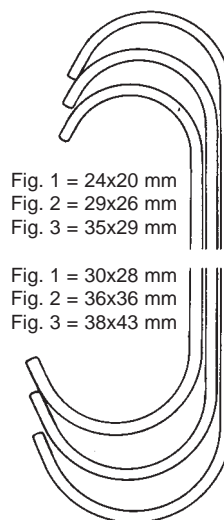

Fig. 1 = 24x20 mm
Fig. 2 = 29x26 mm
Fig. 3 = 35x29 mm

Fig. 1 = 30x28 mm
Fig. 2 = 36x36 mm
Fig. 3 = 38x43 mm

19120-14 Fig. 1 14 cm, 5 1/2"
19120-15 Fig. 2 15 cm, 6"
19120-17 Fig. 3 17 cm, 6 3/4"

Wundhaken
Retractors
Separadores
Divaricatori



ROUX BABY
19122-13
13 cm, 5 1/8"



LUER
19123-11
11 cm, 4 3/8"

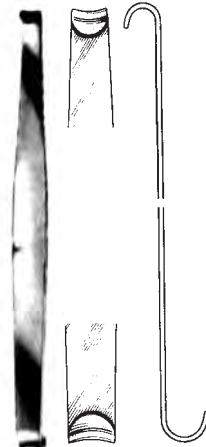

ROUX mini
19124-15
14 cm, 5 1/2"



RAGNELL
19125-14
14 cm, 5 1/2"



ROSE
19126-13
13 cm, 5 1/8"



CRILE
19127-11
11,5 cm, 4 1/2"

Wundhaken
Retractors
Separadores
Divaricatori

Fig. 2 = 25x24 mm
Fig. 1 = 21x24 mm

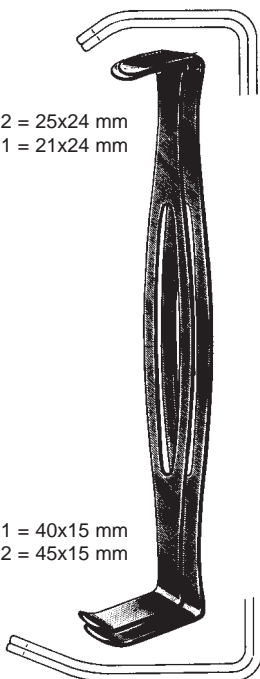

Fig. 1 = 40x15 mm
Fig. 2 = 45x15 mm

* US ARMY / Parker-Langenbeck
19131-21 21 cm, 8 1/4"



MAYO-COLLINS
19132-15
15 cm, 6"

Fig. 2 = 47x13 mm
Fig. 1 = 42x13 mm

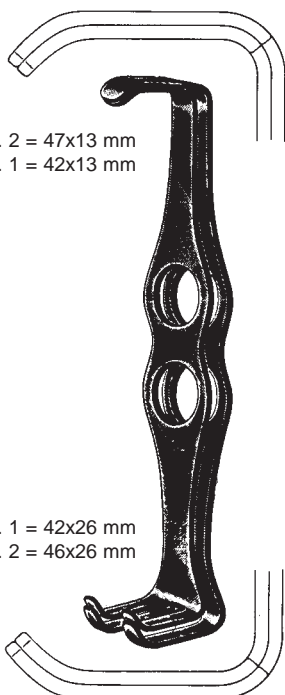

Fig. 1 = 42x26 mm
Fig. 2 = 46x26 mm

* MATHIEU
19134-20 20 cm, 8"

37x40 mm



30 x 31 mm

GOELET
19135-19 19 cm, 7 1/2"

52x33 mm

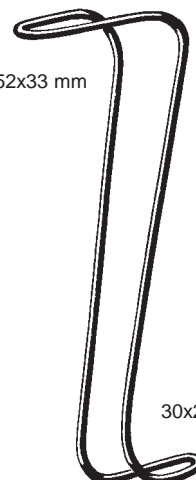

30x21 mm

COLLIN-HARTMANN
19137-16 16 cm, 6 1/4"

Wundhaken
Retractors
Separadores
Divaricatori

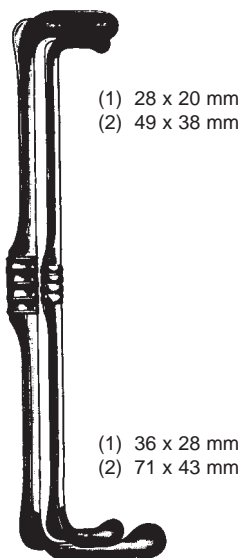

RICHARDSON-EASTMAN
(Set) 19140-00
(1) 19140-01 26 cm, 10 1/4"
(2) 19140-02 28 cm, 11"

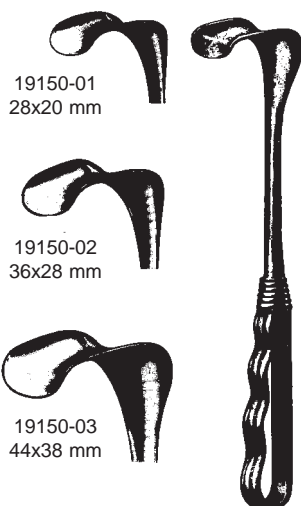

RICHARDSON
24 cm, 9 1/2"



RICHARDSON
19150-04
24 cm, 9 1/2"

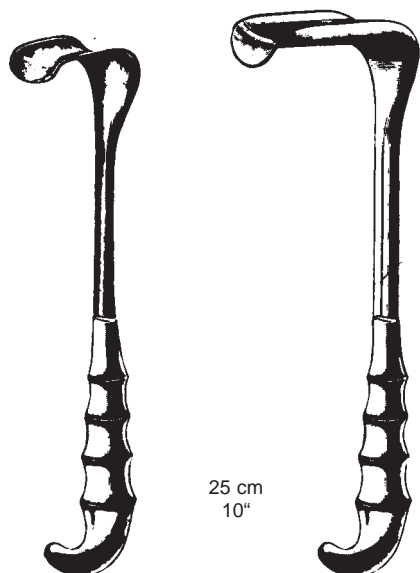

RICHARDSON GRIP
19152-25 20x25 mm
19152-31 25x31 mm
19152-38 38x38 mm
19152-51 19x51 mm
19152-64 41x64 mm

25 cm
10"

KELLY GRIP
19158-51 38x51 mm
19158-64 51x64 mm
19158-76 64x76 mm
19158-82 70x82 mm



KELLY
26 cm, 10 1/4"

Wundhaken, Bauch- und Darmspatel
 Retractors, abdominal and intestinal spatula
 Separadores, espátula intestinal y abdominal
 Divaricatori, spatole addominali e intestinali

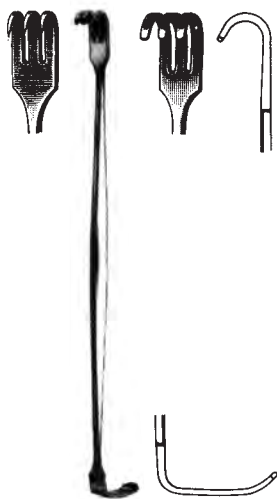

SENN-MILLER

19160-17 17 cm, 6 3/4" 19161-17

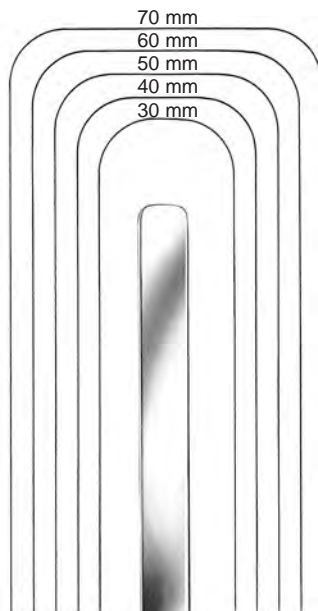

biegsam
 malleable
 maleable
 malleabili

biegsam, malleable, maleable, malleabili



RIBBON

19168-06 6x200 mm
 19168-08 8x200 mm
 19168-10 10x200 mm
 19168-12 12x200 mm
 19168-17 17x200 mm
 19168-20 20x200 mm
 19168-25 25x200 mm
 19169-25 25x250 mm



RIBBON

19170-20 20x330 mm
 19170-25 25x330 mm
 19170-32 32x330 mm
 19170-40 40x330 mm
 19170-45 45x330 mm
 19170-50 50x330 mm
 19170-65 65x330 mm
 19170-76 76x330 mm



41 cm, 16"

19171-30 30 mm
 19171-40 40 mm
 19171-50 50 mm
 19171-60 60 mm
 19171-70 70 mm

Bauch- und Darmspatel
 Abdominal and intestinal spatulas
 Separadores, espátula intestinal y abdominal
 Divaricatori, spatole addominali e intestinali

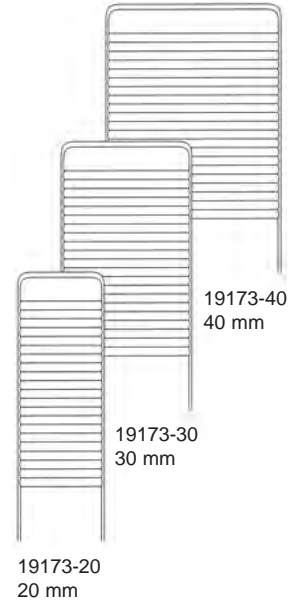

biegsam
 malleable
 malleable
 malleabili

HABERER
 19174-17 17/25x200 mm
 19174-25 25/30x280 mm
 19174-37 37/45x300 mm
 19174-40 40/50x300 mm



60 mm

45 mm

REVERDIN
 19175-28
 28 cm, 11"

Bauch- und Darmspatel
Abdominal and intestinal spatula
Separadores, espátula intestinal y abdominal
Divaricatori, spatole addominali e intestinali

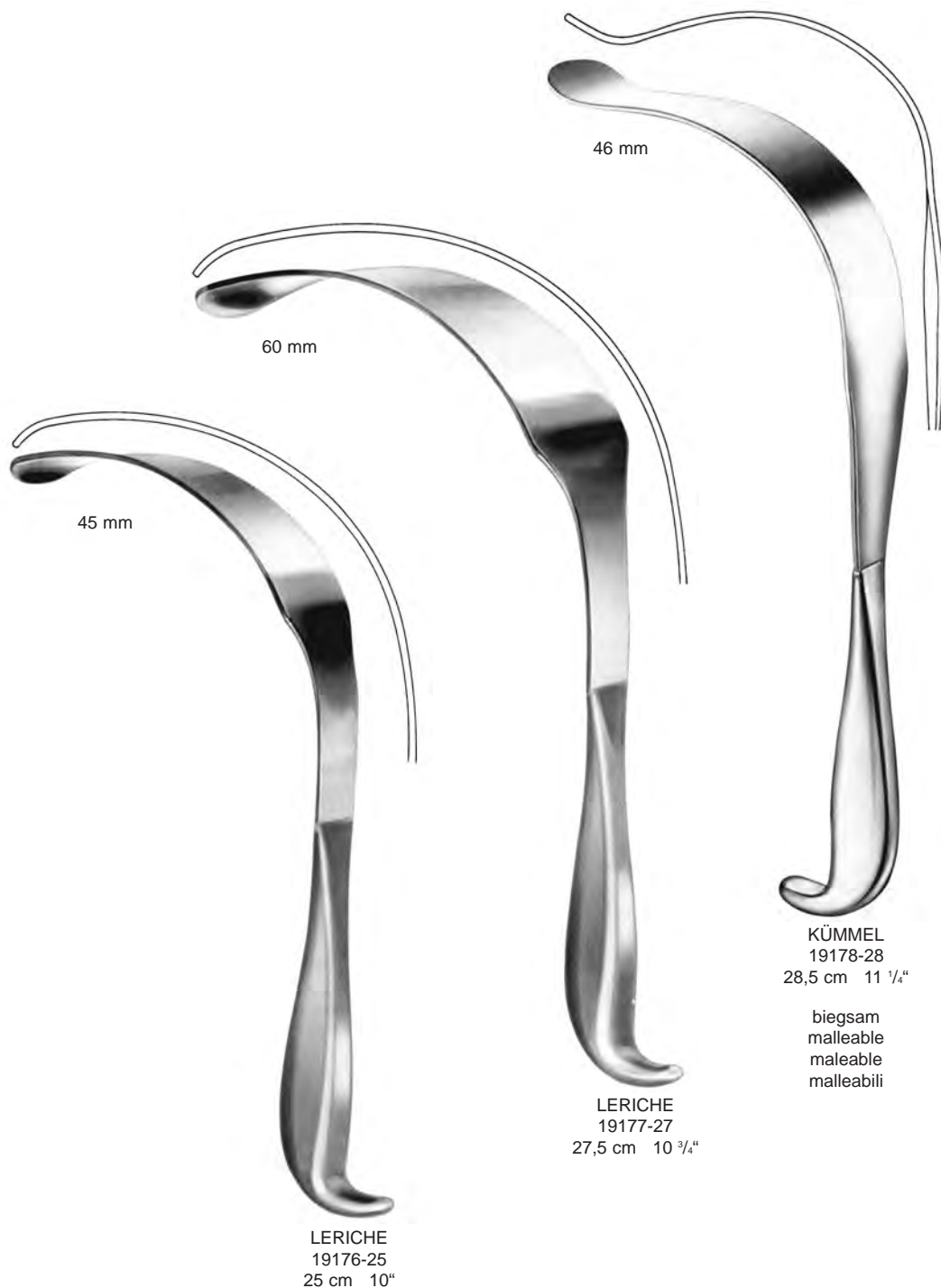

Bauchspatel
Abdominal Spatulas
Espátula abdominal
Spatola addominale

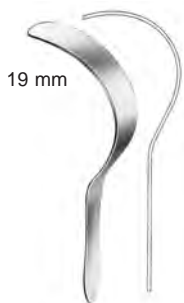

KÜMMEL
19179-28
31 cm 12 1/4"

Wundhaken
Retractors
Separadores
Divaricatori

19 mm

DEAVER
19180-19
19 cm, 7 1/2"

22 mm

DEAVER
19181-22
21,5 cm, 8 1/2"

25 mm

DEAVER
19181-25
23 cm, 9"

25 mm

DEAVER
19183-25
30 cm, 11 3/4"

25 mm

DEAVER
19185-25
33 cm, 13"

25 mm

DEAVER
19187-25
36 cm, 14"

Wundhaken
Retractors
Separadores
Divaricatori



DEAVER
19187-38 38x300 mm
30 cm, 11 ³/₄"



DEAVER
19187-50 50x300 mm
31 cm 12 ¹/₄"



DEAVER
19187-75 75x300 mm
32 cm, 12 ³/₄"



DEAVER GRIP
19189-25 25x310 mm
19189-38 38x310 mm
19189-50 50x310 mm
19189-75 75x310 mm
31 cm 12 ¹/₄"

Wundhaken
Retractors
Separadores
Divaricatori

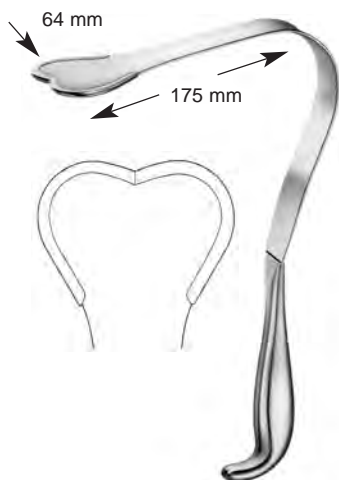

HARRINGTON-PEMBERTON
19190-64
29,5 cm 11 3/4"



HARRINGTON
19191-25 25x230 mm
19191-40 40x320 mm
19191-62 62x320 mm



64x60 mm

TUFFIER
19192-23

Wundhaken
Retractors
Separadores
Divaricatori

rechts
right
a la derecha
a destra
(45 mm x 48 mm)



COOLEY
19195-01
21,5 cm, 8 1/2"

rechts, gerieft
right serrated
a la derecha, estriado
a destra, zigrinato
(45 mm x 48 mm)



COOLEY
19195-02
21,5 cm, 8 1/2"

links
left
a la izquierda
a sinistra
(24 mm x 48 mm)



COOLEY
19195-03
23 cm, 9"

Hauthäkchen
 Nerve and wound hooks
 Ganchos y ganchitos para nervios
 Uncini per nervi e divaricatori fini



GRAEFE
 19210-12
 scharf
 sharp
 agudo
 acuto



GRAEFE
 19211-12
 stumpf
 blunt
 romo
 smusso



12 cm, 4 3/4"



GUTHRIE
 19212-01



GUTHRIE
 19212-02

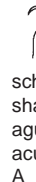

scharf
 sharp
 agudo
 acuto
 A

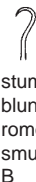

stumpf
 blunt
 romo
 smusso
 B

FRAZIER

- | | | |
|---|----------|-----------|
| A | 19214-13 | 13 cm, 5" |
| A | 19214-18 | 18 cm, 7" |
| B | 19215-13 | 13 cm, 5" |
| B | 19215-18 | 18 cm, 7" |



LAHEY
 12 cm, 4 3/4"



19215-01



19215-02



19215-03



JOSEPH
 16 cm, 6 1/4"



19216-01



19216-02
 2 mm



19216-05
 5 mm



19216-07
 7 mm



19216-10
 10 mm



KLEINERT-KUTZ
 13 cm, 5 1/8"



19217-03



19217-05



19217-07

Hauthäkchen
 Nerve and wound hooks
 Ganchos y ganchitos para nervios
 Uncini per nervi e divaricatori fini

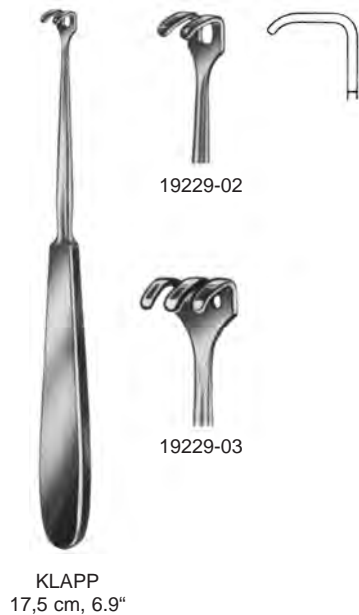
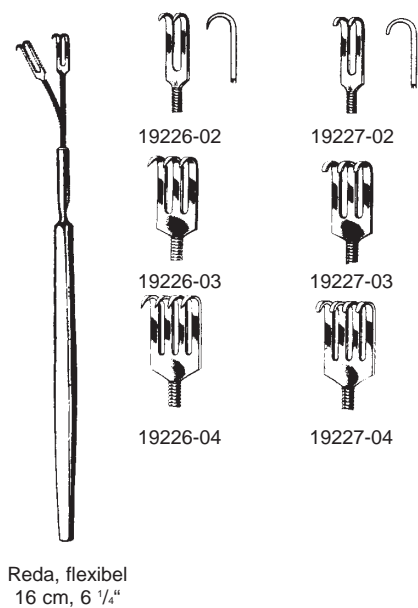
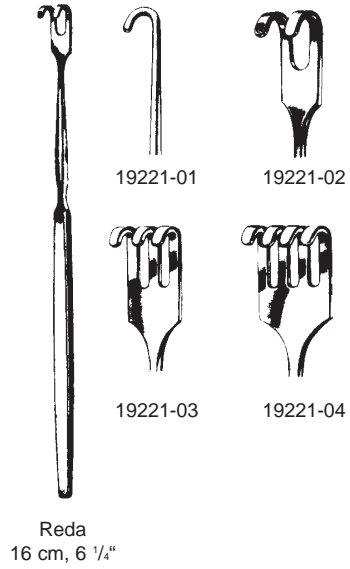
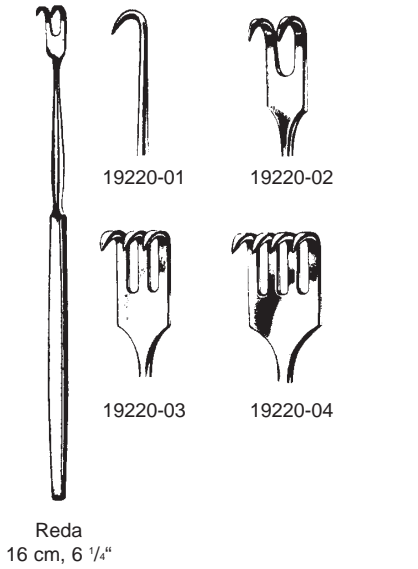

Wundhaken
Retractors
Separadores
Divaricatori

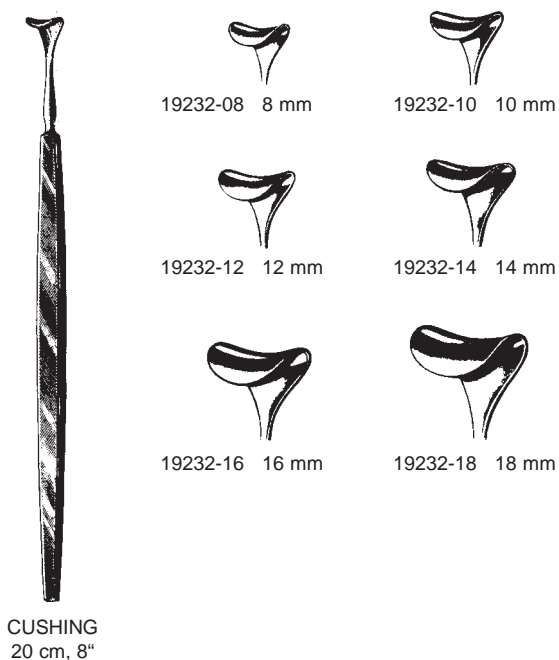
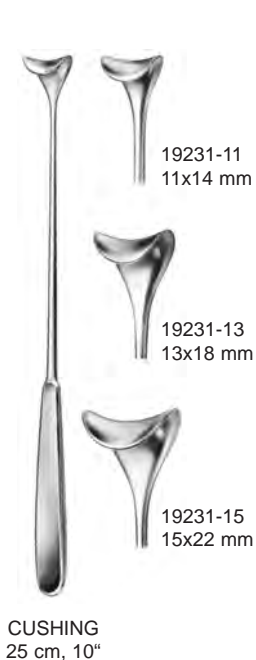
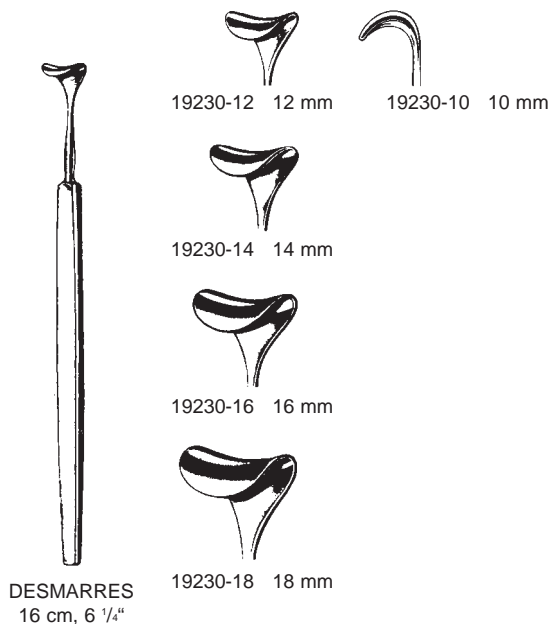

Wundhaken
Retractors
Separadores
Divaricatori



CUSHING
24 cm, 9 1/2"

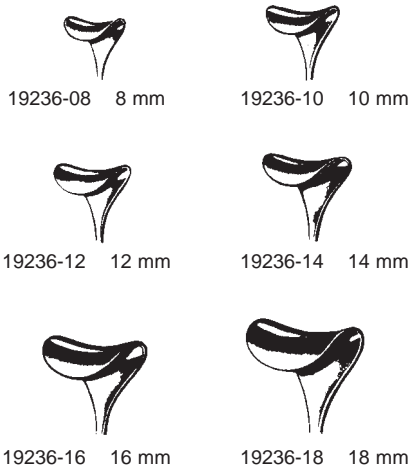

biegsam
malleable
maleable
malleabile

GIL-VERNET
19233-08 - 19233-23
24 cm, 9 1/2"

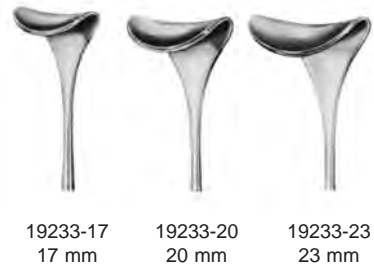
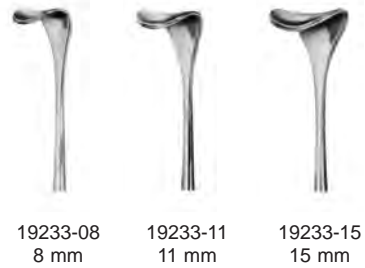

Wundhaken
Retractors
Separadores
Divaricatori



CUSHING
19234-20
20 cm, 8"



CUSHING
19235-21
21,5 cm, 8 1/2"

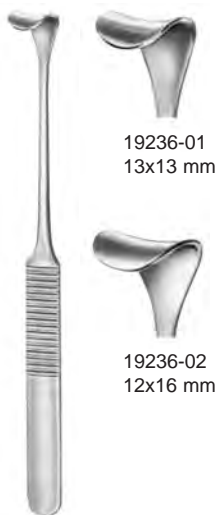

19236-01
13x13 mm

19236-02
12x16 mm

KÖNIG
18 cm, 7"

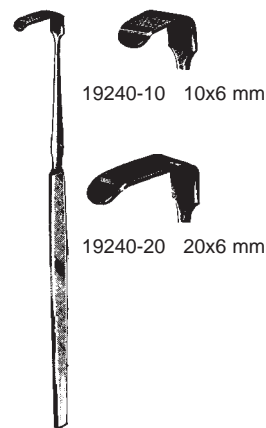

19240-10 10x6 mm

19240-20 20x6 mm

SENN-GREEN
15 cm, 6"



19250-16
16x6 mm

19250-24
24x6 mm

LANGENBECK-GREEN
16 cm, 6 1/4"

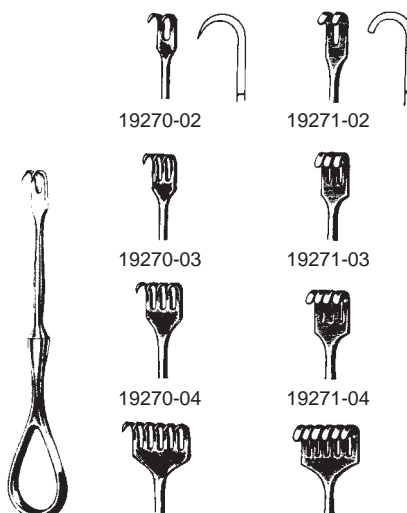

19270-02

19271-02

19270-03

19271-03

19270-04

19271-04

VOLKMANN
11,5 cm, 4 1/2"

19270-06

19271-06

Wundhaken
 Retractors
 Separadores
 Divaricatori



19280-01



19280-02



19280-03



19280-04



19280-06



scharf
 sharp
 agudo
 acuto



19281-01



19281-02



19281-03



19281-04



19281-06



stumpf
 blunt
 romo
 smusso



19282-02



19282-03



19282-04



19282-06



halbscharf
 semi-sharp
 medio romo
 mezzo smusso



VOLKMANN
 21,5 cm, 8 1/2"

Wundhaken
Retractors
Separadores
Divaricatori



19296-01



19296-02



19296-03



19296-04



19296-06



19296-08



19297-01



19297-02



19297-03



19297-04



19297-06

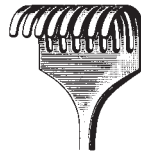

19297-08



KOCHER
19296-01 - 19297-08
22 cm, 8 ³/₄"

Wundhaken, Knochenhaken
 Retractors, Bone Retractors
 Separadores, Separadores oseos
 Divaricatori, Divaricatori per ossa



23 mm

scharf
 sharp
 agudo
 acuto

VOLKMANN
 19298-01
 22 cm 8 3/4"



23 mm

stumpf
 blunt
 romo
 smusso

VOLKMANN
 19299-01
 22 cm 8 3/4"

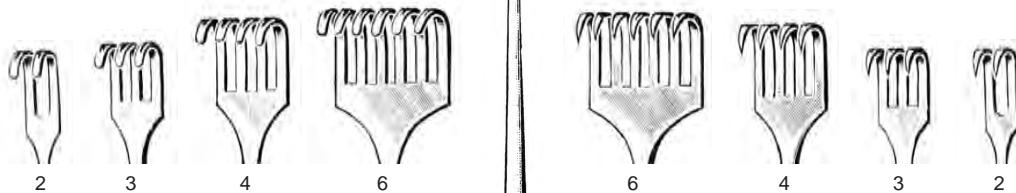

Zähne
 teeth
 dientes
 denti

2

3

4

6

6

4

3

2

stumpf
 blunt
 romo
 smusso

19301-02 8x 8 mm
 19301-03 8x13 mm
 19301-04 8x18 mm
 19301-06 8x28 mm

scharf
 sharp
 agudo
 acuto

19300-02 8x 8 mm
 19300-03 8x13 mm
 19300-04 8x18 mm
 19300-06 8x28 mm

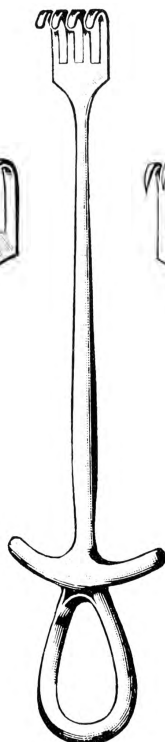

MURPHY
 19,4 cm 7 5/8"

Wundhaken
Retractors
Separadores
Divaricatori



MEYERDING
18 cm, 7"



19302-01 18x7 mm



19302-04 7x4 mm



19302-02 16x5 mm



19302-05 10x3 mm



19302-03 7x4 mm



19302-06 10x4 mm



28x6 mm



LAHEY
19304-19
19 cm, 7 1/2"



12x14 mm



LITTLE
19306-20
20 cm, 8"

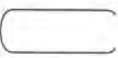

19307-01

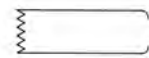

19307-02

STRANDELL-STILLE
17 cm 6 3/4"

Wundhaken
Retractors
Separadores
Divaricatori

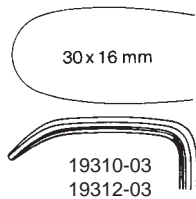
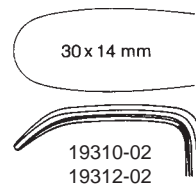
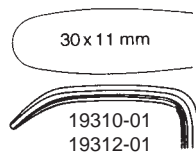
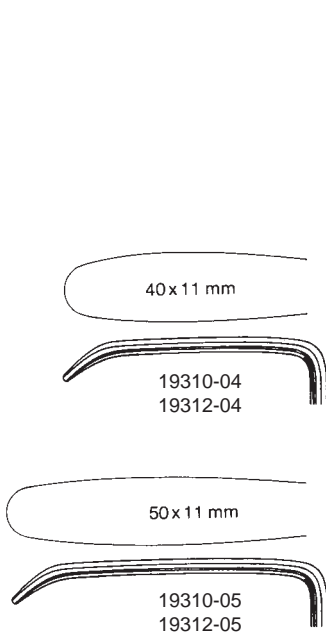

LANGENBECK
19310-01 - 19310-05
22 cm, 8 3/4"



LANGENBECK
19312-01 - 19312-05
21 cm, 8 1/4"

Wundhaken
Retractors
Separadores
Divaricatori

- 19314-07 35x 7 mm
- 19314-10 35x10 mm
- 19314-12 80x12 mm
- 19314-14 70x14 mm
- 19314-15 35x15 mm
- 19314-16 80x16 mm
- 19314-20 60x20 mm
- 19315-06 25x 6 mm
- 19330-40 40x12 mm
- 19330-55 55x11 mm

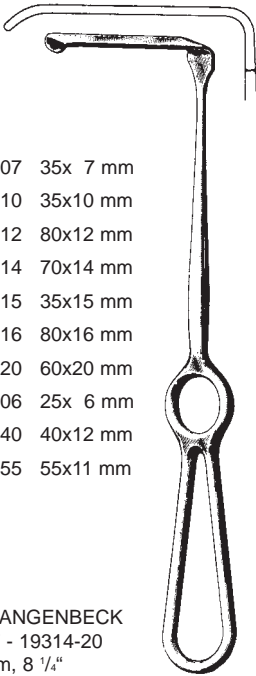

KOCHER-LANGENBECK
19314-07 - 19314-20
21 cm, 8 1/4"

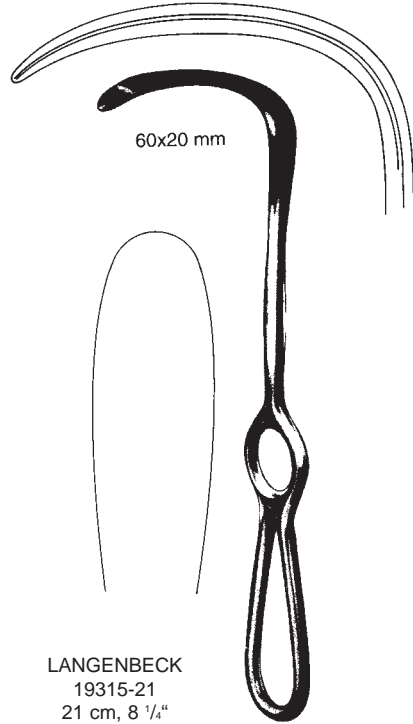

LANGENBECK
19315-21
21 cm, 8 1/4"



LANGENBECK
19317-21
21 cm, 8 1/4"

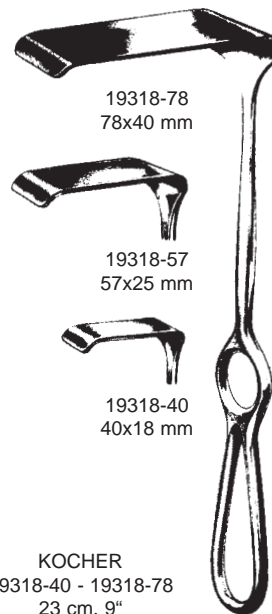

KOCHER
19318-40 - 19318-78
23 cm, 9"

Wundhaken
Retractors
Separadores
Divaricatori



19344-14
14x17 mm
21,5 cm, 8 1/2"



19344-20
20x22 mm
22 cm, 8 3/4"



19344-26
26x30 mm
23,5 cm, 9 1/4"



MIDDELDORF
19344-14 - 19344-26



KOCHER
19340-10 40x10 mm
19340-15 40x15 mm
19340-20 40x20 mm
22 cm, 8 3/4"

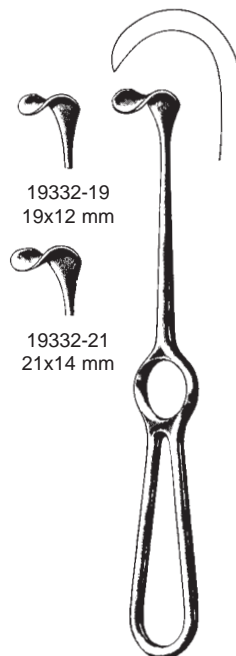

19332-19
19x12 mm

19332-21
21x14 mm

KOCHER
19332-19 - 19332-21
19 cm, 7 1/2"



MIDDELDORF
19345-01 45x45 mm
25,5 cm, 10"



19345-02
45x50 mm



19345-03
55x70 mm



GREEN
19348-22
22 cm, 8 3/4"

Wundhaken
Retractors
Separadores
Divaricatori



35 x 8 mm

ZENKER
19350-35
25 cm, 10"



60 x 12 mm

ZENKER
19350-60
26 cm, 10 1/4"



75 x 12 mm

ZENKER
19350-70
27,5 cm, 10.8"

Wundhaken
Retractors
Separadores
Divaricatori

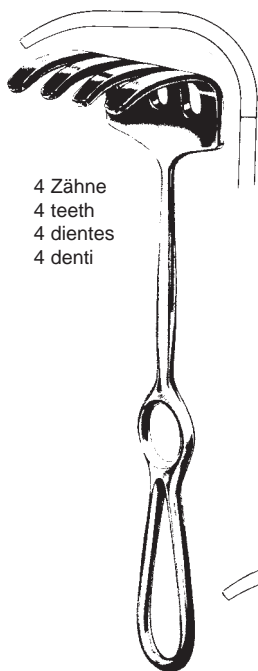

4 Zähne
4 teeth
4 dientes
4 denti

ISRAEL
19364-40 40X40 mm
25 cm, 10"

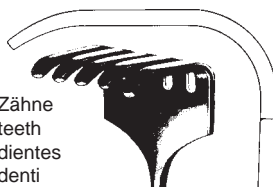

5 Zähne
5 teeth
5 dientes
5 denti

19364-50 45x50 mm

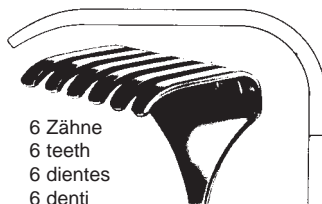

6 Zähne
6 teeth
6 dientes
6 denti

19364-60 50x60 mm



6 Zähne
6 teeth
6 dientes
6 denti

19364-70 70x70 mm

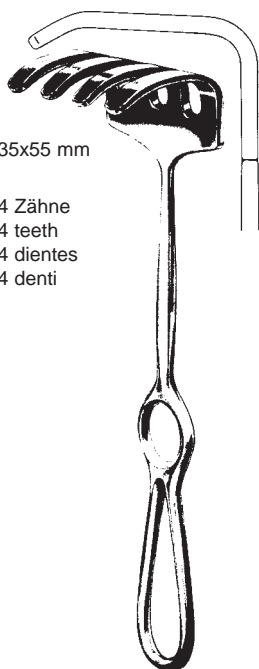

35x55 mm

4 Zähne
4 teeth
4 dientes
4 denti

OLLIER
19360-04 22,5 cm, 8.9"

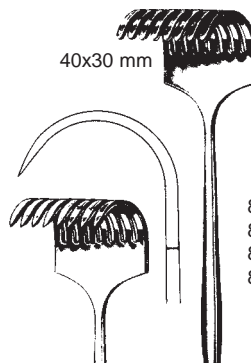

40x30 mm

8 Zähne
8 teeth
8 dientes
8 denti

spitz
sharp
agudo
acuto

stumpf
blunt
romo
smusso

KOERTE
19366-08 23,5 cm, 9 1/4" 19367-08

Wundhaken
Retractors
Separadores
Divaricatori

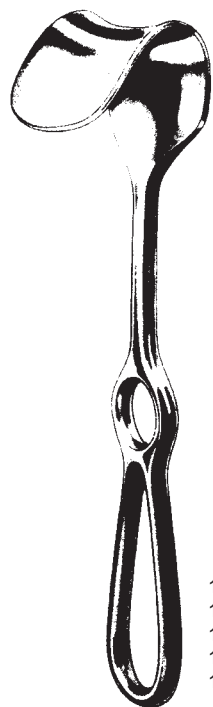

FRITSCH
19370-40 45x40 mm
19370-50 45x50 mm
19370-60 45x60 mm
19370-75 45x75 mm
19370-85 65x85 mm
24 cm, 9 1/2"

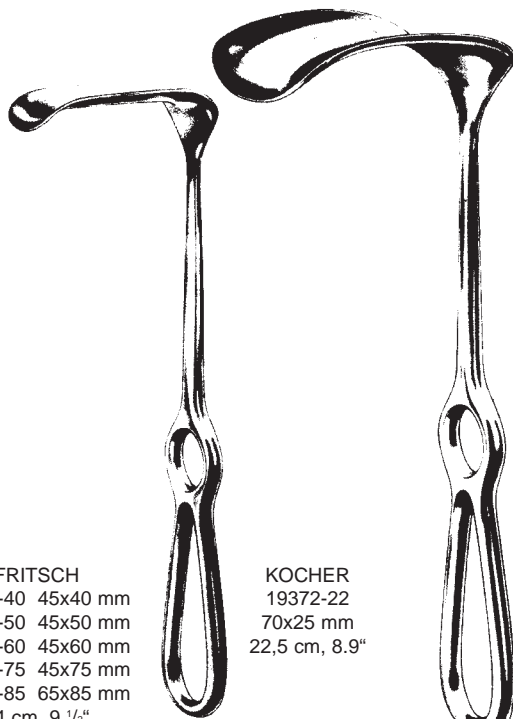

KOCHER
19372-22
70x25 mm
22,5 cm, 8.9"



KOCHER
19374-45 80x45 mm
19374-55 80x55 mm
19374-65 80x65 mm
25 cm, 10"

50x85 mm

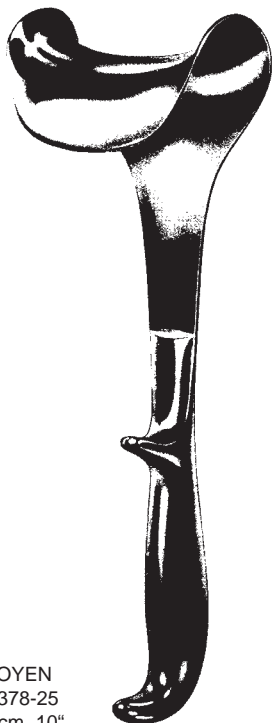

DOYEN
19378-25
25 cm, 10"

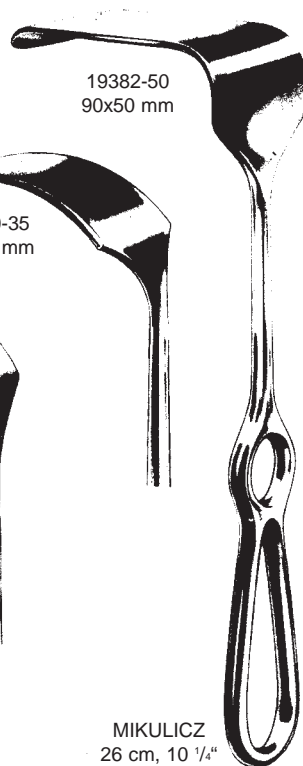

19382-50
90x50 mm

19380-35
95x35 mm

19380-50
120x50 mm

19381-50
150x50 mm

MIKULICZ
26 cm, 10 1/4"

Wundhaken
Retractors
Separadores
Divaricatori



19388-40 70x40 mm
19388-50 70x50 mm
19388-65 70x65 mm

MORRIS
24,5 cm
9 3/4"



SIMON
19480-22 115x22 mm
19480-27 115x27 mm
28 cm, 11"

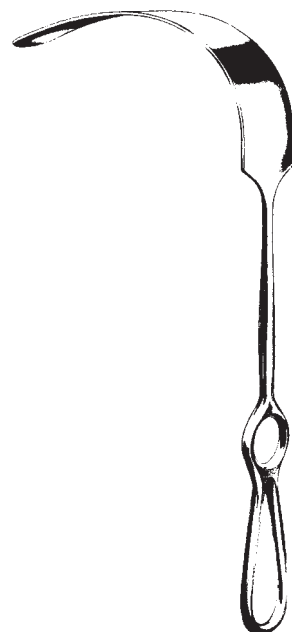

KELLY
19385-38 160x38 mm
19385-57 160x57 mm
27 cm, 10 1/2"



19482-82
82x28 mm

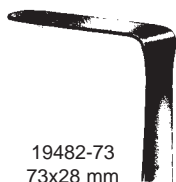

19482-73
73x28 mm



19482-45
45x25 mm

HEANEY
19482-45 - 19482-82
27 cm, 10 1/2"

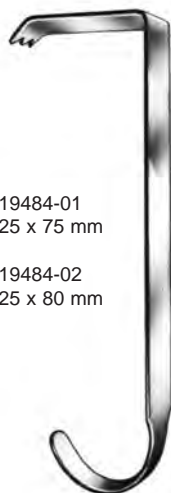

19484-01
25 x 75 mm

19484-02
25 x 80 mm

HIBBS
24 cm, 9 1/2"



125x37 mm

SAUERBRUCH
19492-25
25 cm, 10"

Wundhaken
Retractors
Separadores
Divaricatori

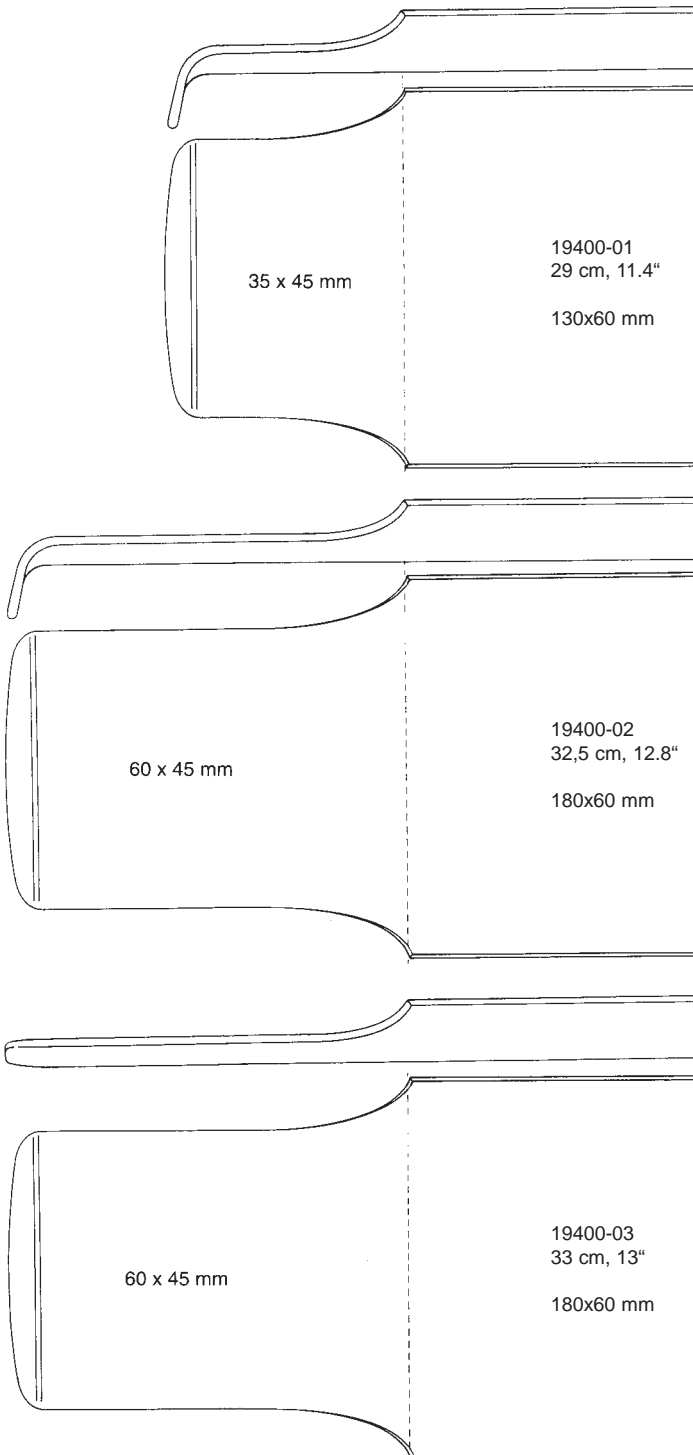

Pelvis-Haken
Pelvis retractor
Retractor de pelvis
Divaricatori pelvici



ST. MARKS
19400-01 19400-03

Wundhaken
Retractors
Separadores
Divaricatori

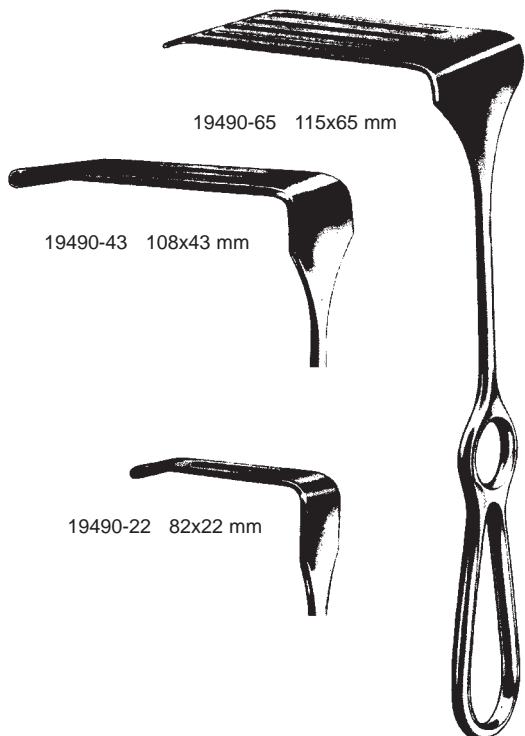

19490-65 115x65 mm

19490-43 108x43 mm

19490-22 82x22 mm

CORYLLOS (Thorax)
19490-22 - 19490-65
24 cm, 9 1/2"

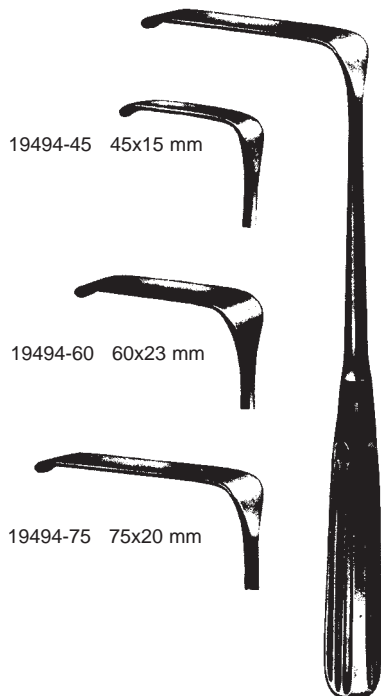

19494-45 45x15 mm

19494-60 60x23 mm

19494-75 75x20 mm

SAUERBRUCH
19494-45 - 19494-75
22,5 cm, 8.9"



DAVIDSON (Scapula)
19496-50 75x50 mm



DAVIDSON (Scapula)
19496-90 75x90 mm

Wundhaken
Retractors
Separadores
Divaricatori

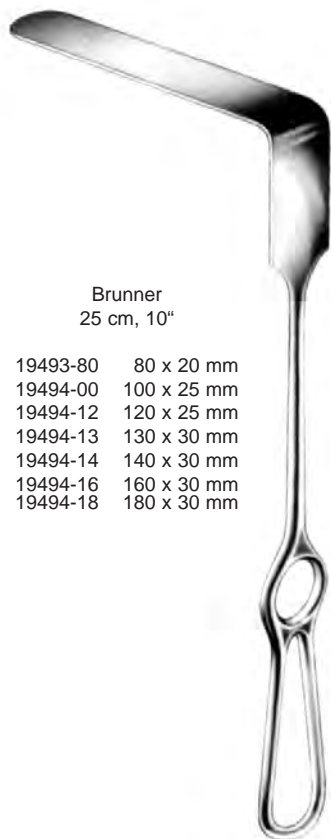

Brunner
25 cm, 10"

19493-80	80 x 20 mm
19494-00	100 x 25 mm
19494-12	120 x 25 mm
19494-13	130 x 30 mm
19494-14	140 x 30 mm
19494-16	160 x 30 mm
19494-18	180 x 30 mm



Hösel
25 cm, 10"

19495-60	60 x 20 mm
19495-80	80 x 30 mm
19496-00	100 x 30 mm
19496-12	120 x 30 mm
19496-14	140 x 30 mm
19497-14	140 x 40 mm



Doyen-Stillé
25 cm, 10"

19498-01	97 x 29 mm
19498-02	101 x 31 mm
19498-03	127 x 52 mm

Wundsperrer
Retractors
Separadores
Divaricatori

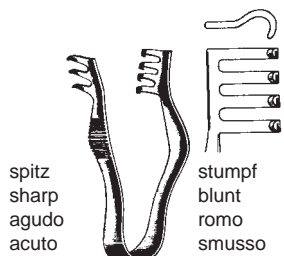

spitz
sharp
agudo
acuto

stumpf
blunt
romo
smusso

FINSEN
19610-07 7 cm, 2 3/4" 19611-07

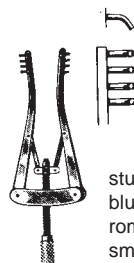

spitz
sharp
agudo
acuto

stumpf
blunt
romo
smusso

ALM
19620-07 7 cm, 2 3/4" 19621-07
19620-10 10 cm, 4" 19621-10



JANSEN
19630-10
10 cm, 4"



JANSEN
19631-10
10 cm, 4"



spitz
sharp
agudo
acuto

stumpf
blunt
romo
smusso

HOLZHEIMER
19634-10 19635-10
10 cm, 4"



PERKINS
19636-14
13 cm, 5 1/8"



PERKINS
19637-14
13 cm, 5 1/8"

Wundsperrer
Retractors
Separadores
Divaricatori

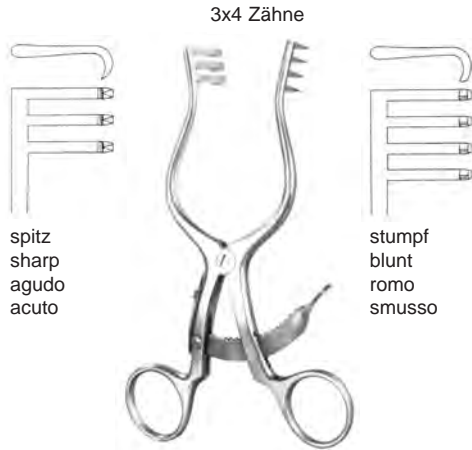

SCALP-CONTOUR
19640-14 - 19641-14
13,5 cm, 5 1/4"

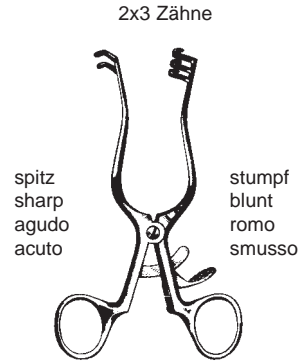

WEITLANER
19650-10 19651-10
11,5 cm, 4 1/2"

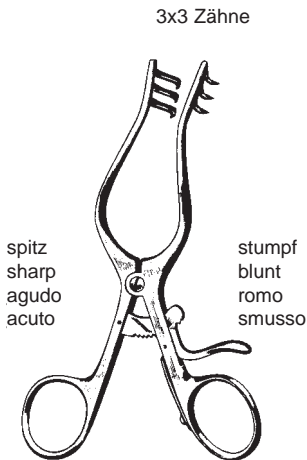

WEITLANER-WULLSTEIN
19654-13 19655-13
13 cm, 5 1/8"

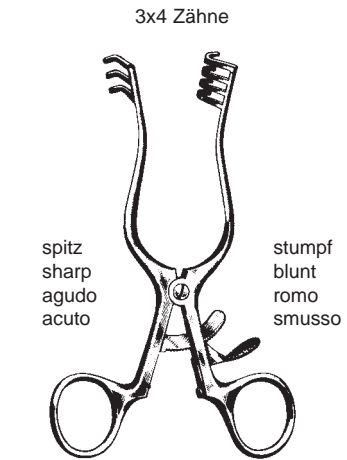

WEITLANER
19670-14 14,0 cm, 5 1/2" 19671-14
19670-16 16,5 cm, 6 1/2" 19671-16
19670-20 20,0 cm, 8" 19671-20
19670-24 24,0 cm, 9 1/2" 19671-24

Wundsperrer
Retractors
Separadores
Divaricatori

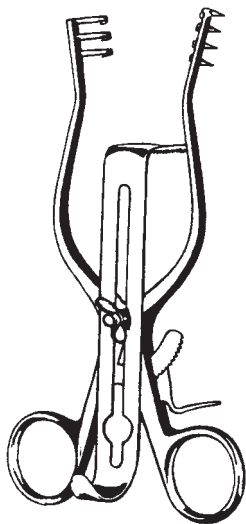

HENLEY
19675-00 - 19677-32
16,5 cm, 6 1/2"



19675-00 komplett, stumpf, 3x4 Z. und 3 Valven
19675-00 complete, blunt, 3x4 teeth and 3 blades
19675-00 completo, romo, 3x4 dientes y 3 valvas
19675-00 completo, smusso, 3x4 d. e 3 valve

19676-00 komplett, scharf, 3x4 Z. und 3 Valven
19676-00 complete, sharp, 3x4 teeth and 3 blades
19676-00 complete, agudo, 3x4 dientes y 3 valvas
19676-00 completo con retr. acuto 3x4 d. e 3 valve

19678-05 Retraktor allein, stumpf 3x4 Zähne
19678-05 Retractor only, blunt 3x4 teeth
19678-05 Separador solo, romo, 3x4 dientes
19678-05 Retrattore solo, smusso 3x4 denti

19678-06 Retraktor allein, spitz 3x4 Zähne
19678-06 Retractor only, sharp 3x4 teeth
19678-06 Separador solo, agudo, 3x4 dientes
19678-06 Retrattore solo, acuto 3x4 denti



19677-19
16x19 mm
5/8" x 3/4"

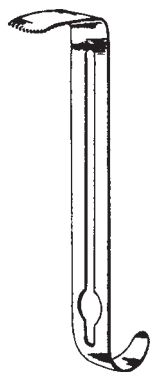

19677-25
16x25 mm
5/8" x 1"

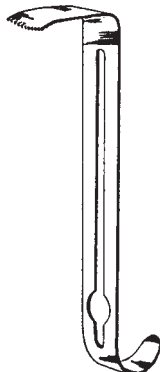

19677-32
16x32 mm
5/8" x 1 1/4"

Wundsperrer
Retractors
Separadores
Divaricatori



PLESTER
19672-11 11 cm, 4 3/8"
stumpf - blunt - romo - smusso



PLESTER
19673-11 11 cm, 4 3/8"
stumpf - blunt - romo - smusso

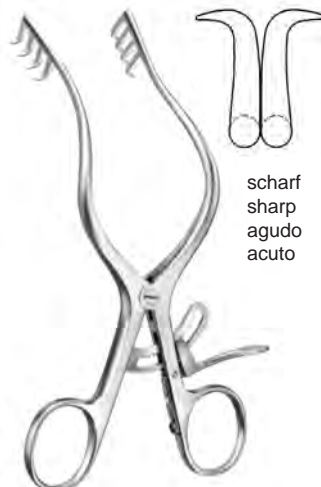

MOLLISON
19674-15 15 cm, 6"

scharf
sharp
agudo
acuto



WULLSTEIN
19675-13
13 cm, 5 1/8"



PLESTER
19677-13
13 cm, 5 1/8"

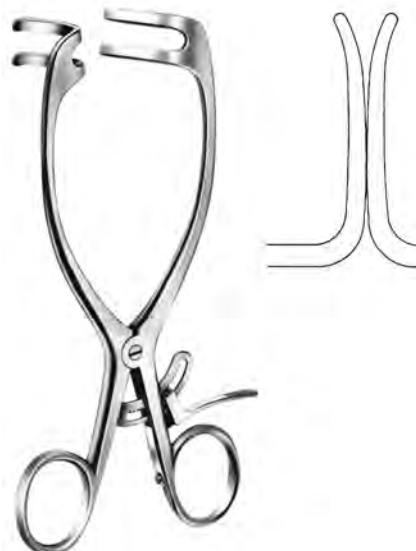

MAYO-ADAMS
19678-16
16,5 cm, 6 1/2"

Wundsperrer
Retractors
Separadores
Divaricatori

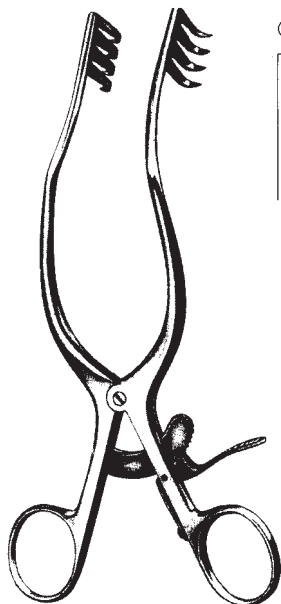

ANDERSON ADSON
19679-20 19,5 cm, 7 3/4"



NORFOLK / NORWICH
19679-22 22 cm, 8 3/4"



spitz
sharp
agudo
acuto

ADSON
19680-19 19 cm, 7 1/2" 19681-19

stumpf
blunt
romo
smusso



TRAVERS
19681-21 21,5 cm, 8 1/2"

Wundsperrer
Retractors
Separadores
Divaricatori

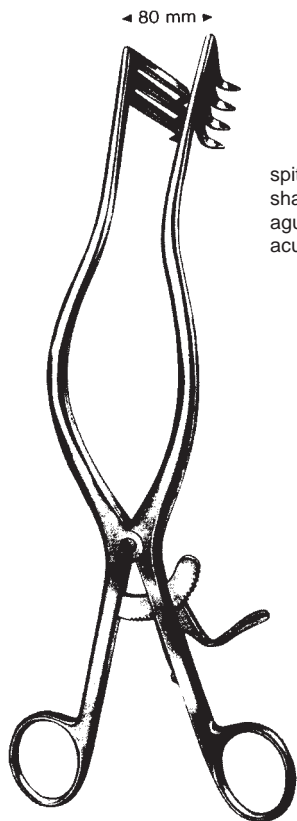

◀ 80 mm ▶

spitz
sharp
agudo
acuto

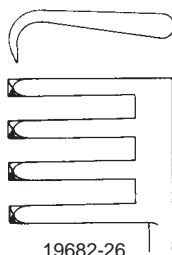

19682-26

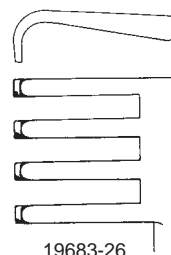

stumpf
blunt
romo
smusso

19683-26

ADSON
19682-26 - 19683-26
26,5 cm, 10 1/2"

- 19684-14 14 cm, 5 1/2"
- 19684-16 16 cm, 6 1/4"
- 19684-20 20 cm, 8"
- 19684-26 26 cm, 10 1/4"

spitz
sharp
agudo
acuto

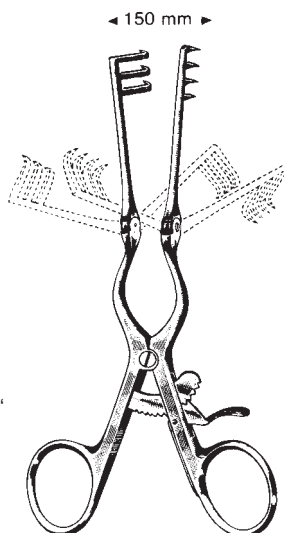

◀ 150 mm ▶

- 19685-14 14 cm, 5 1/2"
- 19685-16 16 cm, 6 1/4"
- 19685-20 20 cm, 8"
- 19685-26 26 cm, 10 1/4"

stumpf
blunt
romo
smusso

ADSON

Wundsperrer
Retractors
Separadores
Divaricatori

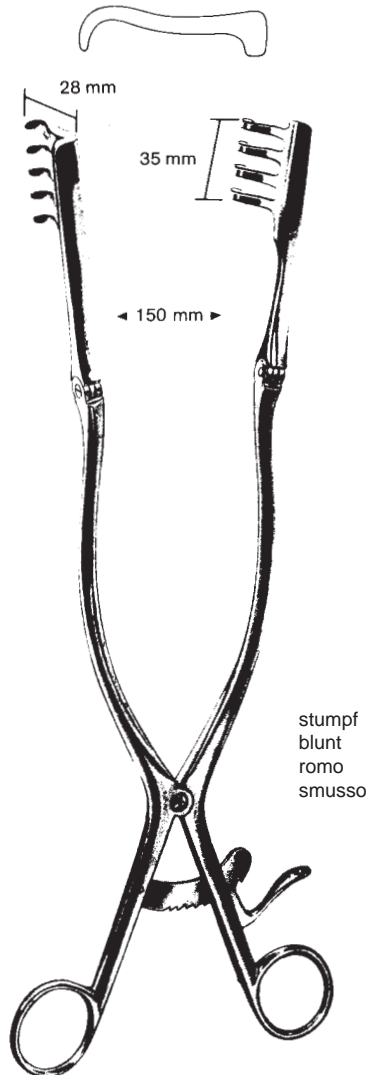

ADSON
19686-32
32 cm, 12 ³/₄"

Wundsperrer
Retractors
Separadores
Divaricatori



Beckman-Adson
31 cm, 12 1/4"

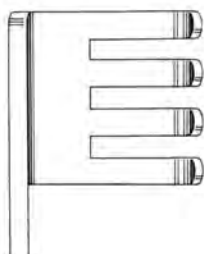

19687-01
25 x 27 mm

stumpf
blunt
romo
smusso

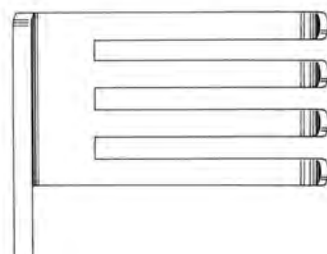

19688-01
45 x 27 mm

stumpf
blunt
romo
smusso

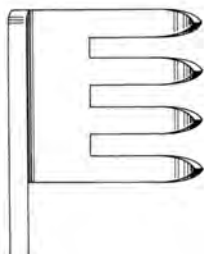

19687-02
25 x 27 mm

scharf
sharp
agudo
acuto

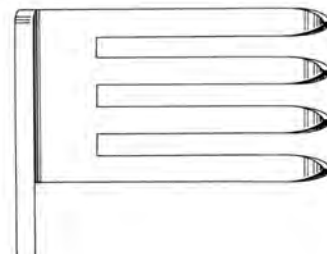

19688-02
45 x 27 mm

scharf
sharp
agudo
acuto

Wundsperrer
Retractors
Separadores
Divaricatori



MARTIN
28,5 cm, 11 1/4"

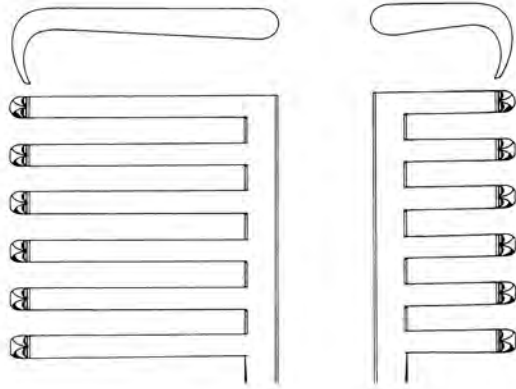

19689-01
6x6 Zähne

scharf, lange Zähne links
sharp, long teeth on left side
agudo, dientes largos a la izquierda
acuto, denti lunghe a sinistra

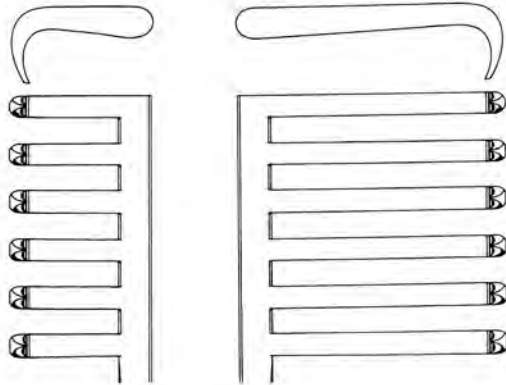

19689-02
6x6 Zähne

scharf, lange Zähne rechts
sharp, long teeth on right side
agudo, dientes largos a la derecha
acuto, denti lunghe a destra

Wundsperrer
Retractors
Separadores
Divaricatori

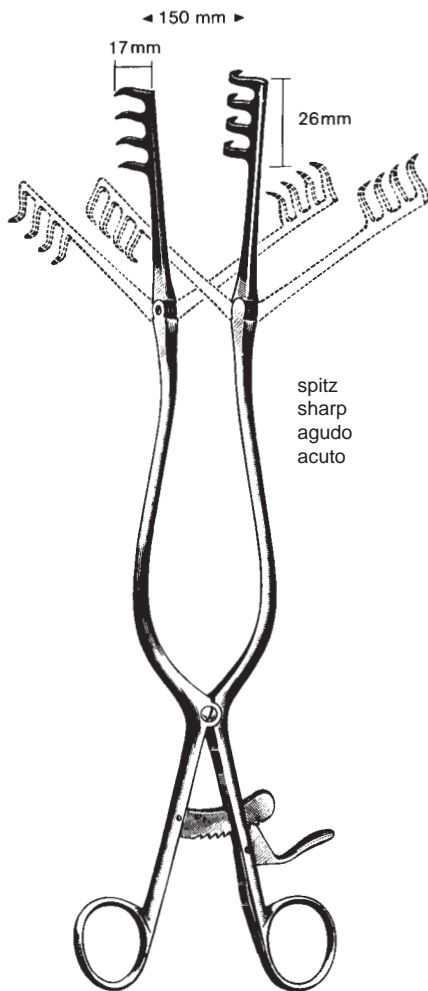

spitz
sharp
agudo
acuto

BECKMANN
19690-31
31 cm, 12 1/4"

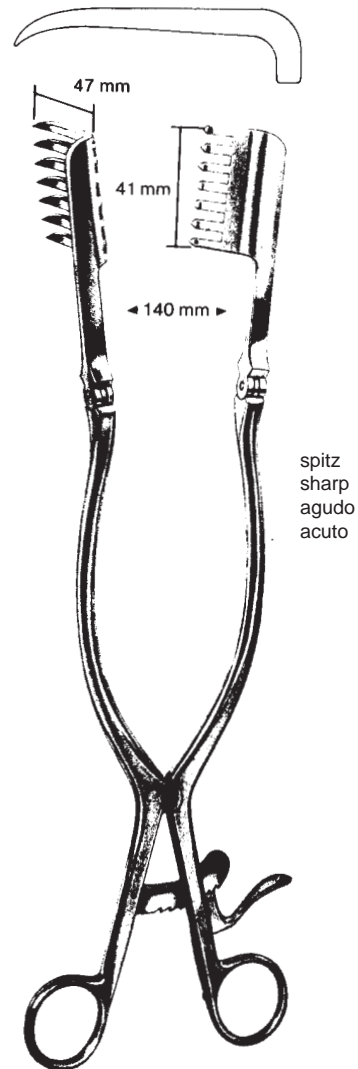

spitz
sharp
agudo
acuto

BECKMANN-EATON
19692-32
32 cm, 12 3/4"

Wundhaken
Retractors
Separadores
Divaricatori

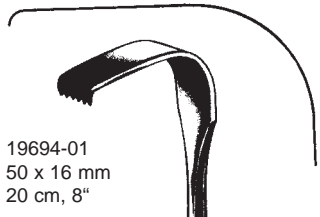

19694-01
50 x 16 mm
20 cm, 8"

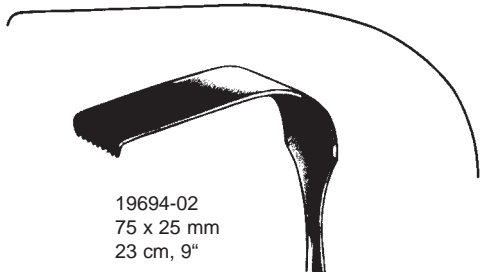

19694-02
75 x 25 mm
23 cm, 9"



19694-03
90 x 50 mm
24 cm, 9 1/2"

MEYERDING

Wundsperrer
Retractors
Separadores
Divaricatori

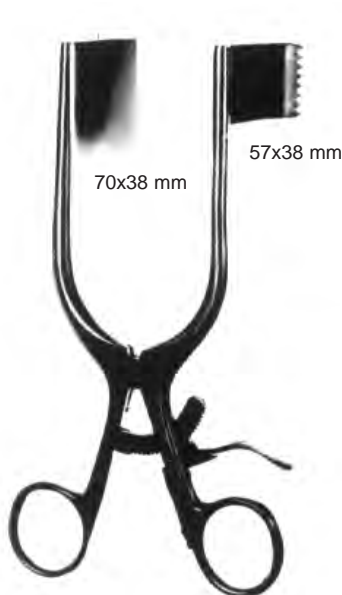

DARLING
19696-18 18 cm, 7"



DARLING
19698-18 18 cm, 7"



CLOWARD
25 cm, 10"

19710-01

19710-00
Sperrer komplett mit 5 Valven spitz
Retractor complete with 5 blades sharp
Separador completo con 5 valvas agudas
Divaricatore completo con 5 valve acute

19712-00
Sperrer komplett mit 5 Valven stumpf
Retractor complete with 5 blades blunt
Separador completo con 5 valvas romas
Divaricatore completo con 5 valve smusse



CLOWARD
16 cm, 6 1/4"

19711-01

19711-00
Sperrer komplett mit 5 Valven spitz
Retractor complete with 5 blades sharp
Separador completo con 5 valvas agudas
Divaricatore completo con 5 valve acute

19713-00
Sperrer komplett mit 5 Valven stumpf
Retractor complete with 5 blades blunt
Separador completo con 5 valvas romas
Divaricatore completo con 5 valve smusse

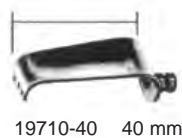

19710-40 40 mm



19710-45 45 mm



19710-50 50 mm



19710-55 55 mm



19710-60 60 mm



19711-40 40 mm



19711-45 45 mm



19711-50 50 mm



19711-55 55 mm



19711-60 60 mm

Laminektomie-Wundspreizer
 Retractors, Cercical Spine
 Separadores, columna vertebral
 Divaricatori, spina cervicale



CASPAR
 19720-00 compl.
 (5 valven, 5 valves, 5 blades, 5 valvas, 5 valve)
 19720-15
 ohne Blätter, without blades, sin valvas, senza valve



CASPAR
 19721-00 compl.
 (5 valven, 5 valves, 5 blades, 5 valvas, 5 valve)
 19721-15
 ohne Blätter, without blades, sin valvas, senza valve



CASPAR
 19724-00 compl. (5 valven, 5 valves, 5 blades, 5 valvas, 5 valve)
 19724-11 ohne Blätter, without blades, sin valvas, senza valve



medial

- CASPAR
- 19724-40 40x20 mm
 - 19724-45 45x20 mm
 - 19724-50 50x20 mm
 - 19724-55 55x20 mm
 - 19724-60 60x20 mm



lateral

- CASPAR
- 19725-40 40x20 mm
 - 19725-45 45x20 mm
 - 19725-50 50x20 mm
 - 19725-55 55x20 mm
 - 19725-60 60x20 mm

Laminektomie-Wundspreizer
Retractors
Separadores
Divaricatori



19745-40 40 mm



19745-45 45 mm



19745-50 50 mm



19745-55 55 mm



19745-60 60 mm



19745-65 65 mm



19745-70 70 mm

CASPAR

19744-00 compl. incl. 7 Blätter, compl. incl. 7 blades, valvas, valva
19744-17 ohne Blätter, without blades, sin valvas, senza valva



19747-45 45 mm

19747-50 50 mm

19747-55 55 mm

19747-60 60 mm

19747-65 65 mm



CASPAR
19747-45 - 19747-65

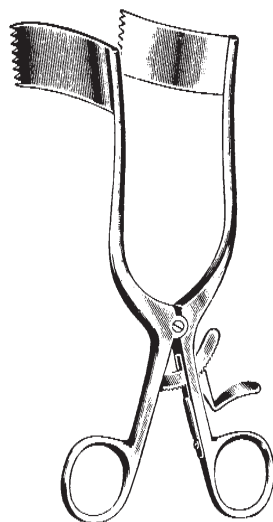

MEYERDING
17 cm, 6 3/4"

19748-01 2,5 x 3,2 cm

19748-02 2,5 x 5,4 cm

19748-03 1,9 x 6,0 cm

19748-04 2,5 x 6,0 cm

Bauchdeckenhalter
 Abdominal Retractors
 Separadores abdominales
 Divaricatori addominali

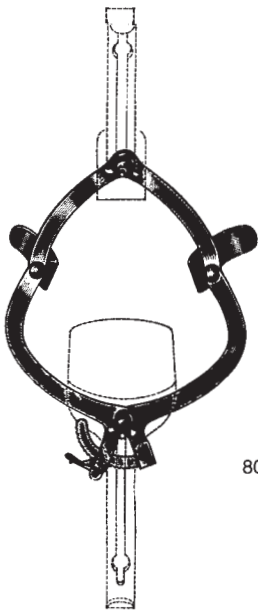

O'SULLIVAN - O'CONNOR
 19754-00
 compl.

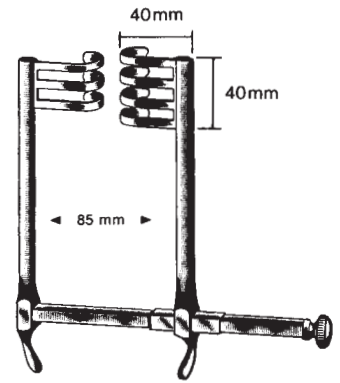
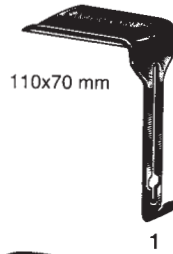

FRAZIER
 19758-85

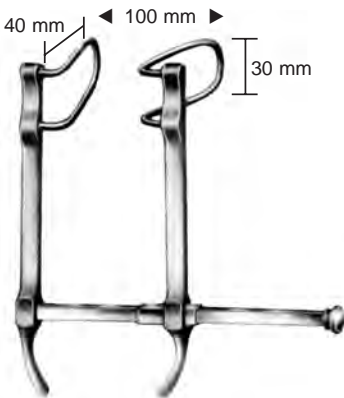

BABY GOSSET
 19759-00

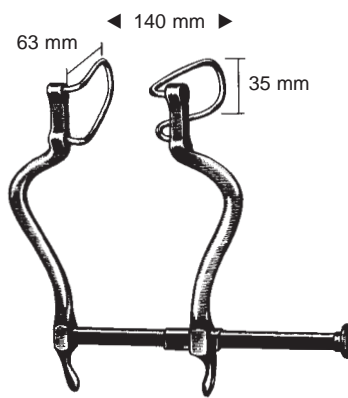

GOSSET
 19760-14

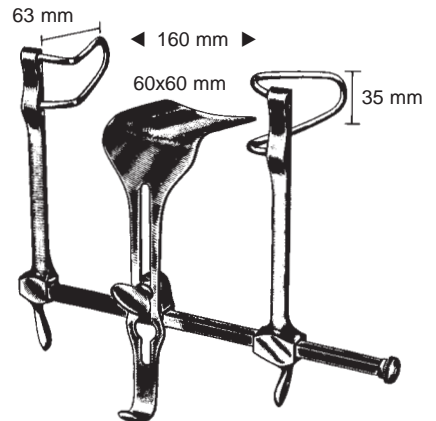

GOSSET
 19762-16

Bauchdeckenhalter
Abdominal Retractors
Separadores abdominales
Divaricatori addominali

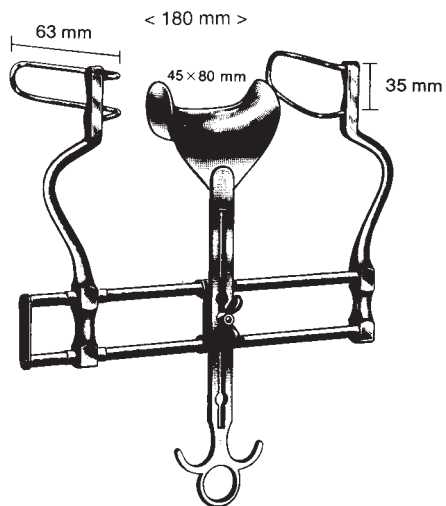

BALFOUR
19764-18
18 cm, 7"

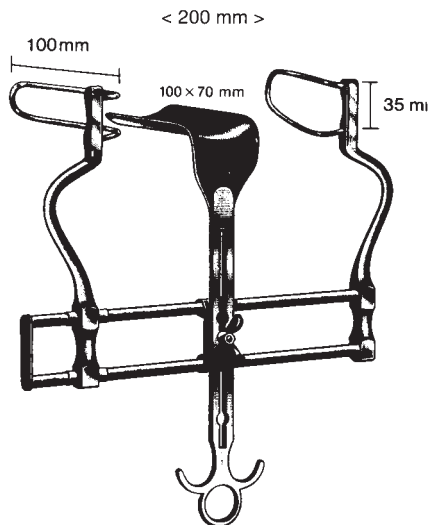

BALFOUR
19764-20
20 cm, 8"

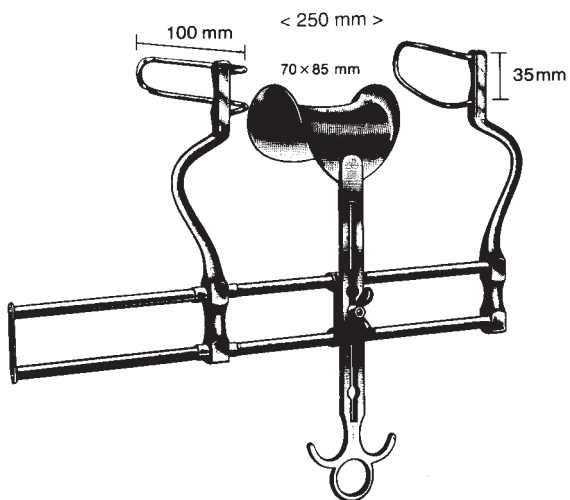

BALFOUR
19764-25
25 cm, 10"

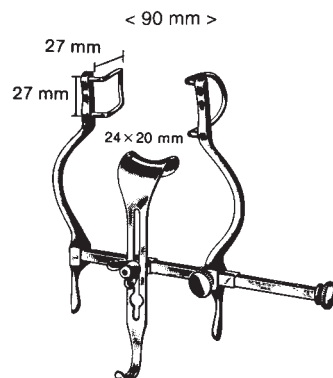

BALFOUR Baby
19766-90
9 cm, 3 1/2"

Bauchdeckenhalter
Abdominal Retractors
Separadores abdominales
Divaricatori addominali

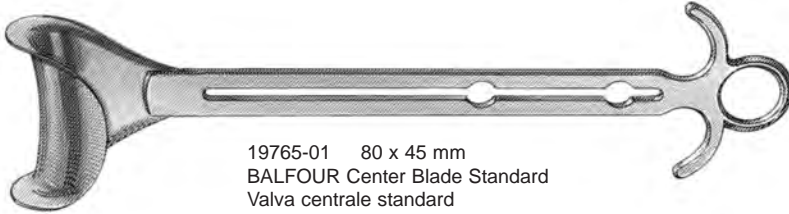

19765-01 80 x 45 mm
BALFOUR Center Blade Standard
Valva centrale standard
Valva central estándar

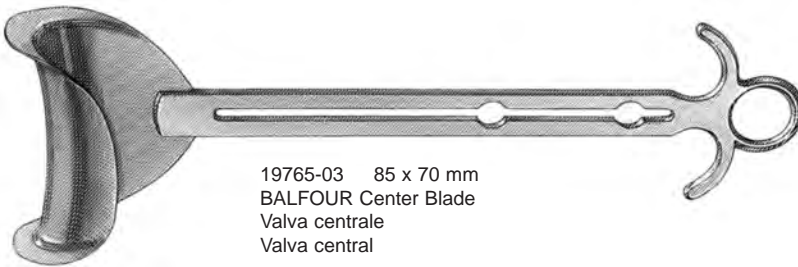

19765-03 85 x 70 mm
BALFOUR Center Blade
Valva centrale
Valva central

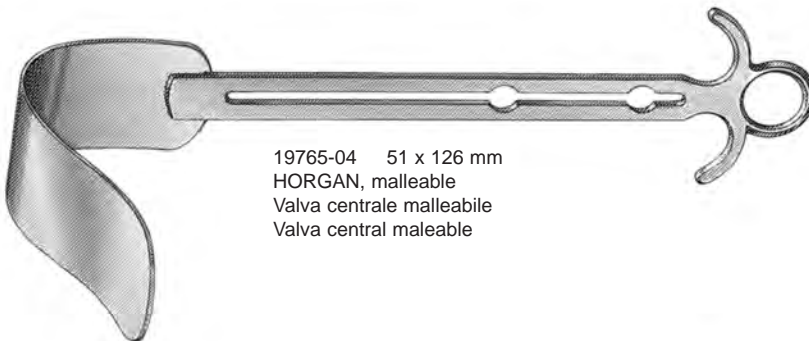

19765-04 51 x 126 mm
HORGAN, malleable
Valva centrale malleabile
Valva central maleable

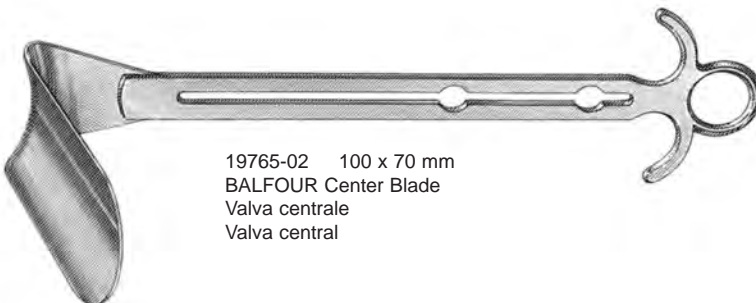

19765-02 100 x 70 mm
BALFOUR Center Blade
Valva centrale
Valva central

Bauchdeckenhalter
Abdominal Retractors
Separadores abdominales
Divaricatori addominali



19767-01
Drahtvalven 6 cm (2.4") tief (Paar)
Fenestrated blades 6 cm (2.4") deep (pair)
Valvas de alambre 6 cm (2.4") profundidad (par)
Valve di filo profondità 6 cm (2.4") (paio)



19767-02
Drahtvalven 8 cm (3 1/8") tief (Paar)
Fenestrated blades 8 cm (3 1/8") deep (pair)
Valvas de alambre 8 cm (3 1/8") profundidad (par)
Valve di filo profondità 8 cm (3 1/8") (paio)



BALFOUR-US
19767-18
komplett
complete
completo

Bauchdeckenhalter
Abdominal Retractors
Separadores abdominales
Divaricatori addominali

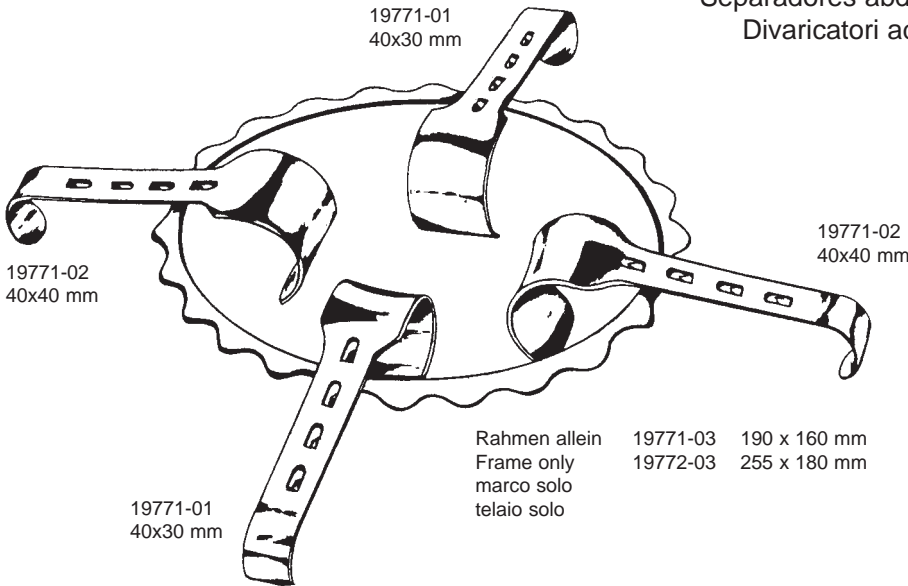

DENIS-BROWNE

19771-00 compl. Pediatric/pediatrico 190 x 160 mm
19772-00 compl. Adult/adulto 255 x 190 mm

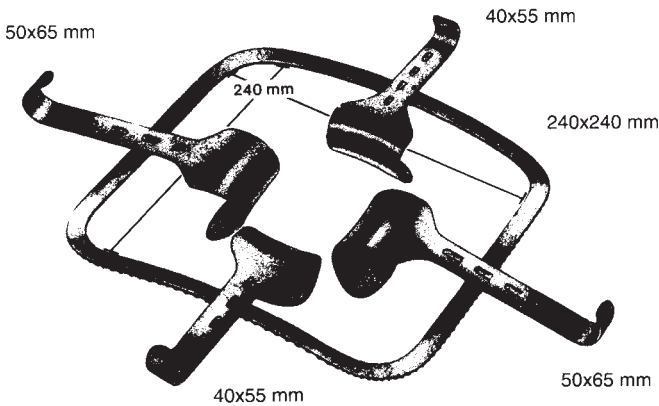

KIRSCHNER

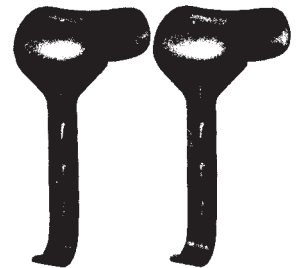

19781-55 (2 St./p.)
40 x 55 mm breit



19781-65 (2 St./p.)
50 x 65 mm breit

19782-00 Kirschner Bauchdeckenhalter komplett bestehend aus:
Kirschner Abdominal Retr. complete consisting of:
Kirschner separador abdominal, completo compuesto de:
Kirschner Divaricatore addominale completo, composto da:

19781-55 2 Rahmenhaken / 2 Hook-on Retr. / 2 separadores / 2 divaricatori 40 x 55 mm
19781-65 2 Rahmenhaken / 2 Hook-on Retr. / 2 separadores / 2 divaricatori 50 x 65 mm
19783-24 Rahmen fest / frame rigid / marco rigido / telaio rigido 240 x 240 mm

Bauchdeckenhalter
 Abdominal Retractors
 Separadores abdominales
 Divaricatori addominali

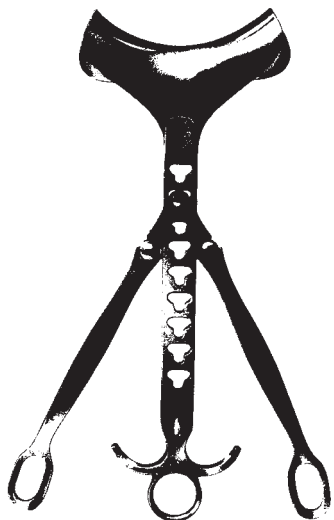

19780-01 + 19770-01

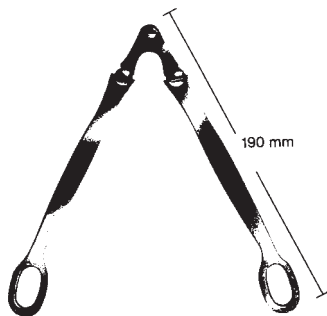

ROCHARD
 19780-01

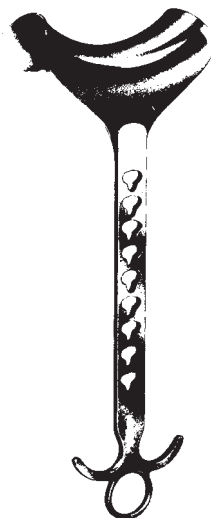

ROCHARD
 31 cm, 12 1/4"
 19770-01 48x 90 mm
 19770-02 48x105 mm
 19770-03 48x120 mm
 19770-04 48x135 mm
 19770-05 48x155 mm

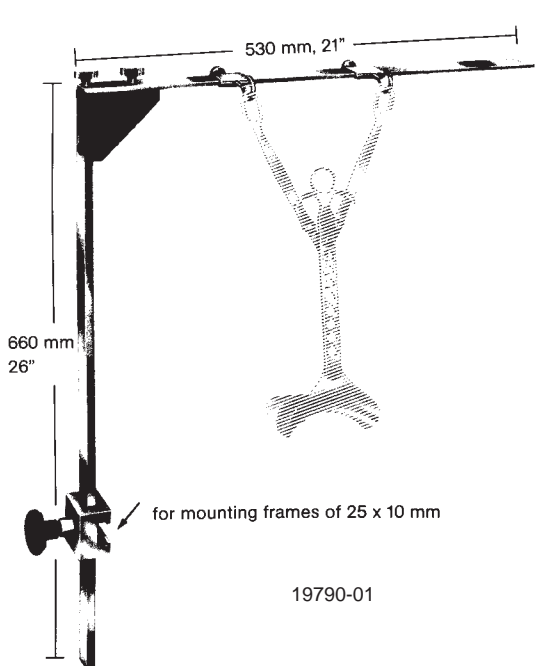

19790-01

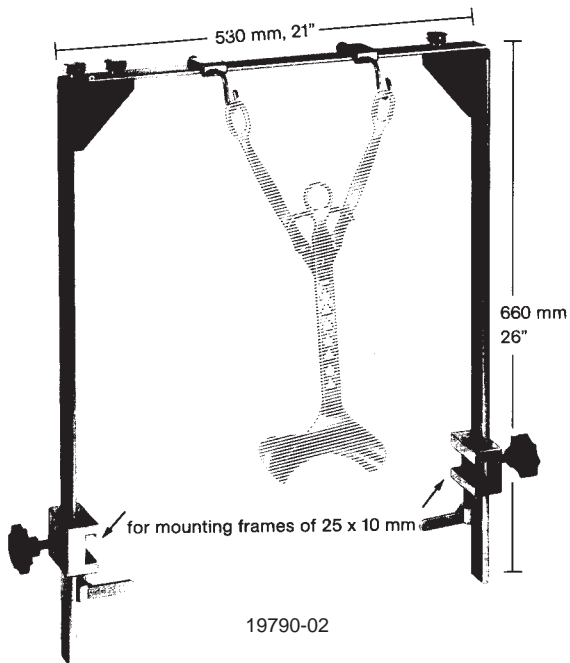

19790-02

Bauchdeckenhalter
Abdominal Retractors
Separadores abdominales
Divaricatori addominali

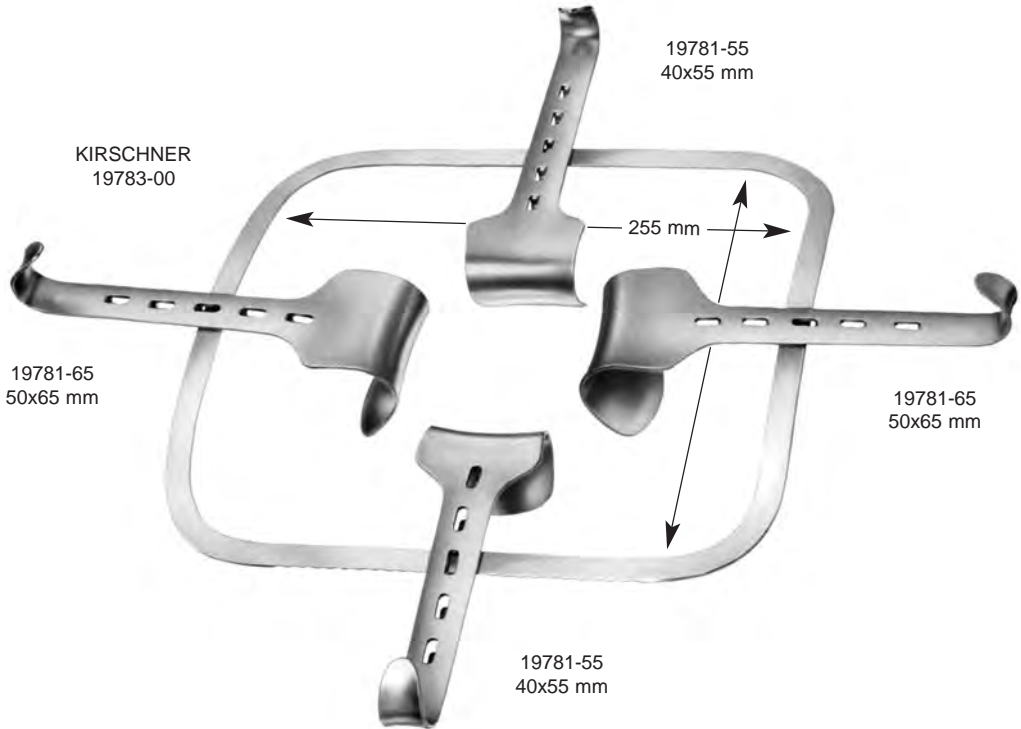

19783-01 250x250 mm
zusammenlegbarem Rahmen
holding frame
marco
telaio

Bauchdeckenhalter
 Abdominal Retractors
 Separadores abdominales
 Divaricatori addominali

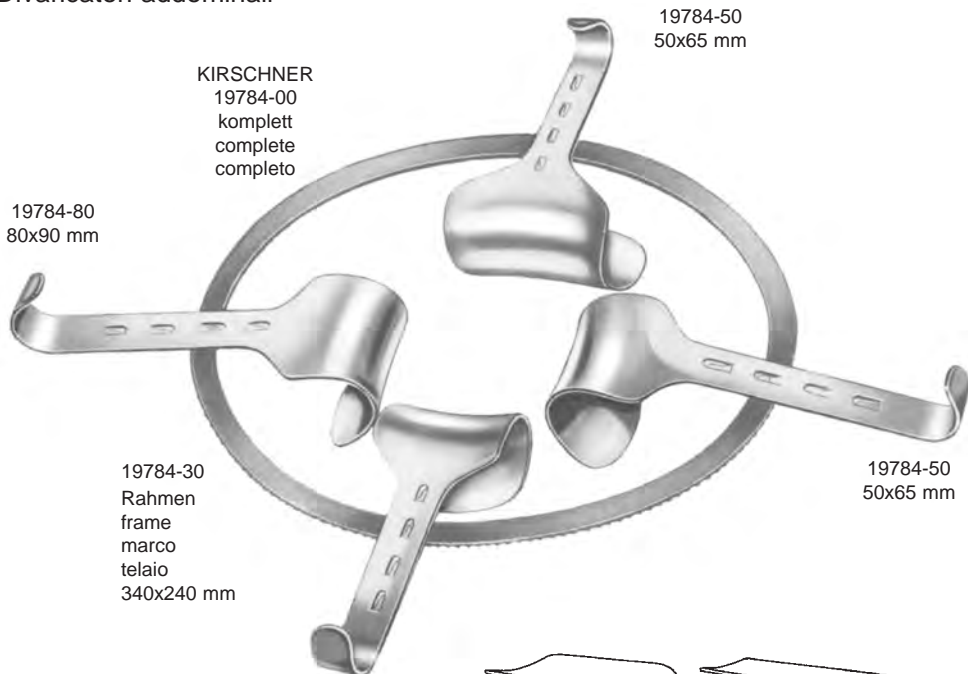

KIRSCHNER
 19784-00
 komplett
 complete
 completo

19784-50
 50x65 mm

19784-80
 80x90 mm

19784-30
 Rahmen
 frame
 marco
 telaio
 340x240 mm

19784-50
 50x65 mm

19784-80
 80x90 mm

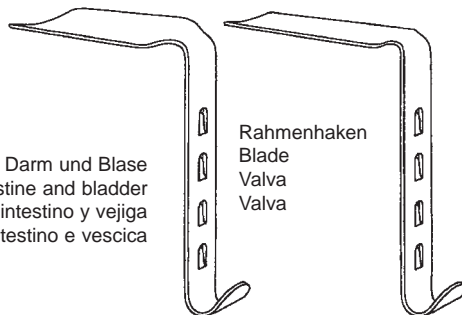

für Darm und Blase
 for intestine and bladder
 para intestino y vejiga
 per intestino e vescica

Rahmenhaken
 Blade
 Valva
 Valva

19784-98
 98x50 mm

19784-99
 105x35 mm

für adipöse Patienten
 for obese patients
 para pacientes obesos
 per pazienti obesi

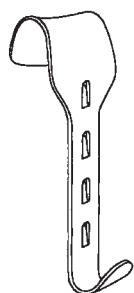

19784-40
 40x55 mm

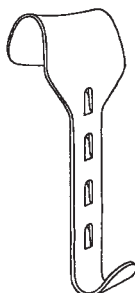

19784-50
 50x65 mm

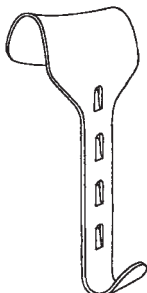

19784-60
 60x85 mm

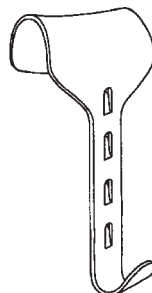

19784-78
 78x65 mm

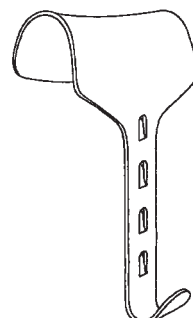

19784-80
 80x90 mm

Arm System
 Arm System
 Sistema de brazo
 Sistema braccio



19795-01
 Armsystem Radius 310/420 mm komplett mit Wundhakenhalter und U-Stativ Ø 16 mm, 400 mm hoch, 400 mm breit, 170 mm tief.
 Arm System, radius 310/420 mm, including retractor and U-stand Ø 16 mm, 400 mm high, 400 mm wide, 170 mm deep.



19795-02
 Armsystem Radius 310/420 mm komplett mit Stativ, Klemmsockel und Endoskophalter Ø 8/10 mm.
 Arm System, radius 310/420 mm, including stand, clamp, endoscope holder Ø 8/10 mm.



19798-01
 Einschlauchhalterung
 Single tube holder



19798-02
 Endoskophalterung Universal
 Ø 3-10 mm
 Endoscope holder Universal
 Ø 3-10 mm



19798-03
 Universelle
 Wundhakenhalterung
 Universal retractor holder

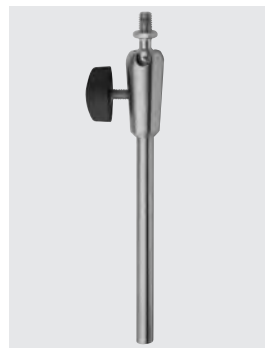

19798-04
 Gelenkverlängerung
 180 mm lang mit Feststellung
 Extended articulation
 180 mm long, lockable

Arm System
 Arm System
 Sistema de brazo
 Sistema braccio



19799-01

Klemmsocle aus rostfreiem Stahl, für ein höhenverstellbares Stativ Ø 16 mm, elektrisch isoliert bis 1,5 kV AC, Spannweite 35 mm für Schienen 25/32 x 8/12 mm.

Clamp socket made of stainless steel, for height-adjustable stand Ø 16 mm, electrically insulated up to 1.5 kV AC, holding width of 35 mm for rails 25/32 x 8/12 mm.



19799-02

Klemmsocle aus rostfreiem Stahl, für ein höhenverstellbares Stativ Ø 16 mm, elektrisch isoliert bis 1,5 kV AC, Spannweite 35 mm für Schienen 25/32 x 8/12 mm.

Clamp socket made of stainless steel, for height-adjustable stand Ø 16 mm, electrically insulated up to 1.5 kV AC, holding width of 35 mm for rails 25/32 x 8/12 mm.



19799-03

Leichtmetall-Klemmsocle Spannweite 35 mm, für ein Schraubstativ mit Ø 16 mm/M10, für Schienen 25/35 x 8/10 und Rohre Ø 12 - 35 mm. Clamp socket made of light metal, holding width 35 mm, for screw stand Ø 16 mm/M10, for rails 25/35 x 8/10 and tubes Ø 12 - 35 mm.



19799-04

Leichtmetall-Klemmsocle Spannweite 50 mm, für ein höhenverstellbares Stativ Ø 16 mm, für Schienen 25/35 x 8/10 und Rohre Ø 12 - 35 mm. Clamp socket made of light metal, holding width 50 mm, for height-adjustable stand Ø 16 mm, for rails 25/35 x 8/10 and tubes Ø 12 - 35 mm.



19799-05

Klemmsocle aus rostfreiem Stahl, für ein höhenverstellbares Stativ Ø 16 mm, elektrisch isoliert bis 4,5 kV AC, Spannweite 50 mm für Schienen 25/32 x 8/12 mm.

Clamp socket made of stainless steel, for height-adjustable stand Ø 16 mm, electrically insulated up to 4.5 kV AC, holding width of 50 mm for rails 25/32 x 8/12 mm.



19799-06

Leichtmetall-Klemmsocle Spannweite 50 mm, für ein Schraubstativ mit Ø 16 mm/M10, für Schienen 25/35 x 8/10 und Rohre Ø 12 - 35 mm. Clamp socket made of light metal, holding width 50 mm, for screw stand Ø 16 mm/M10, for rails 25/35 x 8/10 and tubes Ø 12 - 35 mm.

Bauchdeckenhalter, Wundsperrer
 Abdominal Retractors, Retractors
 Separadores abdominales, Separadores
 Divaricatori addominali, Divaricatori

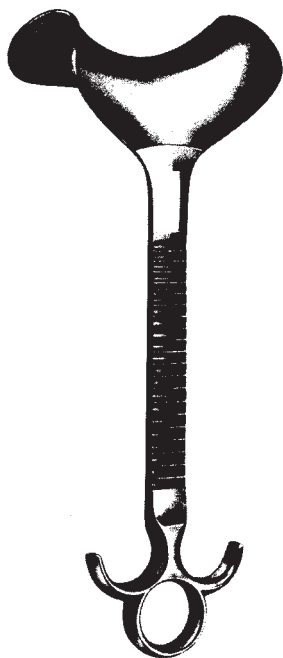

DOYEN

28 cm, 11"

19800-01 48x 90 mm
 19800-02 48x105 mm
 19800-03 48x120 mm
 19800-04 48x135 mm

< 100 mm >

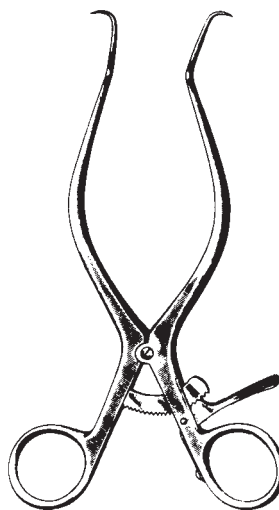

GELPI

19802-09 9 cm, 3 1/2"
 19802-11 11 cm, 4 3/8"
 19802-14 14 cm, 5 1/2"
 19802-16 16 cm, 6 1/4"
 19802-18 18 cm, 7"



DE BAKEY

19803-14

14,5 cm, 5 3/4"

Wundsperrer
Retractors
Separadores
Divaricatori

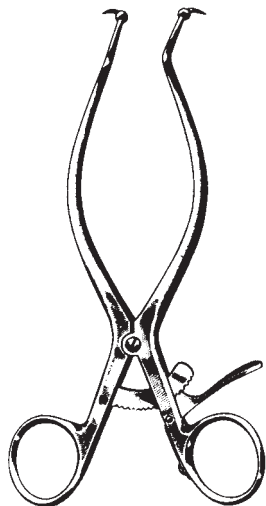

GELPI
19804-18
18 cm, 7"



JACKSON BURROWS
19805-18
18,5 cm, 7 1/4"

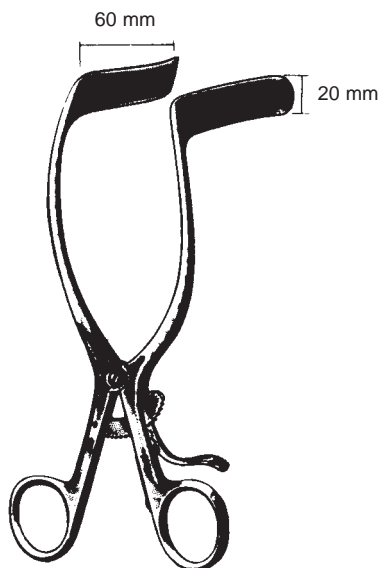

RIGBY
19806-18
18 cm, 7"

Bauchdeckenhalter
Abdominal Retractors
Separadores abdominales
Divaricatori addominali

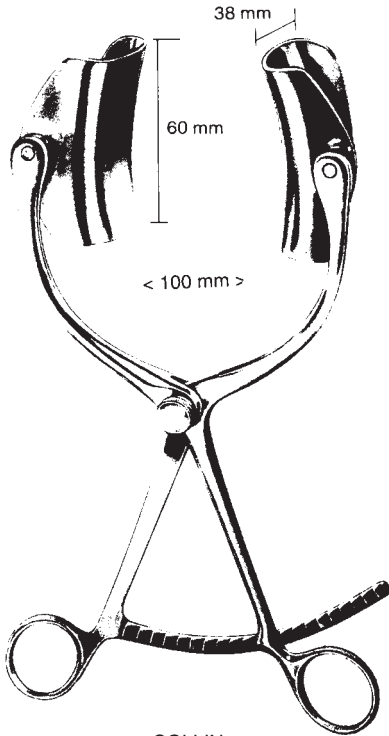

COLLIN
19810-22

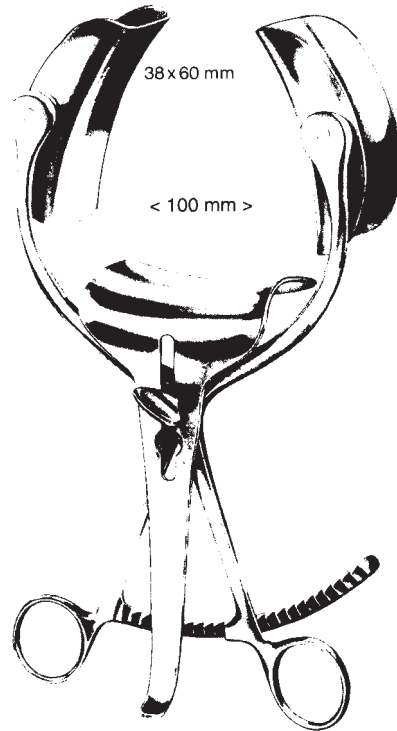

COLLIN
19812-60

Bauchdeckenhalter
 Abdominal Retractors
 Separadores abdominales
 Divaricatori addominali

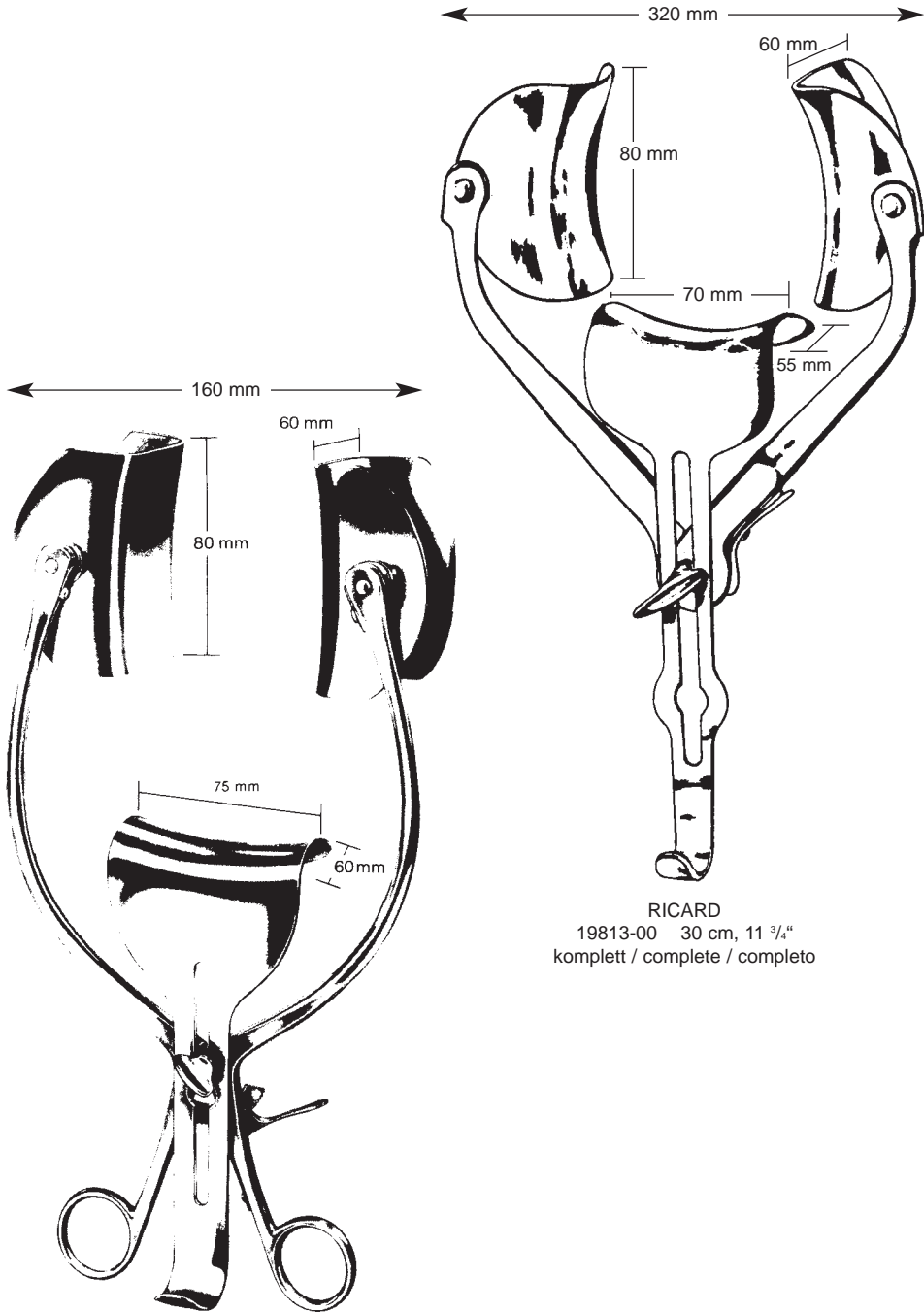

RICARD
 19813-00 30 cm, 11 3/4"
 komplett / complete / completo

COLLIN Loktite
 19816-00 31 cm, 12 1/4"
 komplett / complete / completo

Back holder Abdominal Retractor
Operation Table Set

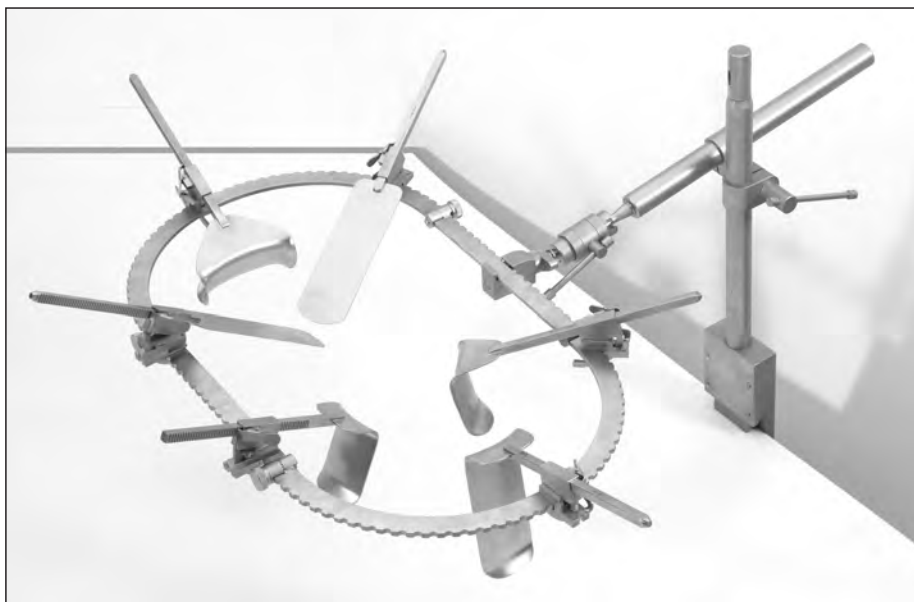

Complete Fixed Abdominal Retractor Set
Set completo divaricatore addominale con sistema di montaggio modulare

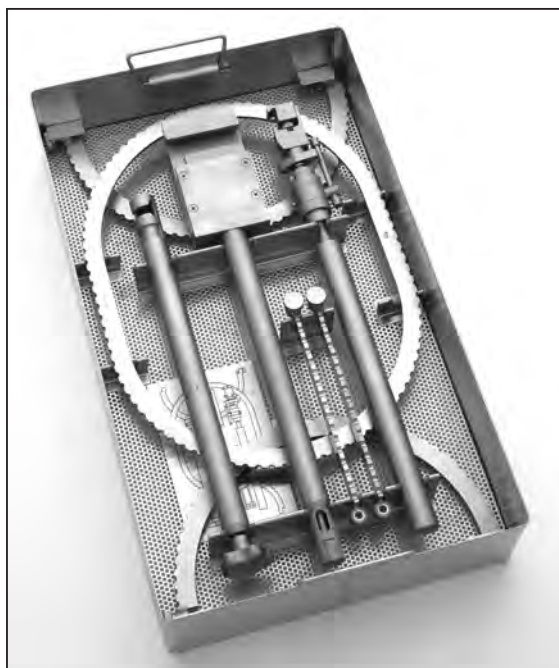

The many components of the **Back holder Abdominal Retractor Operation Table Set**

can all be neatly arranged into autoclave sized containers with diagrams that direct instrument handlers on proper placement of each component.

*A major convenience in care and maintenance
of the Retractor Set*

Sterilization Container & Baskets

Description	Product No
Table Fixation & Ring Case	19820-90
Blade & Accessories Case	19820-91

**Back holder Abdominal Retractor
Operation Table Set**

Description	Product No	<i>Composto da</i>	
Complete Abdominal Retractor Set	19820-99	Accoppiatore	19821-01
<i>Includes</i>		Barra orizzontale	19821-02
Table Post	19821-01	Morsetto di accoppiamento	19821-04
Horizontal Bar	19821-02	Anello ovale	19820-02
1" Post Coupling	19821-04	No. 2 retrattori malleabili, 51x152 mm	19825-06
Oval Ring	19820-02	No. 2 Valve Kelly, dim. 51x76 mm	19822-23
2" X 6" Malleable Retractor (2 ea)	19825-06	Valva Kelly	19822-24
2" X 3" Kelly Retractor (2 ea)	19822-23	Valva Balfour	19823-33
2" X 4" Kelly Retractor	19822-24	Morsetto trasportabile con trasporto ad intervallo progressivo di 2 mm	19820-10
Balfour Retractor	19833-33	Morsetto articolato multidisciplinare con funzione movimento assiale orizzontale e verticale	19820-20
Ratchet Mechanism (2 ea)	19820-10	Anello rotondo circolare, dimensione 226 mm	19820-01
Tilt Ratchet Mechanism (6 ea)	19820-20	Anello ovale 266x367 mm	19820-02
Segmented Ring	19820-03	Anello a segmento 266x495 mm	19820-03
1 1/2" X 6" Malleable Retractor	19824-06	Retrattore malleabile 38x152 mm	19824-06
3" x 6" Malleable Retractor	19826-06	Retrattore malleabile 76x152 mm	19826-06
2" X 5" Kelly Retractor	19822-25	Valva Kelly, 51x127 mm	19822-25
2" X 6" Kelly Retractor	19822-26	Valva Kelly, 51x152 mm	19822-26
Horizontal Flex Bar	19821-03	Barra flessibile orizzontale	19821-03
Harrington Retractor	19831-25	Retrattore Harrington 63x143 mm	19831-25
Gelpi Retractor	19834-01	Retrattore con punta Gelpi	19834-01
<i>Accessories</i>		<i>Accessori:</i>	
Table Fixation & Ring Case	19820-90	<i>Container vuoto in acciaio inox dotato con griglia interna</i>	
Blades & Accessories Case	19820-91	Descrizione	
		Container in acciaio inox dotato di griglia interna per Accessori di fissazione, anelli e barre	19820-90
		Container in acciaio inox dotato di griglia interna per morsetti e divaricatori	19820-91



Malleable Retractors with Protective Edge



Description	Product No
1 1/2" x 6" 38 x 152 mm	19824-06
2" x 6" 51 x 152 mm	19825-06
3" x 6" 76 x 152 mm	19826-06

Specialty Retractors

Description	Product No
Balfour Retractor 2 5/8" x 3" 67 x 76 mm	19833-33
Gelpi Point Retractor	19834-01



Harrington Retractors

Description	Product No
Blade 2.5" x 5 5/8" 63 x 143 mm	19831-25

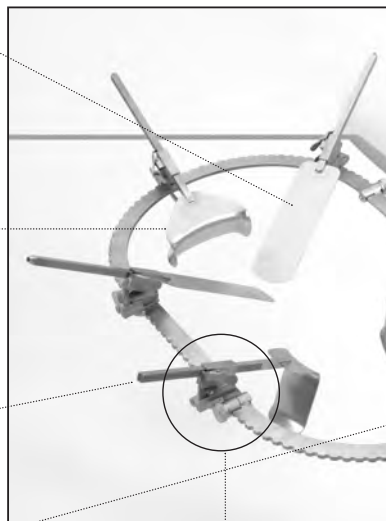

Description	Product No
Blade 2" x 1 1/2"	51 x 38 mm 19822-21
Blade 2" x 2"	51 x 51 mm 19822-22
Blade 2" x 2 1/2"	51 x 64 mm 19822-22L
Blade 2" x 3"	51 x 76 mm 19822-23
Blade 2" x 4"	51 x 102 mm 19822-24
Blade 2" x 5"	51 x 127 mm 19822-25
Blade 2" x 6"	51 x 152 mm 19822-26



Description	Product No
Blade 1" x 1 1/2" 25 x 38 mm	19822-01
Blade 1" x 2 1/2" 25 x 63 mm	19822-02



Tilt Ratchet Mechanism allows extensions or retractions along the horizontal axis and allows vertical movement of retractor blade with a second ratchet

Product No 19820-20

Table Mounting Components

Description	Product No
1" Post Coupler	19821-04

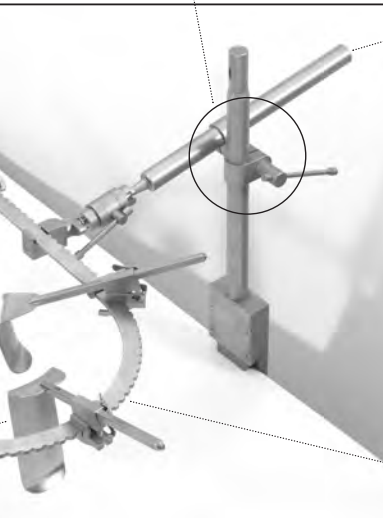

Table Mounting Components

Table Post	19821-01
Horizontal Bar	19821-02
Horizontal Flex Bar	19821-03



Fixed Ratchet Mechanism allows extension or retraction along the horizontal axis at 2mm intervals

Product No 19820-10



Retractor Rings

Description	Product No
Round Ring 10.5 inch / 266 mm	19820-01
Oval Ring 10.5 x 14.5 inch / 266 x 367 mm	19820-02
Segmented Ring 10.5 x 19.5 inch / 266 x 495 mm (Consists of one 10.5 inch Round Ring and two 8 inch straight segments)	19820-03

Laminektomiespreizer
Laminectomy Retractors
Separadores para laminectomia
Divaricatori per laminectomia



19910-00
SCOVILLE-HAVERFIELD
Rahmen allein
Frame only
Marco solo
Telaio solo



19911-00
SCOVILLE
Rahmen allein
Frame only
Marco solo
Telaio solo



SCOVILLE
50 mm, 2"
19912-50



SCOVILLE
70 mm, 2 3/4"
19912-70



SCOVILLE
19914-41 41 x 38 mm
19914-67 67 x 44 mm



TAYLOR
19915-48 48 x 50 mm
19915-64 64 x 50 mm
19916-64 64 x 64 mm
19916-80 80 x 57 mm



SCOVILLE
50 mm, 2"
19913-50



SCOVILLE
70 mm, 2 3/4"
19913-70



SCOVILLE
19917-64 64 x 25 mm
19918-64 64 x 50 mm
19918-88 88 x 25 mm

Wundhaken für plastische Chirurgie
 Retractors for plastic surgery
 Separadores para cirugía plástica
 Divaricatore per chirurgia plastica



TEBBETTS

19980-01	80 mm x 16 mm
19980-02	100 mm x 25 mm
19980-03	120 mm x 25 mm
19980-04	120 mm x 30 mm
19980-05	150 mm x 25 mm
19980-06	150 mm x 30 mm

mit Kaltlicht + Absaugung
 with cold light + aspiration
 con luz fria + aspiracion
 con luce fredda + aspirazione



FERRIERA

19960-01	80 mm x 16 mm
19960-02	100 mm x 25 mm
19960-03	120 mm x 25 mm
19960-04	120 mm x 30 mm
19960-05	150 mm x 25 mm
19960-06	150 mm x 30 mm

Wundhaken für plastische Chirurgie
 Retractors for plastic surgery
 Separadores para cirugía plástica
 Divaricatore per chirurgia plastica



19970-01
 37 x 70 mm
 22 x 54 mm

BREAST
 31 cm, 12 1/4"



CORONAL BLOW LIFT
 19980-18
 18 cm, 7"



YANCOSKIE
 19990-18
 18 cm, 7"



FREEMAN
 19995-38 18 cm, 7"
 38 mm, 1 1/2" wide

19995-22 18 cm, 7"
 22 mm, 7/8" wide



ANDERSON
 19998-03 12 cm, 4 3/4" 3 prong
 3 rebbi

19998-05 12 cm, 4 3/4" 5 prong
 5 rebbi

Sonden
Probes, Directors
Sondas, estiletes
Sonde, specilli



2 mm ø

11,5 cm, 4 1/2" 21102-11
13,0 cm, 5 1/8" 21102-13
14,5 cm, 5 3/4" 21102-14
16,0 cm, 6 1/4" 21102-16
18,0 cm, 7" 21102-18
20,0 cm, 8" 21102-20
25,0 cm, 10" 21102-25



1 mm ø

21104-11
21104-13
21104-14
21104-16
21104-18
21104-20
21104-25



2 mm ø

21106-11
21106-13
21106-14
21106-16
21106-18
21106-20
21106-25

 21108-14
14,5 cm, 5 3/4"

 BRODIE
21109-18
18 cm
7"

13,0 cm, 5 1/8" 21110-13
14,5 cm, 5 3/4" 21110-14
16,0 cm, 6 1/4" 21110-16
18,0 cm, 7" 21110-18
20,0 cm, 8" 21110-20

 DOYEN
21111-14
14 cm
5 1/2"

 21112-14
14,5 cm
5 3/4"

 STACKE
21115-10
10,5 cm
4.1"

 NELATON
21120-16
16 cm
6 1/4"

 FISH
21121-14
14 cm, 5 1/2"
21121-18
18 cm, 7"

 WATSON-CHEYNE
21122-13
13 cm, 5 1/8"
21122-18
18 cm, 7"

Fistelsonden
Fistula Probes
Sondas para fistula
Sonde per fistole



LOCKHART-MUMMERY
21125-01
16,5 cm, 6 1/2"

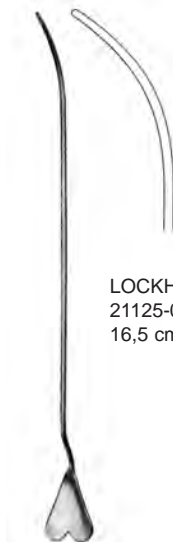

LOCKHART-MUMMERY
21125-02
16,5 cm, 6 1/2"



LOCKHART-MUMMERY
21125-03
16,5 cm, 6 1/2"

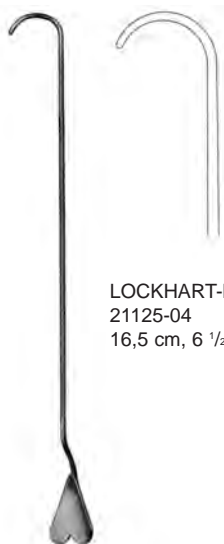

LOCKHART-MUMMERY
21125-04
16,5 cm, 6 1/2"

Krampfader-Besteck in Metalletui
 Varicose vein probe set in metal case
 Juego para várices en estuche de metal
 Astuccio per varici in scatola di metallo

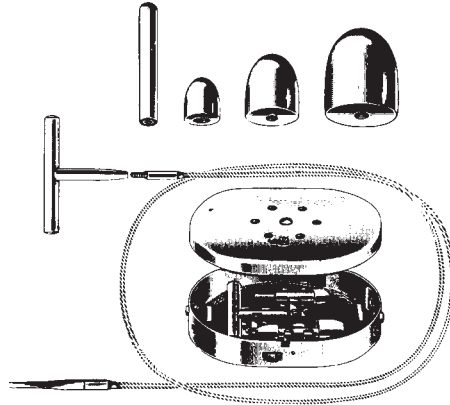

NABATOFF
 21150-00
 135x100x25 mm
 compl.

Ersatzteile
 Spare parts
 Piezas de repuesto
 Pezzi di ricambio

21150-02

21150-80

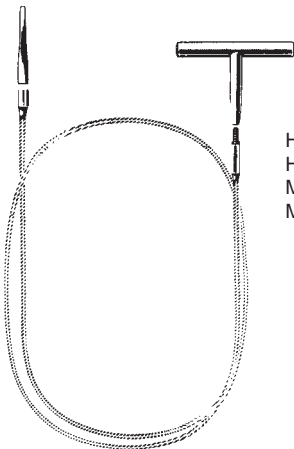

21150-90

Zugseil
 cable flexible
 cable de traccion flex.
 Corda di trazione fless.

Handgriff
 Handle only
 Mango suelto
 Manico solo



21150-03
 3 mm ø



21150-06
 6 mm ø



21150-09
 9 mm ø



21150-12
 12 mm ø



21150-15
 15 mm ø

Sondenspitzen
 Probe Tip
 Puntas sueltas
 Punte



Varizeninstrumente
 Varix Instruments
 Instrumentos para varices
 Strumenti per varici



VARADY
 21154-01
 180 mm, 7"



VARADY
 21154-02
 180 mm, 7"



VARADY
 21154-03
 180 mm, 7"



VARADY
 21154-04
 175 mm, 6.9"



VARADY
 21154-05
 170 mm, 6 3/4"



VARADY
 21154-06
 170 mm, 6 3/4"

21162-12
 12 cm, 4 3/4"
 Griff
 Handle
 Mango
 Manico



21160-04
 -
 21160-14

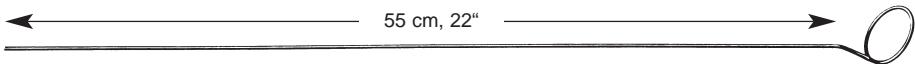

21160-04
 4 mm ø



21160-06
 6 mm ø



21160-07
 7 mm ø



21160-08
 8 mm ø



21160-10
 10 mm ø

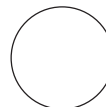

21160-12
 12 mm ø

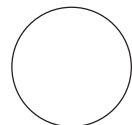

21160-14
 14 mm ø

Watteträger, Spatel
 Cotton Applicators, Spatulas
 Porta-algodones, Espátulas
 Portacotone, Spatole



FARRELL

4 3/4"	21270-12	12,0 cm
5 1/2"	21270-14	14,0 cm
6 1/2"	21270-16	16,5 cm
7"	21270-18	18,0 cm
9"	21270-23	23,0 cm



FARRELL

4 3/4"	21272-12	12,0 cm
5 1/2"	21272-14	14,0 cm
6 1/4"	21272-16	16,5 cm
7"	21272-18	18,0 cm
9"	21272-23	23,0 cm



REDA

4 3/4"	21290-12	12,0 cm
5 1/2"	21290-14	14,0 cm
6 1/4"	21290-16	16,0 cm
7"	21290-18	18,0 cm



1,5



1,5

REDA

4 3/4"	21292-12	12,0 cm
5 1/2"	21292-14	14,0 cm
6 1/4"	21292-16	16,0 cm
7"	21292-18	18,0 cm

Spatel
 Plaster spatula
 Espátula
 Spatole



21190-14
 14,5 cm, 5 3/4"



UCKERMANN
 21310-15
 15 cm, 6"



JOBSON-HORNE
 21320-12 12 cm, 4 3/4"
 21320-18 18 cm, 7"



TOBOLD
 21331-25
 25 cm, 10"



21340-45
 45 cm, 17 3/4"

Trokare
Trocars
Trócares
Trequarti

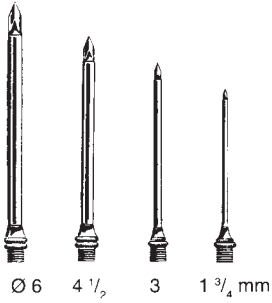

UNIVERSAL
23104-00
compl.



STANDARD (Nelson)

23110-30	3,0 mm ø
23110-35	3,5 mm ø
23110-40	4,0 mm ø
23110-45	4,5 mm ø
23110-50	5,0 mm ø
23110-55	5,5 mm ø
23110-60	6,0 mm ø

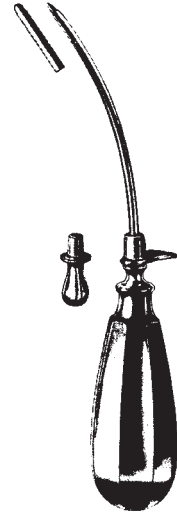

PIERCE

23123-30	3,0 mm Ø
23123-40	4,0 mm Ø
23123-50	5,0 mm Ø



DOUGLAS
23125-11 3 mm Ø

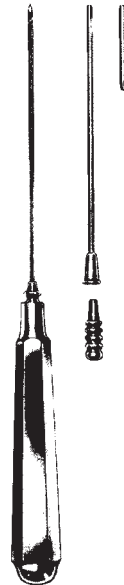

LICHTWITZ
23128-19 1,75 mm Ø

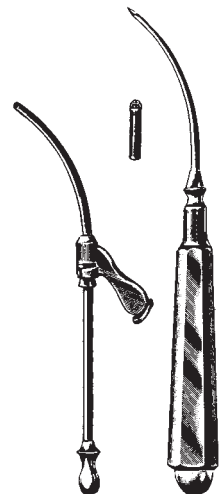

COAKLEY
23140-02 2,25 mm Ø

Trokare
Trocars
Trócares
Trequarti

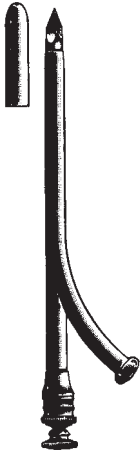

Charr./	
F.G.	OCHSNER
10	23150-10
12	23150-12
14	23150-14
16	23150-16
18	23150-18
20	23150-20



Charr./		
F.G.	NELSON	Ø
25	23170-25	7,5 mm
30	23170-30	9,0 mm
33	23170-33	10,5 mm
35	23170-35	12,0 mm



SINOSKOPIE-TROKAR
universal
8,5 cm, 3.4"

23180-27 f. Optik mit Ø 2,7 mm
23180-40 f. Optik mit Ø 4,0 mm



SINOSKOPIE-TROKAR
abgeschrägt/oblique beak
8,5 cm, 3.4"

23181-40 f. Optik mit Ø 4,0 mm



Biopsiekanülen
Biopsy Needles
Agujas para biopsia
Aghi per biopsia

Nadelführer
Pudendus
Anesthésie
anestesia



IOWA
23210-00
compl.



VERRES
23250-20 2,00x100 mm
23250-40 2,00x140 mm

Pneumoperitoneum
Pneumoperitoneum
Neumoperitoneo
Pneumoperitoneo



MENGHINI
23302-01 1,0x 35 mm
23302-02 1,0x 70 mm
23302-03 1,2x 70 mm
23302-04 1,2x100 mm
23302-05 1,4x 70 mm
23302-06 1,4x100 mm
23302-07 1,6x 70 mm
23302-08 1,8x100 mm



MENGHINI
23310-14 1,4x168 mm
23310-18 1,8x168 mm

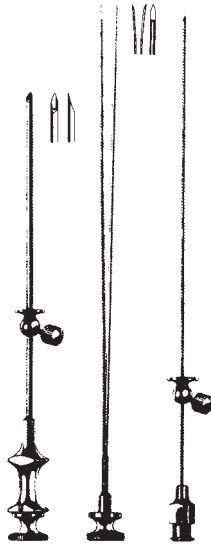

FRANKLIN-SILVERMANN
23330-20 2,0x105 1,5x155
23330-14 2,0x130 1,5x180
compl.

Biopsienadel
Biopsy needle
Aguja para biopsia
Ago per biopsia

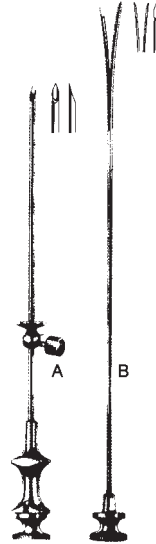

Spaltnadel
Bifurcated
Aguja bifurcada
Ago biforcato

FRANKLIN-SILVERMANN
A ø mm B ø mm A+B
23351-20 2,0x100 23352-15 1,5x150 23350-20
23351-30 2,5x145 23352-20 2,0x195 23350-30

Führungsnadeln
 Guide needles
 Aguja de Guía
 Ago guida

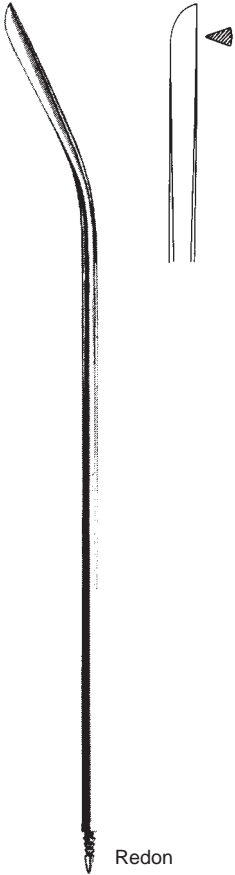

Redon

23195-08 - 23195-18

Führungsnadel, gerade
 Guide Needle, straight
 Aguja de guía, recta
 Ago guida, retta

Charr./Fr.
 8 23195-08
 10 23195-10
 12 23195-12
 14 23195-14
 16 23195-16
 18 23195-18



Redon

23197-08 - 23197-18

Führungsnadel, gebogen
 Guide Needle, curved
 Aguja de guía, curva
 Ago guida, curva

Charr./Fr.
 8 23197-08
 10 23197-10
 12 23197-12
 14 23197-14
 16 23197-16
 18 23197-18

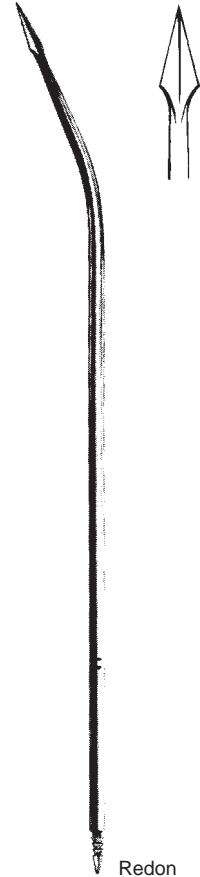

Redon

23198-08 - 23198-18

Führungsnadel, Lanzettspitze
 Guide Needle, with lancet tip
 Aguja de guía, con punta lanceolar
 Ago guida, con punta lanceolata

Charr./Fr.
 8 23198-08
 10 23198-10
 12 23198-12
 14 23198-14
 16 23198-16
 18 23198-18

Nadelhalter
Needle Holders
Porta-agujas
Port'aghi

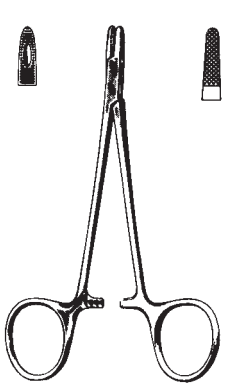

DERF
25110-12
12 cm, 4 $\frac{3}{4}$ "
25114-12 TC
12 cm, 4 $\frac{3}{4}$ "

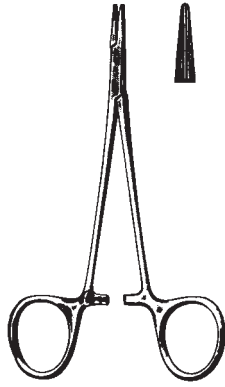

DERF
25120-12
12,5 cm, 5"

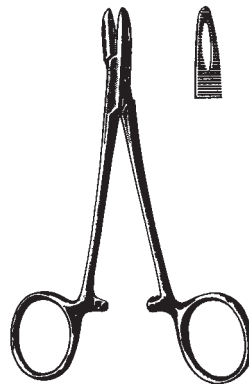

COLLIER
25122-12
12,5 cm, 5"

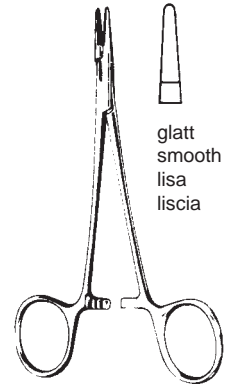

glatt
smooth
lisa
liscia

WEBSTER
25128-13
13 cm, 5 $\frac{1}{8}$ "
25129-13 TC
13 cm, 5 $\frac{1}{8}$ "

BABY-WEBSTER
25136-11
11 cm, 4 $\frac{3}{8}$ "
25137-11 TC
11 cm, 4 $\frac{3}{8}$ "

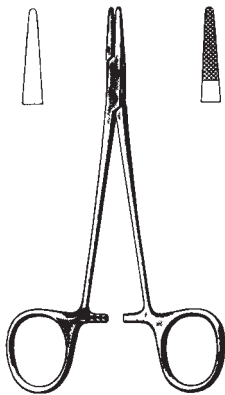

HALSEY
25130-13 25140-13
25134-13 TC 25144-13 TC
13 cm, 5 $\frac{1}{8}$ "

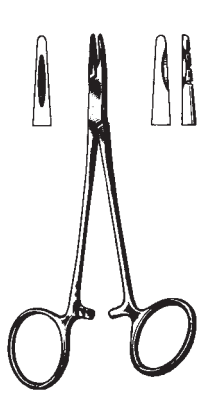

NEIVERT
25146-13
13 cm, 5 $\frac{1}{8}$ "

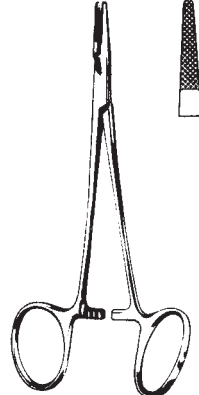

NEIVERT
25148-13 TC
13 cm, 5 $\frac{1}{8}$ "

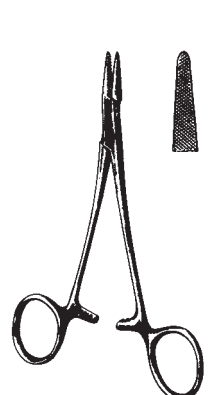

BAUMGARTNER
25150-12 25154-12 TC
12,5 cm, 5"
25150-14 25154-14 TC
14,0 cm, 5 $\frac{1}{2}$ "

Nadelhalter
Needle Holders
Porta-agujas
Port'aghi

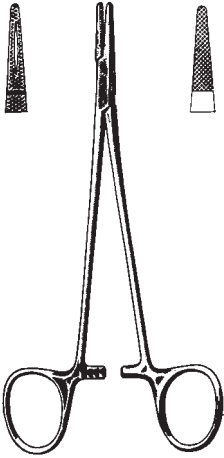

CRILE-WOOD

- | | | |
|----------|-----------|-------------|
| 25160-15 | 15 cm, 6" | 25164-15 TC |
| 25160-18 | 18 cm, 7" | 25164-18 TC |
| 25160-20 | 20 cm, 8" | 25164-20 TC |
| 25160-23 | 23 cm, 9" | 25164-23 TC |



CRILE-MURRAY

- | | |
|----------|-------------|
| 25170-15 | 25174-15 TC |
| | 15 cm, 6" |

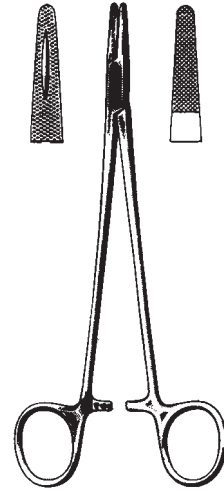

MAYO-HEGAR

- | | | |
|----------|----------------|-------------|
| 25180-12 | 12 cm, 4 3/4" | 25184-12 TC |
| 25180-14 | 14 cm, 5 1/2" | 25184-14 TC |
| 25180-16 | 16 cm, 6 1/4" | 25184-16 TC |
| 25180-18 | 18 cm, 7" | 25184-18 TC |
| 25180-20 | 20 cm, 8" | 25184-20 TC |
| 25180-24 | 24 cm, 9 1/2" | 25184-24 TC |
| 25180-26 | 26 cm, 10 1/4" | 25184-26 TC |
| 25180-30 | 30 cm, 11 3/4" | 25184-30 TC |

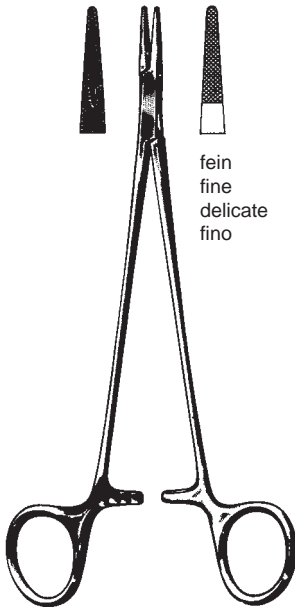

fein
fine
delicate
fino

MAYO-HEGAR

- | | | |
|----------|---------------|-------------|
| 25190-16 | 16 cm, 6 1/4" | 25194-16 TC |
| 25190-18 | 18 cm, 7" | 25194-18 TC |
| 25190-20 | 20 cm, 8" | 25194-20 TC |

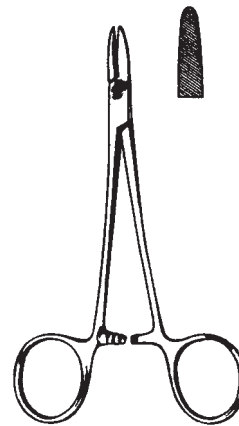

BROWN

- | | |
|----------|---------------|
| 25196-13 | 13 cm, 5 1/8" |
| 25196-18 | 18 cm, 7" |

Nadelhalter
Needle Holders
Porta-agujas
Port'aghi



DE BAKEY

25214-16 TC	16 cm, 6 1/4"
25214-18 TC	18 cm, 7"
25214-20 TC	20 cm, 8"
25214-23 TC	23 cm, 9"
25214-26 TC	26 cm, 10 1/4"
25214-31 TC	31 cm, 12 1/4"



RYDER 1 mm

25224-13 TC	13 cm, 5 1/8"
25224-15 TC	15 cm, 6"
25224-18 TC	18 cm, 7"
25224-20 TC	20 cm, 8"
25224-23 TC	23 cm, 9"
25224-26 TC	26 cm, 10 1/4"

RYDER 2 mm

25225-13 TC	
25225-15 TC	
25225-18 TC	
25225-20 TC	
25225-23 TC	
25225-26 TC	

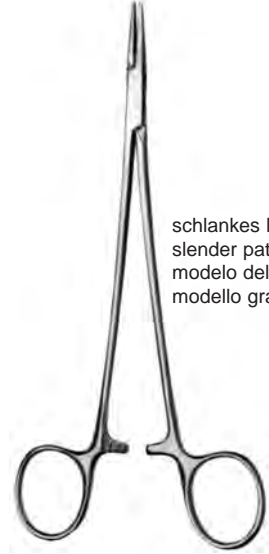

schlankes Modell
slender pattern
modelo delgado
modello gracile

MICROVASCULAR

25230-18 TC	18 cm, 7"
25230-20 TC	20 cm, 8"
25230-23 TC	23 cm, 9"

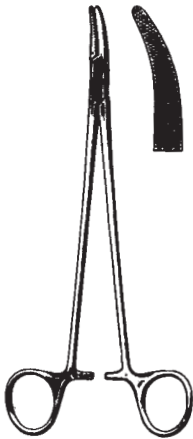

HEANEY

25241-21	21 cm, 8 1/4"
25241-26	26 cm, 10 1/4"
25245-21 TC	21 cm, 8 1/4"
25245-26 TC	26 cm, 10 1/4"

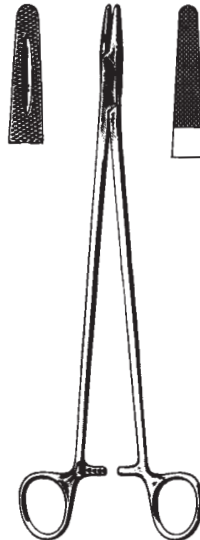

MASSON

25250-27	27 cm, 10 1/2"
25254-27 TC	27 cm, 10 1/2"



WANGENSTEEN

25260-27	27 cm, 10 1/2"
25264-27 TC	27 cm, 10 1/2"

Nadelhalter
Needle Holders
Porta-agujas
Port'aghi

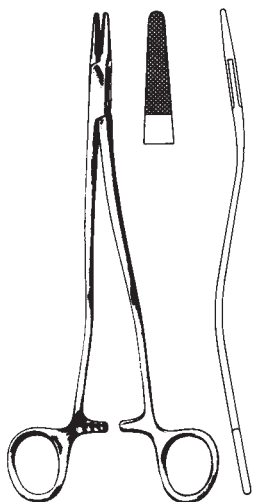

BOZEMANN

- 25285-20 TC 20 cm, 8"
- 25285-24 TC 24 cm, 9 1/2"
- 25285-26 TC 26 cm, 10 1/4"

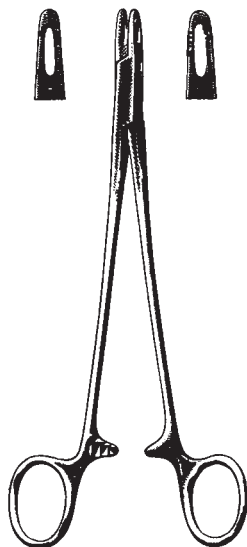

METZENBAUM

- 25290-18
- 18 cm, 7"

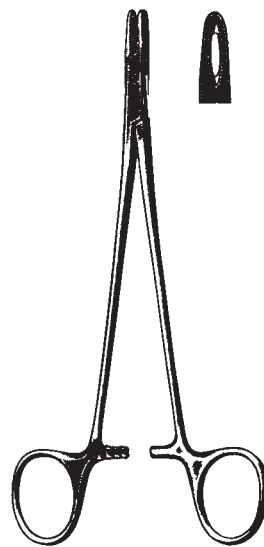

ADSON

- 25292-18
- 18 cm, 7"

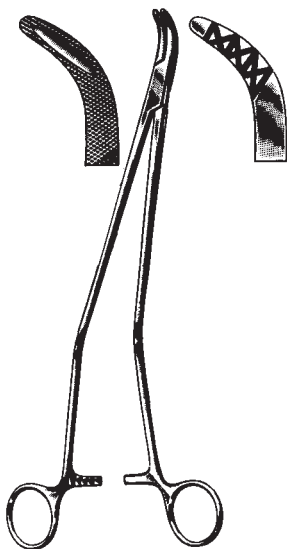

JOHNSON

- 25293-27
- 27 cm, 10 1/2"



FINOCHIETTO

- 25311-20 20 cm, 8"
- 25311-27 27 cm, 10 1/2"
- 25315-20 TC
- 25315-27 TC



SAROT

- 25324-18 TC 18 cm, 7"
- 25324-26 TC 26 cm, 10 1/4"

Nadelhalter
Needle Holders
Porta-agujas
Port'aghi

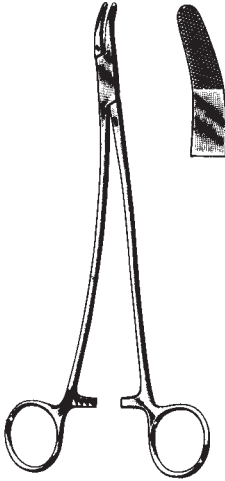

STRATTE
25330-21 21 cm, 8 1/4"
25330-23 23 cm, 9" **25334-23 TC**

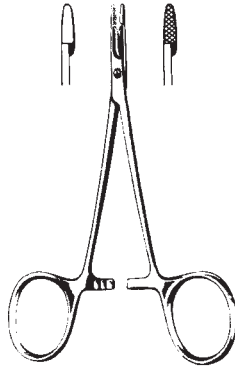

BABY-OLSEN-HEGAR
25405-12 25406-12
25408-12 TC 25407-12 TC
11,5 cm, 4 1/2"

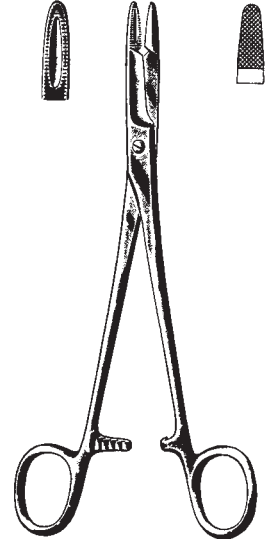

OLSEN-HEGAR
25410-14 14 cm, 5 1/2" **25414-14 TC**
25410-17 17 cm, 6 3/4" **25414-17 TC**
18 cm, 7" **25414-18 TC**



MATHIEU-OLSEN
25415-14 TC 14 cm, 5 1/2"
25415-17 TC 17 cm, 6 3/4"
25415-20 TC 20 cm, 8"

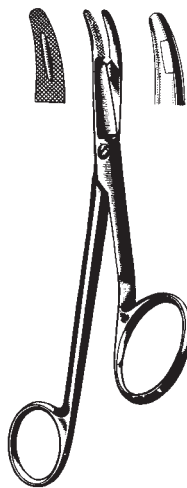

GILLIES
25430-16 11 cm, 4 3/8"
13 cm, 5 1/8"
16 cm, 6 1/4" **25434-11 TC**
25434-13 TC
25434-16 TC

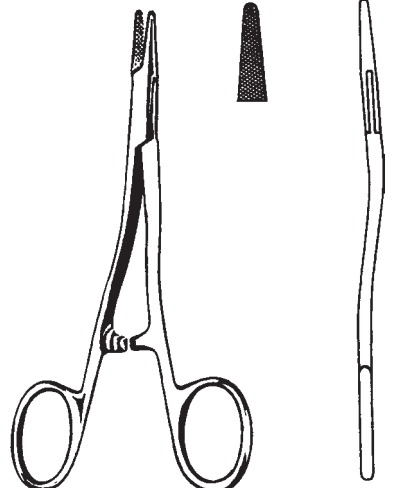

KILNER
25436-13 13 cm, 5 1/8"
25438-13 TC 13 cm, 5 1/8"

Nadelhalter
Needle Holders
Porta-agujas
Port'aghi

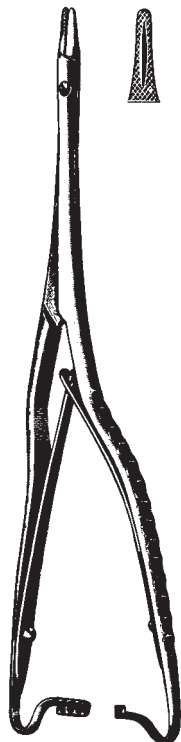

HOESEL

25446-25 25 cm, 10"
25447-25 TC 25 cm, 10"



CRILE

25438-15 15 cm, 6"

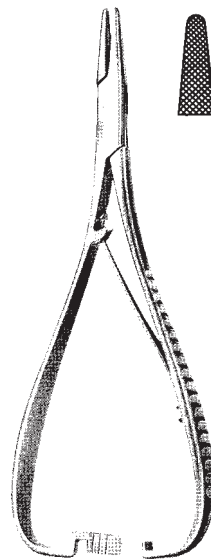

MATHIEU

25450-14 14 cm, 5 1/2" 25452-14 TC
25450-17 17 cm, 6 3/4" 25452-17 TC
25450-20 20 cm, 8" 25452-20 TC
25450-24 24 cm, 9 1/2" 25452-24 TC

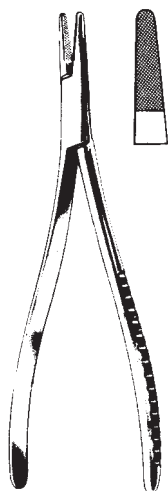

LANGENBECK

25460-18 TC 18 cm, 7"
25460-20 TC 20 cm, 8"
25460-23 TC 23 cm, 9"

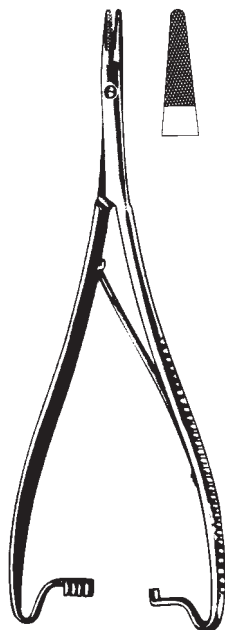

HOESEL

25465-20 TC 20 cm, 8"
25465-25 TC 25 cm, 10"



LICHTENBERG

25466-17 17 cm, 6 3/4" 25467-17 TC
25466-20 20 cm, 8" 25467-20 TC

Nadelhalter
Needle Holders
Porta-agujas
Port'aghi

Oftalmologie
Ophthalmology
Oftalmologia
Oftalmologia



STEVENS
25610-11
11 cm, 4 3/8"



STEVENS
25612-13 13 cm, 5 1/8"
25612-15 15 cm, 6"

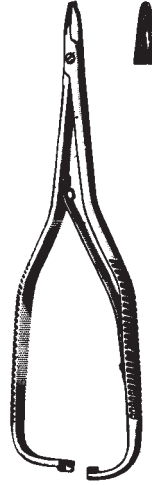

BOYNTON
25614-12
12 cm, 4 3/4"

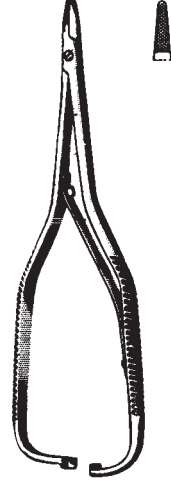

BOYNTON
25615-12 TC
12 cm, 4 3/4"



ARRUGA
25620-16 - 25624-16 TC - 25625-16 TC
16 cm, 6 1/4"

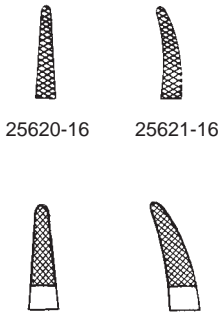

25620-16 25621-16
25624-16 TC 25625-16 TC

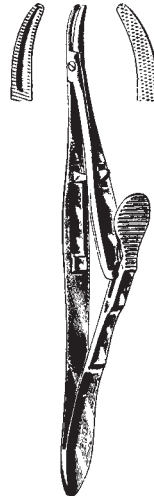

KALT-ARRUGA
25627-14
14 cm, 5 1/2"

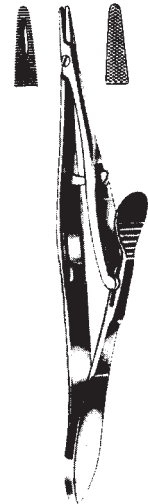

KALT
25628-14
14 cm, 5 1/2"

Nadelhalter
Needle Holders
Porta-agujas
Port'aghi

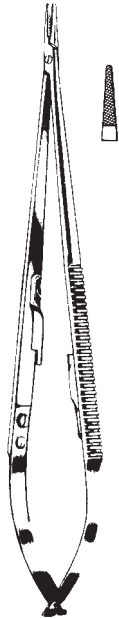

JACOBSEN
25667-18 18 cm, 7"
25668-18 TC 18 cm, 7"
25667-21 21 cm, 8 1/4"
25668-21 TC 21 cm, 8 1/4"

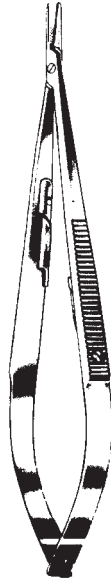

CASTROVIEJO
14 cm, 5 1/2"



25670-14
glatt
smooth
lisa
liscia



25672-14
gerieft
serrated
estriada
zigrinato



25676-14 TC



25671-14
glatt
smooth
lisa
liscia



25673-14
gerieft
serrated
estriada
zigrinato



25677-14 TC



25678-09



CASTROVIEJO-MICRO
9 cm, 3 1/2"



25679-09



CASTROVIEJO
25680-13 13 cm, 5 1/8"
25684-13 TC 13 cm, 5 1/8"

Mikro-Nadelhalter
 Micro-Needle Holders
 Micro-Porta-agujas
 Micro-Port'aghi



CASTROVIEJO-STANDARD
 25678-14 14 cm, 5 1/2"



CASTROVIEJO-STANDARD
 25679-14 14 cm, 5 1/2"

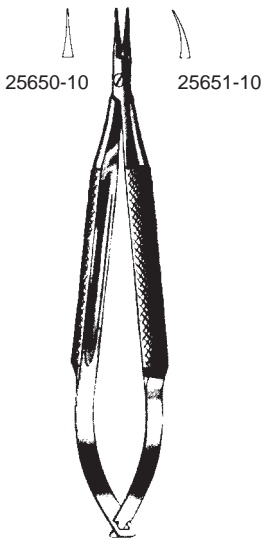

BARRAQUER
 10 cm, 4"



BARRAQUER-TROUTMAN
 10 cm, 4"

Mikro-Nadelhalter
Micro-Needle Holders
Micro-Porta-agujas
Micro-Port'aghi



BARRAQUER
13 cm, 5 1/8"

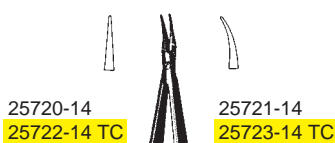

BARRAQUER
14 cm, 5 1/2"

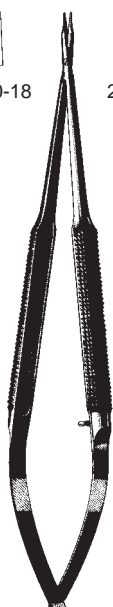

BARRAQUER
18 cm, 7"



BARRAQUER
18 cm, 7"

Unterbindungsnadeln
 Ligature Needles
 Aguja para ligaduras
 Aghi per legature



biegsam
 malleable
 maleable
 malleabile

27109-20

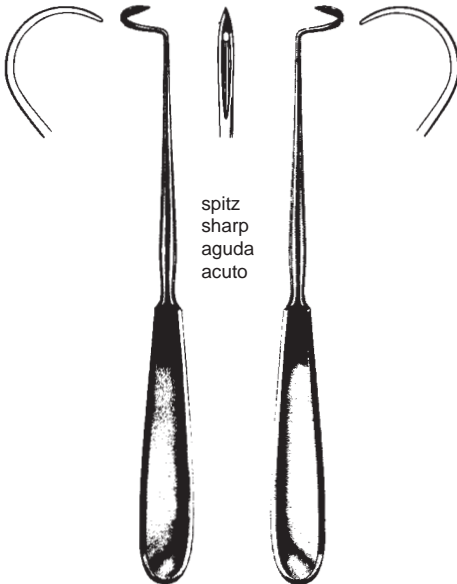

spitz
 sharp
 aguda
 acuto

	L	DESCHAMPS	R
	27110-21	21 cm, 8 1/4"	27111-21
	27110-24	24 cm, 9 1/2"	27111-24
	27110-27	27 cm, 10 1/2"	27111-27

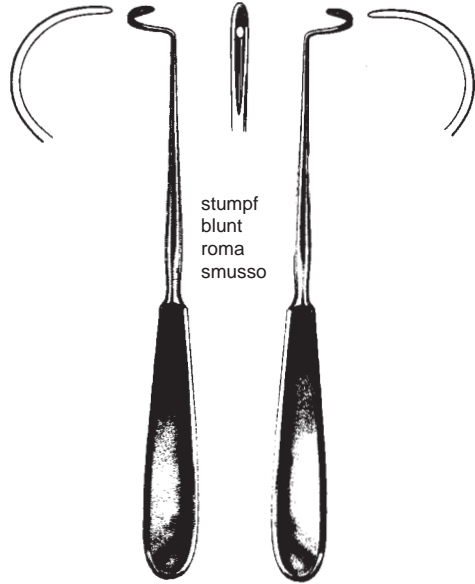

stumpf
 blunt
 roma
 smusso

	L	DESCHAMPS	R
	27120-21	21 cm, 8 1/4"	27121-21
	27120-24	24 cm, 9 1/2"	27121-24
	27120-27	27 cm, 10 1/2"	27121-27

Unterbindungsnadeln
 Ligature Needles
 Agujas para ligaduras
 Aghi per legature

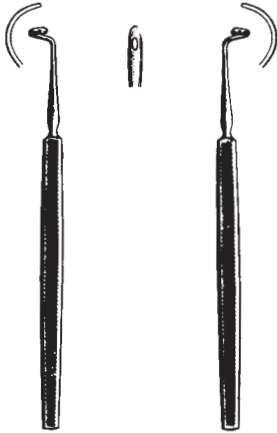

L KRONECKER R
 27130-13 27131-13
 13 cm, 5 1/8"



L NELSON R
 27133-24 27135-24
 24,5 cm, 9 3/4"



SCHMIEDEN-DICK
 27134-32 32 cm, 12 3/4"

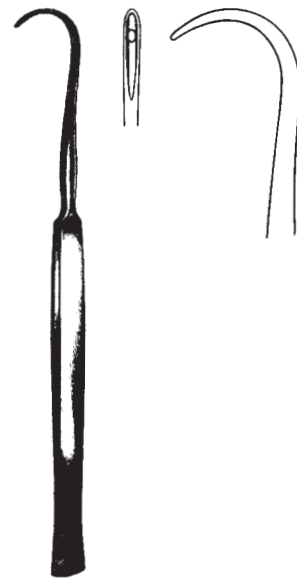

COOPER
 27139-19 19 cm, 7 1/2"

Nahtinstrumente
Suturing Instruments
Instrumentos para suturas
Strumenti per suture

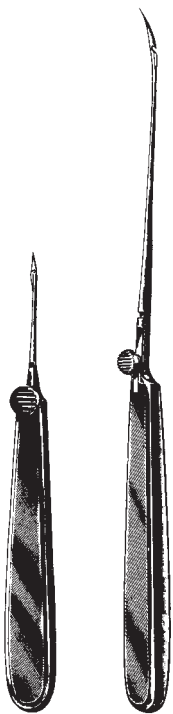

REVERDIN
27201-15 - 27204-21



Fig. 1

27201-15 15 cm, 6"
27201-19 19 cm, 7 1/2"
27201-21 21 cm, 8 1/4"



Fig. 2

27202-15 15 cm, 6"
27202-19 19 cm, 7 1/2"
27202-21 21 cm, 8 1/4"



Fig. 3

27203-15 15 cm, 6"
27203-19 19 cm, 7 1/2"
27203-21 21 cm, 8 1/4"



Fig. 4

27204-15 15 cm, 6"
27204-19 19 cm, 7 1/2"
27204-21 21 cm, 8 1/4"



YOUNG BOOMERANG
27240-00
25 cm, 10"



Fig. 1
27240-01



Fig. 2
27240-02

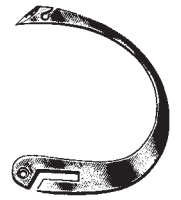
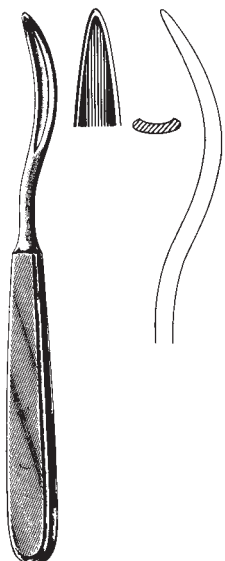
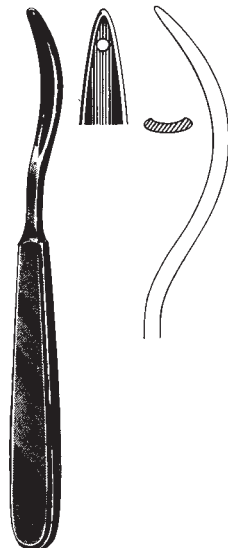

Fig. 3
27240-03

Führungshohlsonden
Ligature Conductors
Sondas conductoras
Sonde conduttrici



SCHMIEDEN
27271-19
19 cm, 7 1/2"



SCHMIEDEN-PAYR
27273-19
19 cm, 7 1/2"

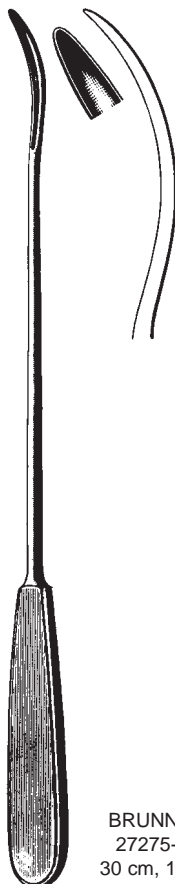

BRUNNER
27275-30
30 cm, 11 3/4"

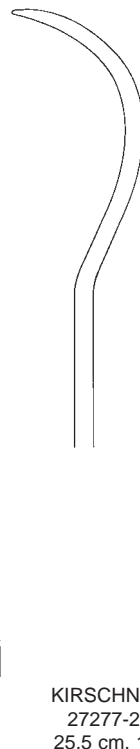

KIRSCHNER
27277-25
25,5 cm, 10"

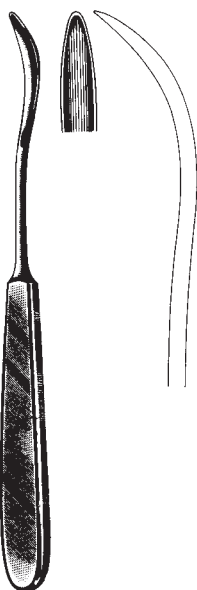

KOENIG
27285-20
20 cm, 8"



PAYR
27288-22
22 cm, 8 3/4"



PAYR
27289-22
22 cm, 8 3/4"

Plastik
plastic
plástico



BRUNNER
27291-18 18 cm, 7"
27291-27 27 cm, 10 1/2"



VIENNA
27297-23
23,5 cm, 9 1/4"



REDA
27298-23
23 cm, 9"

Chirurgische Nadeln
Suturing Needles
Agujas para suturas
Aghi per suture

Pack à 1 Dutzend
in packages of 1 dozen
en sobres de 1 docena
confezione 1 dozzina

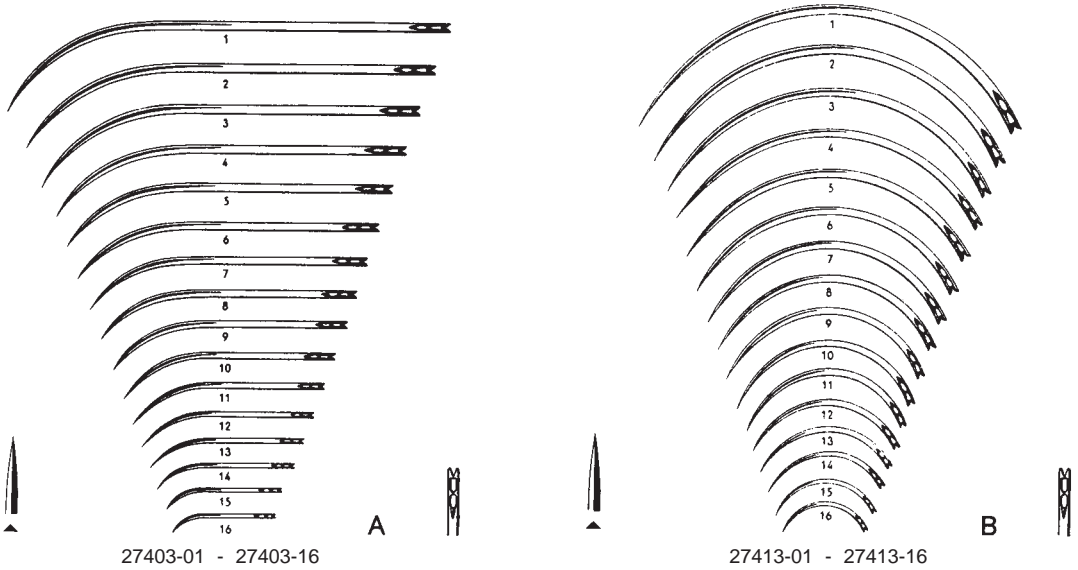
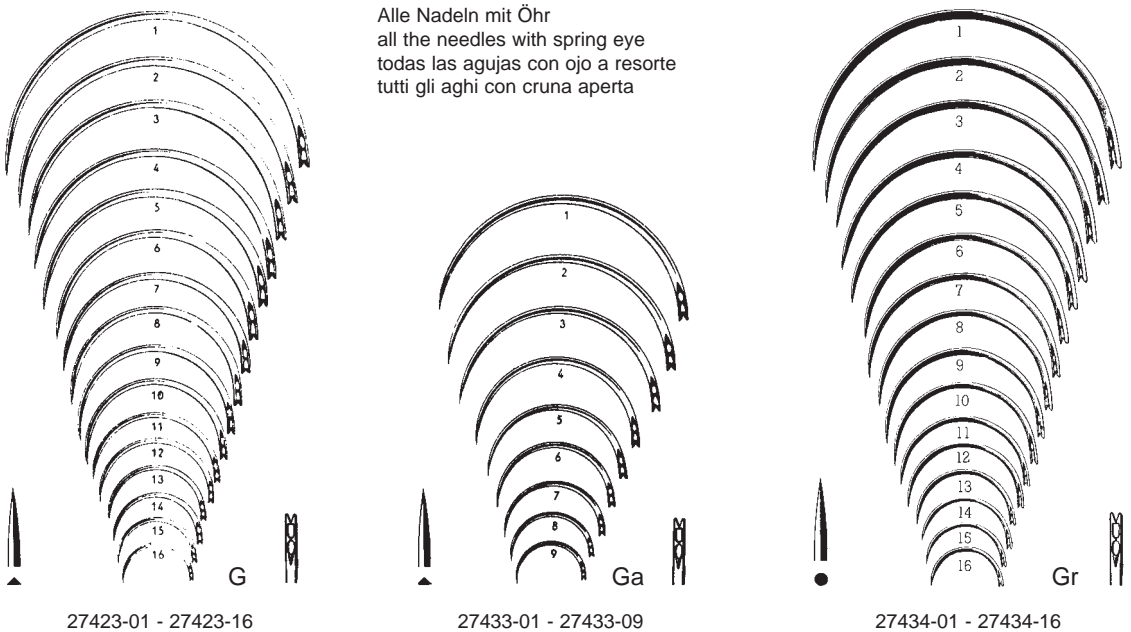
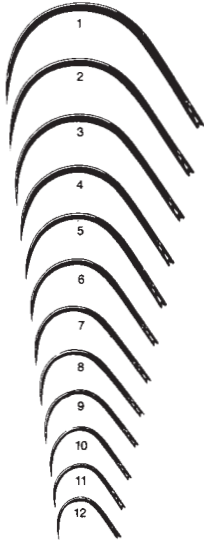

Fig. 1 2 3 4 5 6 7 8 9 10 11 12 13 14 15 16
 A 27403-01 27403-02 27403-03 27403-04 27403-05 27403-06 27403-07 27403-08 27403-09 27403-10 27403-11 27403-12 27403-13 27403-14 27403-15 27403-16
 B 27413-01 27413-02 27413-03 27413-04 27413-05 27413-06 27413-07 27413-08 27413-09 27413-10 27413-11 27413-12 27413-13 27413-14 27413-15 27413-16
 G 27423-01 27423-02 27423-03 27423-04 27423-05 27423-06 27423-07 27423-08 27423-09
 Ga 27433-01 27433-02 27433-03 27433-04 27433-05 27433-06 27433-07 27433-08 27433-09 27433-10 27433-11 27433-12 27433-13 27433-14 27433-15 27433-16
 Gr 27434-01 27434-02 27434-03 27434-04 27434-05 27434-06 27434-07 27434-08 27434-09 27434-10 27434-11 27434-12 27434-13 27434-14 27434-15 27434-16



Alle Nadeln mit Öhr
 all the needles with spring eye
 todas las agujas con ojo a resorte
 tutti gli aghi con cruna aperta

Chirurgische Nadeln
 Suturing Needles
 Agujas para suturas
 Aghi per suture



27441-01 - 27441-12

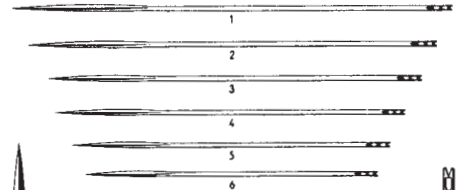

KEITH
 27450-01 - 27450-06

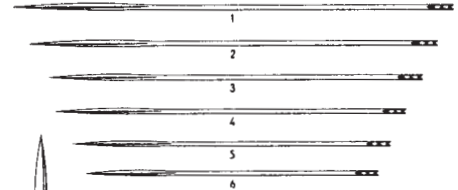

KEITH
 27452-01 - 27452-06

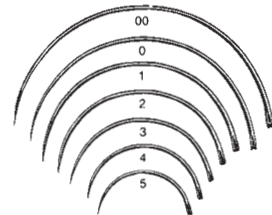

27465-20 - 27467-05 Pb

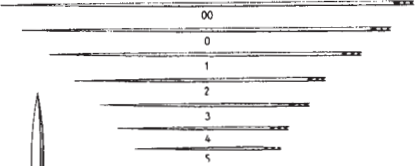

27475-20 - 27477-05 Pc

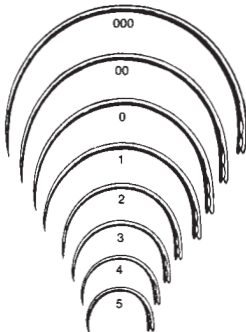

27443-30 - 27443-05

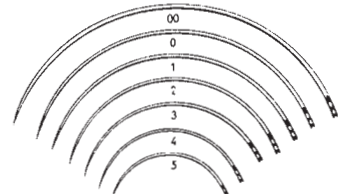

27485-20 - 27487-05 Pd



FIG.	000	00	0	1	2	3	4	5	6	7	8	9	10	11	12
KÖNIG				27441-01	27441-02	27441-03	27441-04	27441-05	27441-06	27441-07	27441-08	27441-09	27441-10	27441-11	27441-12
E	27443-30	27443-20	27443-10	27443-01	27443-02	27443-03	27443-04	27443-05							
KEITH				27450-01	27450-02	27450-03	27450-04	27450-05	27450-06						
KEITH					27452-01	27452-02	27452-03	27452-04	27452-05	27452-06					
Pb		27465-20	27465-10	27467-01	27467-02	27467-03	27467-04	27467-05							
Pc		27475-20	27475-10	27477-01	27477-02	27477-03	27477-04	27477-05							
Pd		27485-20	27485-10	27487-01	27487-02	27487-03	27487-04	27487-05							

Nahtinstrumente und Wundklammern
 Clips and Instruments
 Agrafes e instrumentos
 Agrafes e strumenti

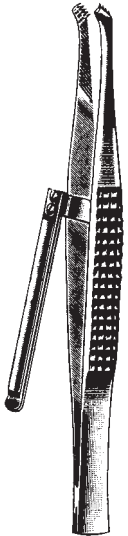

CHILDE
 27620-18
 18 cm, 7"



MICHEL
 27610-12
 12 cm, 4 3/4"



WACHENFELDT
 27612-12
 12,5 cm, 5"



WACHENFELDT
 27614-12
 12,5 cm, 5"



HEGENBARTH
 27616-12
 12,5 cm, 5"



MICHEL
 27630-12
 12 cm, 4 3/4"

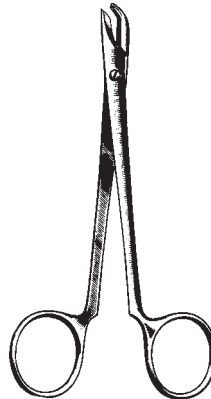

COLLIN
 27640-13
 13 cm, 5 1/8"

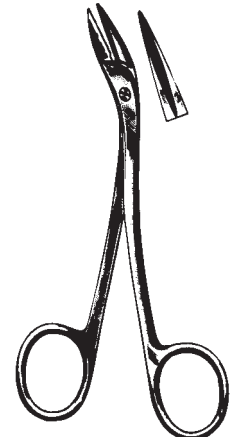

RICHTER-HEATH
 27642-14
 14 cm, 5 1/2"

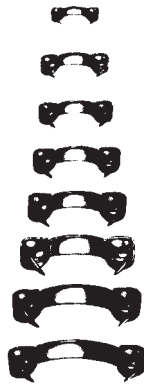

MICHEL

- MICHEL mm
 27660-07 7,5x1,75
 27660-11 11x2
 27660-12 12x3
 27660-14 14x3
 27660-16 16x3
 27660-18 18x3
 27660-20 20x3
 27660-22 22x3

Pack à 1000
 box of 1000
 paq x 1000
 confezione x 1000

Taschenbestecke
Pocket, Suturing Kits
Estuche de bolsillo y de sutura
Astucci tascabili e per sutura

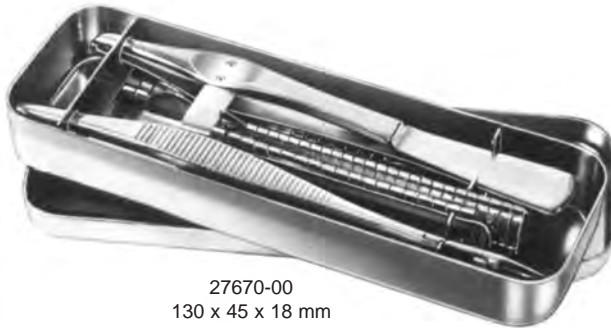

27670-00
130 x 45 x 18 mm

Wundnahtbesteck in Metall-Etui,
bestehend aus:
Michel Wundklammerzängchen
Wachenfeldt Faßpinzette
50 Michel Wundklammern

Estuche para sutura, en caja de metal,
compuesto de:
Pinza para agrafes de Michel
Pinza para juntar los bordes de la herida,
de Wachenfeldt, con porta-agrafas
50 Agrafes (Grapas) de Michel

Suture Clip set in metal case,
consisting of:
Suture Clip Forceps Michel
Approximation Forceps, Wachenfeldt,
with clip rack
50 suture clips Michel

Set di clip per suture in astuccio di metallo
composto da:
Pinza di Michel per clip
Pinza Wachenfeldt con fermagli per sutura
50 Agrafes di Michel

Taschenbestecke
Pocket, Suturing Kits
Estuche de bolsillo y de sutura
Astucci tascabili e per sutura



STANDARD

27680-00
165 x 90 x 28 mm

Komplett in Metalltui und Plastiktasche mit 2 herausnehmbaren gelochten Einlagen mit Stegen für Instrumente

Bestehend aus:

- 1 Mathieu Nadelhalter 14 cm (5 1/2")
- 1 Nähseide in Alkohol
- 6 Nähnadeln sortiert
- 1 Nadeldose gelocht 65 x 42 cm
- 1 Michel Wundklammerzange
- 20 Wundklammern auf Halter
- 1 Skalpellgriff mit Klinge
- 3 Klängen auswechselbar
- 1 Schere st/sp. 13 cm (5") gerade
- 1 anat. Pinzette 11,5 cm (4 1/2")
- 1 Hakenpinzette 1 x 2 Z. 12 cm (4 3/4")
- 1 Hunter Splitterpinzette 10,5 cm (4 1/4")
- 1 Kocher Arterienklemme 13 cm (5")
- 1 Myrtenblattsonde 13 cm (5")

Complete in metal case with plastic pouch and 2 removable perforated trays for instruments

Contents:

- 1 Mathieu Needle Holder, 14 cm (5 1/2")
- 1 Flacon with sterilized silk in alcohol
- 6 Suture Needles, assorted
- 1 Needle Case, 25.6" x 16.5", perforated
- 1 Michel Suture Clip Forceps
- 20 Michel Suture Clips with Clip Holder
- 1 Scalpel Handle with Blade
- 3 Scalpel Blades, interchangeable
- 1 Scissors, straight, blunt/sharp, 13 cm (5")
- 1 Dressing Forceps, 11,5 cm (4 1/2")
- 1 Tissue Forceps, 12 cm (4 3/4"), 1 x 2 teeth
- 1 Hunter Splitter Forceps, 10,5 cm (4 1/4")
- 1 Kocher Artery Forceps, straight, 13 cm (5"), S
- 1 Probe with myrtle leaf, 13 cm (5")

Completo en caja de metal con bolsa de plástico y 2 bandejas perforadas para los instrumentos

Contenido:

- 1 Porta-aguja de Mathieu, 14 cm (5 1/2")
- 1 Frasco con seda esterilizada para sutura, en alcohol
- 6 Agujas de sutura surtidas
- 1 Cajita para agujas, 65 x 42 mm, perforada
- 1 Pinza para agrafes de Michel
- 20 Agrafes de Michel, en su porta-agrafes
- 1 Mango de bisturi, con hoja intercambiable
- 3 Hojas intercambiables surtidas
- 1 Tijera, recta, roma/aguda, 13 cm (5")
- 1 Pinza de disección, 11,5 cm (4 1/2")
- 1 Pinza de disección, con 1 x 2 dientes, 12 cm (4 3/4")
- 1 Pinza para espinas de Hunter, 10,5 cm (4 1/4")
- 1 Pinza hemostática de Kocher, 13 cm (5"), S.
- 1 Estilete abotonado, multiforme, 13 cm (5")

Astuccio tascabile con due supporti estraibili

Contenente:

- 1 Port aghi di Mathieu 14 cm (5 1/2")
- 1 Set per sutura in flacone di vetro
- 6 aghi per sutura assortiti
- 1 scatola per aghi 65 x 24 perforata
- 1 pinza per sutura di Michel
- 20 Agrafe Michel ed porta agrafe
- 1 Manico da bisturi per lama intercambiabile
- 3 lame da bisturi intercambiabili
- 1 forbici rette alterne 13 cm (5")
- 1 pinze da dissezione
- 1 pinze da dissezione 1 x 2 denti
- 1 pinze di Hunter per schegge 10,5 cm (4 1/4")
- 1 pinze emostatiche di Kocher 13 cm (5")
- 1 specillo bottonuto 13 cm (5")

Sterilisierzangen, Abfallzange, Sterilisierklammern
 Sterilization Instruments, Waste Forceps, Safety pins
 Instrumentos para la esterilización, Pinza para desechos, Cadres de estérilización,
 Pinze per la sterilizzazione, Pinza per rifiuti, Spilloni p. sterilizzazione



DAVIS
 29102-16 16 cm, 6 1/4"
 29102-20 20 cm, 8"
 29102-24 24 cm, 9 1/2"

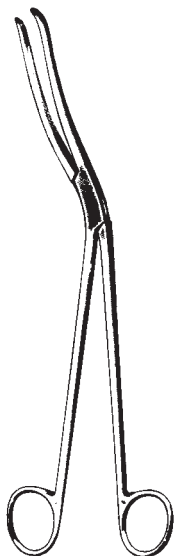

CHEATTLE
 29110-27
 27 cm, 10 1/2"

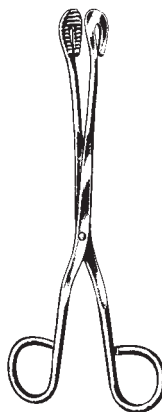

UNIVERSAL
 29120-20 20 cm, 8" 29121-20
 29120-28 28 cm, 11" 29121-28

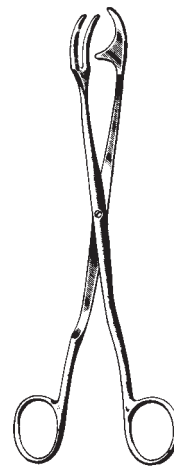

ROGGE
 29130-23
 23 cm, 9"



29140-20 20 cm, 8"
 29140-30 30 cm, 11 3/4"



SAUERBRUCH
 29145-55
 55 cm, 21.7"



BUNT
 29150-12 12 cm, 4 3/4"

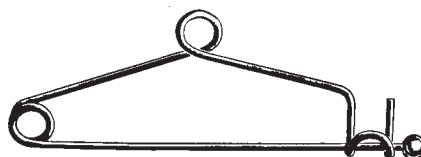

MAYO
 29152-14 14 cm, 5 1/2"

Gipsscheren
 Plaster of Paris Shears
 Cizallas para vendajes enyesados
 Cesioie per gessi

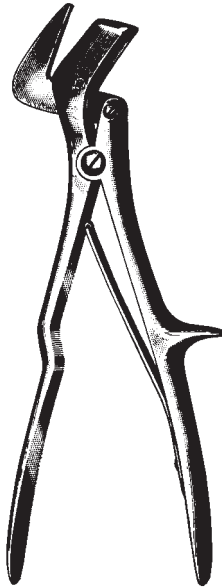

STILLE
 31101-24 24 cm, 9 1/2"



STILLE
 31103-23 23 cm, 9"
 31103-26 26 cm, 10 1/4"
 31103-37 37 cm, 14 1/2"



Gipsmesser
 plaster knife
 cuchillo para vendajes enyesados
 coltello da gesso

WIGMORE
 31120-19 19 cm, 7 1/2"

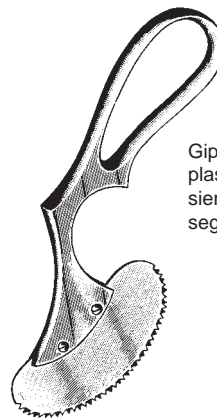

Gipssäge
 plaster saw
 sierra para vendajes enyesados
 sega da gesso

ENGEL
 31130-14
 verchromt

Oscillierende Gipssäge
 Oscillating Plaster Saw
 Sierra oscilante p. vendajes enyesados
 Segna oscillante per gessi

Elektrische Gipssäge
 Electric Plaster Cast Cutter
 Sierra eléctrica para yesos
 Segna elettrica per gessi



31210-21 110 Volt, compl. of Art.-Nr. 31212-02/31210-50/31210-65
 31210-22 230 Volt, compl. of Art.-Nr. 31212-02/31210-50/31210-65

Geräuschpegel min. 63 max. 69 DB
 Noise level machine only: Min. 63 Max. 69 db/(A)
 Nivel de ruido del aparato sólo 63 dB (min.), 69 dB/(A)
 Livello acustico dello strumento solo: min. 63 max. 69 db/(A)

EN 60601-1, EN 60601-1-2, IEC 60601-1, IEC 60601-1-2

31212-02
 Schlüsselpaar
 pair of screw driver
 par le Llave
 paio di chiavi

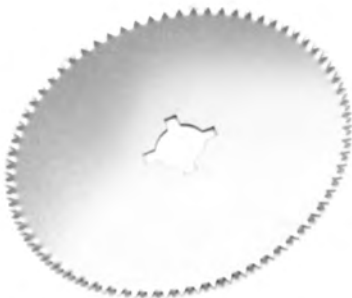

31210-50	50 mm (2.0") Ø	weich *
31210-65	65 mm (2.6") Ø	weich *
31211-50	50 mm (2.0") Ø	hart *
31211-65	65 mm (2.6") Ø	hart *

- * Ersatz-Sägeblätter, spezialgehärtet (F. Fiberglas u. andere Hartverbände)
- * Spare saw blades, special hardness (for dressing of fiber glass for other hard dressing)
- * Hojas de repuesto, templadas especialmente (para vendajes de fibra de vidrio y otros vendajes duros)
- * Lame per sega a tempera speciale per bendaggi (in fibro di vetro ed altri bendaggi duri)

Oscillierende Gipssäge mit Staubabsauger
Oscillating Plaster Saw with plaster vacuum
Sierra oscillante con aspiraciòn
Sega oscillante per gesso con aspirazione



31250-00

Autopsiesäge
Autopsy saw
Sierra para autopsia
Sega per autopsia

Schnellspannfutter
Quick-action chuck
tuerca de fijación rapida
Mandrino rapido

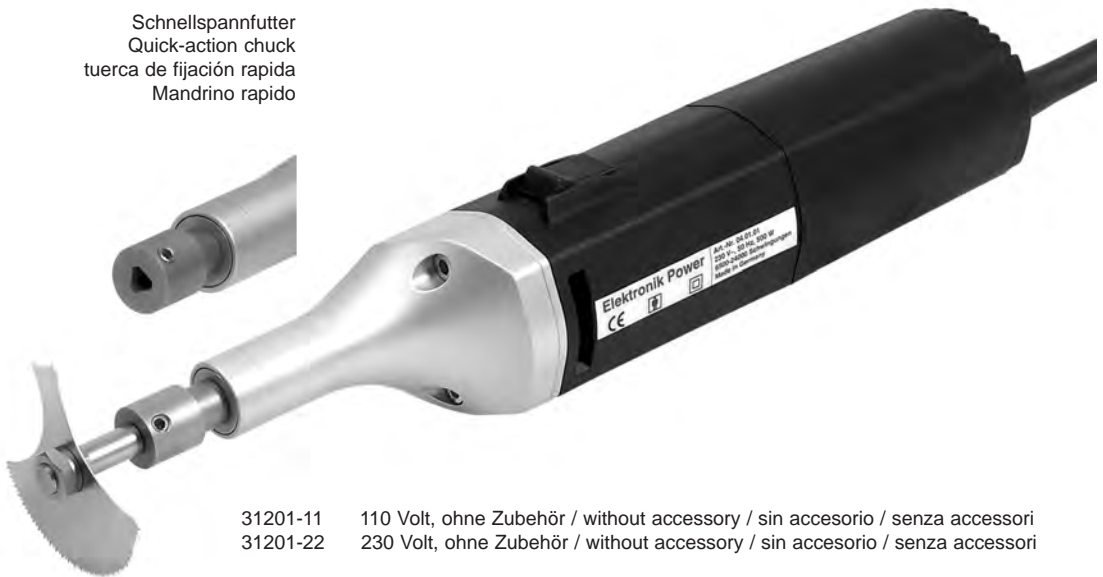

31201-11 110 Volt, ohne Zubehör / without accessory / sin accesorio / senza accessori
31201-22 230 Volt, ohne Zubehör / without accessory / sin accesorio / senza accessori

Geräuschpegel min. 63 max. 69 DB
Noise level machine only: Min. 63 Max. 69 db/(A)
Nivel de ruido del aparato sólo 63 dB (mín.), 69 dB/(A)
Livello acustico dello strumento solo: min. 63 max. 69 db/(A)

EN 60601-1, EN 60601-1-2, IEC 60601-1, IEC 60601-1-2

Zubehör zur Autopsiesäge
 Accessories for Autopsy saw
 Accesorio para la sierra de autopsia
 Accessori per sega per autopsia

Segmentssäge

besteht aus:
 1 x 31204-01 Segment-Sägeblatt
 1 x 31201-39 Schaft 39 mm

Segment saw

consisting of:
 1 x 31204-01 segment saw
 1 x 31201-39 arbor 39 mm

Sierra para segmento

compuesto de:
 1 x 31204-01 hoja de sierra
 1 x 31201-39 vastago 39 mm

Sega a segmento

composta da:
 1 x 31204-01 Lama a segmento
 1 x 31201-39 Asta 39 mm

Tiefensäge

besteht aus:
 1 x 31205-20 Tiefen-Sägeblatt, 20 mm
 1 x 31201-39 Schaft 39 mm

Deep cutting saw

consisting of:
 1 x 31205-20 deep cutting saw, 20 mm
 1 x 31201-39 arbor 39 mm

Sierra de profundidad

compuesto de:
 1 x 31205-20 hoja de sierra, 20 mm
 1 x 31201-39 vastago 39 mm

Sega a taglio di profondità

composta da:
 1 x 31205-20 Lama a taglio di profondità, 20 mm
 1 x 31201-39 Asta 39 mm

Tiefensäge schmal

besteht aus:
 1 x 31205-08 Tiefen-Sägeblatt, 8 mm
 1 x 31201-39 Schaft 39 mm

Deep cutting saw narrow

consisting of:
 1 x 31205-08 deep cutting saw, 8 mm
 1 x 31201-39 arbor 39 mm

Sierra de profundiad, estrecha

compuesto de:
 1 x 31205-08 hoja de sierra, 8 mm
 1 x 31201-39 vastago 39 mm

Sega a taglio sottile di profondità

composta da:
 1 x 31205-08 Lama a taglio di profondità, 8 mm
 1 x 31201-39 Asta 39 mm

Kreissäge ø 65 mm

mit exzentrischer Begrenzungsscheibe für differenzierte Schnitt-Tiefe von 4 bis 11 mm,
 besteht aus:
 1 x 31210-65 Sägeblatt ø 65 mm
 1 x 31203-50 Begrenzungsscheibe
 1 x 31201-39 Schaft 39 mm

Circular saw ø 65 mm

with eccentric disk to limit depth of cut from 4 - 11 mm
 consisting of:
 1 x 31210-65 circular saw ø 65 mm
 1 x 31203-50 limiting disc
 1 x 31201-39 arbor 39 mm

Sierra circular ø 65 mm

con disco de tope excentrico para diferentes cortes de profundidad de 4 mm hasta 11 mm
 compuesto de:
 1 x 31210-65 hoja de sierra, ø 65 mm
 1 x 31203-50 disco de tope
 1 x 31201-39 vastago 39 mm

Sega circolare diam. 65 mm

con disco di limitazione eccentrico per taglio differenziato dal 4 mm al 11 mm,
 composta da:
 1 x 31210-65 Lama circolare, ø 65 mm
 1 x 31203-50 Disco eccentrico
 1 x 31201-39 Asta 39 mm

Zubehör zur Autopsiesäge
 Accessories for Autopsy saw
 Accesorio para la sierra de autopsia
 Accessori per sega per autopsia



31201-39
 Schaft, 39 mm lang
 arbor, 39 mm
 vastago, 39 mm de largo
 asta, lunghezza 39 mm



31201-58
 Schaft, 58 mm lang
 arbor, 58 mm
 vastago, 58 mm de largo
 asta, lunghezza 58 mm



31202-16
 Imbusschlüssel mit T-Griff zum Befestigen des Bohrfutters
 Alan key wit T-handle
 Llave hexagonal con mango de T para fijacion del taladro
 Chiave esagonale con manico a T per fissaggio del mandrino



31212-02
 Schlüsselpaar zum Auswechseln der Sägeblätter
 pair of screw driver
 par de llave para cambiar las hojas de sierra
 Paio di chiavi per cambio delle lame

Gipsspreizer, Gipsabreißzangen
 Plaster Cast Instruments
 Instrumentos para vendajes enyesados
 Allargagessi, Strappagessi

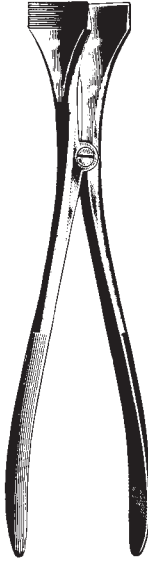

HENNIG
 31350-28 28 cm, 11"



BEESON
 31360-30 30 cm, 11 3/4"

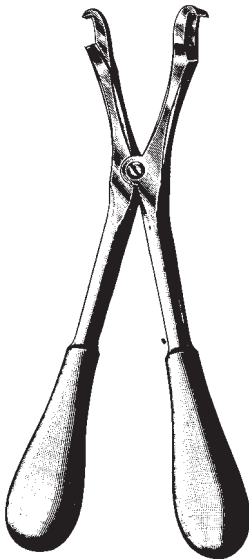

HAGLUND-STILLE
 31362-28 28 cm, 11"



REDA
 31366-23 23 cm, 9"

Gipsspreizer, Gipsmesser, Gipsabreißzangen
Plaster Cast Instruments, Knives
Instrumentos para vendajes enyesados, Cuchillos
Allargagessi, Coltelli per Gessi, Strappagessi



HOPKINS
31370-20
20 cm, 8"



ESMARCH
31380-18
18 cm, 7"



REINER
31390-18
18 cm, 7"



WOLFF
31395-18
18 cm, 7"



WOLFF
31397-24
24 cm, 9 1/2"

Hohlmeißelzangen
 Bone Rongeurs
 Pinzas-gubias
 Pinze sgorbie

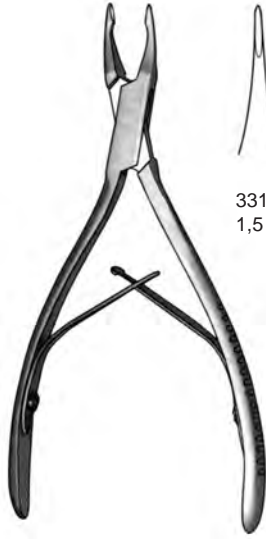

33100-01
 1,5 x 5 mm



33100-02
 1,5 x 5 mm

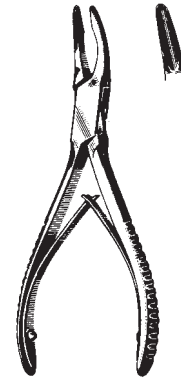

FRIEDMAN Mini
 33101-12 12 cm, 4 3/4"

MICRO FRIEDMAN
 33100-02 14 cm, 5 1/2"

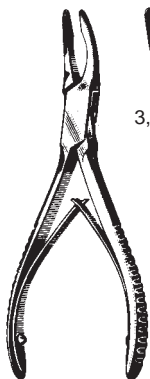

3,5 mm

FRIEDMAN
 33101-14 14 cm, 5 1/2"

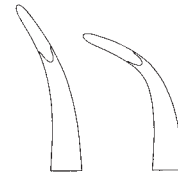

33102-01
 2 mm

33102-02
 2 mm

STELLBRINK
 33102-02 17 cm, 6 3/4"

Hohlmeißelzangen
Bone Rongeurs
Pinzas-gubias
Pinze sgorbie

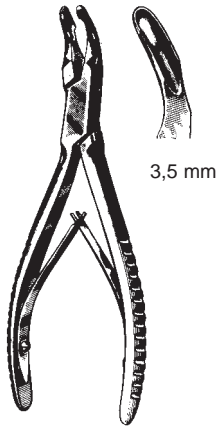

CLEVELAND
33103-14 14 cm, 5 1/2"

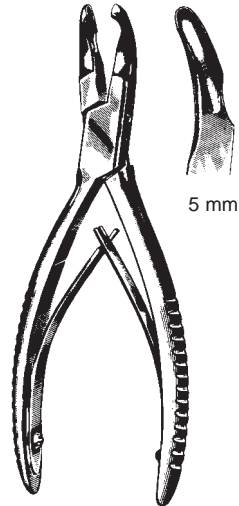

CLEVELAND
33105-17 17 cm, 6 3/4"

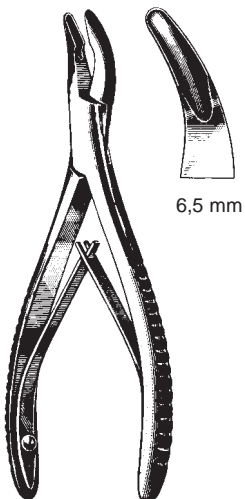

MEAD
33107-16 16,5 cm, 6 1/2"

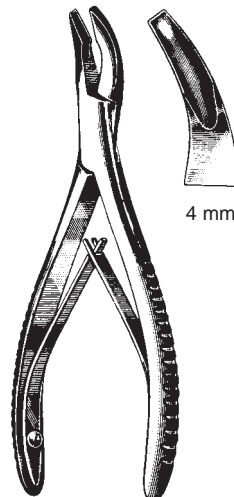

MEAD
33109-16 16,5 cm, 6 1/2"

Hohlmeißelzangen
 Bone Rongeurs
 Pinzas-gubias
 Pinze sgorbie

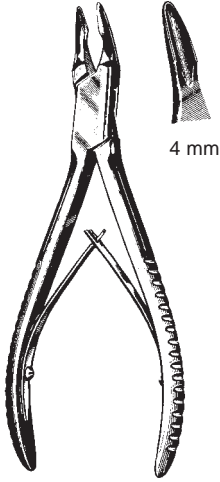

BLUMENTHAL
 33115-15
 15,5 cm, 6"

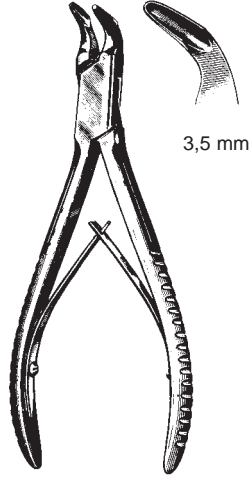

BLUMENTHAL
 33117-15
 15,5 cm, 6"

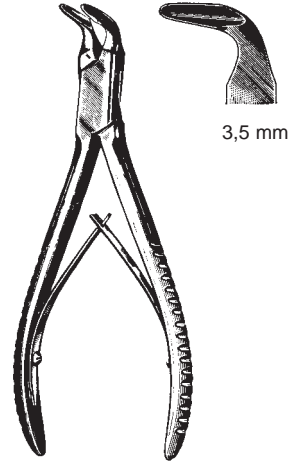

BLUMENTHAL
 33119-15
 15,5 cm, 6"

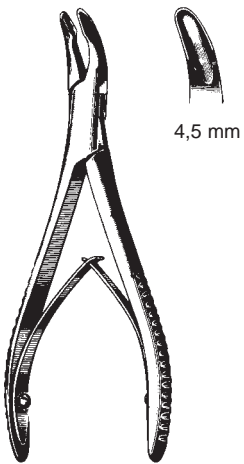

LUER
 33131-15
 15 cm, 5.9"

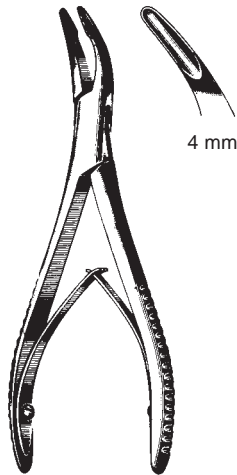

LUER
 33133-15
 15 cm, 5.9"

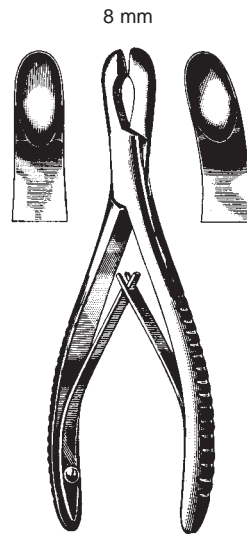

LUER
 33136-17 33137-17
 17 cm, 6 3/4"

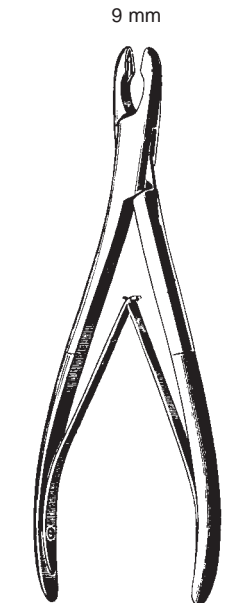

ADSON
 33142-20 33143-20
 20 cm, 7.9"

Hohlmeißelzangen
 Bone Rongeurs
 Pinzas-gubias
 Pinze sgorbie

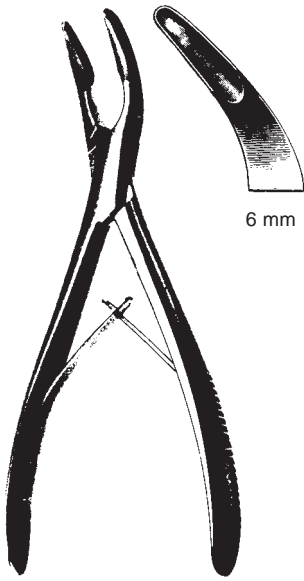

OLIVECRONA
 33147-20
 20 cm, 7.9"



BANE-HARTMANN
 33148-18
 17,5 cm, 7"

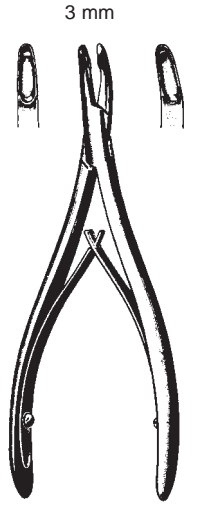

LEMPERT
 33150-16 33151-16
 16 cm, 6 1/4"



JANSEN
 17 cm, 6 3/4"



LEMPERT
 33154-18 33155-18
 18,5 cm, 7 1/4"



BEYER
 33156-18
 18 cm, 7"

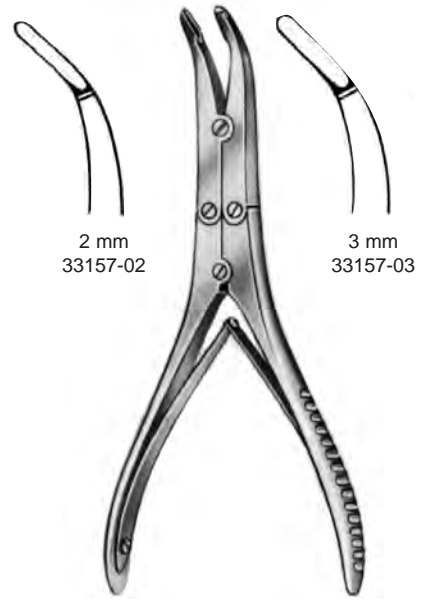

KLEINERT-KUTZ
 15 cm, 6"

Hohlmeißelzangen
 Bone Rongeurs
 Pinzas-gubias
 Pinze sgorbie



3 mm
33157-04



4 mm
33157-05



5 mm
33157-06



3 mm
33158-03



4 mm
33158-04



5 mm
33158-05



3 mm
33159-03



4 mm
33159-04



5 mm
33159-05



SMITH-PETERSEN
24 cm, 9 1/2"

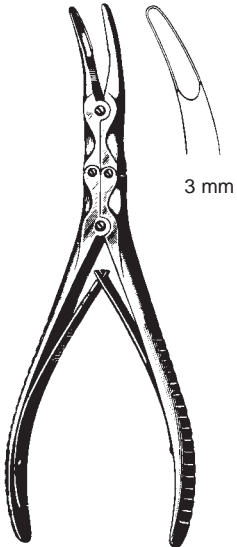

BEYER
33201-18
18 cm, 7"



MAYFIELD
33202-18
18 cm, 7"

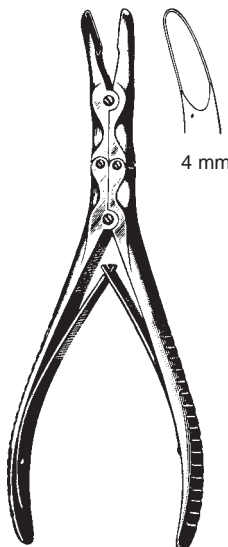

ZAUFAL-JANSEN
33205-18
18 cm, 7"

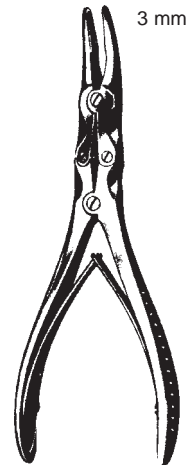

— BÖHLER —
33211-15 33213-15
15 cm, 6"

Hohlmeißelzangen
 Bone Rongeurs
 Pinzas-gubias
 Pinze sgorbie

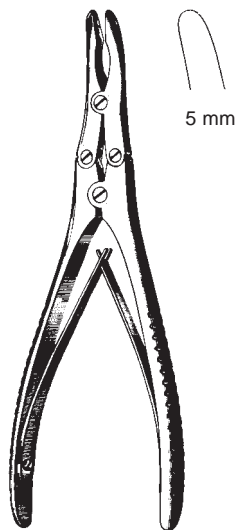

— RUSKIN —
 33216-18 33217-18
 18 cm, 7"

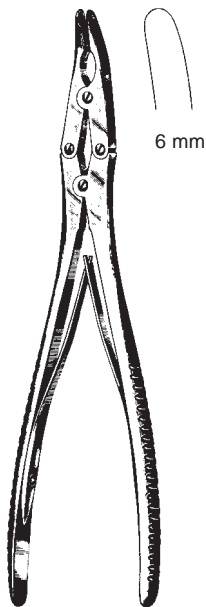

RUSKIN
 33219-23 23 cm, 9"



MARQUARDT
 33220-20 20 cm, 8"

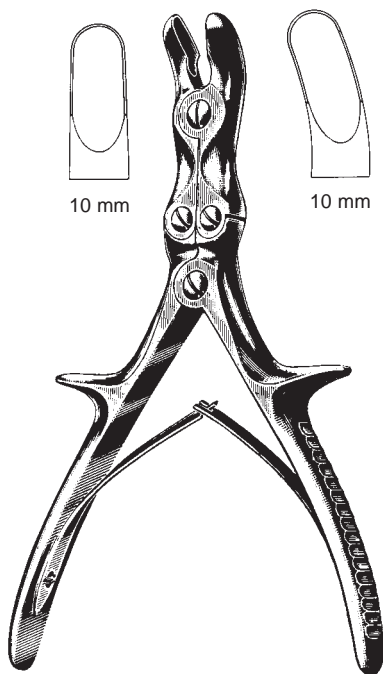

— STILLE-LUER —
 33230-22 22 cm, 8 3/4" 33231-22
 33230-26 26 cm, 10 1/4" 33231-26

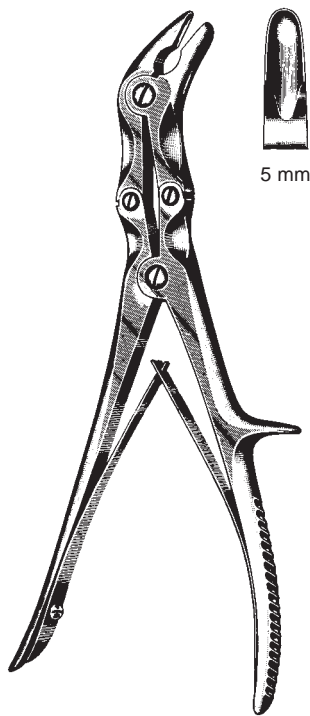

STILLE-LUER
 33235-23
 23 cm, 9"

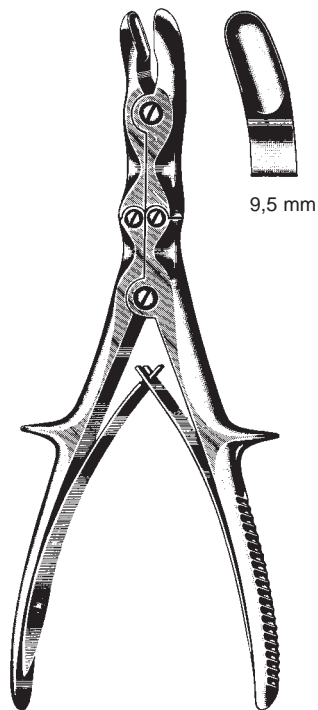

STILLE-RUSKIN
 33237-23
 23 cm, 9"

Hohlmeißelzangen
 Bone Rongeurs
 Pinzas-gubias
 Pinze sgorbie

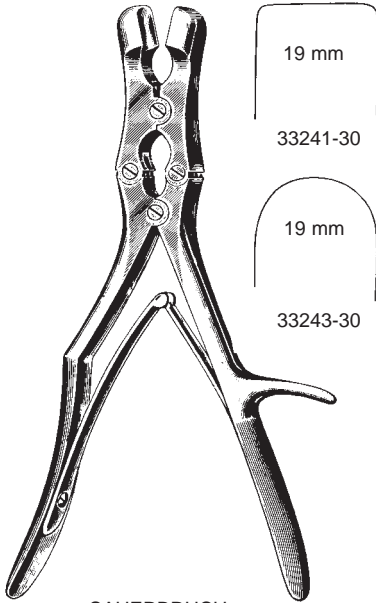

SAUERBRUCH
 30 cm, 10 3/4"

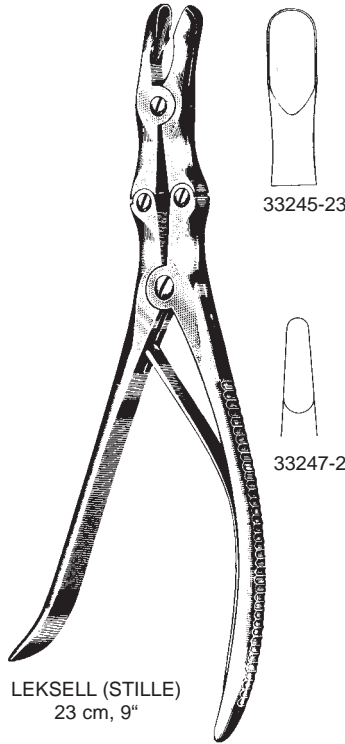

LEKSELL (STILLE)
 23 cm, 9"

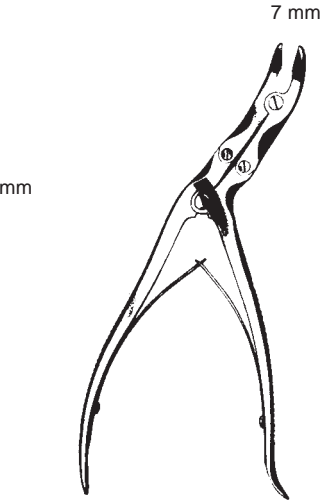

SCAGLIETTI
 R 33251-26 rechts right derecha a destra
 L 33253-26 links left izquierda a sinistra
 26 cm, 10 1/4"



ECHLIN
 33257-23 2 mm
 33258-23 4 mm
 33259-23 3 mm
 23 cm, 9"



FRYKHOLM
 33260-24
 24 cm, 9 1/2"

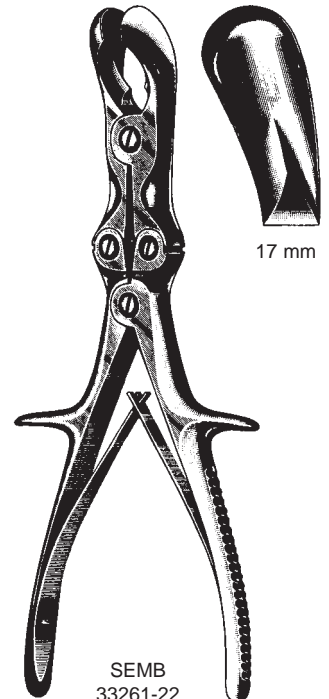

SEMB
 33261-22
 22,5 cm, 8.9"

Knochensplitterzangen
 Bone Cutting Forceps
 Pinzas cortantes para huesos
 Cesioie per ossa

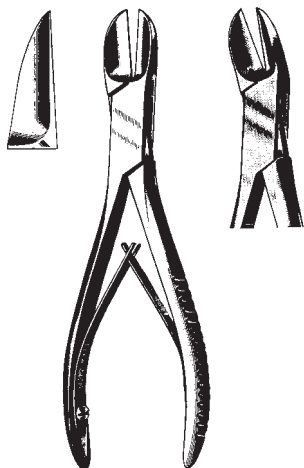

LISTON

33274-14 14 cm, 5 1/2" 33275-14
 33274-17 17 cm, 6 3/4" 33275-17
 33274-19 19 cm, 7 1/2" 33275-19
 33274-22 22 cm, 8 3/4" 33275-22



BÖHLER

33280-15 33281-15
 15 cm, 6"



COTTLE-KAZANJIAN

33282-19
 19 cm, 7 1/2"



MC INDOE
 33283-17
 17 cm, 6 3/4"



STAMM
 33284-15
 15 cm, 6"

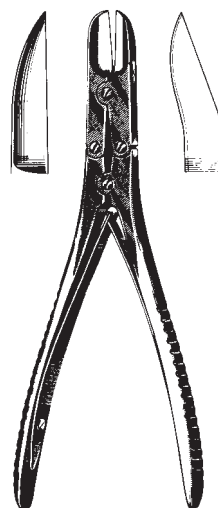

RUSKIN-LISTON

33286-18 33289-18
 18 cm, 7"

Knochensplitterzangen
 Bone Cutting Forceps
 Pinzas cortantes para huesos
 Cesoi e per ossa

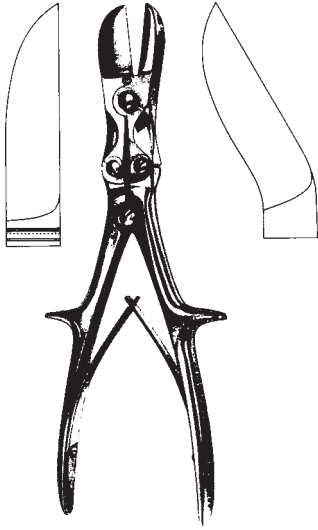

— STILLE-LISTON —
 33290-23 23 cm, 9" 33291-23
 33290-27 27 cm, 10 1/2" 33291-27



STILLE-LISTON
 33292-26
 26 cm, 10 1/4"

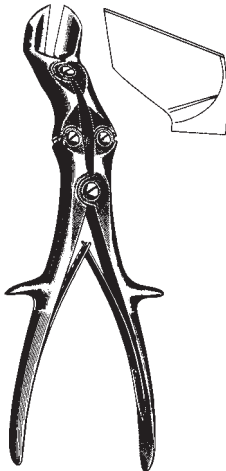

STILLE-HORSLEY
 33293-27
 27 cm, 10 1/2"

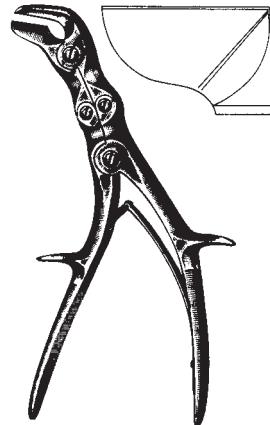

SEMB
 33295-24
 24 cm, 9 1/2"

Knochenhalte­zangen
 Bone Holding Forceps
 Pinzas para huesos
 Tenaglie per ossa

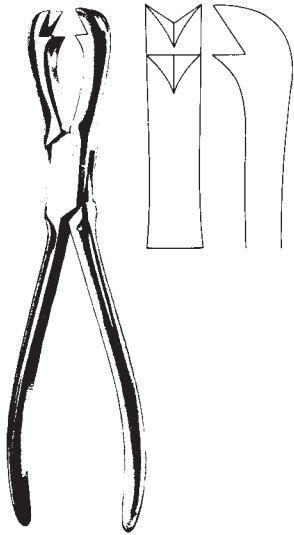

FERGUSON
 33360-21
 21 cm, 8 1/4"

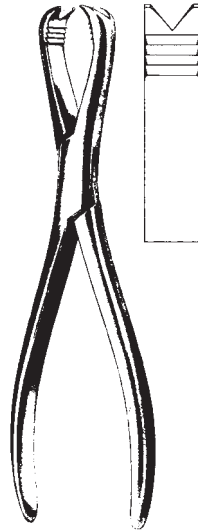

LANGENBECK
 33362-21
 21 cm, 8 1/4"

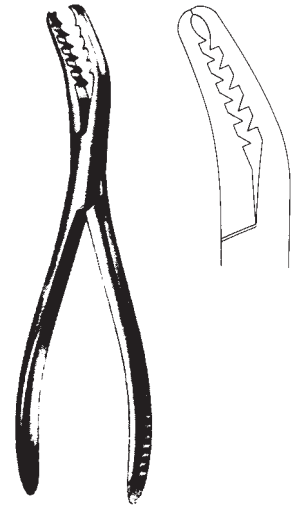

SEMB
 33365-19 19 cm, 7 1/2"



SEMB
 33366-19 20 cm, 8"
 mit Sperre



FARABEUF
 33366-23 23 cm, 9"
 33366-26 26 cm, 10 1/4"



FARABEUF-LAMBOTTE
 33368-26
 26 cm, 10 1/4"

Knochenhalte­zangen
Bone Holding Forceps
Pinzas para huesos
Tenaglie per ossa

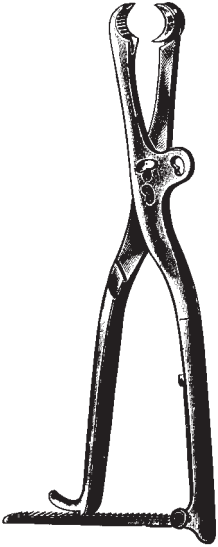

LAMBOTTE

33370-22 22 cm, 8 3/4"
33370-27 27 cm, 10 1/2"
33370-30 30 cm, 11 3/4"

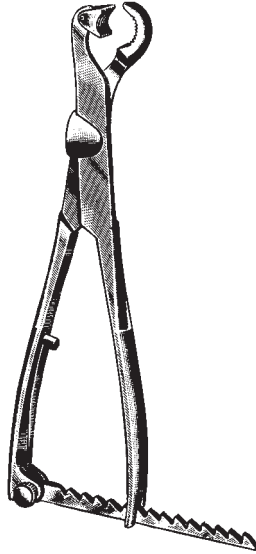

LAMBOTTE

33372-22 22 cm, 8 3/4"
33372-26 26 cm, 10 1/4"
33372-33 33 cm, 13"

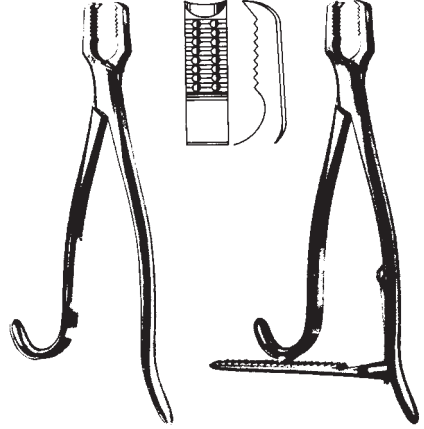

KERN

33378-15 15 cm, 6" 33380-15
33378-17 17 cm, 6 3/4" 33380-17
33378-21 21 cm, 8 1/4" 33380-21

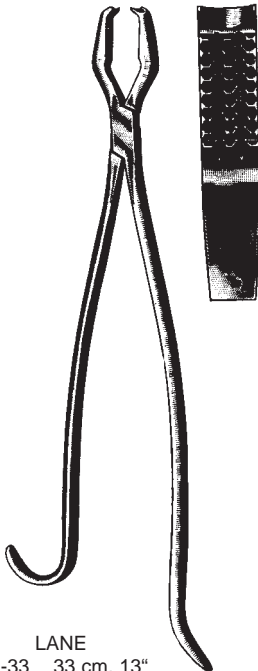

LANE

33382-33 33 cm, 13"
33382-45 45 cm, 17 3/4"

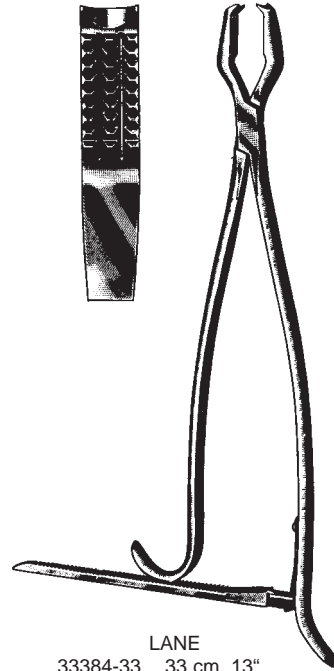

LANE

33384-33 33 cm, 13"
33384-45 45 cm, 17 3/4"

Knochenhaltezangen
 Bone Holding Forceps
 Pinzas para huesos
 Tenaglie per ossa

selbstzentrierend
 self-centering
 autocentrantes
 autocentranti

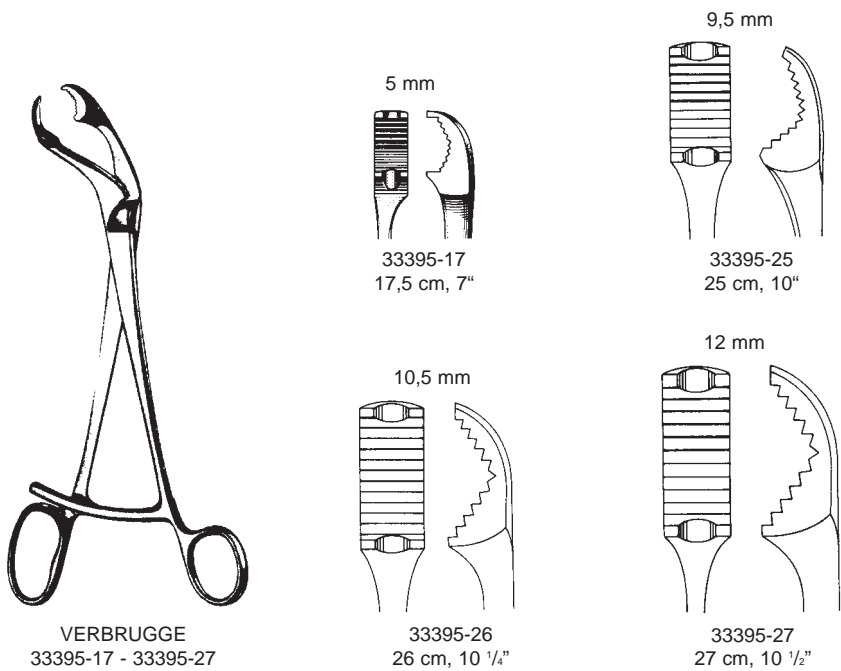
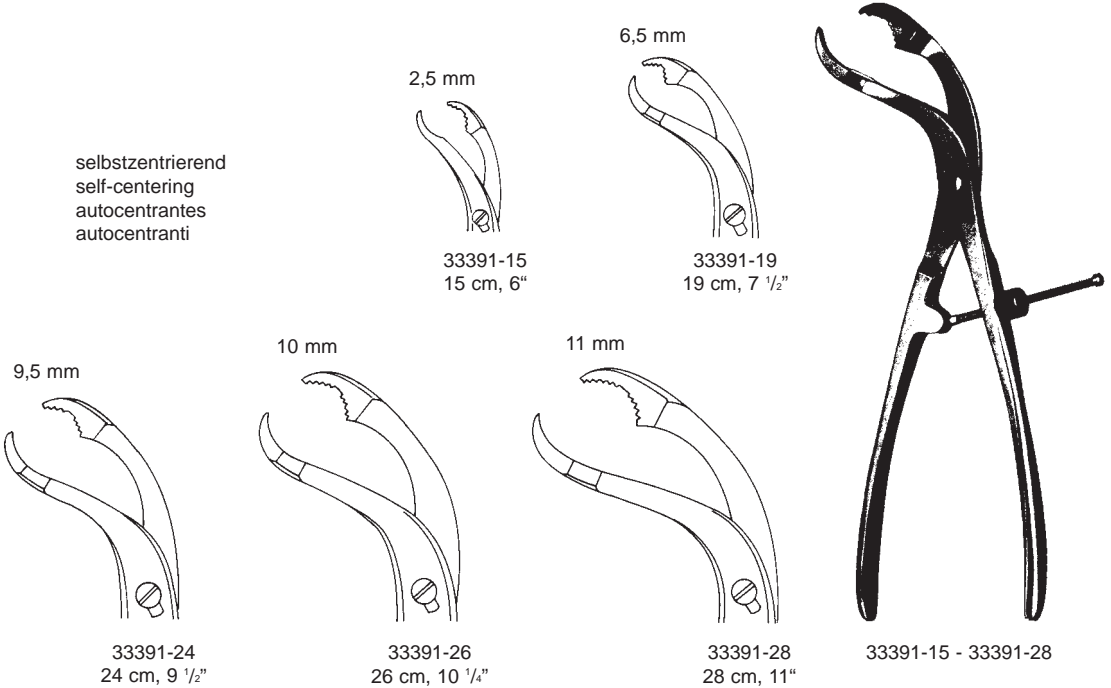

Knochenhalte­zangen
Bone Holding Forceps
Pinzas para huesos
Tenaglie per ossa

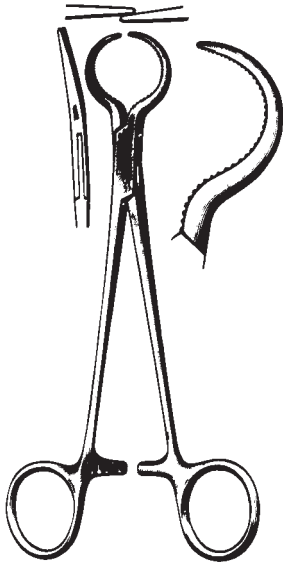

LEWIN
33402-17
17,5 cm, 7"



BIRCHER-GANSKE
33404-20 33405-20
20 cm, 8"



33406-20
20 cm, 8"



DINGMANN
33407-19
19 cm, 7 1/2"



REDA
33409-13
13,5 cm, 5 1/4"



MARTIN
33410-19
19 cm, 7 1/2"

Knochenhaltezangen
 Bone Holding Forceps
 Pinzas para huesos
 Tenaglie per ossa



REDA
 33412-16 - 33412-24

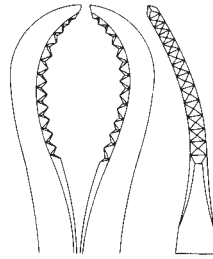

33412-16
 16 cm, 6 1/4"

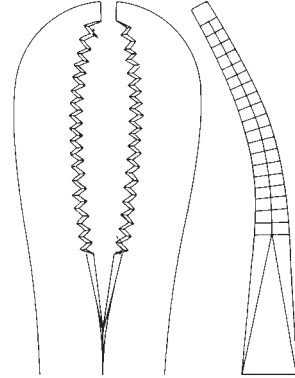

33412-24
 24 cm, 9 1/2"

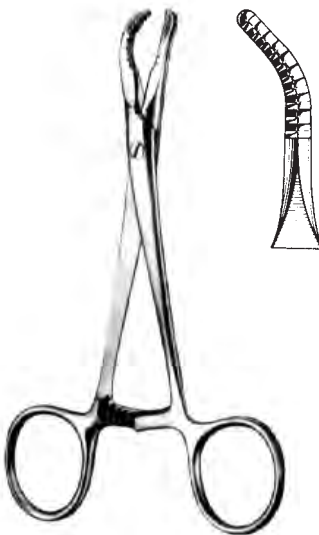

REDA
 33413-14
 13,5 cm, 5 1/4"



33414-21
 21 cm, 8 1/4"

Knochenhalte­zangen
Bone Holding Forceps
Pinzas para huesos
Tenaglie per ossa



ULRICH
33415-23 - 33415-28

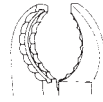

33415-23
23 cm, 9"

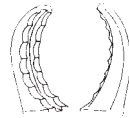

33415-25
25 cm, 10"

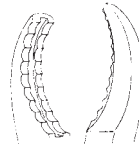

33415-28
28 cm, 11"

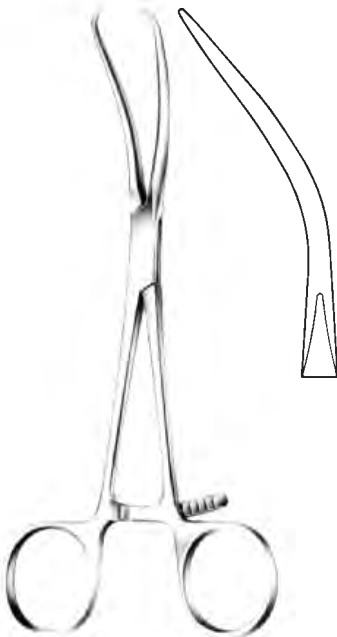

REILL
33416-17
17 cm, 6 3/4"



PATELLA
33417-18
18,5 cm, 7 1/4"

Knochenhalte­zangen, -Klammern
 Bone holding forceps, -Clamps
 Pinzas para huesos, Clamps porta-huesos
 Tenaglie per ossa, Pinze per ossa

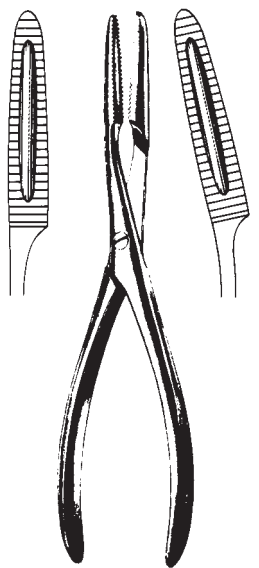

33420-20 33421-20
 20 cm, 8"

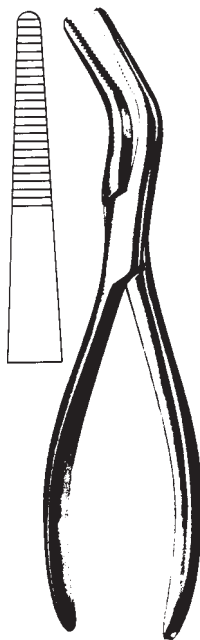

VAN BUREN
 33423-23
 23 cm, 9"



FELDHEIM
 33424-10
 10 cm, 4"



LOWMAN
 33441-13 13 cm, 5 1/8"
 33441-18 18 cm, 7"
 33441-20 20 cm, 8"



LOWMAN-HOGLUND
 33442-19
 19 cm, 7 1/2"

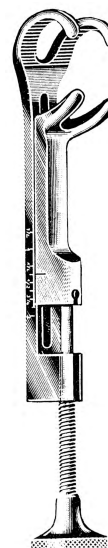

LAMBERT-LOWMAN
 33443-18
 18 cm, 7"

Knochenhaltezangen, Bleihand
 Bone holding forceps, Lead Hands
 Pinzas para huesos, Manoplas de plomo
 Tenaglie per ossa, Mani di piombo

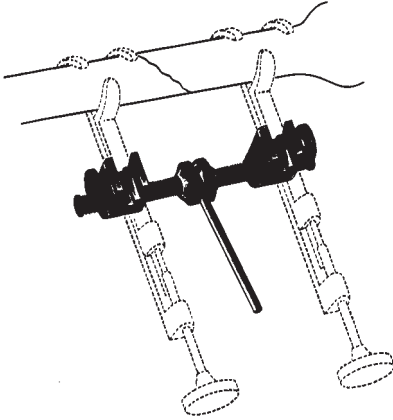

GERSTER
33444-15



33450-01
 32 cm, 12 ³/₄"
 Erwachsen
 adult size
 p. adultos
 p. adulti

33450-02
 24 cm, 9 ¹/₂"
 Kind
 child size
 p. niños
 p. bambini

Scharfe Löffel
Bone Currettes
Cucharillas cortantes
Curette taglienti

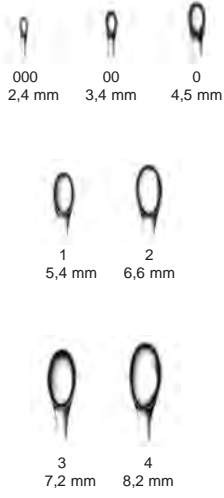

SCHEIDE	Fig.	VOLKMANN
	0000	33469-96
33467-97	000	33469-97
33467-98	00	33469-98
33468-00	0	33470-00
33468-01	1	33470-01
33468-02	2	33470-02
33468-03	3	33470-03
33468-04	4	33470-04
	5	33470-05
	6	33470-06

SCHEIDE
17 cm, 6 3/4"
33467-97 - 33468-04

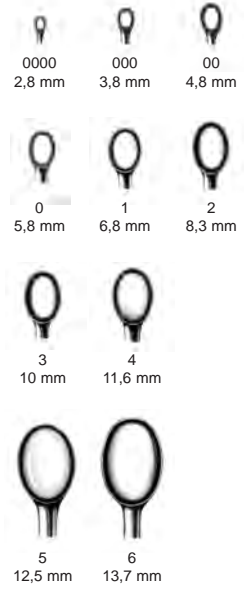

VOLKMANN
17 cm, 6 3/4"
33469-96 - 33470-06

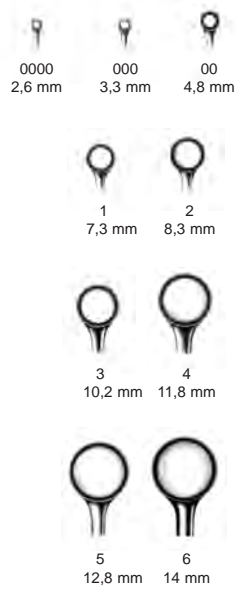

BRUNS	Fig.	SPRATT
33471-96	0000	33474-96
33471-97	000	33474-97
33471-98	00	33474-98
33472-00	0	33475-00
33472-01	1	33475-01
33472-02	2	33475-02
33472-03	3	33475-03
33472-04	4	33475-04
33472-05	5	33475-05
33472-06	6	33475-06

BRUNS
17 cm, 6 3/4"
33471-96 - 33472-06

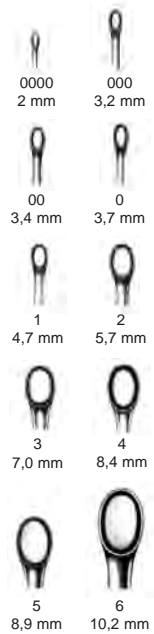

SPRATT
17 cm, 6 3/4"
33474-97 - 33475-06

Scharfe Löffel
 Bone Currettes
 Cucharillas cortantes
 Curette taglienti



COBB
 27,9 cm 11"

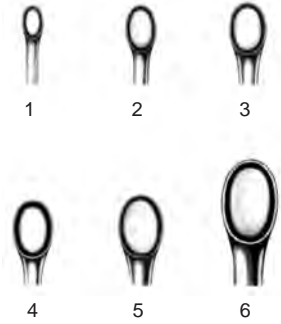
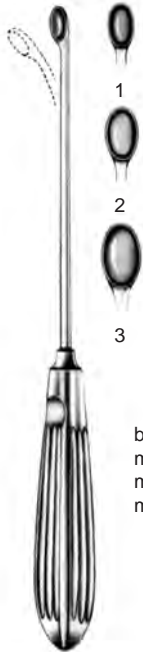

Fig.		
1	33473-01	3,5 mm
2	33473-02	4,5 mm
3	33473-03	5,5 mm
4	33473-04	7,5 mm
5	33473-05	8,5 mm
6	33473-06	10,0 mm

Scharfe Löffel
Bone Currettes
Cucharillas cortantes
Curette taglienti



- Fig.
1 33476-01 4,8 mm
2 33476-02 5,8 mm
3 33476-03 6,8 mm

biegsam
malleable
maleable
malleabile

HALLE

21 cm, 8 1/4"

33476-01 - 33476-02



- Fig.
000 33476-98 2,8 mm
00 33476-99 3,3 mm
0 33477-00 3,7 mm
1 33477-01 4,3 mm
2 33477-02 4,8 mm
3 33477-03 5,6 mm
4 33477-04 6,1 mm
5 33477-05 6,7 mm
6 33477-06 8,8 mm

SPINAL

20 cm, 8"

33476-98 - 33477-06

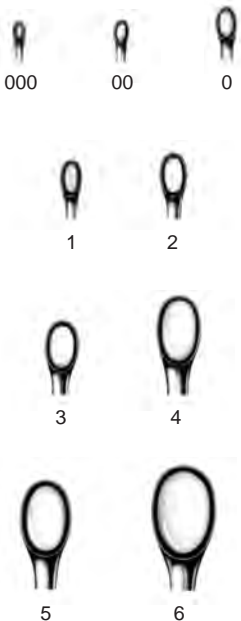

- Fig.
000 33478-98 2,8 mm
00 33478-99 3,3 mm
0 33479-00 3,7 mm
1 33479-01 4,3 mm
2 33479-02 4,8 mm
3 33479-03 5,6 mm
4 33479-04 6,1 mm
5 33479-05 6,7 mm
6 33479-06 8,8 mm



SPINAL
20 cm, 8"

33478-98 - 33479-06



33482-01 4,7 mm



33482-02 4,7 mm



33482-03 4,7 mm

SCOVILLE
25 cm, 10"

33482-01 - 33482-03

Scharfe Löffel
Bone Currettes
Cucharillas cortantes
Curette taglianti

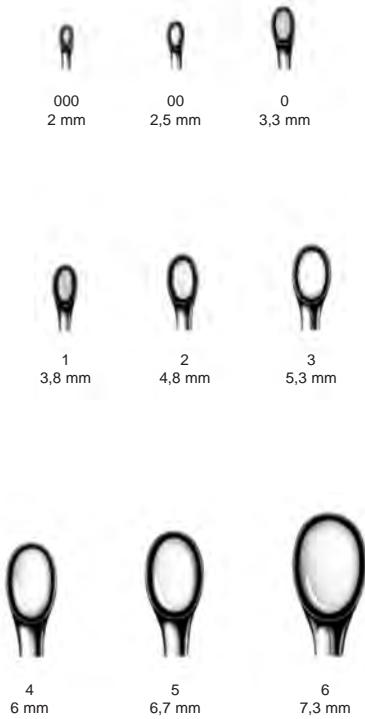

BRUNS
23 cm, 9"



BRUNS
23 cm, 9"



BRUNS
23 cm, 9"

Fig.
000
00
0
1
2
3
4
5
6

33480-97
33480-98
33481-00
33481-01
33481-02
33481-03
33481-04
33481-05
33481-06

33482-97 2,8 mm
33482-98 3,3 mm
33483-00 3,7 mm
33483-01 4,3 mm
33483-02 4,8 mm
33483-03 5,6 mm
33483-04 6,1 mm
33483-05 6,7 mm
33483-06 8,8 mm

33484-97 2,8 mm
33484-98 3,3 mm
33485-00 3,7 mm
33485-01 4,3 mm
33485-02 4,8 mm
33485-03 5,6 mm
33485-04 6,1 mm
33485-05 6,7 mm
33485-06 8,8 mm

Scharfe Löffel
Bone Currettes
Cucharillas cortantes
Curette taglienti



33485-21 21 cm, 8 1/4"
oval/rund
ovale/ronde
ovalado/redondo
ovale/rotonda



WILLIGER
17,5 cm
7"

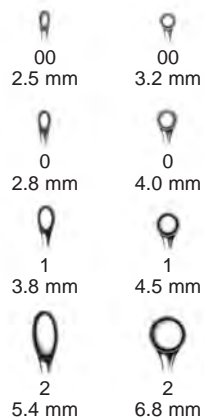
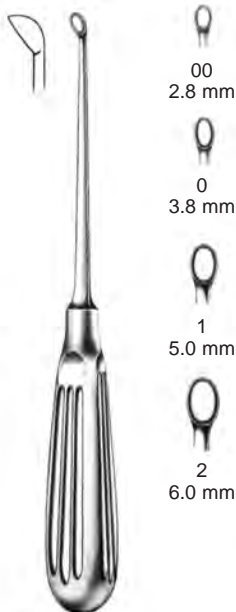

Fig. 00	33485-99	33486-99
0	33486-00	33487-00
1	33486-01	33487-01
2	33486-02	33487-02



DAUBENSPECK	Fig. 00	33487-99
20 cm, 8"	0	33488-00
	1	33488-01
	2	33488-02



27 cm	Fig. 0	33489-00
10 1/2"	1	33489-01
	2	33489-02
	3	33489-03

Scharfe Löffel
 Bone Currettes
 Cucharillas cortantes
 Curette taglianti



LEMPERT
 17,5 cm, 7"



0



00



000



0000



00000

Fig. 0	33490-10	3,3 mm
00	33490-20	3,0 mm
000	33490-30	2,7 mm
0000	33490-40	2,4 mm
00000	33490-50	2,0 mm



REDA
 25 cm, 10"



000
 3,6 mm

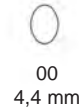

00
 4,4 mm

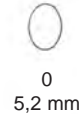

0
 5,2 mm

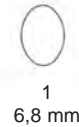

1
 6,8 mm

Fig. 000	33491-01
00	33491-02
0	33491-03
1	33491-04



REDA
 25 cm, 10"



000
 3,6 mm

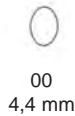

00
 4,4 mm

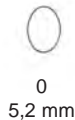

0
 5,2 mm

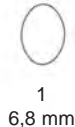

1
 6,8 mm

Fig. 000	33500-01
00	33500-02
0	33500-03



BUSHE
 25 cm, 10"

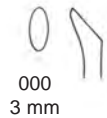

000
 3 mm



00
 4 mm

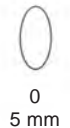

0
 5 mm

Fig. 000	33491-05
00	33491-06
0	33491-07
1	33491-08

Scharfe Löffel
Bone Curettes
Cucharillas cortantes
Curette taglienti



33492-13 6.3 mm
33492-16 7.0 mm
33492-20 9.1 mm

33492-13 6.8 mm
33492-16 9.0 mm
33492-20 11.1 mm

VOLKMANN

33492-13 13 cm, 5 1/8"
33492-16 16 cm, 6 1/4"
33492-20 20 cm, 8"



33494-13 7.5 mm
33494-14 6.8 mm
33494-17 6.8 mm

33494-13 6.3 mm
33494-14 6.2 mm
33494-17 7.3 mm

VOLKMANN

33494-13 13 cm, 5 1/8"
33494-14 14 cm, 5 1/2"
33494-17 17 cm, 6 3/4"

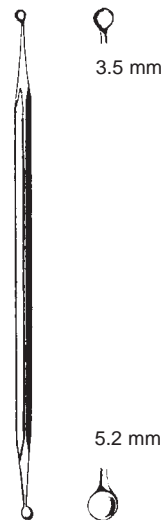

3.5 mm

5.2 mm

JANSEN

33495-16
16 cm, 6 1/4"

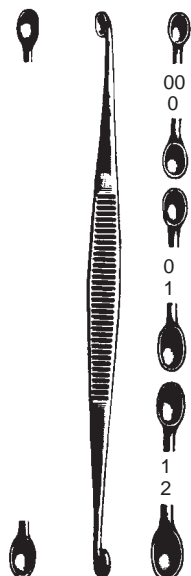

00 2.5 mm
0 3.0 mm

0 3.0 mm
1 3.5 mm

1 3.5 mm
2 4.0 mm

WILLIGER

13,5 cm, 5 1/4" Fig.
33496-00 00/0
33496-01 0/1
33496-12 1/2



4.0 mm

3.4 mm

JACOBSON

13 cm, 5 1/8"
33497-00

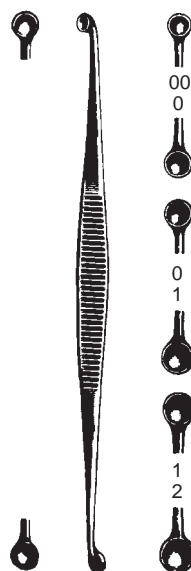

00 2.5 mm
0 3.1 mm

0 3.1 mm
1 3.5 mm

1 3.5 mm
2 4.0 mm

MARTINI

13,5 cm, 5 1/4"
33498-00
33498-01
33498-12

Stößel
Hemostats
Hemostáticos
Pistoni



CASPAR
200 mm, 8"



33509-03
Ø 3 mm



33509-05
Ø 5 mm



33509-08
Ø 8 mm



200 mm, 8"



33510-12
Ø 12 mm



33510-14
Ø 14 mm



33510-16
Ø 16 mm

Stößel, Flachmeißel, Hohlmeißel
 Hemostats, Chisels, Gouges
 Hemostáticos, Cinceles, Gubias
 Pistoni, scalpelli, sgorbie



16 cm, 6 1/4"

2 mm	33600-02
3 mm	33600-03
4 mm	33600-04
5 mm	33600-05
6 mm	33600-06
8 mm	33600-08
9 mm	33600-09
10 mm	33600-10



13,5 cm, 5 1/4"

4 mm	33602-04
6 mm	33602-06
8 mm	33602-08
10 mm	33602-10
12 mm	33602-12
14 mm	33602-14
16 mm	33602-16



13,5 cm, 5 1/4"

33604-04
33604-06
33604-08
33604-10
33604-12
33604-14
33604-16



13,5 cm, 5 1/4"

33605-04
33605-06
33605-08
33605-10
33605-12
33605-14
33605-16

 ALEXANDER
 17 cm, 6 3/4"

33610-04	4 mm
33610-06	6 mm
33610-08	8 mm
33610-10	10 mm
33610-12	12 mm
33610-14	14 mm

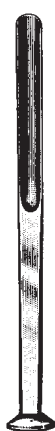
 ALEXANDER
 17 cm, 6 3/4"

33611-04	4 mm
33611-06	6 mm
33611-08	8 mm
33611-10	10 mm
33611-12	12 mm
33611-14	14 mm



 PARTSCH
 13,5 cm, 5 1/4" mm 17 cm, 6 3/4"

33620-02	2	33622-02
33620-03	3	33622-03
33620-04	4	33622-04
33620-05	5	33622-05
33620-06	6	33622-06
33620-07	7	33622-07
33620-08	8	33622-08

 PARTSCH
 13,5 cm, 5 1/4" mm 17 cm, 6 3/4"

33623-02	2	33625-02
33623-03	3	33625-03
33623-04	4	33625-04
33623-05	5	33625-05
33623-06	6	33625-06
33623-07	7	33625-07
33623-08	8	33625-08

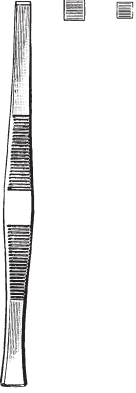
Flachmeißel, Hohlmeißel
Chisels, Gouges
Cinceles, Gubias
Scalpelli, sgorbie



PASSOW
12 cm, 4 3/4"
33626-35 3,5 mm
33626-25 2,5 mm



BRÜNINGS-LUCAS
16 cm, 6 1/4"
33627-04 4 mm
33627-06 6 mm

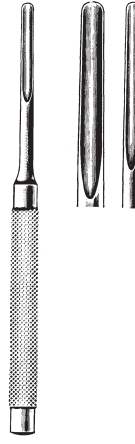

BRÜNINGS-LUCAS
16 cm, 6 1/4"
33628-03 3 mm
33628-05 5 mm



STILLE
20 cm, 8"
33630-06 6 mm
33630-08 8 mm
33630-10 10 mm
33630-12 12 mm
33630-15 15 mm
33630-20 20 mm
33630-25 25 mm
33630-30 30 mm



STILLE
20 cm, 8"

33631-10 6 mm
33631-12 8 mm
33631-15 10 mm
33631-20 12 mm
33631-25 15 mm
33631-30 20 mm



STILLE
20 cm, 8"

33632-06 6 mm
33632-08 8 mm
33632-10 10 mm
33632-12 12 mm
33632-15 15 mm
33632-20 20 mm
33632-25 25 mm
33632-30 30 mm



STILLE
20 cm, 8"

33633-06 6 mm
33633-08 8 mm
33633-10 10 mm
33633-12 12 mm
33633-15 15 mm
33633-20 20 mm
33633-25 25 mm
33633-30 30 mm



STILLE
20 cm, 8"

33634-06 6 mm
33634-08 8 mm
33634-10 10 mm
33634-12 12 mm
33634-15 15 mm
33634-20 20 mm
33634-25 25 mm
33634-30 30 mm

Osteotome, Hohlmeißel
 Chisels, Gouges
 Cinceles, Gubias
 Scalpelli, sgorbie

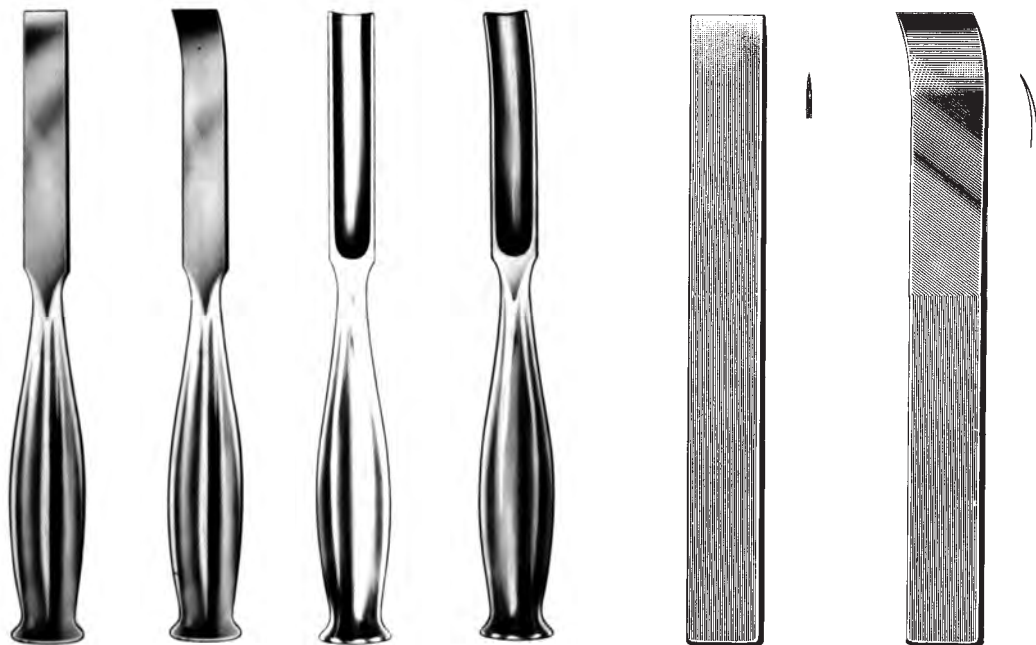

SMITH-PETERSEN
 20 cm, 8"

6 mm	33644-06	33645-06	33647-06	
9 mm	33644-09	33645-09	33647-09	33649-09
13 mm	33644-13	33645-13		
14 mm			33647-14	33649-14
16 mm	33644-16	33645-16	33647-16	33649-16
19 mm	33644-19	33645-19	33647-19	33649-19
25 mm	33644-25	33645-25	33647-25	33649-25
32 mm	33644-32	33645-32	33647-32	33649-32

LAMBOTTE

24 cm, 9 1/2"

23 cm, 9"

33650-04	4 mm	33651-04
33650-06	6 mm	33651-06
33650-08	8 mm	33651-08
33650-10	10 mm	33651-10
33650-13	13 mm	33651-13
33650-16	16 mm	33651-16
33650-18	18 mm	33651-18
33650-20	20 mm	33651-20
33650-25	25 mm	33651-25
33650-30	30 mm	33651-30
33650-38	38 mm	33651-38
33650-44	44 mm	33651-44
33650-50	50 mm	33651-50

Osteotome, Hohlmeißel
 Chisels, Gouges
 Cinceles, Gubias
 Scalpelli, sgorbie



MINI-LAMBOTTE

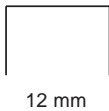
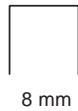

12,5 cm, 5"	mm	17 cm, 6 3/4"
33654-02	2	33652-02
33654-03	3	33652-03
33654-04	4	33652-04
33654-06	6	33652-06
33654-08	8	33652-08
33654-10	10	33652-10
33654-12	12	33652-12
33654-15	15	33652-15

Hohlmeißel mit Ferrozellgriff
 Gouges with Ferrozell-Handle
 Gubias con mango de Ferrozell
 Sgorbie con manico di Ferrozell

8 mm



COBB
 28 cm, 11"
 33656-28

8 mm



COBB
 28 cm, 11"
 33657-28

8 mm



COBB
 28 cm, 11"
 33658-28

8 mm



COBB
 28 cm, 11"
 33659-28

Osteotome, Hohlmeißel mit Ferrozell-Griff
 Chisels and Gouges with Ferrozell-Handle
 Gubias con mango de Ferrozell
 Osteotomo, con manico di Ferrozell



LEXER
 22 cm, 8 3/4"

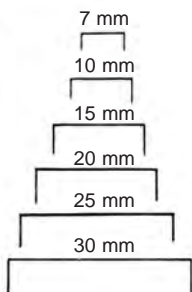

33660-07	7 mm	33661-07
33660-10	10 mm	33661-10
33660-15	15 mm	33661-15
33660-20	20 mm	33661-20
33660-25	25 mm	33661-25
33660-30	30 mm	33661-30

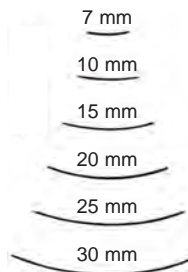

LEXER
 22 cm, 8 3/4"



LEXER MINI
 18 cm, 7"

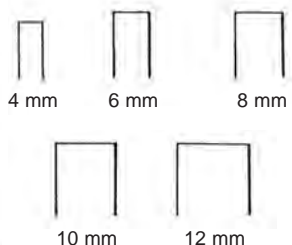

33664-04	4 mm	33665-04
33664-06	6 mm	33665-06
33664-08	8 mm	33665-08
33664-10	10 mm	33665-10
33664-12	12 mm	33665-12

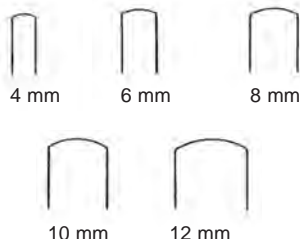

LEXER MINI
 18 cm, 7"

Flachmeißel, Hohlmeißel
 Chisels, Gouges
 Cinceles, Gubias
 Scalpelli, sgorbie



20 mm

33665-24
 24,5 cm, 9 3/4"



16 mm

33665-26
 26,5 cm, 10 1/2"



ZIELKE 23 cm, 9"
 33665-55 5,5 mm
 33665-90 9,0 mm



9 mm

22 cm, 8 3/4"
 33666-22

Hohlmeißel mit NOVOTEX-Griff
 Gouges with Novotex-Handle
 Gubias con mango de Novotex
 Sgorbie con manico di Novotex

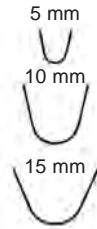

25 cm, 10"

33669-05	5 mm	33670-05
33669-10	10 mm	33670-10
33669-15	15 mm	33670-15

Flachmeißel, Hohlmeißel
 Chisels, Gouges
 Cinceles, Gubias
 Scalpelli, Sgorbie



HOKE

	14 cm, 5 1/2"
33668-03	3 mm
33668-05	5 mm
33668-06	6 mm
33668-08	8 mm
33668-09	9 mm
33668-13	13 mm
33668-16	16 mm
33668-19	19 mm



HIBBS

	24 cm, 9 1/2"
33670-06	6 mm
33670-09	9 mm
33670-13	13 mm
33670-16	16 mm
33670-19	19 mm
33670-25	25 mm
33670-32	32 mm



HIBBS

	24 cm, 9 1/2"
33671-06	6 mm
33671-09	9 mm
33671-13	13 mm
33671-16	16 mm
33671-19	19 mm
33671-25	25 mm
33671-32	32 mm



HIBBS

	24 cm, 9 1/2"
33672-06	6 mm
33672-09	9 mm
33672-13	13 mm
33672-16	16 mm
33672-19	19 mm
33672-25	25 mm
33672-32	32 mm



HIBBS

	24 cm, 9 1/2"
33673-06	6 mm
33673-09	9 mm
33673-13	13 mm
33673-16	16 mm
33673-19	19 mm
33673-25	25 mm
33673-32	32 mm



HIBBS

	24 cm, 9 1/2"
33675-06	6 mm
33675-09	9 mm
33675-13	13 mm
33675-16	16 mm
33675-19	19 mm
33675-25	25 mm
33675-32	32 mm

Meißel
Chisels
Cinceles
Scalpelli

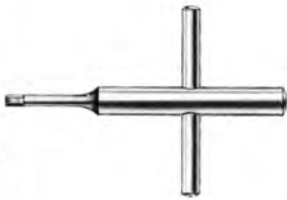

33676-02
9 cm, 3 1/2"
Spannschlüssel
Key
Llave
Clé
Chiave



5 mm
33676-05
8,5 mm, 3.4"



10 mm
33676-10
8,5 mm, 3.4"



16 mm
33676-16
8,5 mm, 3.4"



25 mm
33676-25
8,5 mm, 3.4"

Meißelklingen
auswechselbar
Chisel blades
interchangeable
Hojas de cincel
intercambiables
Lame intercambiabili

33676-01
18,5 cm, 7 1/4"
Griff allein
Handle only
Mango suelto
Manico solo



5 mm
33677-05
8,5 mm, 3.4"



10 mm
33677-10
8,5 mm, 3.4"



16 mm
33677-16
8,5 mm, 3.4"



25 mm
33677-25
8,5 mm, 3.4"

Osteotomklingen
auswechselbar
Osteotome blades
interchangeable
Hojas de osteótomo
intercambiables
Lame per osteotomia
intercambiabili

Schädelspalter, Rachiotom, Sternummeißel, Osteotom, Muskelhaken
 Skull breaker, Rachiotome, Sternum Chisel, Osteotome, Muscle hooks
 Cincel rompe-cráneo, Raquiótomos, Cinceles de esternón, Osteotomo, Ganchos musculare
 Divisore per cranio, Rachiotomi, Scalpello per sterno, Osteotomo, Uncino per muscoli



LBSCHER
 33678-24
 24,5 cm, 9 3/4"



33679-13
 13 cm, 5 1/8"

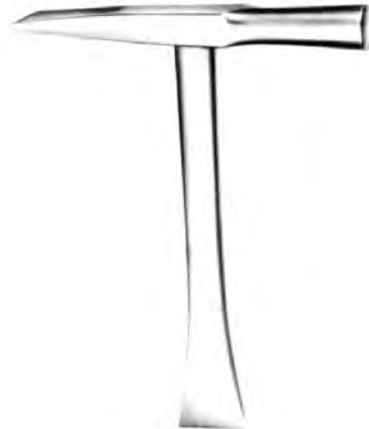

33680-22
 14 cm, 5 1/2"



33682-22
 22 cm, 8 3/4"



19902-10
 10 cm, 4"



19903-00

Meißel, Sektionsnadeln
Chisels, Post mortem needles
Cinceles, Agujas para autopsia
Scalpelli, Aghi per autopsia



89146-20 20 cc
110 x 20 mm

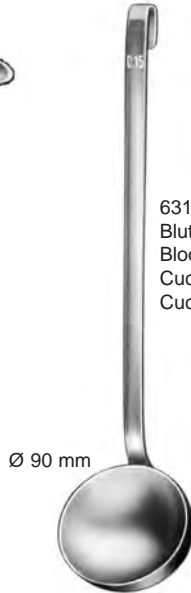

Ø 90 mm

63174-00
Blutschöpfer, 150 ccm
Blood scoop, 9 cu. inches
Cucharra p / sangre
Cucchiaio per sangue



BRUNETTI
28,5 cm, 11 1/4"

33682-01	33682-02
links	rechts
left	right
izquierdo	derecho
sinistra	destra

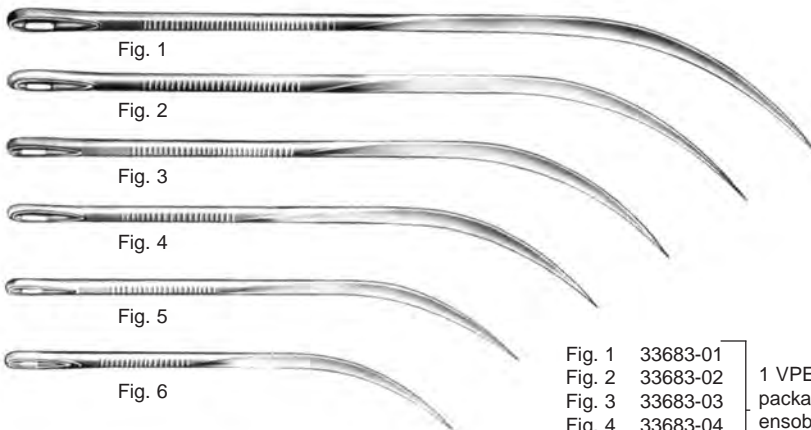

Fig. 1

Fig. 2

Fig. 3

Fig. 4

Fig. 5

Fig. 6

Fig. 1	33683-01	1 VPE = 12 Stk. package of 12 ensobres de 12 confezione di 12
Fig. 2	33683-02	
Fig. 3	33683-03	
Fig. 4	33683-04	
Fig. 5	33683-05	
Fig. 6	33683-06	

Obduktionsbesteck
 Post Mortem Set
 Estuches para Autopsia
 Astucci per Autopsia



33684-00

Kleines Besteck, Holzetui, enthaltend:

- 4 Skalpelle
- 1 Knorpelmesser
- 1 Inzisionsschere, 13 cm (5 1/8")
- 1 Anatomische Pinzette, 13 cm (5 1/8")
- 1 Amputationssäge Charrière
- 1 Hammer
- 1 Meißel
- 2 doppelte Muskelhaken
- 2 doppelte Tubuli
- 2 Knopfsonden, 13 cm (5 1/8")
- 3 Wundnadeln

Small set, wooden case, containing:

- 4 Dissecting Knives
- 1 Cartilage Knife
- 1 Incision Scissors, 13 cm (5 1/8")
- 1 Dissecting Forceps, 13 cm (5 1/8")
- 1 Amputation Saw Charrière
- 1 Mallet
- 1 Chisel
- 2 Retractors, double ended
- 2 Blow pipes, double
- 2 Probes, 13 cm (5 1/8")
- 3 Suture Needles

Modelo pequeño, estuche de madera, conteniendo:

- 4 Escalpelos
- 1 Cuchillo para cartilago
- 1 Tijera de incision, 13 cm (5 1/8")
- 1 Pinza para disección, 13 cm (5 1/8")
- 1 Sierra de amputación Charrière
- 1 Martillo
- 1 Escoplo
- 2 Separadores de 2 gárfios, dobles
- 2 Tubos insufladores, dobles
- 2 Estiletos olivares, 13 cm (5 1/8")
- 3 Agujas para sutura

Modelo piccolo, astuccio di legno, composto da:

- 4 Bisturi
- 1 Coltello per cartilagine
- 1 Forbice per incisione, 13 cm (5 1/8")
- 1 Pinza anatomica, 13 cm (5 1/8")
- 1 Sega per amputazione, Charrière
- 1 Martello
- 1 Scalpello
- 2 Divaricatori con 2 ganci, doppi
- 2 Tubi inalatori, doppi
- 2 Specilli bottonuti, doppi, 13 cm (5 1/8")
- 3 Aghi per sutura

Hämmer
Bone Hammers and Mallets
Martillos y mazos
Martelli

Ø 25 mm



GERZOG
18 cm, 7"
33686-25 250 g

Ø 38 mm

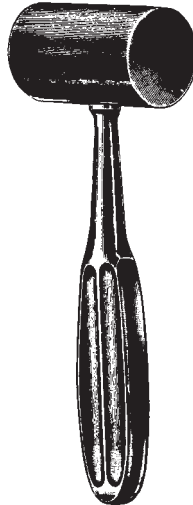

KIRK
19 cm, 7 1/2"
33687-75 750 g

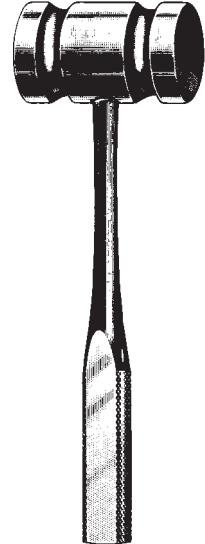

26,5 cm, 10 1/2"
33688-45 450 g
33689-90 900 g

Ø 30 mm

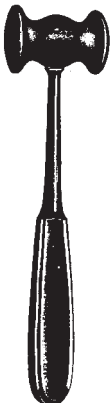

COLLIN
20 cm, 8"
33690-22 220 g

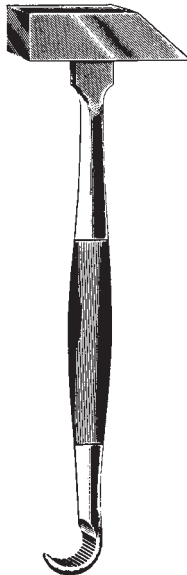

33699-00
23,5 cm, 9 1/4"
480 g

Ø 25 mm



135 g
33694-01 18,5 cm, 7 1/4"
33694-03 Ersatzbacken
Nylon Caps
Tapas de repuesto
Placche di ricambio

Hämmer
Bone Hammers and Mallets
Martillos y mazos
Martelli

massiv, mit auswechselbaren Ferrozellbacken
solid, with interchangeable Ferrozell jaws
macizo, con tapas intercambiables de Ferrozell
solido, con placche intercambiabili in Ferrozell



WILLIGER
24 cm, 9 1/2"
33691-34 340 g

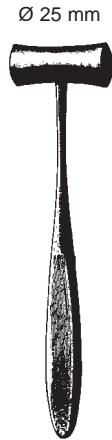

LUCAE
19 cm, 7 1/2"
33692-26 260 g



33693-33
Paar Ersatzbacken
Pair spare jaws
par de tapas de repuesto
Coppia di placche di ricambio

33693-34
Satz Ringe
Set rings
juego de anillos
Set anelli

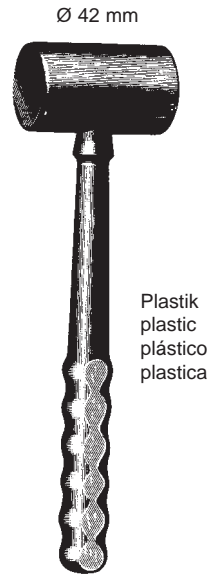

26 cm, 10 1/4"
33695-40 400 g



QUISLING
33696-75

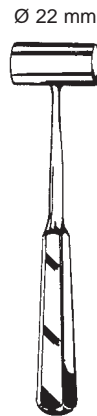

PARTSCH
33698-98
18 cm, 7"
199 g



33699-17
26,5 cm, 10 1/2"
530 g

Hämmer
Bone Hammers and Mallets
Martillos y mazos
Martelli

Ø 30 mm



33700-01-01
Ersatzbacken
Nylon Caps
Tapas de repuesto
Placche di ricambio

24,5 cm, 9 3/4" 215 g
33700-01

Ø 10 mm

Ø 23 mm



Kopf aus
Implantatwerkstoff
Head made of
material used for implants
Cabeza de
material de implantación
Testa in
materiale per impianti

23 cm, 9" 350 g
33700-02

Ø 45 mm



BERGMANN
24 cm, 9 1/2" 300 g
33700-03

Ø 30 mm



BERGMANN
23 cm, 9" 300 g
33700-04

Hämmer
Bone Hammers and Mallets
Martillos y mazos
Martelli

Ø 30 mm



COTTLE
18 cm, 7" 240 g
33700-05

Ø 40 mm



HEATH
18 cm, 7" 700 g
33700-06

Ø 40 mm



OMBREDANNE
25 cm, 10" 700 g
33700-07

Ø 27 mm



HAJEK
21 cm, 8 1/4" 140 g
33700-08

Raspatorien
 Periosteal Elevators
 Periostótomos
 Periostotomi

12,5 mm



FARABEU
 33702-15
 15 cm, 5.9"

12,5 mm



FARABEU
 33703-15
 15 cm, 5.9"

11 mm

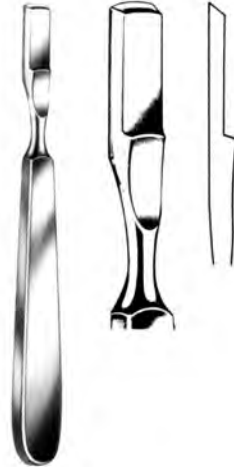

FARABEU-COLLIN
 33704-01
 15,5 cm, 6"

11 mm

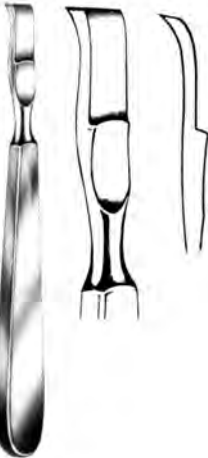

FARABEU-COLLIN
 33704-02
 15,5 cm, 6"



LAMBOTTE
 21 cm, 8 1/4"
 33705-05 5 mm
 33705-10 10 mm
 33705-15 15 mm
 33705-20 20 mm
 33705-25 25 mm

18 mm



SEDILLOT
 18 cm, 7"
 33706-18

Raspatorien
 Periosteal Elevators
 Periostótomos
 Periostotomi

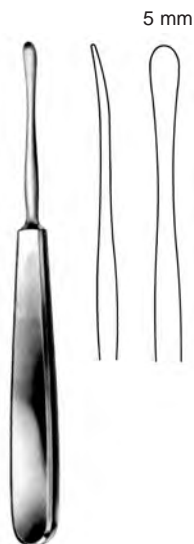

SEBILEAU
 17,5 cm, 7"
 33707-17

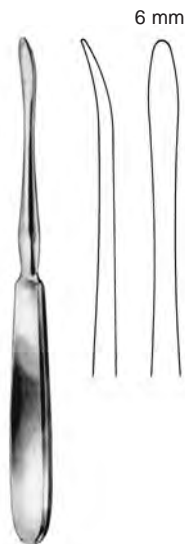

QUERVAIN
 19,5 cm, 7 3/4"
 33708-19

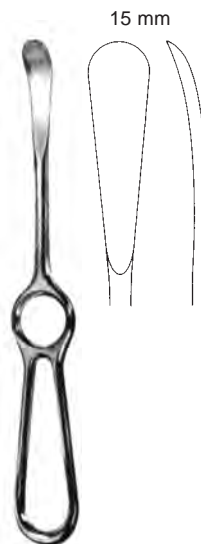

SEDILLOT
 21 cm, 8 1/4"
 33709-21



LANGENBECK
 19 cm, 7 1/2"
 33710-19



LANGENBECK
 18 cm, 7"
 33711-18



LANGENBECK
 20 cm, 8"
 33711-20 8 mm
 33711-21 10 mm

Raspatorien, Elevatoren
Raspatories, Elevators
Periostótomos, Elevadores
Periostotomi, Elevatori

4 mm



WILLIGER
33711-16
16 cm, 6 1/4"

6,5 mm



WILLIGER
33712-16
16 cm, 6 1/4"

5 mm



WILLIGER
33713-16
16 cm, 6 1/4"

5,5 mm



WILLIGER
33713-17
17 cm, 6 3/4"

5 mm

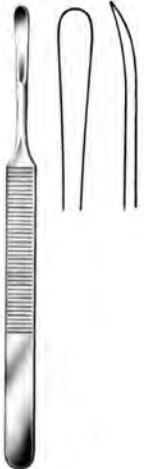

KÖNIG
33714-15
15,5 cm, 6"

12 mm

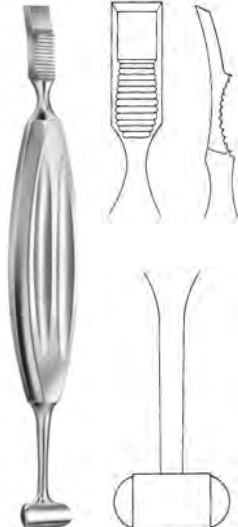

ALEXANDER
33715-20
21 cm, 8 1/4"



MOLT
33716-18
18 cm, 7"

Raspatorien, Elevatoren
Raspatories, Elevators
Periostótomos, Elevadores
Periostotomi, Elevatori

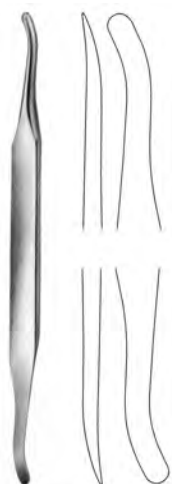

SELDIN
33717-19-01
19,5 cm 7 3/4"

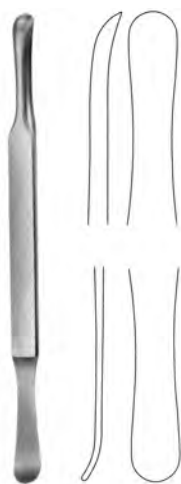

SELDIN
33717-19-02
19,5 cm 7 3/4"



JOSEPH
33718-16
16 cm, 6 1/4"



FOMON
33719-17
17 cm, 6 3/4"

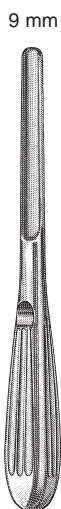

BOIES
33720-19
19 cm, 7 1/2"



GORNEY
33720-21
21 cm, 8 1/4"

Raspatorien, Elevatoren
 Periosteal Elevators
 Periostótomos, Elevadores
 Periostotomi, Elevatori

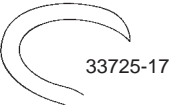
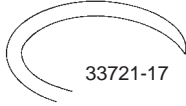

DOYEN
 17 cm, 6 3/4"

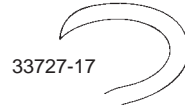
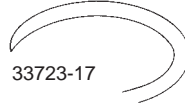

DOYEN
 17 cm, 6 3/4"



DOYEN
 33728-24 33729-24
 24 cm 9 1/2"



12 mm



33729-01
 17,5 cm
 7"

12 mm



33729-02
 21 cm
 8 1/4"

12 mm



33729-03
 17,5 cm
 7"

13 mm



33729-04
 21 cm
 8 1/4"

15 mm



33729-05
 20,5 cm
 8"

15 mm



33729-06
 20,5 cm
 8"



33729-07
 22,5 cm
 8.9"

SEMB

Elevatoren, Raspatoren
Elevators, Raspatories
Elevadores, Periostótomos
Elevatori, Periostotomi



MATSON-ALEXANDER
33731-22
22 cm, 8 3/4"



MATSON
33733-22
22 cm, 8 3/4"



33740-19
19 cm, 7 1/2"



33741-18
18,5 cm, 7 1/4"



33742-18
18,5 cm, 7 1/4"



33743-18
18,5 cm, 7 1/4"

Elevatoren, Raspatoren
 Elevators, Raspatories
 Elevadores, Periostótomos
 Elevatori, Periostotomi

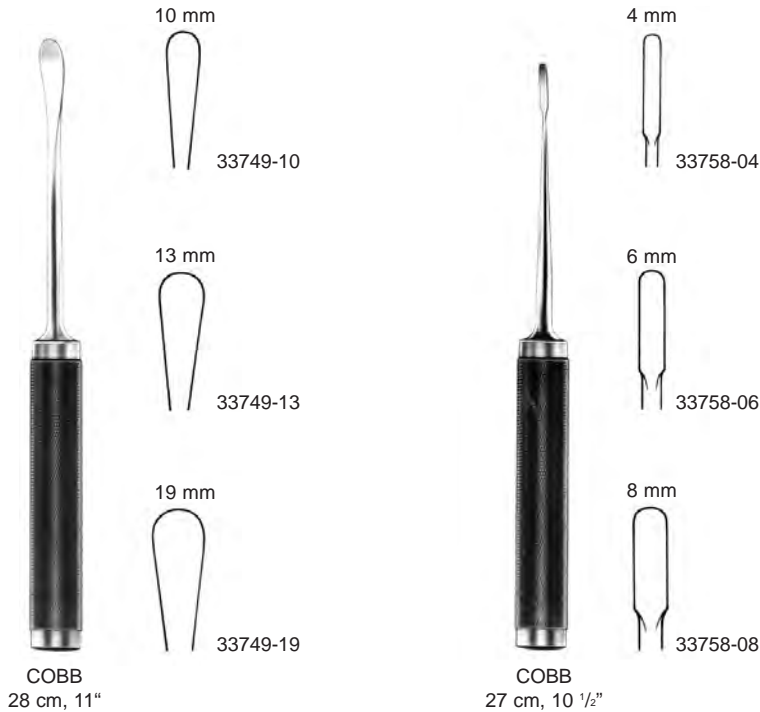
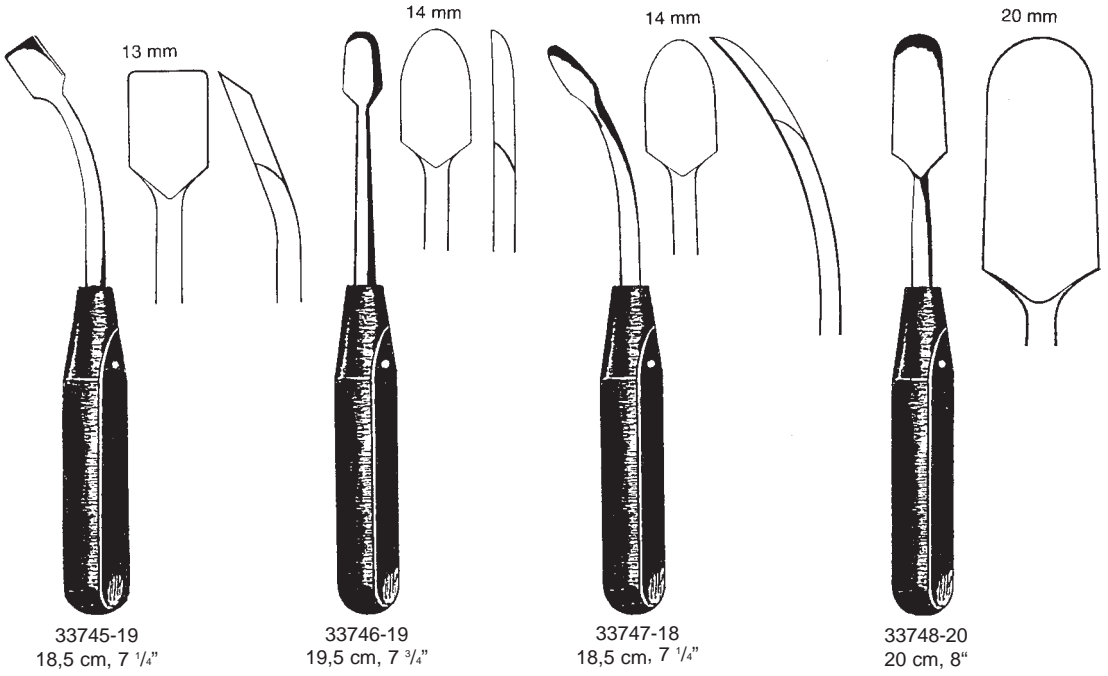

Elevatoren
Elevators
Elevadores
Elevatori

scharf
sharp
cortante
tagliente



SAYRE
17 cm, 6 $\frac{3}{4}$ "
33758-01

stumpf
blunt
romo
smusso



SAYRE
17 cm, 6 $\frac{3}{4}$ "
33758-02

Elevatoren, Knochenheber
 Elevators, Bone Levers
 Elevadores para huesos
 Elevatori, Elevatori per ossa

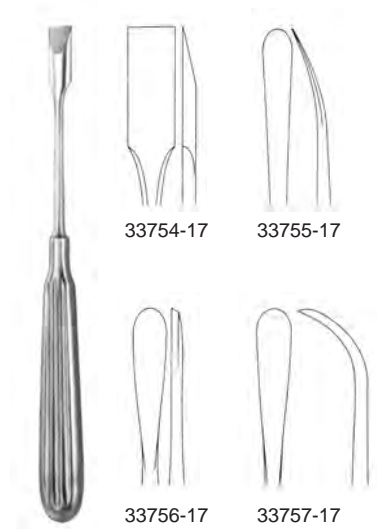

ADSON
 17 cm, 6 3/4"

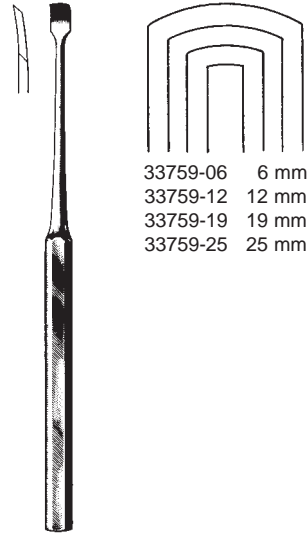

KEY
 33759-06 - 33759-25
 19 cm, 7 1/2"

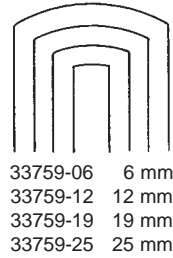

CHANDLER
 33763-01 19,0 cm 7 1/2"
 33763-02 20,3 cm 8"
 33763-03 22,9 cm 9"
 33763-04 25,4 cm 10"



CREGO
 33760-01
 20 cm, 8"



33760-02



33760-03



ALDERDYCE
 33761-21
 21 cm, 8 1/4"

Elevatoren, Knochenhebel
Elevators, Bone Levers
Elevadores para huesos
Elevatori, Elevatori per ossa

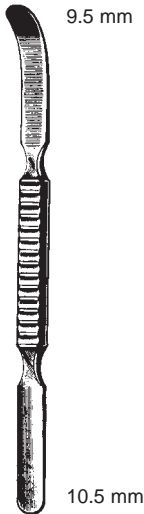

WATSON-CHEYNE
33765-17
17,5 cm, 7"

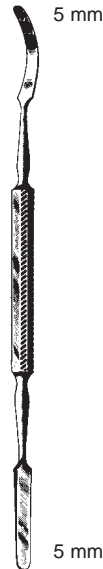

MC DONALD
33767-19
19 cm, 7 1/2"

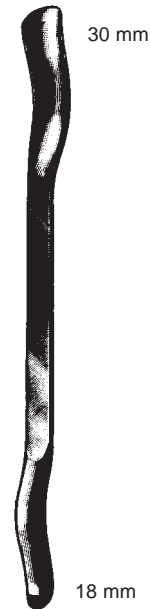

MURPHY-LANE
33769-30
30 cm, 11 3/4"



BENNETT
33771-71
65x260 mm



BENNETT
33771-73
45x260 mm

Knochenhebel
Bone Levers
Elevadores para huesos
Elevatori per ossa

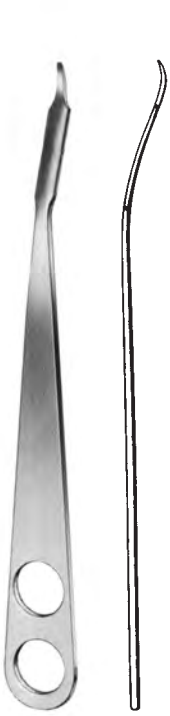

HOHMANN
33801-08 8 mm
33801-12 12 mm

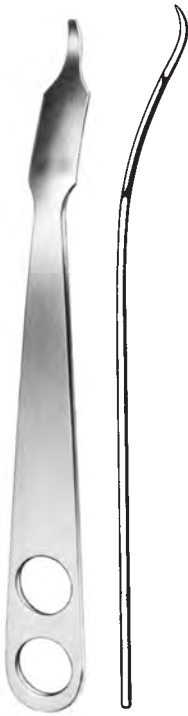

HOHMANN
33801-18
18 mm, 3/4"

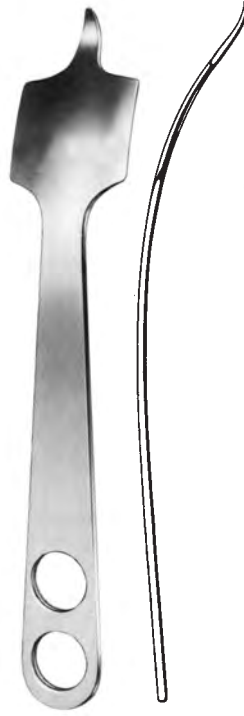

HOHMANN
33801-43
43 mm, 1 3/4"



HOHMANN
33801-70
70 mm, 2 3/4"



KÖNIG
33802-01
15 cm, 6"



KÖNIG
33802-02
15 cm, 6"



33802-14
14 cm, 5 1/2"



33803-05
15 cm, 6"



33803-07
15 cm, 6"

Knochenhebel
Bone Levers
Elevadores para huesos
Elevatori per ossa



HOHMANN
33803-43 43 mm

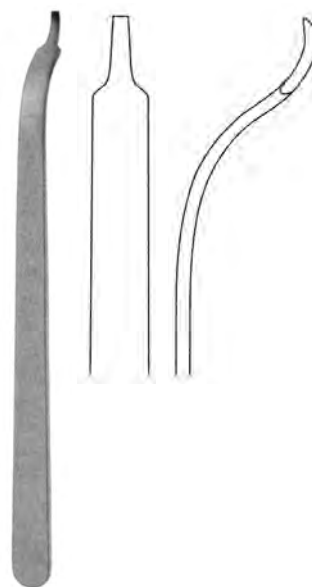

BUCK-GRAMCKO
33804-15 15 mm



HOHMANN
33805-22 22 mm



HOHMANN
33805-33 33 mm



HOHMANN
33807-24 24 mm



HOHMANN
33809-22 22 mm

Knochenhebel
 Bone Levers
 Elevadores para huesos
 Elevatori per ossa

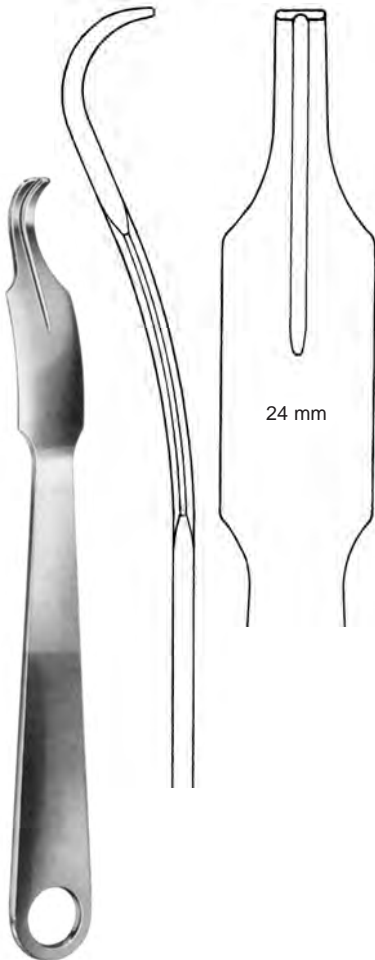

LANGE-HOHMANN
 33810-24
 25 cm, 10"



HOHMANN mini
 16 cm, 6 1/4"

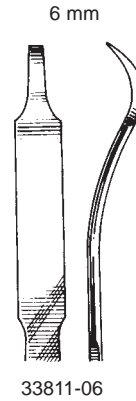

33811-06

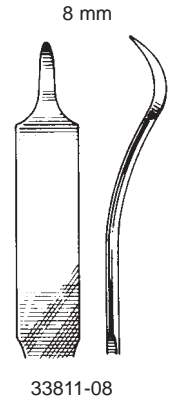

33811-08

Knochenhebel
Bone Levers
Elevadores para huesos
Elevatori per ossa

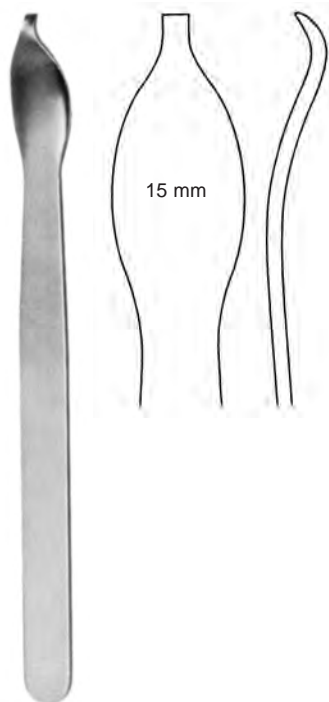

33812-16
16 cm, 6 1/4"

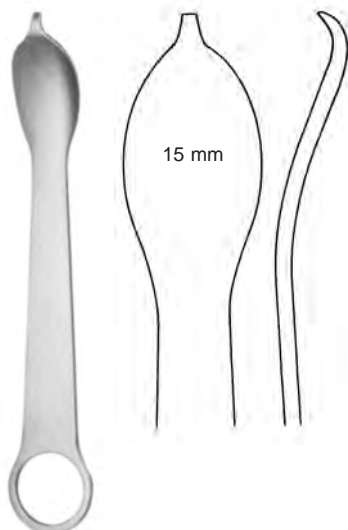

33813-12
12 cm, 4 3/4"

Knochenheber
Bone Levers
Elevadores para huesos
Elevatori per ossa

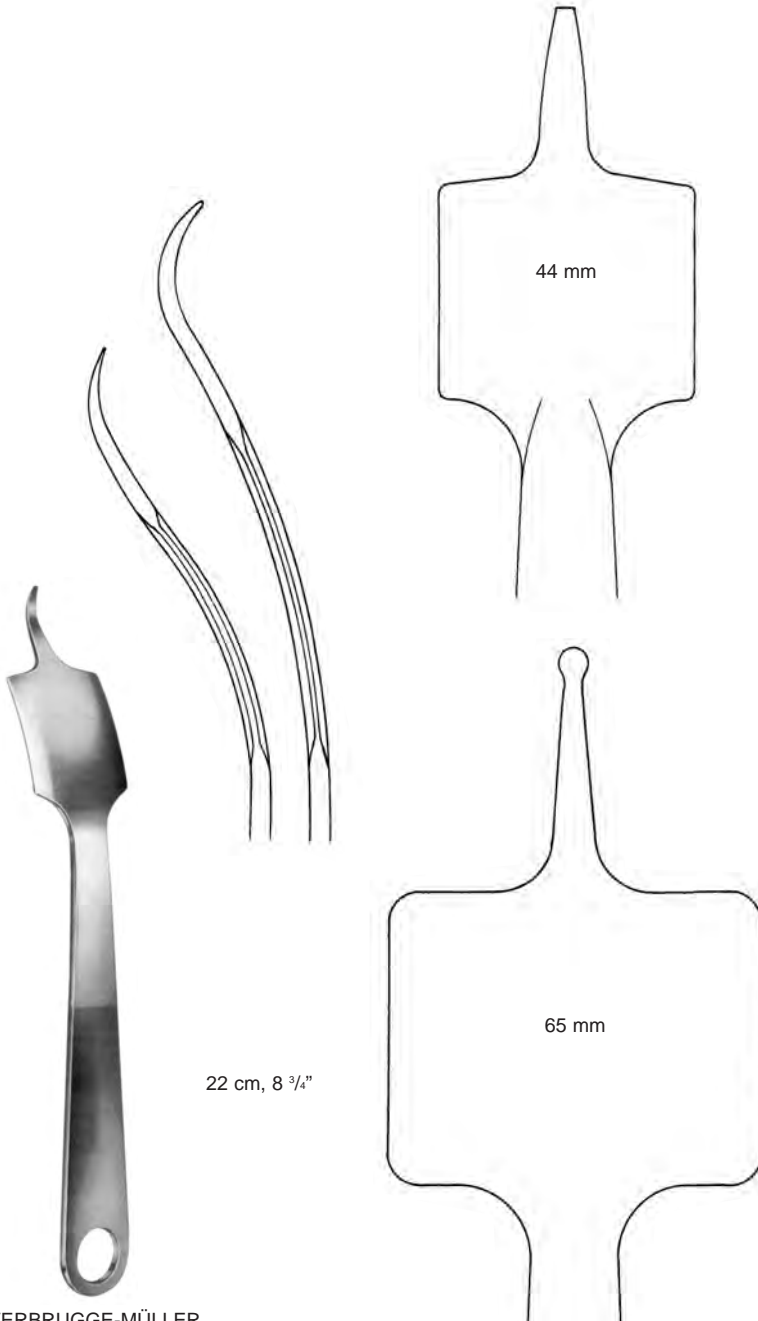

VERBRUGGE-MÜLLER
33814-44 24,0 cm, 9 ¹/₂"
33814-65 25,5 cm, 10"

Knochenhebel
Bone Levers
Elevadores para huesos
Elevatori per ossa

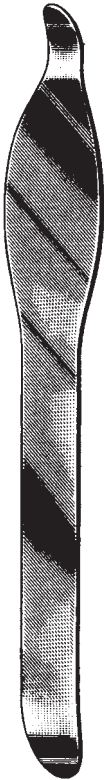

BLOUNT
33823-26
26 cm, 10 1/4"

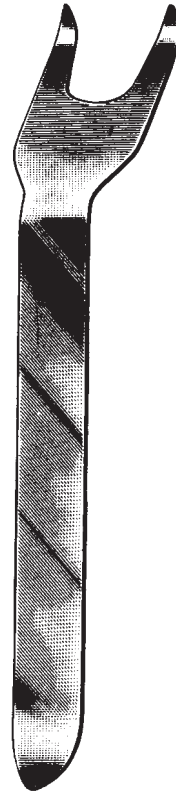

BLOUNT
33825-26
26 cm, 10 1/4"

Bauchdeckenhalter, Knochenheber, Meniskushaken
 Abdominal Retractor, Bone Levers, Meniscus Retractors
 Separador abdominal, Elevadores p. huesos, Separadores para menisco
 Divaricatori abdominali, Elevatori per ossa, Divaricatori per il menisco

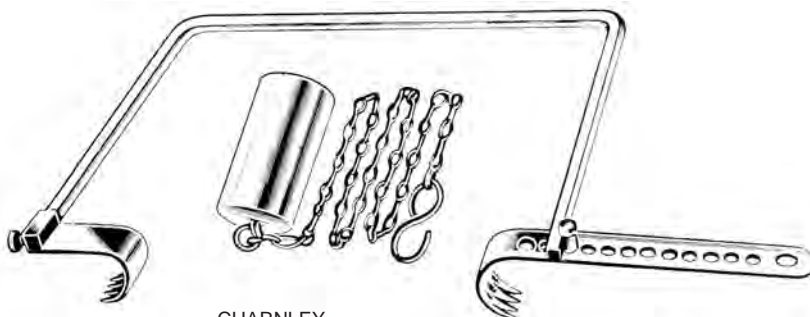

CHARNLEY
33826-00

33826-01 spitz, gerieft
 pointed tip, serrated
 punta aguda, dentada
 punta acuta, zigrinata

33826-02 stumpf, gerieft
 blunt tip, serrated
 punta roma, dentada
 punta smussa, zigrinata

33826-03 stumpf, glatt
 blunt tip, smooth
 punta roma, lisa
 punta smussa, liscia

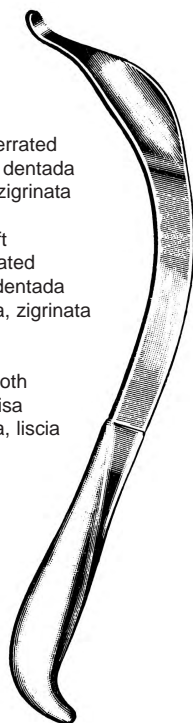

AUFRANC-COBRA
26 cm 10 1/4"



BLOUNT
33827-17
17,5 cm 7"

Knochenheber
Bone Levers
Elevadores p. huesos
Elevatori per ossa



LANE TRETOWAN
33828-21
21,5 cm 8 1/2"



LANE
33829-25
25,5 cm 10"



BRISTOW
33830-23
23 cm 9"

Knochenheber, Meniskushaken
Bone Levers, Meniscus Retractors
Elevadores p. huesos, Separadores para menisco
Elevatori per ossa, Divaricatori per il menisco

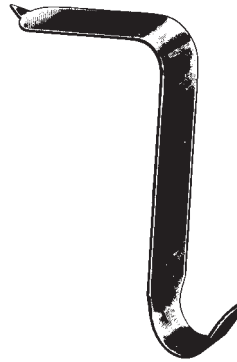

TAYLOR
16,5 cm, 6 1/2"
33831-16 75x30 mm
33833-16 100x30 mm



12 x 13 mm
33832-01



52 x 13 mm
33832-02



32 x 19 mm
33832-03

48 x 19 mm
33832-04

57 x 19 mm
33832-05

SMILLIE
14 cm, 5 1/2"

Sehenschäler, Sehnenfaßspinzette, Sehnenhaltezange, Sehnenfaßinstrumente
 Tendon seizing instruments
 Instrumentos para coger tendones
 Enucleatore di tendine, Strumenti per afferrare tendini



SMILLIE
 33910-17
 17 cm, 6 3/4"

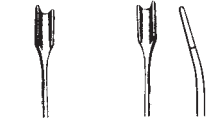

33911-17 17 cm 6 3/4"
 33913-17 17 cm 6 3/4"

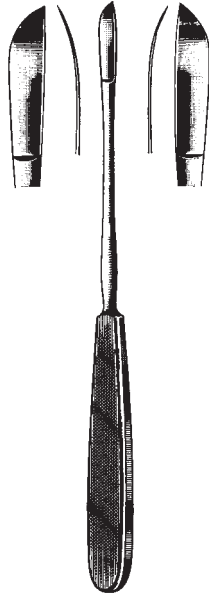

NEFF
 33921-22 - 33923-22
 22 cm, 8 3/4"



33950-01 3 mm
 33950-02 4 mm
 33950-03 5 mm
 33950-04 6 mm
 33950-05 7 mm

BUNELL
 33950-01 - 33950-05
 15 cm, 6"



LARSEN
 33960-15 - 33960-55
 10 cm, 4"

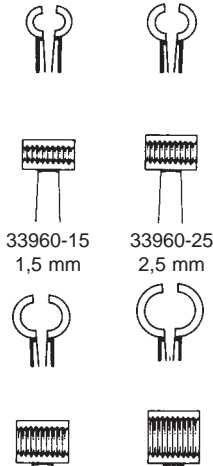

33960-15 1,5 mm
 33960-25 2,5 mm
 33960-45 4,5 mm
 33960-55 5,5 mm



JACKSON
 33961-15
 15 cm, 6"

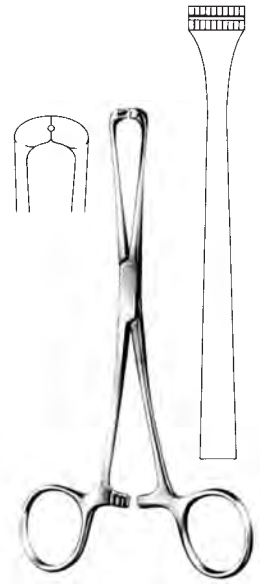

STEINMANN
 33962-16
 16 cm, 6 1/4"

Sehnenfaßinstrumente, Sehnenführer
 Tendon seizing instruments, Tendon passing instr.
 Instrumentos para coger tendones, Instrumento p. el tunel del tendon
 Strumenti per afferrare tendini



33963-12
 12 cm, 4 3/4"



BRAND
 33964-15 - 33964-24



33964-15
 15 cm, 6"



33964-19
 19 cm, 7 1/2"



33964-24
 24 cm, 9 1/2"



BRAND
 33965-15 15 cm, 6"
 33965-19 19 cm, 7 1/2"
 33965-24 24 cm, 9 1/2"



CAROLL
 33966-11
 11 cm, 4 3/8"

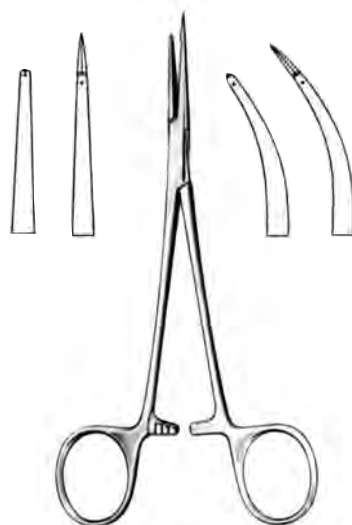

33966-15 15 cm, 6" 33967-15

Sehnenfassinstrumente, Sehnenstripper, Knochenfeilen, Raspeln
 Tendon seizing instruments, Tendon Strippers, Bone Files, Rasps
 Instrumentos para coger tendones, Enucleadores de tendones, Limas, Escofinas
 Strumenti per afferrare tendini, Scollatendini, Lime per ossa, Raspe



KLEINERT-KUTZ
 33967-20
 20 cm, 8"



ø 3 mm
 33968-30
 30 cm, 11 3/4"

ø 6 mm
 33968-60
 50 cm, 19 1/2"

BRAND



biegsam
 malleable
 maleable
 malleabile

BUNELL
 33969-18 18 cm, 7"
 33969-23 23 cm, 9"



biegsamer Schaft
 flexible shaft
 vastago maleabile
 camicia flessibile

BUNELL 23 cm
 33970-01 ø 4,0 mm
 33970-02 ø 4,5 mm
 33970-03 ø 5,5 mm



33971-24
 24,5 cm, 9 3/4"



33972-22
 22 cm, 8 3/4"



PUTTI
 33973-27
 27 cm, 10 1/2"



PUTTI
 33975-30
 30 cm, 11 3/4"



33977-28
 28 cm, 11"

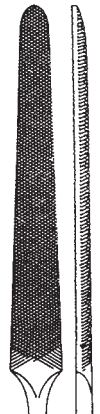

Komprimeter
 Pneumatic Tourniquet
 Torniquete pneumático
 Apparecchio di compressione



34101-01
 compl.

Gerät zur Erzeugung von Bluteere in den Gliedmaßen
 Compression Apparatus for producing blood vacuum in limbs
 Aparato de compresión para producir el vacío de sangre en los miembros
 Vacuometro per determinare vuoti di sangue nelle membra

34101-02
 Pumpe
 Air Pump
 Bomba de aire
 Pompa di aria

34101-03
 Manometer
 Manometer
 Manómetro
 Manometro

34101-04
 Oberarmmanschette
 Cuff for upper arm
 Brazalete (brazo)
 Bracciale
 34101-06 incl.

34101-05
 Oberschenkelmanschette
 Cuff (leg)
 Brazalete (pierna)
 Cosciale
 34101-07 incl.

34101-06
 Polster für Oberarmmanschette 46 x 6 cm (18" x 2.4")
 Bandage cuff for arm 46 x 6 cm (18" x 2.4")
 Brazalete para brazo 46 x 6 cm (18" x 2.4")
 Bracciale per braccio superiore 46 x 6 cm (18" x 2.4")

34101-07
 Polster für Oberschenkelmanschette 55 x 10 cm (21 1/2 x 10")
 Bandage cuff for leg 55 x 10 cm (21 1/2 x 10")
 Brazalete para el fémur 55 x 10 cm (21 1/2 x 10")
 Bracciale per coscia superiore 55 x 10 cm (21 1/2 x 10")

Amputations- und Resektionssägen
 Amputation and Resection Saws
 Sierras para amputación y resección
 Seghe per amputazione e resezione

Staubinde
 Compression bandage
 Vendaje de compresión
 Benda per compressione
 5 m lang / long
 6 cm breit / wide



ESMARCH
 34105-01

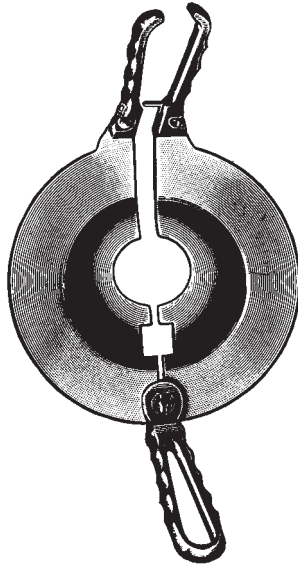

PERCY
 34110-00

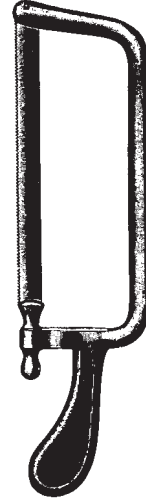

CHARRIERE
 34112-00

34112-01
 12 mm

Ersatzsägeblätter
 Spare saw blades
 Hojas de sierra de
 repuesto
 Lame di ricambio

34112-02
 15 mm

Ersatzsägeblätter
 Spare saw blades
 Hojas de sierra de
 repuesto
 Lame di ricambio

komplett mit 2 Blättern
 complete with 2 blades
 completo con 2 hojas
 completa con 2 lame



mit 3 Sägeblätter
 4 - 6 - 8 mm
 con 3 hojas de repuesto
 with 3 spare blade
 con 3 lame di ricambio

BIER
 34114-39
 40,5 cm, 16"



CHARRIERE
 34116-30
 30 cm, 11 3/4"

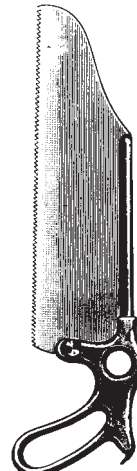

SATTERLEE
 34118-31
 31 cm, 12 1/4"



LANGENBECK
 34120-23
 23 cm, 9"

Nagelausreißzange, Fingerringsägen
 Fcps. f. tearing out finger nails, Finger Ring Saws
 Pinzas para arrancar uñas, Sierras para abrir anillos
 Pinze per lacerazione delle unghie, Seghe per anelli

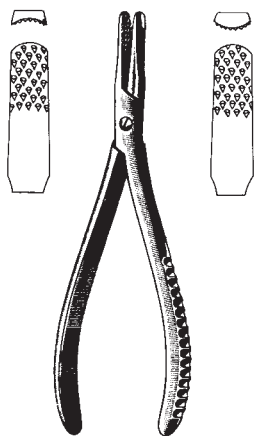

RADOLF

34161-13 13,5 cm, 5 1/4" 3 mm
 34162-13 13,5 cm, 5 1/4" 6 mm

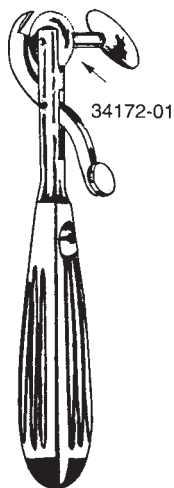

WALTON
 34172-00

Sägeblatt
 Saw blade
 Hoja de sierra
 Lama di ricambio



REDA
 34175-00

Sägeblatt
 Saw blade
 Hoja de sierra
 Lama di ricambio

Bohrapparate
 Bone Hand Drills
 Perforador de mano
 Perforatori a mano

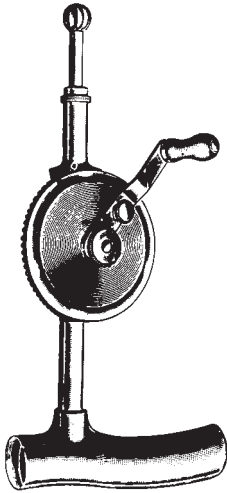

STILLE
 34210-20 20 cm, 8"
 compl. incl. 34212-25 - 34214-16

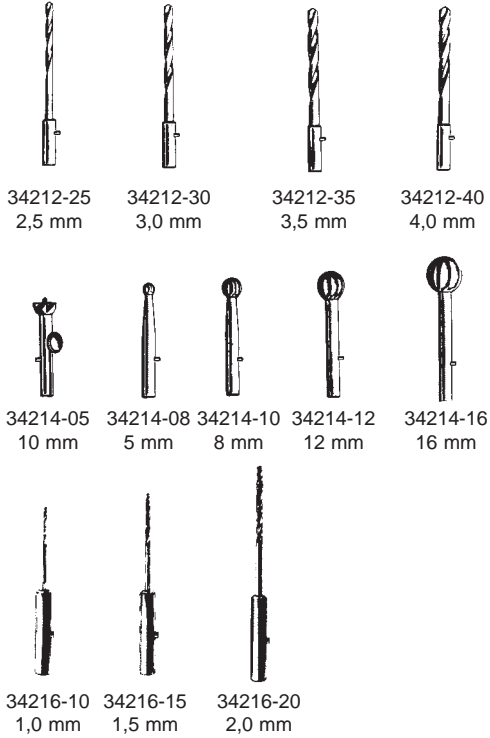

34212-25 2,5 mm
 34212-30 3,0 mm
 34212-35 3,5 mm
 34212-40 4,0 mm

34214-05 10 mm
 34214-08 5 mm
 34214-10 8 mm
 34214-12 12 mm
 34214-16 16 mm

34216-10 1,0 mm
 34216-15 1,5 mm
 34216-20 2,0 mm

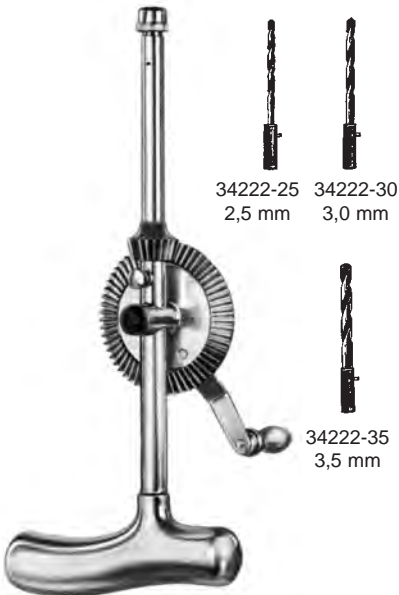

STILLE-SHERMAN
 34220-24 24 cm, 9 1/2"
 compl. incl. 34222-25 - 34222-35



MOORE
 34230-28 28 cm, 11"
 compl. incl. 34232-00

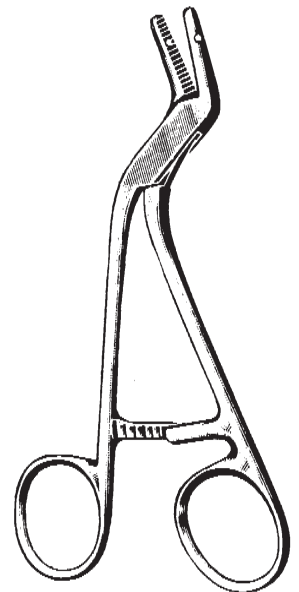

ADSON
 34231-15
 15 cm, 6"

Bohrapparate
 Bone Hand Drills
 Perforador de mano
 Perforatori a mano



34241-00
 Griff allein
 Handle only
 Mango solo
 Manico solo

HUDSON
 34240-27 27 cm, 10 1/2"
 compl. incl. 34242-09, -14, -16, -22,
 34246-00



34242-09
 9 mm



34242-14
 14 mm



34242-16
 16 mm



34242-22
 22 mm



ø 2 mm
 34243-02



CUSHING
 34244-10
 34244-14
 34244-16



ERRICO
 34244-17
 ø 16 mm



MC KENZIE
 34248-00
 ø 13 mm



34246-00
 Verlängerungsstück
 Extension piece
 Pieza alargadera
 Giunto di prolungamento



KIRSCHNER
 34250-00 compl.



34252-00



BUNELL
 34270-00 16 cm, 6 1/4"

34270-01
 Schlüssel
 Wrench
 Llave
 Chiave

Bohrapparat 16 cm (6 1/4"), längsdurchbohrt mit Dreibackenspannfutter und Schlüssel, Spannweite bis 4 mm
 Hand drill, 16 cm (6 1/4"), longitudinally bored, with three-jaw-chuck and key, opening up to 4 mm
 Perforador manual, 16 cm (6 1/4"), taladrado longitudinalmente, con mandril de tres mordazas y llave, abriendo hasta 4 mm
 Perforatore a mano, 16 cm (6 1/4"), con perforazione assiale, con mandrino a tre ganasce e chiave, apertura fino a 4 mm di D.

Bohrapparate, Handgriffe
 Bone Hand Drills, Handles
 Perforador de mano
 Perforatori a mano, manici



RALK
34280-00



REDA
34290-00



34295-00

Spannschlüssel allein
 Key only
 Llave suelta
 Chiave solo



34296-00

Handgriff mit Jacobs-
 spannfutter und
 Spannschlüssel
 Handle with Jacobs chuck
 and key
 Mango con cierre Jacobs,
 de 3 mordazas y llave
 Manico con mandrino di
 Jacobs e chiave

Bohrapparat mit Leichtmetallgehäuse, mit Dreibackenspannfutter und Schlüssel. Spannweite bis D. 6,35 mm
 Hand drill with light metal case, with three-jaw-chuck and key, opening up to D. 6,35 mm
 Perforador manual con caja de aluminio, con mandril de tres mordazas y llave, abriendo hasta 6,35 mm de D.
 Perforatore a mano con cassa in metallo leggero, con mandrino a tre ganasce e chiave, apertura fino a 6,35 mm di D.

Handbohrapparat mit umstellbarem Handgriff, mit Jacobs Dreibackenspannfutter und Schlüssel
 Hand drill with adjustable handle, with Jacobs three-jaw-chuck and wrench
 Perforador de mano en T con cierre Jacobs de 3 mordazas y llave de ajuste
 Perforatore a mano con manico regolabile, con mandrino a tre ganasce di Jacobs e chiave



34296-05

T-Handgriff, verriegelbares schlüsselloses Dreibackenspannfutter, rostfrei
 T-handle, keyless locking chuck
 Mango en T, mordaza sin llave, inox.
 Chiave a T con mandrino a tre ganasce inox



34296-10

Handgriff, Dreibackenspannfutter, inkl. Spannschlüssel rostfrei
 Handle with chuck, including key
 Mango, mordaza incluyendo llave, inox.
 Mandrino a tre ganasce con manico recto completo di chiave di arresto inox



34296-15

"Hudson" T-Handgriff, Schnellkupplung
 Hudson T-handle with fast gripping chuck
 Mango en T, acople rápido
 Hudson: mandrino con manico a T
 Ganasce con raccordo rapido



34296-20

Schnellkupplungs T-Handgriff, groß
 T-handle with fast gripping chuck, large
 Mango en T, acople rápido, grande
 Mandrino a T manico grande
 Raccordo rapido

Schnellkupplungs-Handgriffe, Bohrapparat elektr.
 Handles with quick action chuck, Bone drill electr.
 Perforador electrico y mangos de acople rápido
 Manici con attachi rapidi, Perforatori elettr.



34296-25
 Schnellkupplungs-T-Handgriff
 T-Handle, quick-action
 Mango en T, acople rápido
 Mandrino a T con raccordo rapido



34296-30
 Schnellkupplungs-Handgriff
 groß mit Hartgewebegriff
 Handle, quick-action, large,
 handle made of very hard fibre
 Mango de acople rápido,
 grande, de material extraduro
 Mandrino grande rapido con
 manico a fibre dure



34296-35
 Schnellkupplungs-Handgriff
 mit Hartgewebegriff
 Handle, quick-action,
 made of very hard fibre
 Mango de acople rápido,
 de material extra-duro
 Mandrino medio rapido con
 manico a fibre dure



34296-40
 Mini Schnellkupplungs-Handgriff
 für „Dental“-Anschluß
 Mini-Handle, quick-action,
 "dental"
 Mini-Mango de acople rápido
 "dental"
 Mini mandrino-rapido con
 impugnatura cilindrica con
 attacco dentale

Bohrer
Drill bits
Taladros
Perforatore



Ø			
1,0 mm	56 mm	34320-10	
1,5 mm	70 mm	34320-15	
2,0 mm	85 mm	34320-20	
2,5 mm	95 mm	34320-25	
2,7 mm	100 mm	34320-27	
3,0 mm	100 mm	34320-30	
3,2 mm	106 mm	34320-32	
3,5 mm	112 mm	34320-35	
4,0 mm	119 mm	34320-40	
4,5 mm	126 mm	34320-45	
5,0 mm	132 mm	34320-50	
6,0 mm	139 mm	34320-60	
7,0 mm	156 mm	34320-70	

Spiralbohrer mit Glattschaft
Twist Drills with round end
Taladros espirales con vástago redondo
Perforatore elicoidale



Ø			
1,0 mm	180 mm	34321-10	
1,5 mm	180 mm	34321-15	
2,0 mm	180 mm	34321-20	
2,5 mm	180 mm	34321-25	
2,7 mm	180 mm	34321-27	
3,0 mm	180 mm	34321-30	
3,2 mm	180 mm	34321-32	
3,5 mm	180 mm	34321-35	
4,0 mm	180 mm	34321-40	
4,5 mm	180 mm	34321-45	
5,0 mm	180 mm	34321-50	
6,0 mm	180 mm	34321-60	
6,5 mm	180 mm	34321-65	
7,0 mm	180 mm	34321-70	
8,0 mm	180 mm	34321-80	
9,0 mm	180 mm	34321-90	
10,0 mm	180 mm	34322-00	

Spiralbohrer mit Glattschaft langes Modell
Twist Drills, long typ
Taladros espirales, largos
Perforatore elicoidale, modello lungo



Ø			
1,1 mm	60 mm	34322-11	
1,5 mm	85 mm	34322-15	
2,0 mm	100 mm	34322-20	
2,5 mm	110 mm	34322-25	
2,7 mm	100 mm	34322-27	
3,2 mm	145 mm	34322-32	
3,5 mm	110 mm	34322-35	
4,5 mm	145 mm	34322-45	

Spiralbohrer mit Schnellkupplungs-Ansatz
Twist Drills, quick-action
Taladros espirales, acople rápido
Perforatore elicoidale con attacco rapido

Pfrieme, Reibahle
 Awl, Reamer
 Escariadores
 Lesine, Punteruoli



34392-14
 14 cm, 5 1/2"



PERTHES
 34393-18
 18 cm, 7"

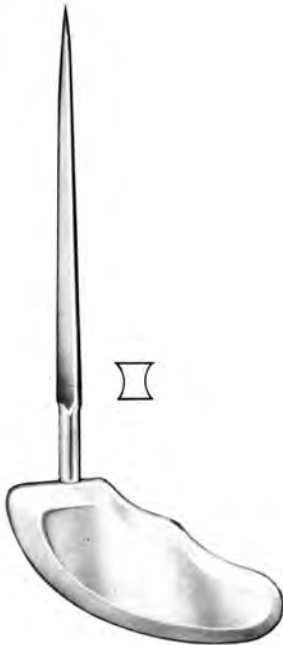

PERTHES
 34393-21
 21 cm, 8 1/4"



34394-14
 14 cm, 5 1/2"

Faßpinzette, Bohrdrahtspender
 Grasping forceps, Support for sterilisation
 Pinzas para coger, Soporte de esterilización
 Pinze per afferrare, Supporto per la sterilizzazione



34439-00

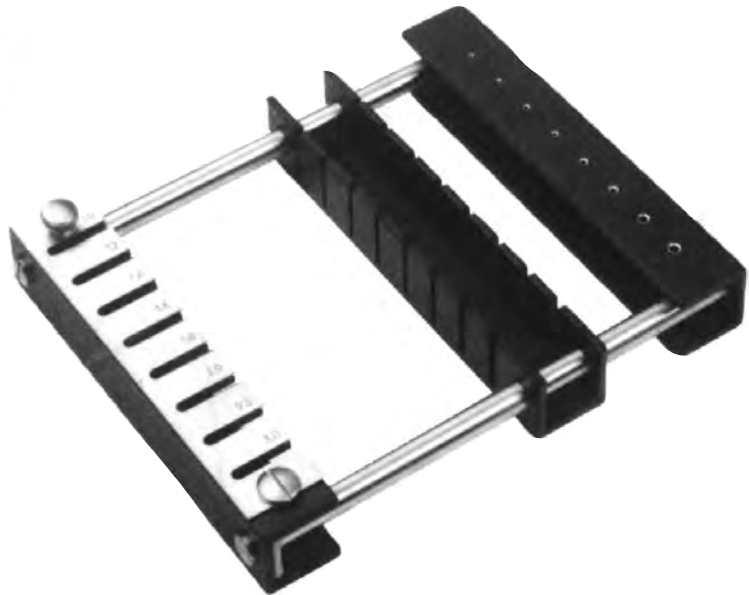

Bohrdrahtspender für Kirschner-Drähte
 Support for sterilisation of Kirschner wires
 Soporte de esterilización p. alambres de Kirschner
 Supporto per la sterilizzazione dei fili di Kirschner

34440-01 bis 15 cm – up to 15 cm (6") – hasta 15 cm – fino a 15 cm
 34440-02 bis 31 cm – up to 31 cm (12 1/4") – hasta 31 cm – fino a 31 cm
 34440-03 bis 10 cm – up to 10 cm (4") – hasta 10 cm – fino a 10 cm

Bohrdrähte
Drill Wires
Alambres
Perforatori filiformi

lieferbar in Packungen à 10 Stück
available in packages of 10 pieces
disponible en paquets de 10 unidades
disponibili solo in confezioni da 10 pezzi

Trokarspitze / Trocar point
Punta trocar / Punte trequarti



Ø	10 cm, 4"	15 cm, 6"	31 cm, 12 1/4"
0,8	34401-08	34402-08	34403-08
1,0	34401-10	34402-10	34403-10
1,1	34401-11	34402-11	34403-11
1,2	34401-12	34402-12	34403-12
1,3	34401-13	34402-13	34403-13
1,4	34401-14	34402-14	34403-14
1,5	34401-15	34402-15	34403-15
1,6	34401-16	34402-16	34403-16
1,7	34401-17	34402-17	34403-17
1,8	34401-18	34402-18	34403-18
1,9	34401-19	34402-19	34403-19
2,0	34401-20	34402-20	34403-20
2,2	34401-22	34402-22	34403-22
2,3	34401-23	34402-23	34403-23
2,4	34401-24	34402-24	34403-24
2,5	34401-25	34402-25	34403-25
2,8	34401-28	34402-28	34403-28
3,0	34401-30	34402-30	34403-30

Kirschner
mit rundem Ende / with round shaft
con extremo redondo / con extremo rotondo

Trokarspitze / Trocar point
Punta trocar / Punte trequarti



Ø	10 cm, 4"	15 cm, 6"	31 cm, 12 1/4"
0,8	34404-08	34405-08	34406-08
0,9	34404-09	34405-09	34406-09
1,0	34404-10	34405-10	34406-10
1,1	34404-11	34405-11	34406-11
1,2	34404-12	34405-12	34406-12
1,3	34404-13	34405-13	34406-13
1,4	34404-14	34405-14	34406-14
1,5	34404-15	34405-15	34406-15
1,6	34404-16	34405-16	34406-16
1,7	34404-17	34405-17	34406-17
1,8	34404-18	34405-18	34406-18
1,9	34404-19	34405-19	34406-19
2,0	34404-20	34405-20	34406-20
2,2	34404-22	34405-22	34406-22
2,3	34404-23	34405-23	34406-23
2,4	34404-24	34405-24	34406-24
2,5	34404-25	34405-25	34406-25
2,8	34404-28	34405-28	34406-28
3,0	34404-30	34405-30	34406-30

Kirschner
mit flachem Ende / with flat shaft
con extremo plano / con extremo piatto

Trokarspitze / Trocar point
Punta trocar / Punte trequarti



Ø	10 cm, 4"	15 cm, 6"	31 cm, 12 1/4"
0,8	34407-08	34408-08	34409-08
0,9	34407-09	34408-09	34409-09
1,0	34407-10	34408-10	34409-10
1,1	34407-11	34408-11	34409-11
1,2	34407-12	34408-12	34409-12
1,3	34407-13	34408-13	34409-13
1,4	34407-14	34408-14	34409-14
1,5	34407-15	34408-15	34409-15
1,6	34407-16	34408-16	34409-16
1,7	34407-17	34408-17	34409-17
1,8	34407-18	34408-18	34409-18
1,9	34407-19	34408-19	34409-19
2,0	34407-20	34408-20	34409-20
2,2	34407-22	34408-22	34409-22
2,3	34407-23	34408-23	34409-23
2,4	34407-24	34408-24	34409-24
2,5	34407-25	34408-25	34409-25
2,8	34407-28	34408-28	34409-28
3,0	34407-30	34408-30	34409-30

Kirschner
Trokarende / Trocar shaft
Punta trocar / Punte trequarti Bilaterali

Lanzenspitze / Lance point
Punta lanceolar / Punte lanceolata



Ø	31 cm, 12 1/4"
0,8	34410-08
0,9	34410-09
1,0	34410-10
1,1	34410-11
1,2	34410-12
1,3	34410-13
1,4	34410-14
1,5	34410-15
1,6	34410-16
1,7	34410-17
1,8	34410-18
1,9	34410-19
2,0	34410-20
2,2	34410-22
2,3	34410-23
2,4	34410-24
2,5	34410-25
2,8	34410-28
3,0	34410-30

Kirschner
mit flachem Ende / with flat shaft
con extremo plano / con extremo piatto

lieferbar in Packungen à 10 Stück
 available in packages of 10 pieces
 disponible en paquetetes de 10 unidades
 disponibili solo in confezioni da 10 pezzi

Bohrdrähte, Knochennägel
 Drill Wires, Fracture pins
 Alambres, Clavos para huesos
 Perforatori filiformi, Chiodi per ossa

Lanzenspitze / Lance point
 Punta lanceolar / Punta lanceolata



Ø	31 cm, 12 1/4"
0,8	34411-08
0,9	34411-09
1,0	34411-10
1,1	34411-11
1,2	34411-12
1,3	34411-13
1,4	34411-14
1,5	34411-15
1,6	34411-16
1,7	34411-17
1,8	34411-18
1,9	34411-19
2,0	34411-20
2,2	34411-22
2,3	34411-23
2,4	34411-24
2,5	34411-25
2,8	34411-28
3,0	34411-30

Trokarspitze / Trocar point
 Punta trocar / Punta trequarti



	Ø	Ø	Ø	Ø	Ø	Ø	Ø
	3,5 mm	4,0 mm	4,5 mm	4,8 mm	5,0 mm	5,5 mm	6,0 mm
8 cm, 3 1/8"	34412-08	34413-08	34415-08	34416-08	34417-08	34418-08	34419-08
10 cm, 4"	34412-10	34413-10	34415-10	34416-10	34417-10	34418-10	34419-10
12 cm, 4 3/4"	34412-12	34413-12	34415-12	34416-12	34417-12	34418-12	34419-12
14 cm, 5 1/2"	34412-14	34413-14	34415-14	34416-14	34417-14	34418-14	34419-14
16 cm, 6 1/4"	34412-16	34413-16	34415-16	34416-16	34417-16	34418-16	34419-16
18 cm, 7"	34412-18	34413-18	34415-18	34416-18	34417-18	34418-18	34419-18
20 cm, 8"	34412-20	34413-20	34415-20	34416-20	34417-20	34418-20	34419-20
22 cm, 8 3/4"	34412-22	34413-22	34415-22	34416-22	34417-22	34418-22	34419-22
23 cm, 9"	34412-23	34413-23	34415-23	34416-23	34417-23	34418-23	34419-23
24 cm, 9 1/2"	34412-24	34413-24	34415-24	34416-24	34417-24	34418-24	34419-24
26 cm, 10 1/4"	34412-26	34413-26	34415-26	34416-26	34417-26	34418-26	34419-26
28 cm, 11"	34412-28	34413-28	34415-28	34416-28	34417-28	34418-28	34419-28
30 cm, 11 3/4"	34412-30	34413-30	34415-30	34416-30	34417-30	34418-30	34419-30

Kirschner
 mit rundem Ende / with round shaft
 con extremo redondo / con extremo rotondo

Steinmann
 mit rundem Ende / with round shaft
 con extremo redondo / con extremo rotondo

Trokarspitze / Trocar point
 Punta trocar / Punta trequarti



	Ø	Ø	Ø	Ø	Ø	Ø	Ø	Ø
	3,5 mm	4,0 mm	4,2 mm	4,5 mm	4,8 mm	5,0 mm	5,5 mm	6,0 mm
8 cm, 3 1/8"	34420-08	34421-08	34422-08	34423-08	34424-08	34425-08	34426-08	34427-08
10 cm, 4"	34420-10	34421-10	34422-10	34423-10	34424-10	34425-10	34426-10	34427-10
12 cm, 4 3/4"	34420-12	34421-12	34422-12	34423-12	34424-12	34425-12	34426-12	34427-12
14 cm, 5 1/2"	34420-14	34421-14	34422-14	34423-14	34424-14	34425-14	34426-14	34427-14
16 cm, 6 1/4"	34420-16	34421-16	34422-16	34423-16	34424-16	34425-16	34426-16	34427-16
18 cm, 7"	34420-18	34421-18	34422-18	34423-18	34424-18	34425-18	34426-18	34427-18
20 cm, 8"	34420-20	34421-20	34422-20	34423-20	34424-20	34425-20	34426-20	34427-20
22 cm, 8 3/4"	34420-22	34421-22	34422-22	34423-22	34424-22	34425-22	34426-22	34427-22
23 cm, 9"	34420-23	34421-23	34422-23	34423-23	34424-23	34425-23	34426-23	34427-23
24 cm, 9 1/2"	34420-24	34421-24	34422-24	34423-24	34424-24	34425-24	34426-24	34427-24
26 cm, 10 1/4"	34420-26	34421-26	34422-26	34423-26	34424-26	34425-26	34426-26	34427-26
28 cm, 11"	34420-28	34421-28	34422-28	34423-28	34424-28	34425-28	34426-28	34427-28
30 cm, 11 3/4"	34420-30	34421-30	34422-30	34423-30	34424-30	34425-30	34426-30	34427-30

Steinmann
 Trokarende / Trocar shaft
 Punta trocar / Punta trequarti Bilateralis

Knochennägel
Fracture pins
Clavos para huesos
Chiodi per ossa

lieferbar in Packungen à 10 Stück
available in packages of 10 pieces
disponible en paquets de 10 unidades
disponibili solo in confezioni da 10 pezzi

Trokarspitze / Trocar point
Punta trocar / Punta trequarti

	Ø	Ø	Ø	Ø	Ø	Ø	Ø	Ø
	3,5 mm	4,0 mm	4,2 mm	4,5 mm	4,8 mm	5,0 mm	5,5 mm	6,0 mm
8 cm, 3 1/8"	34428-08	34429-08	34430-08	34431-08	34432-08	34433-08	34434-08	34435-08
10 cm, 4"	34428-10	34429-10	34430-10	34431-10	34432-10	34433-10	34434-10	34435-10
12 cm, 4 3/4"	34428-12	34429-12	34430-12	34431-12	34432-12	34433-12	34434-12	34435-12
14 cm, 5 1/2"	34428-14	34429-14	34430-14	34431-14	34432-14	34433-14	34434-14	34435-14
16 cm, 6 1/4"	34428-16	34429-16	34430-16	34431-16	34432-16	34433-16	34434-16	34435-16
18 cm, 7"	34428-18	34429-18	34430-18	34431-18	34432-18	34433-18	34434-18	34435-18
20 cm, 8"	34428-20	34429-20	34430-20	34431-20	34432-20	34433-20	34434-20	34435-20
22 cm, 8 3/4"	34428-22	34429-22	34430-22	34431-22	34432-22	34433-22	34434-22	34435-22
23 cm, 9"	34428-23	34429-23	34430-23	34431-23	34432-23	34433-23	34434-23	34435-23
24 cm, 9 1/2"	34428-24	34429-24	34430-24	34431-24	34432-24	34433-24	34434-24	34435-24
26 cm, 10 1/4"	34428-26	34429-26	34430-26	34431-26	34432-26	34433-26	34434-26	34435-26
28 cm, 11"	34428-28	34429-28	34430-28	34431-28	34432-28	34433-28	34434-28	34435-28
30 cm, 11 3/4"	34428-30	34429-30	34430-30	34431-30	34432-30	34433-30	34434-30	34435-30

Steinmann
mit 3-kant-Ende / with triangular end
con extremo triangular / con estremo triangolare

Trokarspitze / Trocar point
Punta trocar / Punta trequarti

mit Gewinde threaded Wires con rosca con filetto	Ø	15 cm, 6"	18 cm, 7"	20 cm, 8"	23 cm, 9"	25 cm, 10"	31 cm, 12 1/4"
	1,2	34436-12	34437-12	34438-12	34439-12	34440-12	34441-12
	1,4	34436-14	34437-14	34438-14	34439-14	34440-14	34441-14
	1,6	34436-16	34437-16	34438-16	34439-16	34440-16	34441-16
	1,8	34436-18	34437-18	34438-18	34439-18	34440-18	34441-18
	2,0	34436-20	34437-20	34438-20	34439-20	34440-20	34441-20
	2,4	34436-24	34437-24	34438-24	34439-24	34440-24	34441-24
	2,5	34436-25	34437-25	34438-25	34439-25	34440-25	34441-25
	2,8	34436-28	34437-28	34438-28	34439-28	34440-28	34441-28
	3,0	34436-30	34437-30	34438-30	34439-30	34440-30	34441-30
	3,2	34436-32	34437-32	34438-32	34439-32	34440-32	34441-32
	3,5	34436-35	34437-35	34438-35	34439-35	34440-35	34441-35

mit rundem Ende / with round shaft
con extremo redondo / con estremo rotondo

lieferbar in Packungen à 10 Stück
 available in packages of 10 pieces
 disponible en paquets de 10 unidades
 disponibili solo in confezioni da 10 pezzi

Knochennägel
 Fracture pins
 Clavos para huesos
 Chiodi per ossa

Trokarspitze / Trocar point
 Punta trocar / Punta trequarti

mit Gewinde
 threaded Wires
 con rosca
 con filetto



Ø	15 cm, 6"	18 cm, 7"	20 cm, 8"	23 cm, 9"	25 cm, 10"	31 cm, 12 1/4"
1,2	34442-12	34443-12	34444-12	34445-12	34446-12	34447-12
1,4	34442-14	34443-14	34444-14	34445-14	34446-14	34447-14
1,6	34442-16	34443-16	34444-16	34445-16	34446-16	34447-16
1,8	34442-18	34443-18	34444-18	34445-18	34446-18	34447-18
2,0	34442-20	34443-20	34444-20	34445-20	34446-20	34447-20
2,4	34442-24	34443-24	34444-24	34445-24	34446-24	34447-24
2,5	34442-25	34443-25	34444-25	34445-25	34446-25	34447-25
2,8	34442-28	34443-28	34444-28	34445-28	34446-28	34447-28
3,0	34442-30	34443-30	34444-30	34445-30	34446-30	34447-30
3,2	34442-32	34443-32	34444-32	34445-32	34446-32	34447-32
3,5	34442-35	34443-35	34444-35	34445-35	34446-35	34447-35

Trokarende / Trocar shaft
 Punta trocar / Punta trequarti

Bohrdrahtspender
 K-Wire Dispenser
 Dispensador para brocas filiformes
 Distributore per fili

12 cm, 4 3/4"



17 cm, 6 3/4"



33 cm, 13"



34450-08 0,8 mm
 34450-10 1,0 mm
 34450-12 1,2 mm
 34450-14 1,4 mm
 34450-15 1,5 mm
 34450-18 1,8 mm
 34450-20 2,0 mm
 34450-22 2,2 mm
 34450-25 2,5 mm
 34450-30 3,0 mm

34460-08 0,8 mm
 34460-10 1,0 mm
 34460-12 1,2 mm
 34460-14 1,4 mm
 34460-15 1,5 mm
 34460-16 1,6 mm
 34460-20 2,0 mm
 34460-22 2,2 mm
 34460-25 2,5 mm
 34460-30 3,0 mm

34470-08 0,8 mm
 34470-10 1,0 mm
 34470-12 1,2 mm
 34470-14 1,4 mm
 34470-15 1,5 mm
 34470-16 1,6 mm
 34470-20 2,0 mm
 34470-22 2,2 mm
 34470-25 2,5 mm
 34470-30 3,0 mm

Fingerschützer, Drahtgeflecht
Finger Protectors, Wire gauze
Dedales, Gasa metálica
Proteggidita, maglia metallica per estensione



34480-01



34480-02



34480-03

LANGENBECK
34480-01 - 34480-03



34492-01
klein / small / pequeño / stretto

34492-02
mittel / medium / mediano / medio

34492-03
groß / large / grande / grande

34492-01 - 34492-03

sterilisierbar
sterilizable
esterilizabile
sterilizzabile

Extensionsbügel
 Extension Bows
 Estribos para extensión
 Archi per estensione

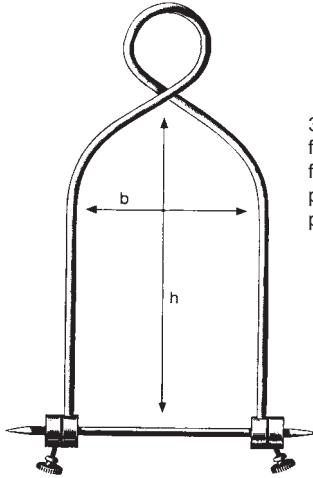

34502-16
 für Arm
 for arm
 para brazo
 per braccio

16 x 9 cm
 6 1/4" x 3 1/2"

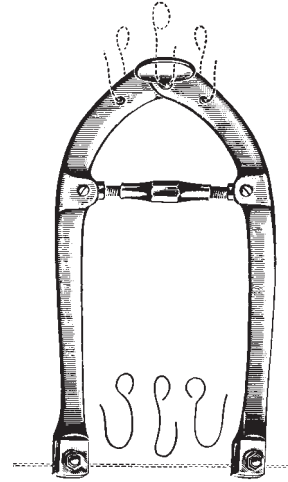

KIRSCHNER

BÖHLER

34502-15 21 x 15 cm 8 1/4" x 6"
 34502-21 21 x 11 cm 8 1/4" x 4 3/8"
 für Oberschenkel und Knie
 for thigh and knee
 para femur y rodilla
 per femore e ginocchio

34514-18 40 - 140 mm x 115 mm mit 3 Zughaken
 with 3 hooks
 con 3 ganchos
 con 3 ganci per trazione
 34514-27 60 - 220 mm x 175 mm mit 3 Zughaken
 with 3 hooks
 con 3 ganchos
 con 3 ganci per trazione

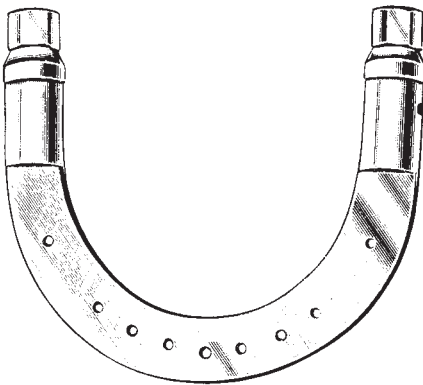

KIRSCHNER

34515-09 9,5 x 7,0 cm 3 3/4" x 2 3/4"
 34515-10 9,5 x 11,0 cm 3 3/4" x 4 3/8"
 34515-11 10,5 x 10,0 cm 4.1" x 4"
 34515-12 12,0 x 12,0 cm 4 3/4" x 4 3/4"
 34515-13 13,5 x 13,0 cm 5 1/4" x 5 1/8"
 34515-15 15,5 x 15,5 cm 6" x 6"
 34515-20 20,0 x 15,5 cm 8" x 6"

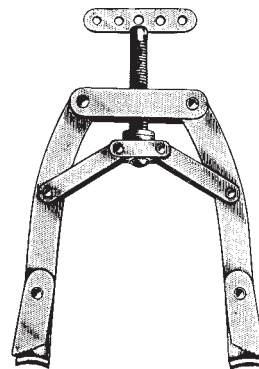

KIRSCHNER U.S.

34518-01
 mittel, medium, mediano, max. 130 mm (5 1/8")
 34518-02
 groß, large, grande, grande, max. 185 mm (7 1/4")
 34518-03
 extra groß, large extra long, muy grande, max. 220 mm (8 3/4")

Mutterschlüssel, Spanschlüssel
Screw nut wrench, Wire strainer
llave de tuercas, Tensor de taladros, alambres
Chiave per madreviti, Strumenti tenditore



34515-01

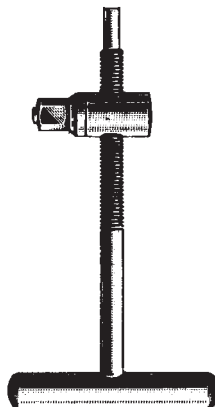

34515-02

Zughaken
hooks
ganchos
ganci per trazione

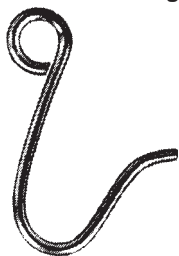
KIRSCHNER
34519-01KIRSCHNER
34519-02

Knochendraht
Bone wire
Hilos para huesos
Filo per ossa



weich, in Ringen zu 10 m (32,8 Feet)
soft, in coils of 10 m (32,8 Feet)
blando, de 10 m (32,8 Feet)
morbido, 10 m (32,8 Feet)

Material:
nichtrostender Implantatstahl
nach DIN 17443 (ISO 5832/1)

	mm Ø
34520-02	0,2
34520-03	0,3
34520-04	0,4
34520-05	0,5
34520-06	0,6
34520-07	0,7
34520-08	0,8
34520-09	0,9
34520-10	1,0
34520-12	1,2
34520-15	1,5

Drahtumföhrungsnadeln, Drahtspanninstrumente
 Bone wire guides, Bone wire tighteners
 Agujas pasa-hilos, Tensor cierra-hilos
 Aghi passafili, Strumenti tendifili



DEMEL

27 cm, 10 1/2"

Fig. 1 34528-01

Fig. 2 34528-02

Fig. 3 34528-03

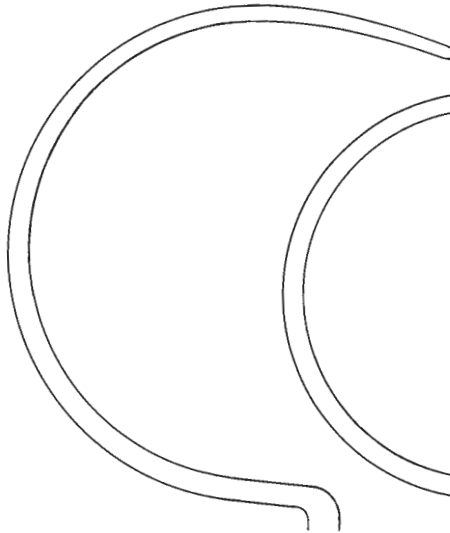

Fig. 1

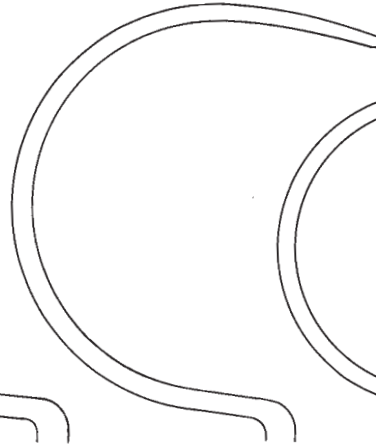

Fig. 2

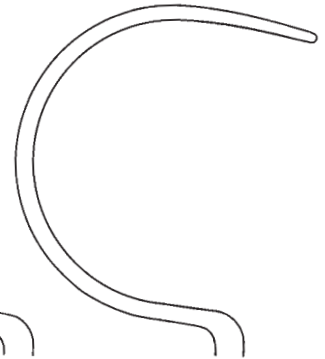
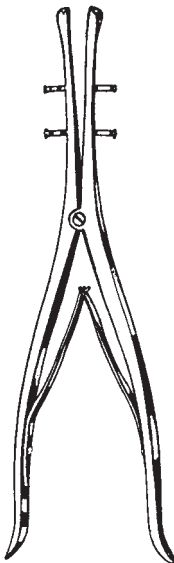
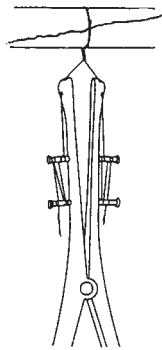

Fig. 3



DEMEL

34530-28 28 cm, 11"



LOUTE

34531-21 21 cm, 8 1/4"

Flachzangen, Faßzangen
 Flat Nose Pliers, Seizing Forceps
 Alicates planos, Pinzas para coger alambres
 Tenaglie piatte, Tenaglie per afferrare



17 cm, 6 3/4"
 34533-17 INOX



GRIP
 18 cm, 7"
 34534-18 INOX



34534-15
 15 cm, 6"



34535-16
 16 cm, 6 1/4"

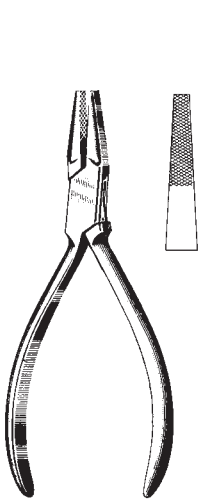

34536-14
 14 cm, 5 1/2"



34537-19
 19 cm, 7 1/2"

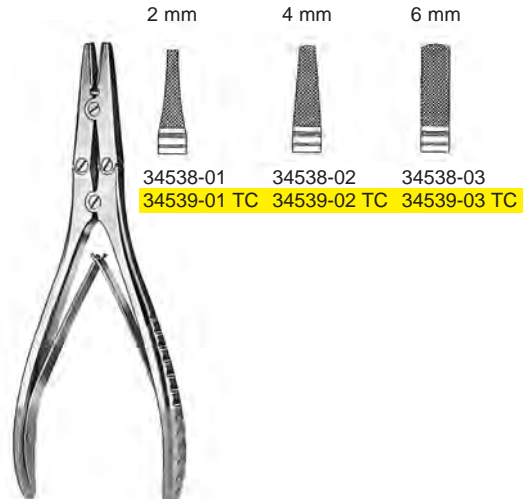

2 mm 4 mm 6 mm
 34538-01 34538-02 34538-03
 34539-01 TC 34539-02 TC 34539-03 TC

18 cm, 7"

Flachzangen, Drahtkneifzangen
 Flat Nose Pliers, Wire cutting Pliers
 Alicates planos, Alicates para cortar alambres
 Tenaglie piate, Tenaglie tagliafili



34540-01



34540-02



17 cm, 6 3/4"

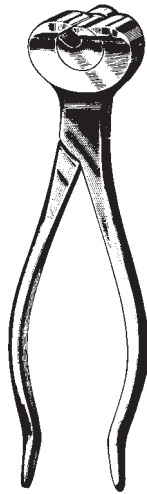

34540-16
 16 cm, 6 1/4"

soft wire 2,0 mm
 hard wire 2,0 mm



34540-18
 18 cm, 7"



34541-23 23 cm, 9"

soft wire 3,0 mm
 hard wire 2,2 mm

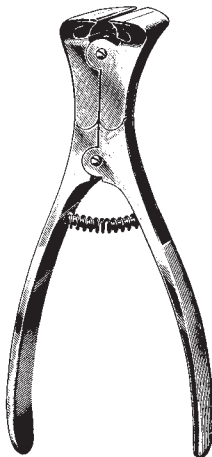

34542-15 TC 15 cm, 6"

Soft wire 2,0 mm
 hard wire 1,5 mm



34543-23 23 cm, 9"

Soft wire 3,5 mm
 hard wire 2,5 mm



34544-18 TC 18 cm, 7"

Soft wire 2,5 mm
 hard wire 1,5 mm

Drahtkneifzangen, Drahtfaßzangen
 Wire Cutting Pliers, Wire Seizing Forceps
 Alicates para cortar alambres, Pinzas para coger alambres
 Tronchese taglienti, Tenaglie per afferrare i fili



für harten Draht bis
 2,2 mm Ø
 for hard wires up to
 2,2 mm Ø
 para hilos duros
 hasta 2,2 mm Ø
 per fili duri a
 2,2 mm Ø

für weichen Draht bis
 2,5 mm Ø
 for soft wires up to
 2,5 mm Ø
 para hilos blandos
 hasta 2,5 mm Ø
 per fili dolci fino a
 2,5 mm Ø

34545-22 TC 22 cm, 10 1/2"

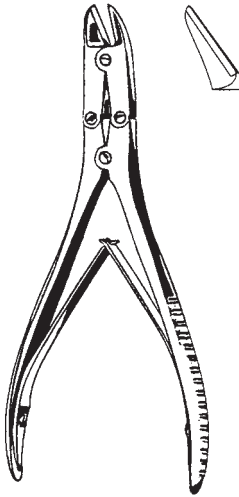

für harten Draht bis 1,6 mm Ø
 for hard wires up to 1,6 mm Ø
 para hilos duros hasta 1,6 mm Ø
 per fili duri a 1,6 mm Ø

für weichen Draht bis 2,0 mm Ø
 for soft wires up to 2,0 mm Ø
 para hilos blandos hasta 2,0 mm Ø
 per fili dolci fino a 2,0 mm Ø

34546-16 16 cm, 6 1/4"
 34546-18 18 cm, 7"



für weichen Draht bis
 2,0 mm Ø
 for soft wires up to
 2,0 mm Ø
 para hilos blandos
 hasta 2,0 mm Ø
 per fili dolci fino a
 2,0 mm Ø

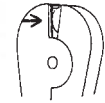

für harten Draht bis
 1,6 mm Ø
 for hard wires up to
 1,6 mm Ø
 para hilos duros
 hasta 1,6 mm Ø
 per fili duri a
 1,6 mm Ø

34548-18 18 cm, 7"



soft wire 1,5 mm
 hard wire 1,0 mm

34549-14 14 cm, 5 1/2"



34550-13 13 cm, 5 1/8"
 34550-18 18 cm, 7"

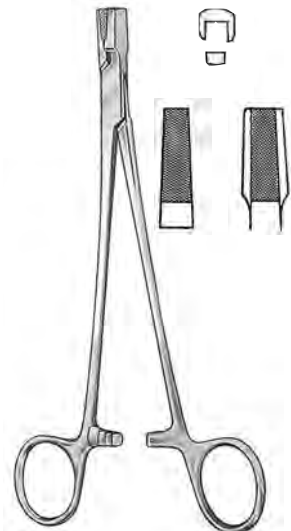

17 cm, 6 3/4"
 34551-17 TC

Drahtzangen
Wire Twisting Forceps
Pinzas para torcer hilos
Pinza torcifili



CORWIN-HEGAR
34552-16 TC 16 cm, 6 1/4"



BERRY
34556-18 TC 18 cm, 7"



MAYO-HABERISSER
TC

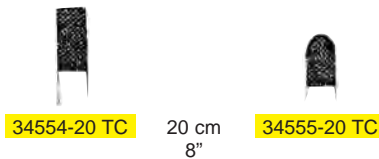
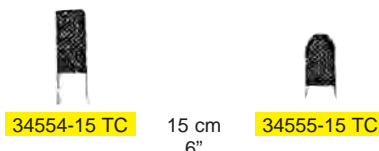

Drahtkneifzange für Draht bis 6 mm Ø
 Pin cutter for pins up to 6 mm
 Alicates para cortar clavos hasta 6 mm
 Ghigliottina per tagliare fili fino a 6 mm



34558-32 32 cm, 12 1/2"

bis 2.2 mm
 up to 2.2 mm
 hasta 2.2 mm
 a 2.2 mm



34559-47 47 cm, 18 1/2"

bis 6 mm
 up to 6 mm
 hasta 6 mm
 a 6 mm



34560-57 57 cm 22 1/2"

bis 6.5 mm
 up to 6.5 mm
 hasta 6.5 mm
 a 6.5 mm

Instrumentarium für Ender und Küntscher Nägel
 Instruments for ender and Küntscher Nails
 Instrumental para Clavos Ender y Küntscher
 Strumentario per chiodi di Ender e Küntscher

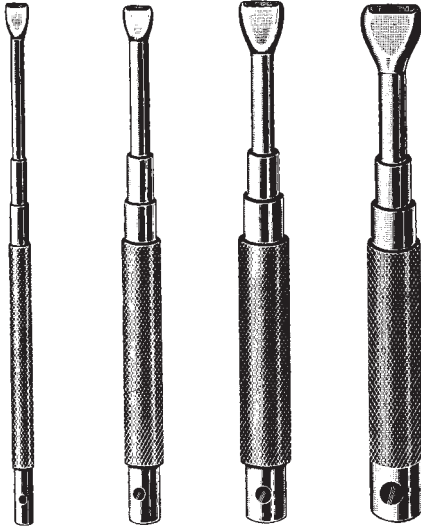

34562-24	34562-32	34562-48	34562-64
f./p. Ø 2,4 mm	3,2 mm	4,8 mm	6,4 mm

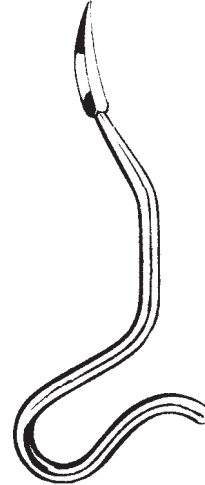

KÜNTSCHER	26 cm, 10 1/4"
34570-01	8 mm
34570-02	10 mm

Ein- und Ausschlaginstrumente für Ender-Nägel
 Driver-extractors for Ender nails
 Impactores-Extractores para clavos de Ender
 Impattatore-Estrattore per chiodi di Ender

Vorböhrer zum Öffnen der Markhöhle
 Reamers for medullary cave
 Perforadores para la cavidad medular
 Alesatore per l'apertura del midollo



KÜNTSCHER
 34573-35 35 cm, 13 3/4"
 Aufreiber für Oberschenkel
 Reamer for femur
 Perforador para fémur
 Alesatore per femore



Führungsspieße
 Guide pins
 Guía-conductora para clavos medulares
 Guida conduttrice

mm Ø	L = 60 cm, 23 3/4"
3,5	34583-60
4,0	34584-60
5,0	34585-60



für Nägel for nails para clavos per chiodi	
Ø 6-8 mm	34588-01
Ø 9-12 mm	34588-02
Ø 12-17 mm	34588-03
KUENTSCHER	19 cm, 7 1/2"
Fertigschläger Nail impactors Impactor final Impattatore finale	

Instrumentarium für Küntscher Nägel
 Instruments for Küntscher Nails
 Instrumental para Clavos Küntscher
 Strumentario per chiodi di Küntscher

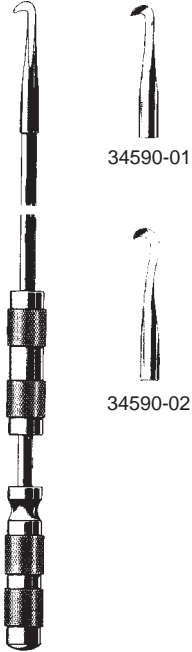

KÜNTSCHER 63 cm, 24 3/4"
 34590-00 komplett mit 2 Haken 34590-01/02
 34590-00 complete with 2 hooks 34590-01/02
 34590-00 completo con 2 ganchos 34590-01/02
 34590-00 completo con 2 ganci 34590-01/02

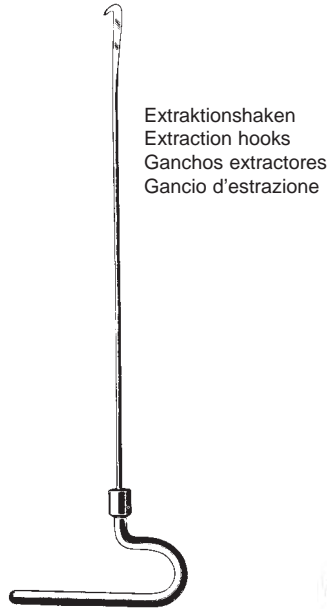

Extraktionshaken
 Extraction hooks
 Ganchos extractores
 Gancio d'estrazione

cm
 29, 11.4"
 37, 14.5"
 42, 16.5"
 49, 19.3"

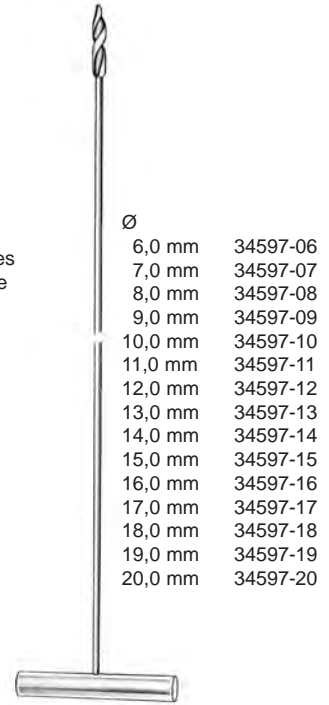

Ø
 6,0 mm 34597-06
 7,0 mm 34597-07
 8,0 mm 34597-08
 9,0 mm 34597-09
 10,0 mm 34597-10
 11,0 mm 34597-11
 12,0 mm 34597-12
 13,0 mm 34597-13
 14,0 mm 34597-14
 15,0 mm 34597-15
 16,0 mm 34597-16
 17,0 mm 34597-17
 18,0 mm 34597-18
 19,0 mm 34597-19
 20,0 mm 34597-20

Markraumborher
 Intramedullary drills
 Perforadores medulares
 Perforatore intramidollare

Extraktor / Nail extractor
 Aparato extractor / Estrattore



Einschläger / Nail Inserter
 Introducor clavos / Impattore
 34612-00



Impactor
 34613-00



Bender
 34615-00

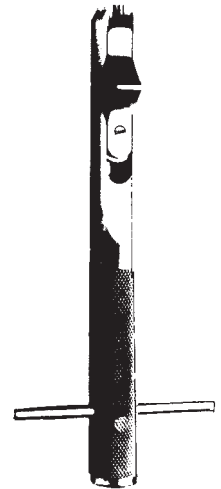

Impactor-Extractor
 Impattore-Estrattore
 34617-00

Schraubenzieher
Screw Drivers
Destornilladores
Cacciaviti



LANE
34620-25 25 cm, 10"
Schraubenzieher 6 mm
Screw Driver 6 mm
Destornillador 6 mm
Cacciaviti 6 mm



WILLIAMS
24 cm
9 1/2"

3,5 mm



34624-01



34624-02



34624-03



34624-04



mit Ferrozellgriff
with Ferrozell handle
con mango de Ferrozell
con manico di Ferrozell



34628-01
25 cm
10"



34628-02
25 cm
10"



34629-01
25 cm
10"



1,5 mm
34628-15
20 cm
8"



2,5 mm
34628-25
25 cm
10"



3,5 mm
34628-35
25 cm
10"

Schraubenzieher
Screw Drivers
Destornilladores
Cacciaviti



LANE
34632-25 25 cm, 10"
Kreuzschlitzschraubenzieher
Screwdriver for cross slotted head
Destornillador para tornillos con ranura en cruz
Cacciavite a croce



Schraubenhaltehülse für Sechskantschrauben
Screw holder
Vaina para tornillos
Guaina per viti esagonali
34634-25 2,5 mm
34634-35 3,5 mm

Haltezangen, Biegehebel
 Holding Forceps, Bender
 Pinzas para sostener placas y tornillos, Palanca
 Pinza portaplacca, leva piegaplacche

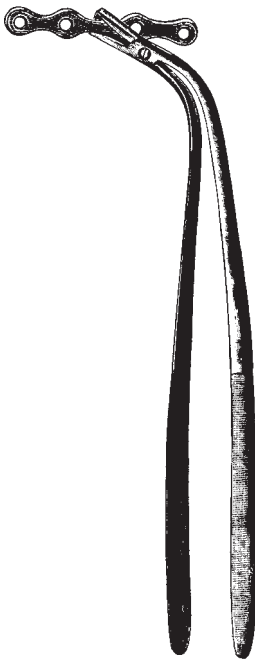

LANE
 34637-23 23 cm, 9"

Knochenplatten-Haltezange
 Plate Holding Forceps
 Pinza para sostener placas
 Pinza portaplacche



LANE
 34639-22 22 cm, 8 3/4"

Schraubenhalte-zange
 Screw Holding Forceps
 Pinza para sostener tornillos
 Pinza portaviti

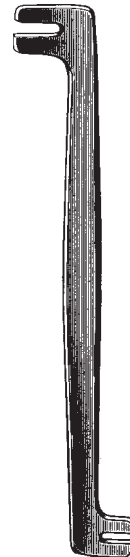

LANE
 34640-18 18 cm, 7"

Biegehebel f. Knochenplatten
 Plate Bender
 Palanca para doblar placas
 Leva piegaplacche

Anlegezangen, Silberklammern
 Applying Fcps. Clips
 Pinzas aplicadoras, Grapas
 Pinza per applicare, Agrafes

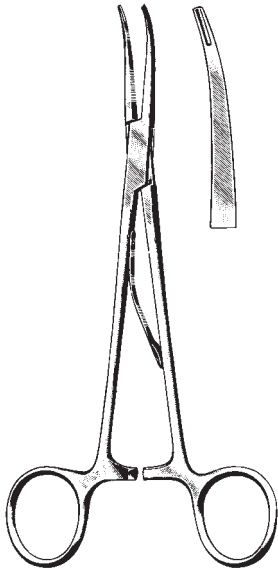

McKENZIE

41011-15 15 cm, 6"
 41011-19 19 cm, 7 1/2"

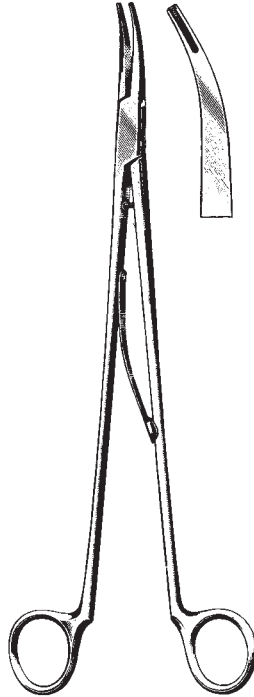

SMITHWICK

41015-23 23 cm, 9"
 41015-26 26 cm, 10 1/4"

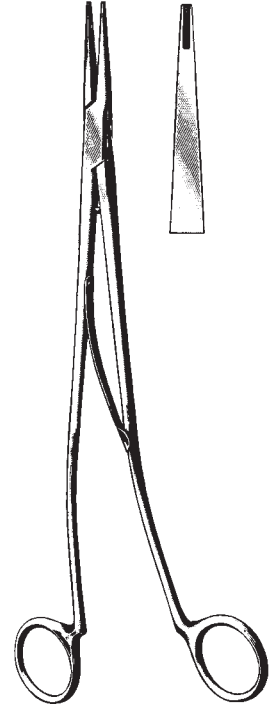

SWEET

41017-23 23 cm, 9"
 41017-26 26 cm, 10 1/4"



OLIVECRONA-TOENNIS
 41019-14

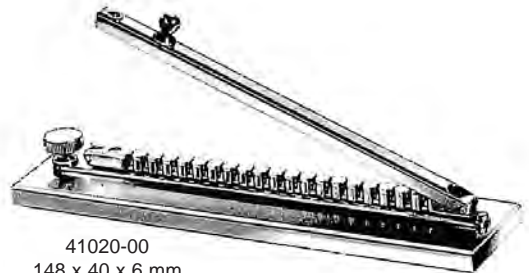

41020-00
 148 x 40 x 6 mm

Schädelhalter, Kopfhautklammer, Anlegezange
 Cervical Traction Tongs, Clips, Applying Forceps
 Pinzas de tracción craneal, Clips, Pinza para aplicar clips
 Pinze per trazione craniale, Pinza per applicare

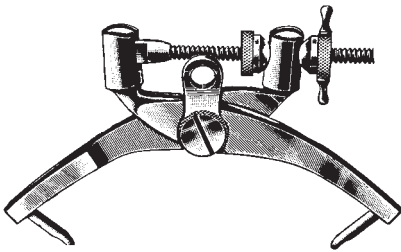

CRUTCHFIELD
41025-01



CRUTCHFIELD
41025-02



41026-35
3,5 mm Ø



41026-50
5 mm Ø

Stainless steel
Acciaio inox



RANEY
41027-00

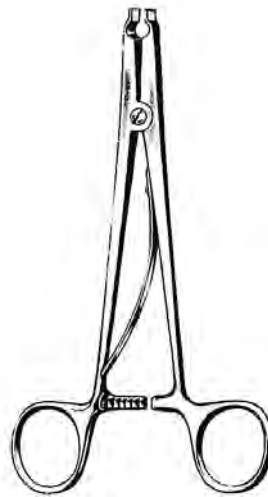

RANEY
41028-00 16 cm, 6 1/4"

Nervhaken, Durahaken
 Nerve Hooks, Dura Hooks
 Ganchos para nervios y para dura-madre
 Uncini per nervi e per dura-madre



DANDY
 41051-20
 20 cm, 8"



DANDY
 41052-20
 20 cm, 8"



DANDY
 41053-20
 20 cm, 8"



CRILE
 41054-20
 20 cm, 8"

Fig. 1



CUSHING
 41056-18
 18 cm, 7"

Fig. 2



CUSHING
 41058-18
 18 cm, 7"

Nervhaken, Durahaken
Nerve Hooks, Dura Hooks
Ganchos para nervios y para dura-madre
Unicini per nervi e per dura-madre



GRAHAM
41061-16
16,5 cm, 6 1/2"



SACHS
41064-16
18,5 cm, 7 1/4"



ADSON
41068-20
20 cm, 8"



ADSON
41069-20
20 cm, 8"



SMITHWICK
41070-29
29 cm, 11.4"

Nervwurzelnhaken
 Nerve Root Retractors
 Separadores de raiz de nervios
 Uncini per le radici dei nervi

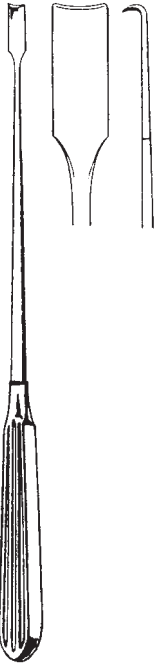

SCOVILLE
 41074-23
 23 cm, 9"



HOLSHER
 41075-24
 24 cm, 9 1/2"

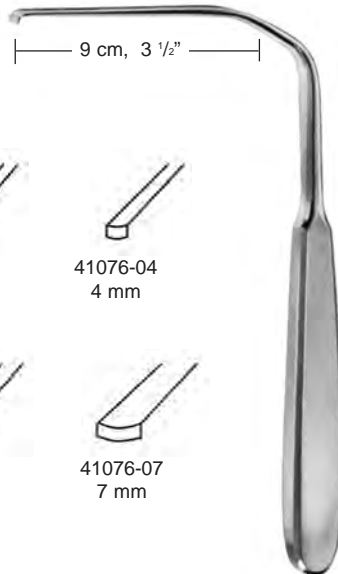

HESS
 17,5 cm, 7"



41076-03
 3 mm

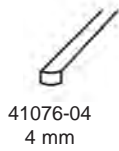

41076-04
 4 mm



41076-05
 5 mm



41076-07
 7 mm

Nervwurzelnhaken
Nerve Root Retractors
Separadores de raiz de nervios
Uncini per le radici dei nervi

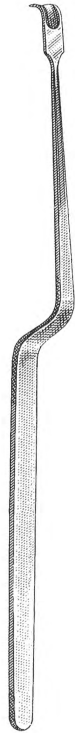

D'ERRICO
41078-23
23 cm, 9"



LOVE
41079-21
21 cm, 8 1/4"

Nervwurzelhaken, Galea Haken
 Nerve Root Retractors, Galea Hooks
 Separadores de raiz de nervios, Gancho para galea
 Uncini per le radici dei nervi, Uncini galea

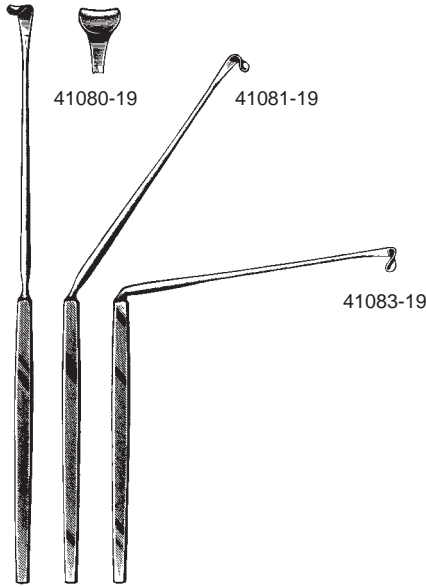

LOVE
 41080-19 – 41083-19
 19 cm, 7 1/2"

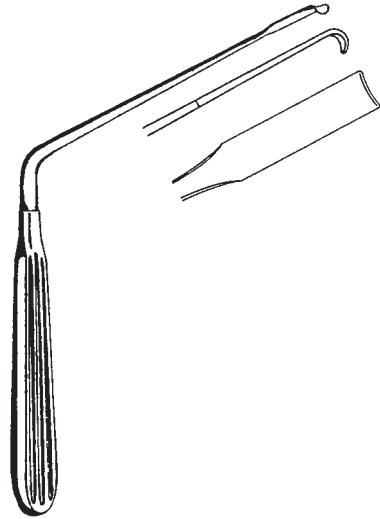

SCOVILLE
 41085-20
 20 cm, 8"



DeMARTEL
 41090-33
 33 cm, 13"



YASARGIL
 41091-31
 31 cm, 12 1/4"

Galeahaken
 Galea Hooks
 Gancho p/galea
 Gancio p/galea

Ø 7 mm

4 mm



YASARGIL
 41091-41
 41 cm, 16"

Ø 9 mm

6 mm

Schädelstanze
Cranial Punch
Pinzas sacabocado craneal
Pinza per craniotomia



CONE
41097-22
22,5 cm 9"

Dura Dissektoren, Schädelzange
 Dura Dissectors, Skull Punches
 Elevadores para la duramadre, Pinzas sacabocado craneal
 Scollatori per duramadre, Pinza per craniotomia

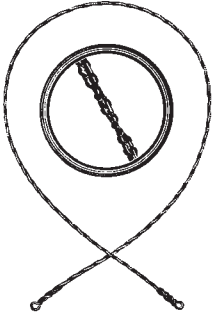

OLIVECRONA cm
 41092-30 30, 11 3/4"
 41092-40 40, 15 3/4"
 41092-50 50, 19 3/4"
 41092-60 60, 23 3/4"
 41092-70 70, 27 1/2"

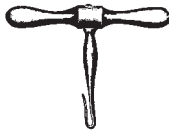

GIGLI
 41094-00



DeVILBISS
 41096-21
 21 cm, 8 1/4"



TOENNIS
 41141-25
 25 cm, 10"



SACHS
 41143-21
 21 cm, 8 1/4"

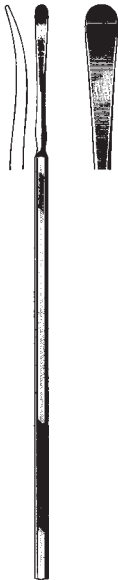

SACHS
 41145-21
 21 cm, 8 1/4"

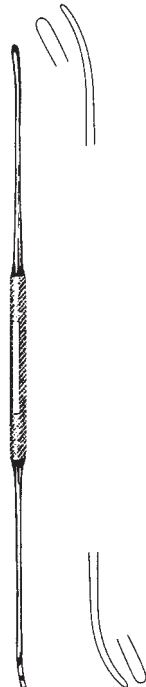

OLIVECRONA
 41146-18 18 cm, 7"
 41146-24 24 cm, 9 1/2"

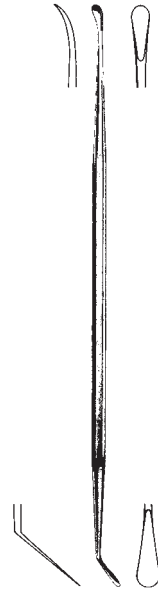

MILLIGAN
 41147-21
 21 cm, 8 1/4"



41149-22
 22 cm, 8 3/4"

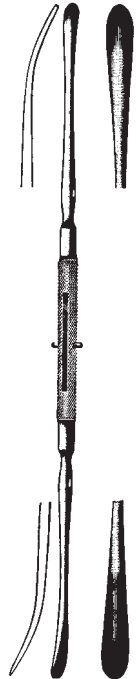

DAVIS
 41151-24
 24 cm, 9 1/2"

Dura Dissektoren
 Dura Dissectors
 Elevadores
 Scollatori

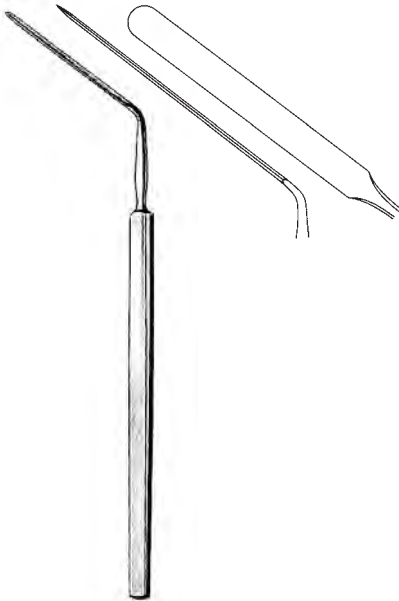

HORSLEY
 41155-20
 20 cm, 8"



WOODSON
 41156-18
 18 cm, 7"



FRAZIER
 41158-01
 15 cm, 6"



HOEN
 41158-02
 15 cm, 6"

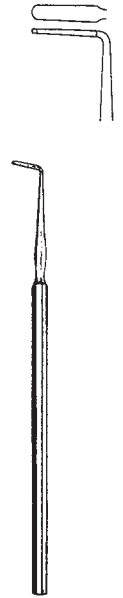

HOEN
 41158-03
 15 cm, 6"



PENFIELD
 41161-01
 17,5 cm, 6.9"



PENFIELD
 41161-02
 19,5 cm, 7 3/4"



PENFIELD
 41161-03
 19,5 cm, 7 3/4"



PENFIELD
 41161-04
 21,5 cm, 8 1/2"



PENFIELD
 41161-05
 29 cm 11.4"

Hypophyse Pinzetten, Küretten
 Hypophyseal Forceps, Curette
 Pinzas para hipófisis, Curetas
 Pinze per ipofisi, Curette



ADSON
 41210-23
 23 cm, 9"



ADSON
 41211-23
 23 cm, 9"



ADSON
 41213-23
 23 cm, 9"



41221-00
 19 cm, 7 1/2"



41222-00
 19 cm, 7 1/2"



41223-00
 19 cm, 7 1/2"



41224-00
 19 cm, 7 1/2"

Messer, Haken, Sonden
 Knives, Hooks, Probes
 Bisturies, Ganchos, Sondas
 Bisturi, Uncino, Sonde

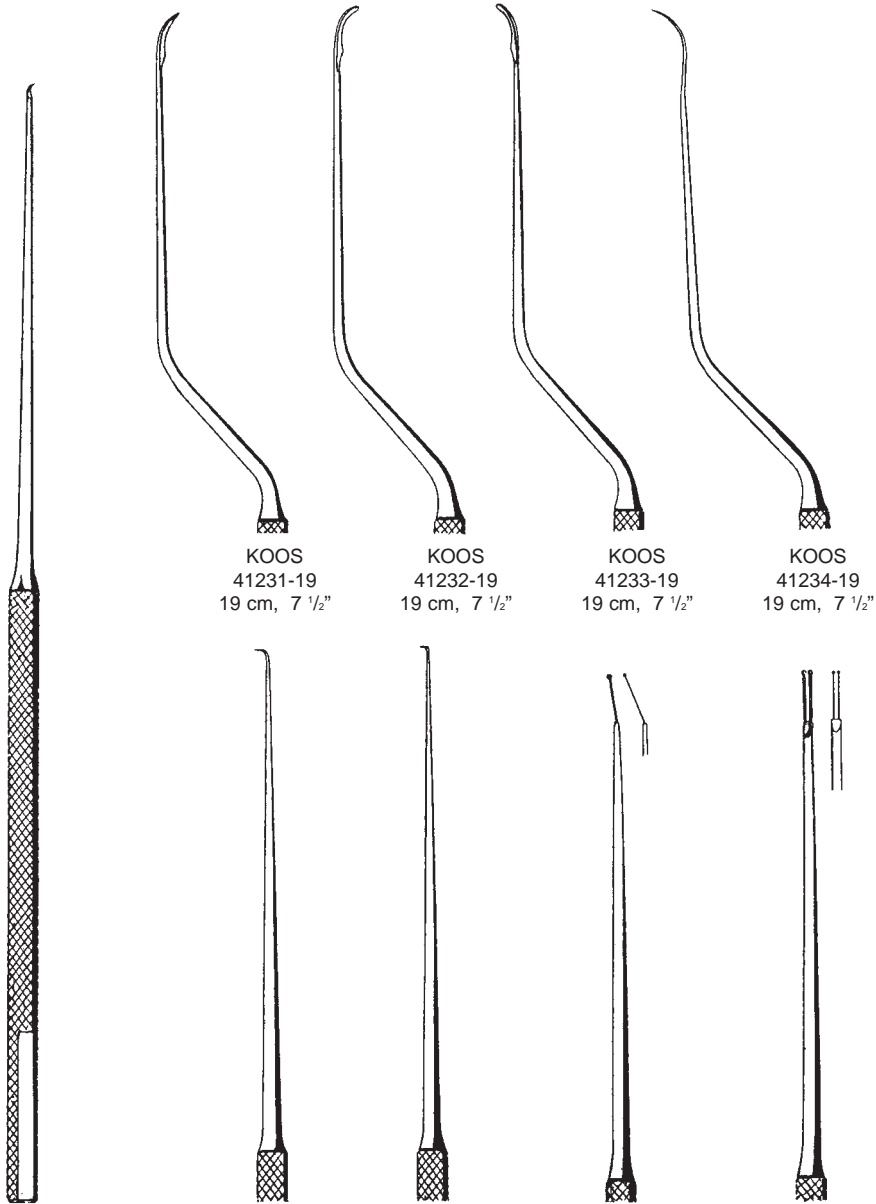

KOOS
 41231-19
 19 cm, 7 1/2"

KOOS
 41232-19
 19 cm, 7 1/2"

KOOS
 41233-19
 19 cm, 7 1/2"

KOOS
 41234-19
 19 cm, 7 1/2"

JACOBSON
 41230-19
 19 cm, 7 1/2"

41236-19
 19 cm, 7 1/2"

FISCH
 41237-19
 19 cm, 7 1/2"

JACOBSON
 41238-19
 19 cm, 7 1/2"

JACOBSON
 41239-19cm
 19 cm, 7 1/2"

Durahaken
 Dura Hook
 Ganchito para dura-madre
 Uncino dura madre

Feines Hákchen
 Delicate Hook
 Ganchito muy fino
 Uncino molto fino

Knopfsonde
 Buttoned Probe
 Sonda abotonada
 Sonda bottonuta

Doppelsonde
 Twin Probe
 Sonda doble
 Sonda doppia

Nervhäkchen, Hirnspatel, Saugrohre
 Nerve Hooks, Brain Spatulas, Suction Tubes
 Ganchos para nervios, Espatulas cerebrales, Tubos de aspiración
 Uncini per nervi, Spatole cerebrali, Tubi aspirazioni



KRAYENBÜHL
 41242-19
 19 cm, 7 1/2"



KRAYENBÜHL
 41243-19
 19 cm, 7 1/2"



KRAYENBÜHL
 41244-19
 19 cm, 7 1/2"



KRAYENBÜHL
 41245-19
 19 cm, 7 1/2"

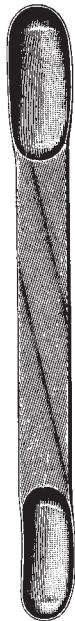

CUSHING
 41250-11 8x10 mm
 41250-15 13x15 mm
 41250-18 16x18 mm

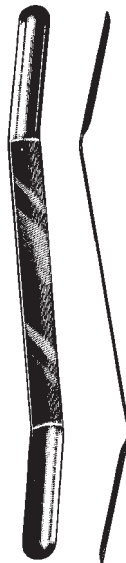

OLIVECRONA mm
 41253-07 7/ 9
 41253-11 11/13
 41253-15 15/18
 41253-18 18/22

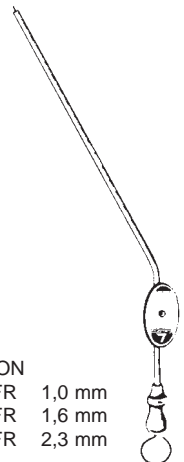

BARON
 41299-03 3FR 1,0 mm
 41299-05 5FR 1,6 mm
 41299-07 7FR 2,3 mm

Hirnspatel, Saugrohre, Punktionskanüle
 Brain Spatulas, Suction Tubes, Puncture Cannulas
 Espatulas cerebrales, Tubos de aspiración, Tubo de punción
 Spatole cerebrali, Tubi aspirazioni, cannula per punzione

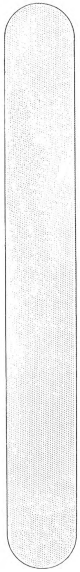

biegsam
 malleable
 maleable
 malleabile

DAVIS 18 cm, 7"

41254-06	6 mm, 1/4"
41254-10	9 mm, 3/8"
41254-13	13 mm, 1/2"
41254-16	16 mm, 5/8"
41254-19	19 mm, 3/4"
41254-25	25 mm, 1"
41254-32	32 mm, 1 1/4"
41254-38	38 mm, 1 1/2"



ADSON
 41290-21
 21 cm, 8 1/4"
 ø 4 mm



FERGUSON
 41294-40
 18 cm, 7"
 ø 4 mm, 90°

Charr.	✚	
F.G.	30°	75°
6	41295-06	41297-06
7	41295-07	41297-07
8	41295-08	41297-08
9	41295-09	41297-09
10	41295-10	41297-10
11	41295-11	41297-11
12	41295-12	41297-12
15	41295-15	

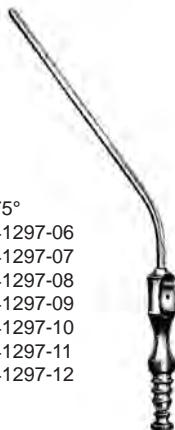

FRAZIER / FERGUSON
 41295-06 – 41297-12
 19 cm, 7 1/2"



FRAZIER / FERGUSON
 41298-12
 12 cm, 4 3/4" / 3 mm

Saugrohre
Suction Tubes
Tubos de aspiración
Tubi aspirazioni

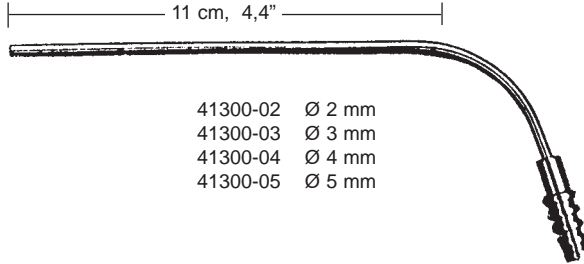

41300-02 Ø 2 mm
41300-03 Ø 3 mm
41300-04 Ø 4 mm
41300-05 Ø 5 mm

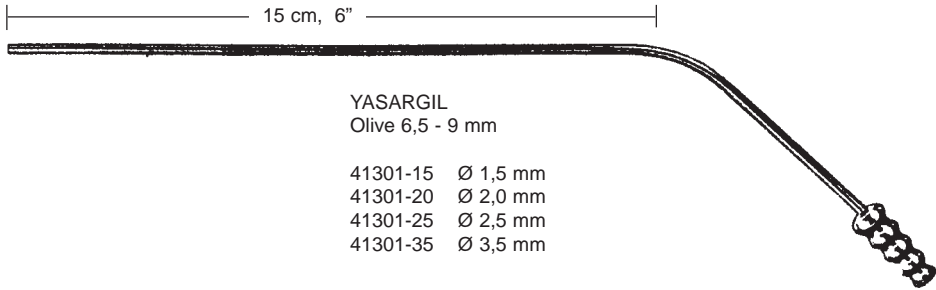

YASARGIL
Olive 6,5 - 9 mm

41301-15 Ø 1,5 mm
41301-20 Ø 2,0 mm
41301-25 Ø 2,5 mm
41301-35 Ø 3,5 mm

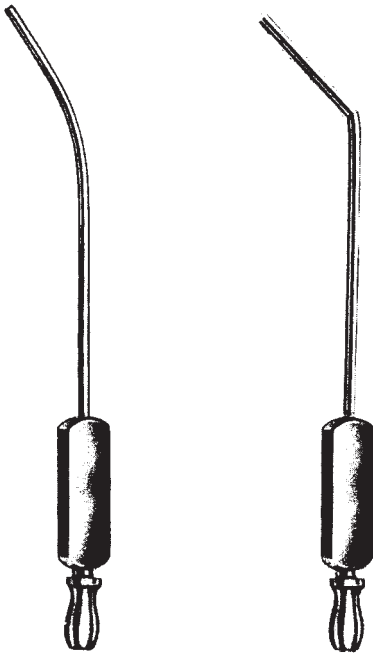

ZÖLLNER
41302-01

ZÖLLNER
41302-02



0,5 mm Ø 41306-05
0,7 mm Ø 41306-07
0,9 mm Ø 41306-09
1,2 mm Ø 41306-12

Kanüle für Sauggriff für Zöllner und Wullstein
Tip for Suction Handle for Zöllner and Wullstein
Cánula para mango t Zöllner y Wullstein
Cannula per manico di aspirazione t Zöllner e Wullstein

Saugrohre
Suction Tubes
Tubos de aspiración
Tubi aspirazioni

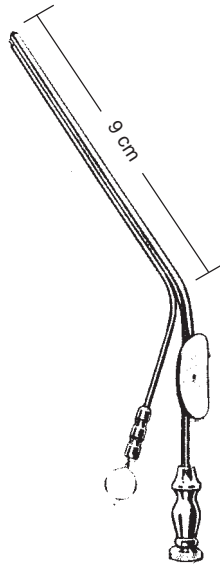

HOUSE

9 cm, 3 1/2"

41303-09	Ø 0,9 x 0,7 mm
41303-12	Ø 1,2 x 0,9 mm
41303-15	Ø 1,5 x 1,2 mm
41303-18	Ø 1,8 x 1,8 mm
41303-25	Ø 2,5 x 2,0 mm
41303-30	Ø 3,0 x 2,0 mm
41303-45	Ø 4,5 x 2,0 mm

Saugrohre, Saugkanülen
 Suction Tubes, Suction Cannulae
 Tubos de aspiración, Cánulas para aspiración
 Tubi aspirazioni, Cannule per aspirazione



Sauggriff
 Suction Handle
 Mango de aspiración
 Manico per aspirazione

WULLSTEIN
 41307-00



Kanüle für Sauggriff
 Tip for Suction Handle
 Cánula para mango
 Cannula per manico di aspirazione

ROSEN

0,5 mm Ø	41305-05	1,4 mm Ø	41305-14
0,6 mm Ø	41305-06	1,5 mm Ø	41305-15
0,7 mm Ø	41305-07	1,8 mm Ø	41305-18
0,8 mm Ø	41305-08	2,0 mm Ø	41305-20
0,9 mm Ø	41305-09	2,5 mm Ø	41305-25
1,0 mm Ø	41305-10	3,0 mm Ø	41305-30
1,2 mm Ø	41305-12		



Charr. 6 41304-06
 Charr. 8 41304-08
 Charr. 10 41304-10

PLESTER
 30°



biegsam
 malleable
 maleable
 malleabile

SCHMID
 15 cm, 6"

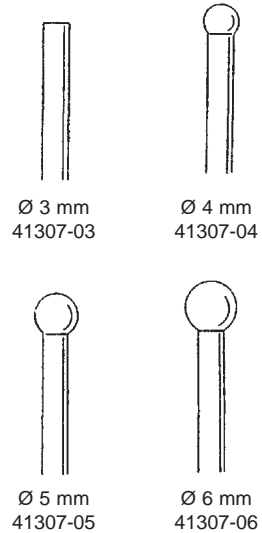

Wirbelkörperspreizer
 Lamina Spreaders
 Separadores para cuerpos vertebrales
 Divaricatori per corpi vertebrali



CLOWARD
 41401-16

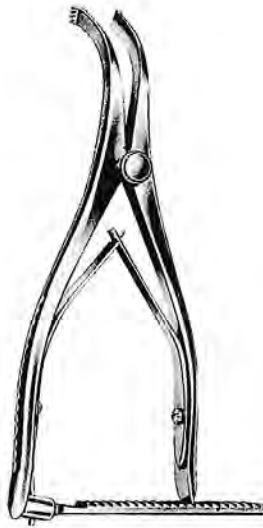

INGE
 41405-17 - 41405-27

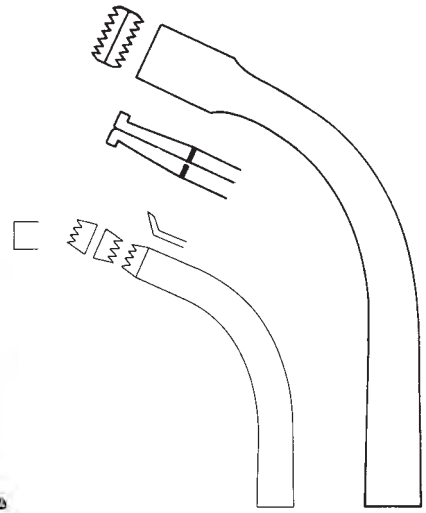

41405-17
 17 cm
 6 3/4"

41405-27
 27 cm
 10 1/2"



19 mm

CLOWARD
 41406-01
 12,5 cm, 5"

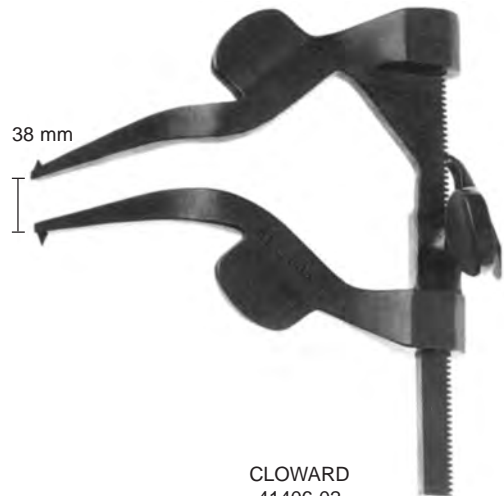

38 mm

CLOWARD
 41406-02
 7,6 cm, 3"

Laminektomie Zangen
 Laminectomy Rongeurs
 Pinzas cortantes para laminectomia
 Pinze taglienti per laminectomia

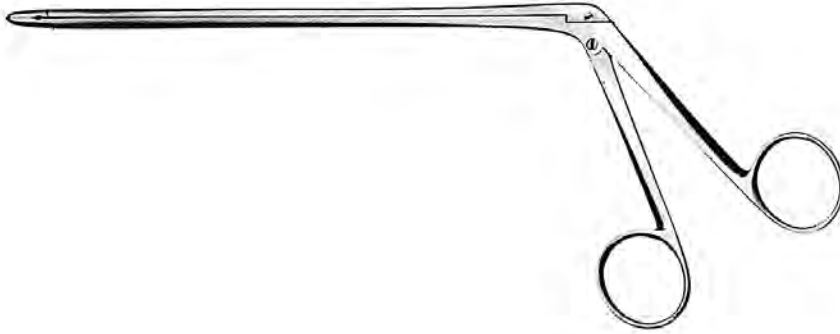

CUSHING
 2 mm



2x10 mm	L
41420-01	12,5 cm
41421-01	15,0 cm
41422-01	18,0 cm

2x10 mm/45°	L
41420-02	12,5 cm
41421-02	15,0 cm
41422-02	18,0 cm

2x10 mm/45°	L
41420-03	12,5 cm
41421-03	15,0 cm
41422-03	18,0 cm

LOVE-GRUENWALD

3 mm



3x10 mm	L
41430-01	12,5 cm
41431-01	15,0 cm
41432-01	18,0 cm

3x10 mm/45°	L
41430-02	12,5 cm
41431-02	15,0 cm
41432-02	18,0 cm

3x10 mm/45°	L
41430-03	12,5 cm
41431-03	15,0 cm
41432-03	18,0 cm

SPURLING

4 mm



4x10 mm	L
41440-01	12,5 cm
41441-01	15,0 cm
41442-01	18,0 cm

4x10 mm/45°	L
41440-02	12,5 cm
41441-02	15,0 cm
41442-02	18,0 cm

4x10 mm/45°	L
41440-03	12,5 cm
41441-03	15,0 cm
41442-03	18,0 cm

Laminektomie Zangen
 Laminectomy Rongeurs
 Pinzas cortantes para laminectomia
 Pinze taglienti per laminectomia

185 mm

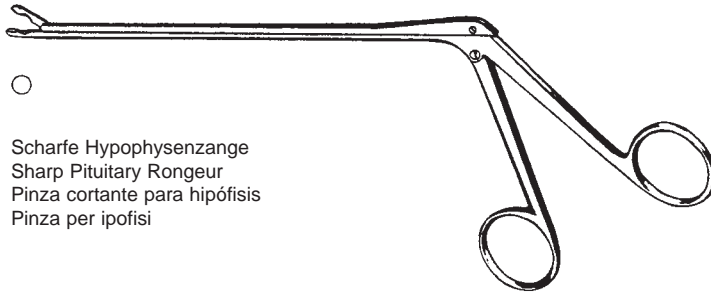

Scharfe Hypophysenzange
 Sharp Pituitary Rongeur
 Pinza cortante para hipofisis
 Pinza per ipofisi

41443-26
 25,5 cm, 10"

180 mm

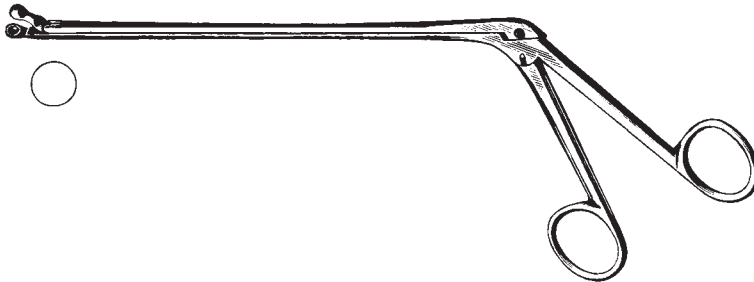

OLDBERG
 41445-25
 25 cm (9.8"), Ø 7 mm

200 mm

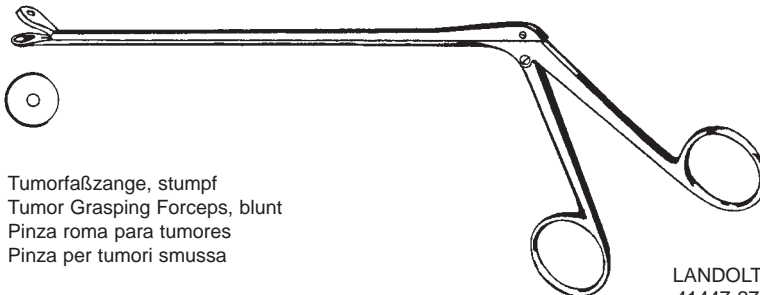

Tumorfalßzange, stumpf
 Tumor Grasping Forceps, blunt
 Pinza roma para tumores
 Pinza per tumori smussa

LANDOLT
 41447-27
 27 cm (10 1/2"), Ø 9 mm

Laminektomie Zangen
 Laminectomy Rongeurs
 Pinzas cortantes para laminectomia
 Pinze taglianti per laminectomia

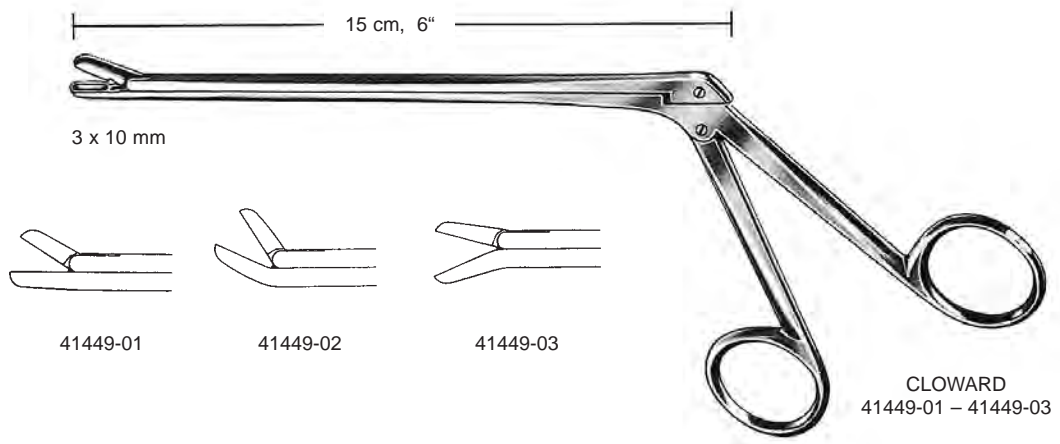
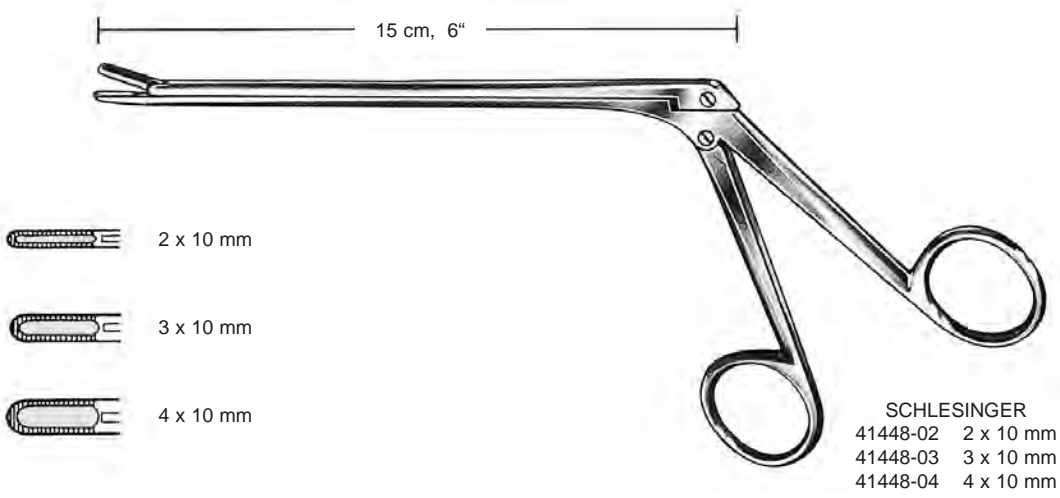

Laminektomie Zangen
 Laminectomy Rongeurs
 Pinzas cortantes para laminectomia
 Pinze taglienti per laminectomia

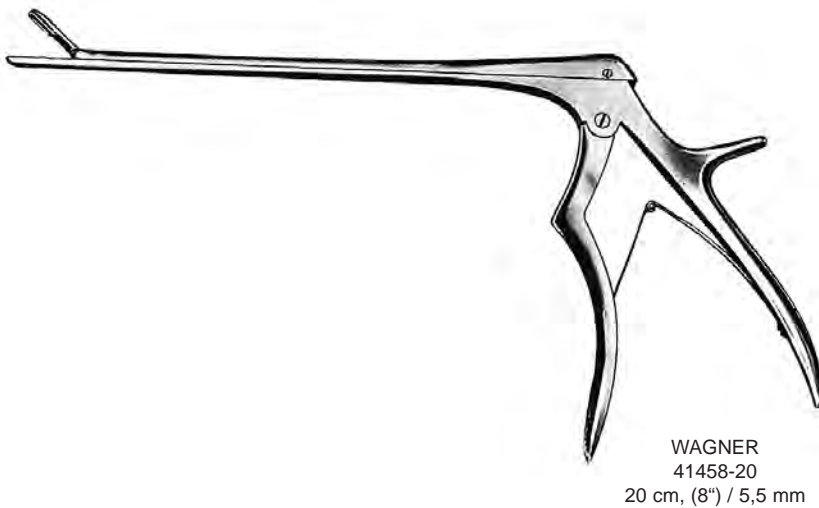
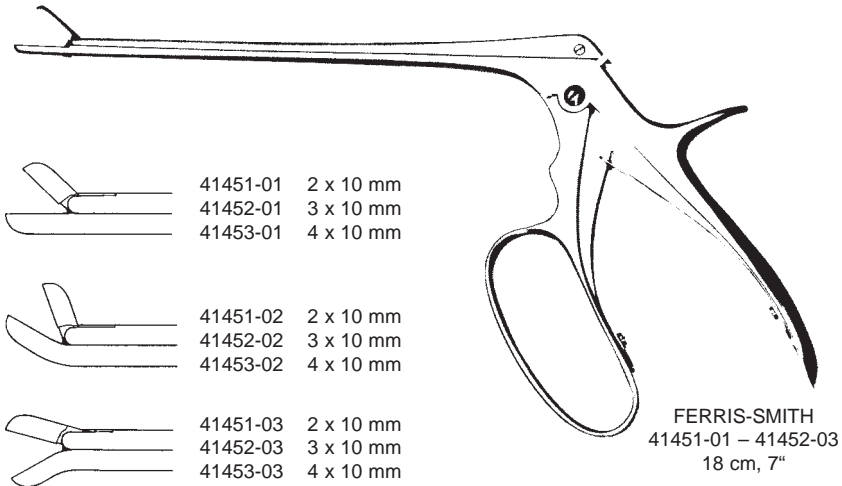

Bandscheibenstanzen
 Intervertebral Disc Rongeurs
 Pinzas sacabocado para discos intervertebrales
 Pinze taglienti per dischi intervertebrali

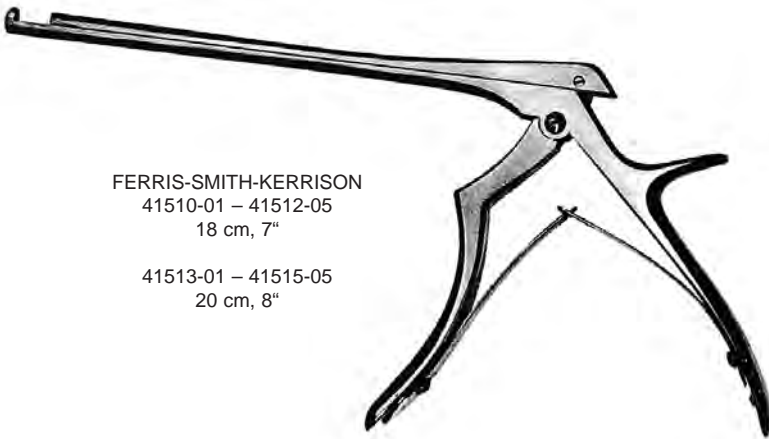

FERRIS-SMITH-KERRISON
 41510-01 – 41512-05
 18 cm, 7"

41513-01 – 41515-05
 20 cm, 8"

	90°	90°	40°
18 cm	41510-01 1 mm	41511-01 1 mm	41512-01 1 mm
20 cm	41513-01 1 mm	41514-01 1 mm	41515-01 1 mm
18 cm	41510-02 2 mm	41511-02 2 mm	41512-02 2 mm
20 cm	41513-02 2 mm	41514-02 2 mm	41515-02 2 mm
18 cm	41510-03 3 mm	41511-03 3 mm	41512-03 3 mm
20 cm	41513-03 3 mm	41514-03 3 mm	41515-03 3 mm
18 cm	41510-04 4 mm	41511-04 4 mm	41512-04 4 mm
20 cm	41513-04 4 mm	41514-04 4 mm	41515-04 4 mm
18 cm	41510-05 5 mm	41511-05 5 mm	41512-05 5 mm
20 cm	41513-05 5 mm	41514-05 5 mm	41515-05 5 mm

Bandscheibenstanzen
 Intervertebral Disc Rongeurs
 Pinzas sacabocado para discos intervertebrales
 Pinze taglianti per dischi intervertebrali

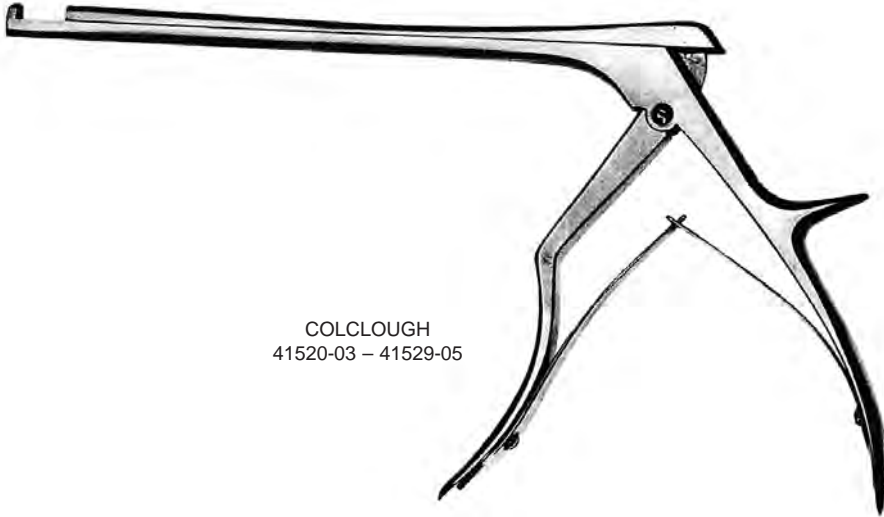

COLCLOUGH
 41520-03 – 41529-05

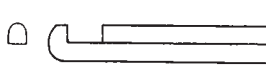

3 mm
 41520-03 15 cm, 6"
 41522-03 20 cm, 8"



5 mm
 41520-05 15 cm, 6"
 41522-05 20 cm, 8"

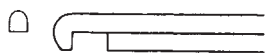

3 mm
 41524-03 15 cm, 6"
 41526-03 20 cm, 8"



5 mm
 41524-05 15 cm, 6"
 41526-05 20 cm, 8"

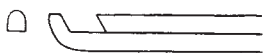

3 mm
 41527-03 15 cm, 6"
 41529-03 20 cm, 8"



5 mm
 41527-05 15 cm, 6"
 41529-05 20 cm, 8"

Zerlegbare Stanzen
 Detachable punches
 Pinzas cortantes desmontables
 Pinze taglienti e smontabili



90°



41540-02 2 mm

41540-03 3 mm

41540-04 4 mm

41540-05 5 mm

130°



41542-02 2 mm

41542-03 3 mm

41542-04 4 mm

41542-05 5 mm

YASARGIL – Aneurysmen – Gefäß – Clips
YASARGIL – Aneurysm – Vessel – Clips
YASARGIL – Clips para aneurisma
YASARGIL – Clips per aneurisma

aus hochwertigem Implantat-Stahl antimagnetisch
in high quality Implant steel antimagnetic
de acero inoxidable para implantes de alta calidad, antimagnético
Prodotto in acciaio di alta qualità, antimagnetico

Features of the Clip

SERIAL-NUMBER

Each clip is coded with an individual serial number – marked by laser technology-
The serial number guarantees a detailed follow-up of

- the whole production process
- the closure force
- from raw material to the final product

These informations are registered in our company for the period of 10 years.

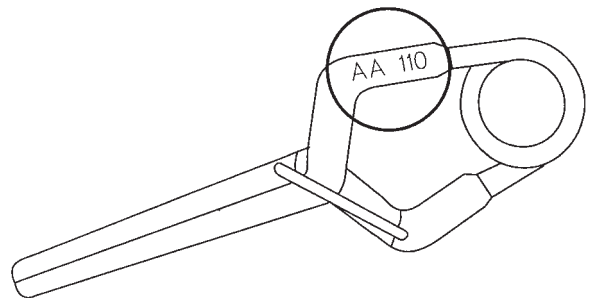

PACKING – LABELING

Each clip is individually packaged in a transparent box made of resistant plastic.
Special wishes of customers regarding the packaging will be considered by us. This will be marked on an internal instruction.

The transparent box is marked with a label in order to assure a quick and sure identification of the clip.

On the label you can find the following data:

- catalogue number
- Product description
- Illustration
- Closing force in g
- Tolerance range of closing force
- Blade length
- Maximum opening
- Blade geometry
- Serial number
- Jaw profile
- Material description
- Lot number
- the notes "NOT STERILE"
- WARNING

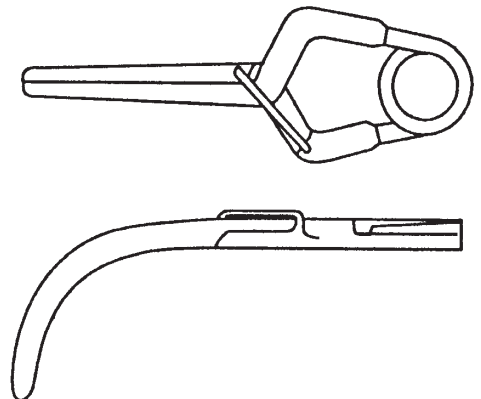

YASARGIL – Aneurysmen – Gefäß – Clips

YASARGIL – Aneurysm – Vessel – Clips

YASARGIL – Clips para aneurisma

YASARGIL – Clips per aneurisma

aus hochwertigem Implantat-Stahl antimagnetisch
in high quality Implant steel antimagnetic
de acero inoxidable para implantes de alta calidad, antimagnético
Prodotto in acciaio di alta qualità, antimagnetico

Features of the Clip

JAW-PROFILE

The rounded, pyramid-like structure is stamped into the jaw through a special step in production and prevents sharp edged which could perforate an aneurysm

No edges or burrs through additional rounding of structures that border the clip outer side because of this, real atraumatic application of the clip

Increased surface area due to the pyramid-like design of the jaws inner surface the cross-like structure of the inner jaws pyramid surface doubles the tissue-holding area.

The applied pressure distributes itself evenly over the length of the jaw.

The convex closure of the clip assures an atraumatic and secure closure of the aneurysm.

Sliding of the clip is prevented.

SPRING-DESIGN

The spring size, wich is different in the Standard and Mini clips, ist the same within the same type of the Clip.

Through this, the highest degree of a secure fit is ensured by the clip applicator (clip/clip applicator fit)

LINK-DESIGN

Laser welded

The link ensures the precise guidance of the jaws and a "soft" opening of the clip during the whole spreading process.

The contact surface of the jaws are guided symmetrically in an exact way "over the whole lenght" this fact guarantees an additional stability of the clip.

No over-stress of the material because the design of the link limits the maximum opening width.

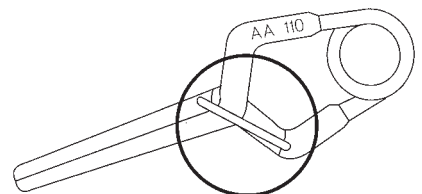
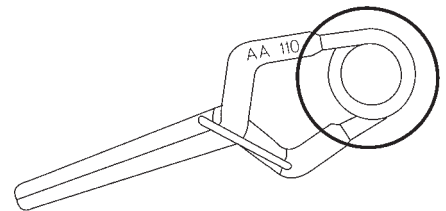
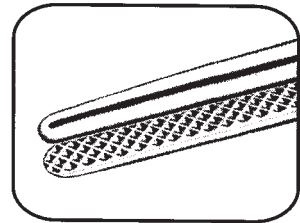
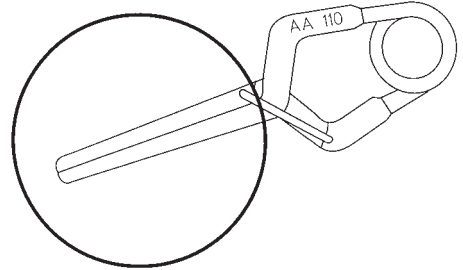

YASARGIL – Aneurysmen – Gefäß – Clips
 YASARGIL – Aneurysm – Vessel – Clips
 YASARGIL – Clips para aneurisma
 YASARGIL – Clips per aneurisma

aus hochwertigem Implantat-Stahl antimagnetisch
 in high quality Implant steel antimagnetic
 de acero inoxidable para implantes de alta calidad, antimagnético
 Prodotto in acciaio di alta qualità, antimagnetico

Features of the Clip

CLOSING-FORCE

The closing force is measured at one third of the jaw length and an opening of 0,5 mm.

The final quality control of the clip is effected by a microprocessor-controlled measuring equipment.

The closing force is indicated exactly within a certain tolerance.

By the help of a special software program we assure that before the clip passes the final quality control its closure force is fixed. As a consequence we exclude any kind of manipulation.

All relevant technical data are stored during the control procedure and printed on the label.

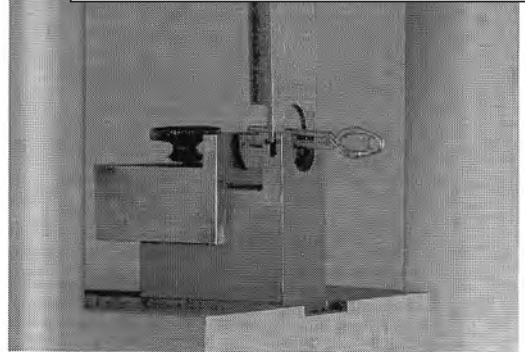
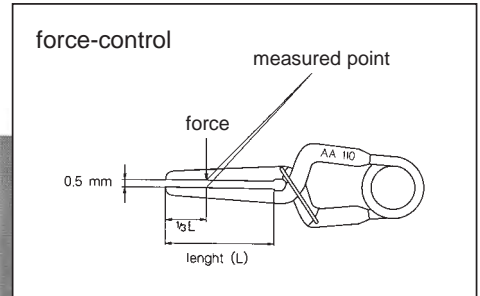

Material and Quality Assurance

According to DIN 17445, implant steel is used in the production of our Aneurysm Clip

- High stability characteristics
- Excellent tissue compatibility
- Secure closure of blood vessels
- Antimagnetic
- Ideally suited as implantation material
- Security against over straining

YASARGIL – Aneurysmen – Gefäß – Clips

YASARGIL – Aneurysm – Vessel – Clips

YASARGIL – Clips para aneurisma

YASARGIL – Clips per aneurisma

aus hochwertigem Implantat-Stahl antimagnetisch
in high quality Implant steel antimagnetic
de acero inoxidable para implantes de alta calidad, antimagnético
Prodotto in acciaio di alta qualità, antimagnetico

Erklärung zum Katalog-System

Instructions for the catalogue-system

Explicaciones para el sistema del catálogo

Esempio del sistema del catalogo

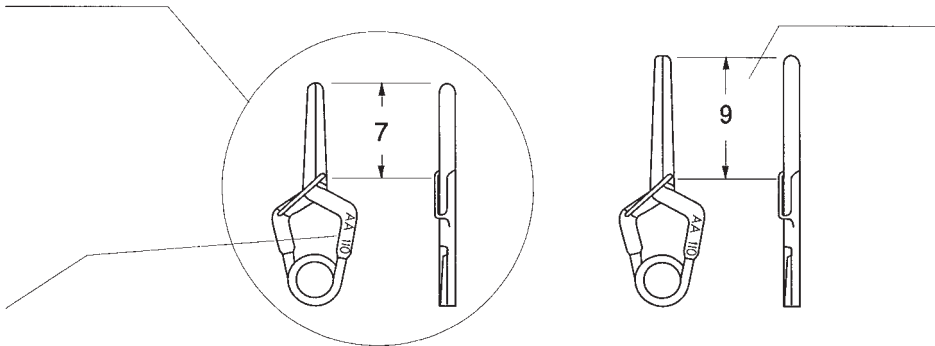

YASARGIL – Aneurysmen – Gefäß – Clips
 YASARGIL – Aneurysm – Vessel – Clips
 YASARGIL – Clips para aneurisma
 YASARGIL – Clips per aneurisma

aus hochwertigem Implantat-Stahl antimagnetisch
 in high quality Implant steel antimagnetic
 de acero inoxidable para implantes de alta calidad, antimagnético
 Prodotto in acciaio di alta qualità, antimagnetico

YASARGIL-STANDARD für permanenten Verschluss
 YASARGIL-STANDARD for permanent closure
 YASARGIL-STANDARD para cierre permanente
 YASARGIL-STANDARD con chiusura permanente

Standard

Cat. Nr.	41600-62	41600-70	41600-78	41600-92	41601-10	41601-11
	41600-62 T	41600-70 T	41600-78 T	41600-92 T	41601-10 T	41601-11 T
max. opening	6,2 mm	7,0 mm	7,8 mm	9,2 mm	10,6 mm	11,4 mm
Force	150 gms	180 gms	180 gms	200 gms	200 gms	200 gms
	41601-13	41602-60	41602-68	41602-75	41602-87	41603-55
	41601-13 T	41602-60 T	41602-68 T	41602-75 T	41602-87 T	41603-55 T
	13,3 mm	6,0 mm	6,8 mm	7,5 mm	8,7 mm	5,5 mm
	200 gms	150 gms	180 gms	180 gms	200 gms	150 gms
	41603-61	41603-65	41603-74	41604-54	41604-58	41604-62
	41603-61 T	41603-65 T	41603-74 T	41604-54 T	41604-58 T	41604-62 T
	6,1 mm	6,5 mm	7,4 mm	5,4 mm	5,8 mm	6,2 mm
	180 gms	180 gms	200 gms	180 gms	180 gms	200 gms
	41604-79	41604-87	41604-87	41604-87	41604-87	41604-87
	41604-79 T	41604-87 T	41604-87 T	41604-87 T	41604-87 T	41604-87 T
	7,9 mm	8,7 mm	8,7 mm	8,7 mm	8,7 mm	8,7 mm
	200 gms	200 gms	200 gms	200 gms	200 gms	200 gms

YASARGIL – Aneurysmen – Gefäß – Clips

YASARGIL – Aneurysm – Vessel – Clips

YASARGIL – Clips para aneurisma

YASARGIL – Clips per aneurisma

aus hochwertigem Implantat-Stahl antimagnetisch
in high quality Implant steel antimagnetic
de acero inoxidable para implantes de alta calidad, antimagnético
Prodotto in acciaio di alta qualità, antimagnetico

YASARGIL-STANDARD für permanenten Verschluss

YASARGIL-STANDARD for permanent closure

YASARGIL-STANDARD para cierre permanente

YASARGIL-STANDARD con chiusura permanente

Standard

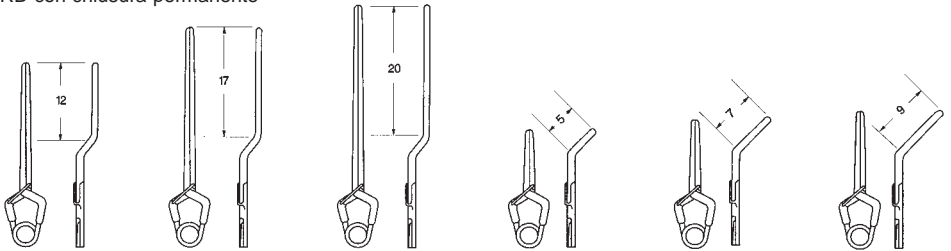

Cat. Nr.	41605-10 41605-10 T	41605-12 41605-12 T	41605-13 41605-13 T	41606-62 41606-62-T	41606-65 41606-65 T	41606-78 41606-78 T
max. opening	10,2 mm	11,9 mm	13,0 mm	6,2 mm	6,5 mm	7,8 mm
Force	200 gms	180 gms	180 gms	200 gms	200 gms	200 gms

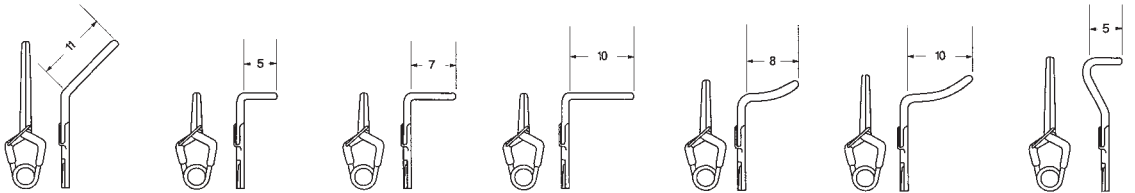

41606-84 41606-84 T	41607-56 41607-56 T	41607-57 41607-57 T	41607-58 41607-58 T	41607-59 41607-59 T	41607-60 41607-60 T	41607-72 41607-72 T
8,4 mm	5,6 mm	5,6 mm	5,6 mm	5,4 mm	5,6 mm	7,2 mm
200 gms	200 gms	200 gms	200 gms	200 gms	200 gms	200 gms

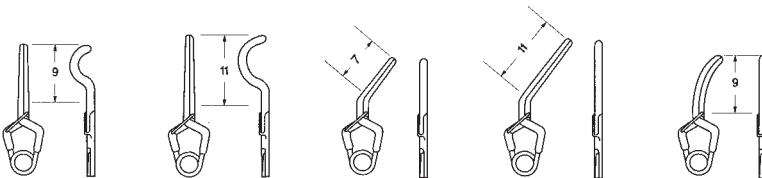

41607-73 41607-73 T	41607-82 41607-82 T	41608-57 41608-57 T	41608-80 41608-80 T	41609-70 41609-70 T
7,2 mm	8,2 mm	5,7 mm	8,0 mm	7,0 mm
200 gms	200 gms	200 gms	200 gms	200 gms

YASARGIL – Aneurysmen – Gefäß – Clips
 YASARGIL – Aneurysm – Vessel – Clips
 YASARGIL – Clips para aneurisma
 YASARGIL – Clips per aneurisma

aus hochwertigem Implantat-Stahl antimagnetisch
 in high quality Implant steel antimagnetic
 de acero inoxidable para implantes de alta calidad, antimagnético
 Prodotto in acciaio di alta qualità, antimagnetico

YASARGIL-STANDARD für temporären Verschluss
 YASARGIL-STANDARD for temporary closure
 YASARGIL-STANDARD para cierre temporal
 YASARGIL-STANDARD con chiusura temporanea

Standard

Cat. Nr.	41610-61	41610-68	41610-70	41611-74	41611-87	41611-92
	41610-61 T	41610-68 T	41610-70 T	41611-74 T	41611-87 T	41611-92 T
max. opening	6,1 mm	6,8 mm	7,0 mm	7,4 mm	8,7 mm	9,2 mm
Force	70 gms	70 gms	70 gms	70 gms	70 gms	70 gms
	41612-07	41612-09	41612-11	41612-12	41612-62	
	41612-07 T	41612-09 T	41612-11 T	41612-12 T	41612-62 T	
	7,5 mm	9,9 mm	11,0 mm	11,4 mm	6,2 mm	
	90 gms	90 gms	90 gms	90 gms	70 gms	

YASARGIL – Aneurysmen – Gefäß – Clips

YASARGIL – Aneurysm – Vessel – Clips

YASARGIL – Clips para aneurisma

YASARGIL – Clips per aneurisma

aus hochwertigem Implantat-Stahl antimagnetisch
in high quality Implant steel antimagnetic
de acero inoxidable para implantes de alta calidad, antimagnético
Prodotto in acciaio di alta qualità, antimagnetico

YASARGIL-STANDARD für permanenten Verschluss

YASARGIL-STANDARD for permanent closure

YASARGIL-STANDARD para cierre permanente

YASARGIL-STANDARD con chiusura permanente

Standard

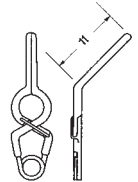
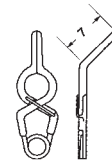
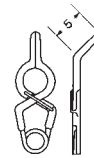
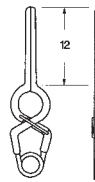
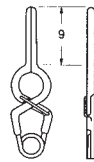
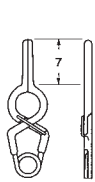

Cat. Nr.

41613-74

41613-84

41613-96

41614-58

41614-65

41614-72

41613-74 T

41613-84 T

41613-96 T

41614-58 T

41614-65 T

41614-72 T

max. opening

7,4 mm

8,4 mm

9,6 mm

5,8 mm

6,5 mm

7,2 mm

Force

150 gms

150 gms

180 gms

150 gms

150 gms

180 gms

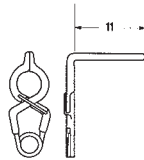
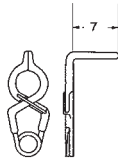
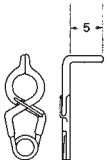

41615-49

41615-50

41615-51

41615-49 T

41615-50 T

41615-51 T

4,9 mm

4,9 mm

4,9 mm

150 gms

150 gms

180 gms

YASARGIL – Aneurysmen – Gefäß – Clips
 YASARGIL – Aneurysm – Vessel – Clips
 YASARGIL – Clips para aneurisma
 YASARGIL – Clips per aneurisma

aus hochwertigem Implantat-Stahl antimagnetisch
 in high quality Implant steel antimagnetic
 de acero inoxidable para implantes de alta calidad, antimagnético
 Prodotto in acciaio di alta qualità, antimagnetico

YASARGIL-STANDARD für permanenten Verschluss
 YASARGIL-STANDARD for permanent closure
 YASARGIL-STANDARD para cierre permanente
 YASARGIL-STANDARD con chiusura permanente

Standard

Cat. Nr.	41616-79	41616-91	41617-10	41617-65	41617-72	41617-78
	41616-79 T	41616-91 T	41617-10 T	41617-65 T	41617-72 T	41617-78 T
max. opening	7,9 mm	9,1 mm	10,3 mm	6,5 mm	7,2 mm	7,8 mm
Force	150 gms	150 gms	180 gms	150 gms	150 gms	180 gms
	41618-55	41618-56	41618-57	41618-79	41618-88	41619-00
	41618-55 T	41618-56 T	41618-57 T	41618-79 T	41618-88 T	41619-00 T
	5,5 mm	5,5 mm	5,5 mm	7,9 mm	8,8 mm	10,0 mm
	150 gms	150 gms	180 gms	150 gms	150 gms	180 gms



YASARGIL – Aneurysmen – Gefäß – Clips
 YASARGIL – Aneurysm – Vessel – Clips
 YASARGIL – Clips para aneurisma
 YASARGIL – Clips per aneurisma

aus hochwertigem Implantat-Stahl antimagnetisch
 in high quality Implant steel antimagnetic
 de acero inoxidable para implantes de alta calidad, antimagnético
 Prodotto in acciaio di alta qualità, antimagnetico

YASARGIL-STANDARD für permanenten Verschluss
 YASARGIL-STANDARD for permanent closure
 YASARGIL-STANDARD para cierre permanente
 YASARGIL-STANDARD con chiusura permanente

Standard

Cat. Nr.	41620-58	41620-59	41620-60	41620-61	41620-62	41620-63
	41620-58 T	41620-59 T	41620-60 T	41620-61 T	41620-62 T	41620-63 T
max. opening	5,8 mm	5,8 mm	5,8 mm	5,8 mm	5,8 mm	5,8 mm
Force	150 gms	150 gms	150 gms	150 gms	150 gms	150 gms
	41620-70	41620-78	41620-88	41621-58	41621-62	41622-58
	41620-70 T	41620-78 T	41620-88 T	41621-58 T	41621-62 T	41622-58 T
	7,0 mm	7,8 mm	8,8 mm	5,8 mm	6,2 mm	5,8 mm
	150 gms	150 gms	150 gms	150 gms	150 gms	150 gms
	41623-56	41624-56	41625-56	41626-56		
	41623-56 T	41624-56 T	41625-56 T	41626-56 T		
	5,6 mm	5,6 mm	5,6 mm	5,6 mm		
	150 gms	150 gms	150 gms	150 gms		

YASARGIL – Aneurysmen – Gefäß – Clips
 YASARGIL – Aneurysm – Vessel – Clips
 YASARGIL – Clips para aneurisma
 YASARGIL – Clips per aneurisma

aus hochwertigem Implantat-Stahl antimagnetisch
 in high quality Implant steel antimagnetic
 de acero inoxidable para implantes de alta calidad, antimagnético
 Prodotto in acciaio di alta qualità, antimagnetico

YASARGIL-STANDARD für permanenten Verschluss
 YASARGIL-STANDARD for permanent closure
 YASARGIL-STANDARD para cierre permanente
 YASARGIL-STANDARD con chiusura permanente

Mini

Cat. Nr.	41627-33	41627-40	41628-33	41628-40	41628-46	41629-32
	41627-33 T	41627-40 T	41628-33 T	41628-40 T	41628-46 T	41629-32 T
max. opening	3,3 mm	4,0 mm	3,3 mm	4,0 mm	4,6 mm	3,2 mm
Force	110 gms	110 gms	110 gms	110 gms	110 gms	110 gms
	41629-38	41630-36	41630-38	41631-36	41631-40	41631-44
	41629-38 T	41630-36 T	41630-38 T	41631-36 T	41631-40 T	41631-44 T
	3,8 mm	3,6 mm	3,8 mm	3,6 mm	4,0 mm	4,4 mm
	110 gms	110 gms	110 gms	110 gms	110 gms	110 gms
	41633-35	41633-40	41634-35	41634-60	41634-70	41635-57
	41633-35 T	41633-40 T	41634-35 T	41634-60 T	41634-70 T	41635-57 T
	3,5 mm	4,0 mm	3,5 mm	6,0 mm	7,0 mm	5,7 mm
	110 gms	110 gms	130 gms	130 gms	130 gms	130 gms
	41636-45					
	41636-45 T					
	4,5 mm					
	130 gms					



YASARGIL – Aneurysmen – Gefäß – Clips

YASARGIL – Aneurysm – Vessel – Clips

YASARGIL – Clips para aneurisma

YASARGIL – Clips per aneurisma

aus hochwertigem Implantat-Stahl antimagnetisch
in high quality Implant steel antimagnetic
de acero inoxidable para implantes de alta calidad, antimagnético
Prodotto in acciaio di alta qualità, antimagnetico

YASARGIL-STANDARD für temporären Verschuß

YASARGIL-STANDARD for temporary closure

YASARGIL-STANDARD para cierre temporal

YASARGIL-STANDARD con chiusura temporanea

Mini

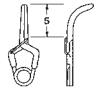
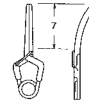

Cat. Nr.	41637-33 41637-33 T	41637-40 41637-40 T	41638-38 41638-38 T	41638-46 41638-46 T	41639-44 41639-44 T	41640-40 41640-40 T
max. opening	3,3 mm	4,0 mm	3,8 mm	4,6 mm	4,4 mm	4,0 mm
Force	50 gms	50 gms	50 gms	70 gms	70 gms	70 gms

Anlegezange mit Rundgriff – FLEXIBEL – mit und ohne drehbarem Maulteil
 Applying forceps with round shaft – FLEXIBLE – with and without Rotation
 Pinzas de aplicación con mango redondo – FLEXIBLE – con y sin rotación
 Posa clips con manico rotonda guaina FLESSIBILE cover sistema rotante ed non rotante

Länge		
Length		
Largo		
Lunghezza	MINI	STANDARD
70 mm	41641-07	41643-07
90 mm	41641-09	41643-09
110 mm	41641-11	41643-11

nicht drehbar
 non rotating
 sin rotación
 non rotante

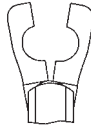

Länge		
Length		
Largo		
Lunghezza	MINI	STANDARD
70 mm	41642-07	41644-07
90 mm	41642-09	41644-09
110 mm	41642-11	41644-11

drehbar
 rotating
 rotante
 rotante

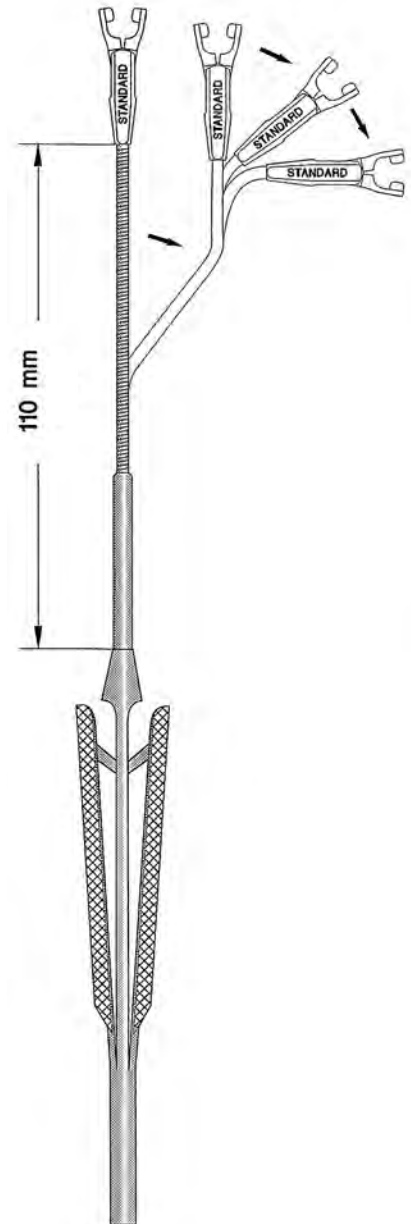
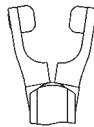

Beispiel für Drehmechanismus
 Example for Rotation
 Ejemplo de la rotación
 Esempio della rotazione

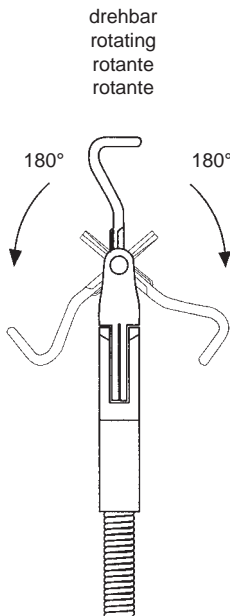

Clips drehbar im Maul
 Clips rotabile in jaw
 Clips rotabile en la boca
 Clips rotabile nel morso

41641-07 - 41644-11

Anlegezange mit Rundgriff – starr – mit und ohne drehbarem Maulteil
 Applying forceps with round shaft – rigid – with and without Rotation
 Pinzas de aplicación con mango redondo – rigido – con y sin rotación
 Posa clips con manico rotonda guaina rigida cover sistema rotante ed non rotante

Länge Length Largo Lunghezza	MINI	STANDARD
70 mm	41645-07	41647-07
90 mm	41645-09	41647-09
110 mm	41645-11	41647-11

nicht drehbar
 non rotating
 sin rotación
 non rotante

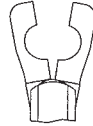

Länge Length Largo Lunghezza	MINI	STANDARD
70 mm	41646-07	41648-07
90 mm	41646-09	41648-09
110 mm	41646-11	41648-11

drehbar
 rotating
 rotante
 rotante

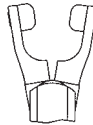

drehbar
 rotating
 rotante
 rotante

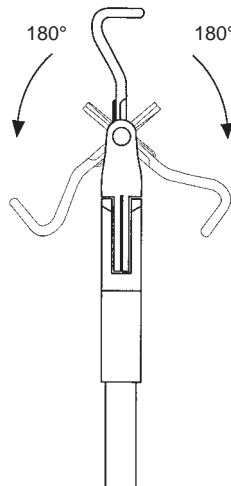

Beispiel für Drehmechanismus
 Example for Rotation
 Ejemplo de la rotación
 Esempio della rotazione

Clips drehbar im Maul
 Clips rotabile in jaw
 Clips rotabile en la boca
 Clips rotabile nel morso

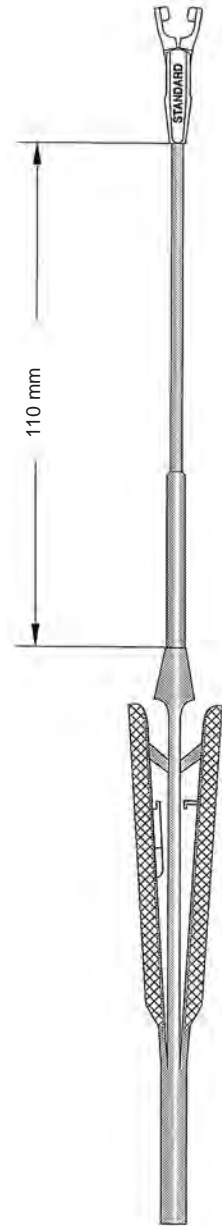

41645-07 - 41648-11

Anlegezange mit Rundgriff – starr – mit und ohne drehbarem Maulteil
 Applying forceps with round shaft – rigid – with and without Rotation
 Pinzas de aplicación con manico redondo – rigido – con y sin rotación
 Posa clips con manico rotonda guaina rigida cover sistema rotante ed non rotante

Länge		
Length		
Largo		
Lunghezza	MINI	STANDARD
70 mm	41649-07	41651-07
90 mm	41649-09	41651-09
110 mm	41649-11	41651-11

nicht drehbar
 non rotating
 sin rotación
 non rotante

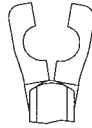

Länge		
Length		
Largo		
Lunghezza	MINI	STANDARD
70 mm	41650-07	41652-07
90 mm	41650-09	41652-09
110 mm	41650-11	41652-11

drehbar
 rotating
 rotante
 rotante

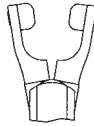

drehbar
 rotating
 rotante
 rotante

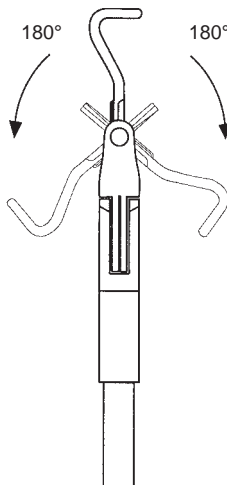

Beispiel für Drehmechanismus
 Example for Rotation
 Ejemplo de la rotación
 Esempio della rotazione

Clips drehbar im Maul
 Clips rotabile in jaw
 Clips rotabile en la boca
 Clips rotabile nel morso

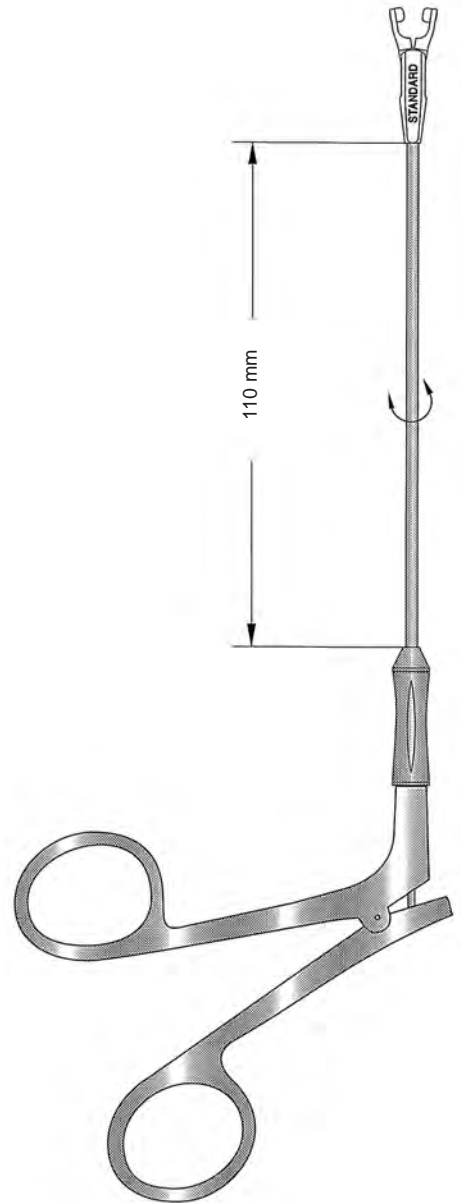

41649-07 - 41652-11

Anlegezange – mit und ohne drehbarem Maulteil
 Applying Forceps – with and without Rotation
 Pinzas de aplicación, con y sin rotación
 Pinza posa clips, con ed senza rotazione

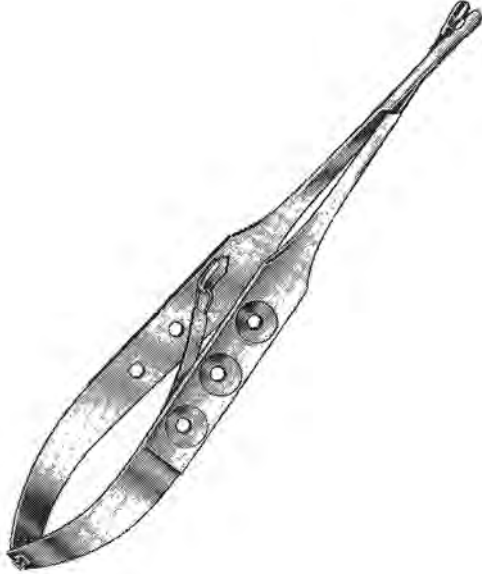

MINI	41653-18	
STANDARD	41654-18	
MINI	41655-18	drehbar / rotating rotante / rotante
STANDARD	41656-18	drehbar / rotating rotante / rotante

Anlegezange gerade, mit Sperre, Länge 18 cm, 7"
 Applying Forceps straight, with Ratchet, Length 18 cm, 7"
 Pinza de aplicación, con cremallera, 18 cm, 7"
 Posa clips, retta con bloccaggio lunghezza 18 cm, 7"





Länge			
Length			
Largo			
Lunghezza	17 cm, 6 3/4"	21 cm, 8 1/4"	23 cm, 9"
MINI	41657-17	41657-21	41657-23
STANDARD	41658-17	41658-21	41658-23
MINI	41659-17	41659-21	41659-23
	drehbar / rotating / rotante / rotante		
STANDARD	41660-17	41660-21	41660-23
	drehbar / rotating / rotante / rotante		

Clips drehbar im Maul
 Clips rotabile in jaw
 Clips rotabile en la boca
 Clips rotabile nel morso

Anlegezange bayonett, mit Sperre
 Applying Forceps bajonett, with Ratchet
 Pinza de aplicación bayoneta, con cremallera
 Posa clips a baionetta con bloccaggio

Gefäßclips nach BIEMER
 BIEMER Vessel Clips
 Clips para vasos de BIEMER
 Clips per vasi secondo BIEMER

	Maulöffnung Opening	Maullänge Length of jaws	Schließkraft Closing Force
 41661-40	Apertura de la boca Apertura del morso 4,0 mm	Largo de la boca Lunghhezza del morso 6,0 mm	Fuerza del cierre Forza di chiusura 30 - 40 g (0,29 - 0,39 N)
 41661-50	5,0 mm	9,0 mm	30 - 40 g (0,29 - 0,39 N)
 41662-50	5,0 mm	9,0 mm	20 - 25 g (0,20 - 0,25 N)

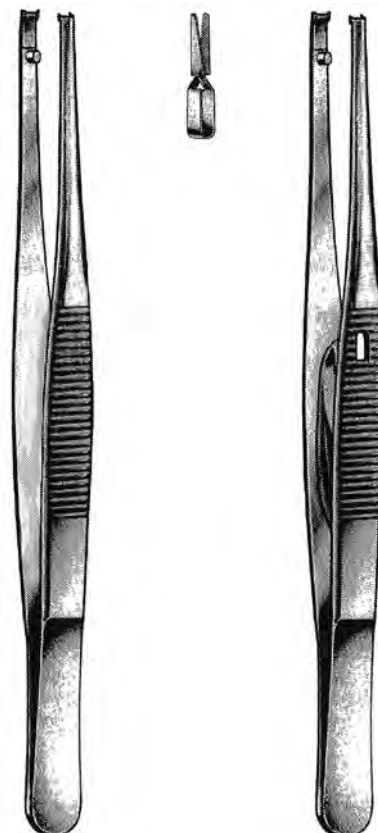

für temporären Gebrauch

gekennzeichnet durch gelb eingefärbte Federenden
 für Gefäße mit einem Durchmesser 0,5 - 2,0 mm

Maulinnenflächen schräg gerieft für schonendes,
 sicheres Festhalten der Gefäße

Der fest eingestellte Schließdruck gewährt risikofreie
 Anwendung

for temporary occlusion

(identified by yellow coloured spring ends) for vessel
 diam. 0,5 - 2,0 mm

Blade gripping surface with oblique serrations for
 save but careful gripping of vessels

No risk due to rigidly fixed pressure measure

para uso temporal

clips marcados con baño dorado en los resortes,
 para vasos con un diámetro de 0,5 - 2,0 mm

El interior de las quijadas viene con estrias finas para
 un agarre seguro y cuidadoso de los vasos

Debido a la calibración exacta de la fuerza de cierre
 se ofrece una aplicación sin riesgo

per chiusura temporanea

per vasi con Diametro 0,5 - 2,0 mm

La chiusura regolata garantisce nessun rischio

BIEMER
 41663-01

Anlegepinzette ohne Schloß,
 für Mikro-Gefäßclips
 41661-40 - 41662-50
 und
 Approximatoren
 41667-30 - 41670-50
 und
 41672-01 - 41672-04

Applying forceps without lock.
 for vessel clips
 41661-40 - 41662-50
 and
 Aproximators
 41667-30 - 41670-50
 and
 41672-01 - 41672-04

BIEMER
 41663-02

Anlegepinzette mit Schloß,
 für Mikro-Gefäßclips
 41661-40 - 41662-50
 und
 Approximatoren
 41667-30 - 41670-50
 und
 41672-01 - 41672-04

Applying forceps with lock.
 for vessel clips
 41661-40 - 41662-50
 and
 Aproximators
 41667-30 - 41670-50
 and
 41672-01 - 41672-04

Gefäßclips nach MEHDORN
MEHDORN Vessel Clips
Clips para vasos de MEHDORN
Clips secondo MEHDORN

für temporären Gebrauch

gekennzeichnet durch gelb eingefärbte Federenden für Gefäße mit einem Durchmesser 0,5 - 1,5 mm

Maulinnenflächen schräg gerieft für schonendes, sicheres Festhalten der Gefäße

Der fest eingestellte Schließdruck gewährt risikofreie Anwendung

for temporary occlusion

(identified by yellow coloured spring ends) for vessel diam. 0,5 - 1,5 mm

Blade gripping surface with oblique serrations for save but careful gripping of vessels

No risk due to rigidly fixed pressure measure

para uso temporal

clips marcados con baño dorado en los resortes, para vasos con un diámetro de 0,5 - 1,5 mm

El interior de las quijadas viene con estrias finas para un agarre seguro y cuidadoso de los vasos

Debido a la calibración exacta de la fuerza de cierre se ofrece una aplicación sin riesgo

per chiusura temporanea

per vasi con Diametro 0,5 - 1,5 mm

La chiusura regolata garantisce nessun rischio

Beispiele für die variable Position des Clips

Ejemplo para la variedad de la aplicación del clip

Esempio: posizioni variabili delle clips

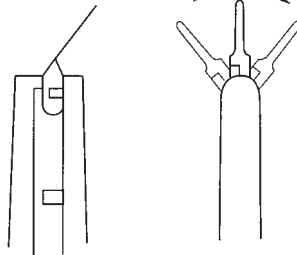

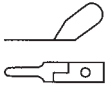
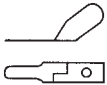
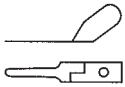
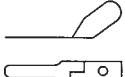
	Maullänge Length of jaws Largo de la boca Lunghezza del morso	Schließkraft Closing Force Fuerza del cierre Forza di chiusura	MEHDORN 41666-00
	41664-10 4 x 1,0 mm	10 - 15 g (0,10 - 0,15 N)	Anlegepinzette für Mikro-Gefäßclips 41664-10 - 41665-14
	41664-14 4 x 1,4 mm	15 - 20 g (0,15 - 0,20 N)	Applying Forceps for vessel clips 41664-10 - 41665-14
	41665-10 6 x 1,0 mm	10 - 15 g (0,10 - 0,15 N)	Pinza de aplicación para micro-clips 41664-10 - 41665-14
	41665-14 6 x 1,4 mm	15 - 20 g (0,15 - 0,20 N)	Pinza posa clips per microvasi 41664-10 - 41665-14

Approximatoren nach Biemer-Müller
 Approximators Biemer-Müller
 Aproximadores de Biemer-Müller
 Approssimatore secondo Biemer-Müller

für temporären Gebrauch

gekennzeichnet durch gelb eingefärbte Federenden für Gefäße mit einem Durchmesser 0,5 - 2,0 mm
 Maulinnenflächen schräg gerieft für schonendes, sicheres Festhalten der Gefäße
 Der fest eingestellte Schließdruck gewährt risikofreie Anwendung

for temporary occlusion

(identified by yellow coloured spring ends) for vessel diam. 0,5 - 2,0 mm
 Blade gripping surface with oblique serrations for save but careful gripping of vessels
 No risk due to rigidly fixed pressure measure

para uso temporal

clips marcados con baño dorado en los resortes, para vasos con un diámetro de 0,5 - 2,0 mm
 El interior de las quijadas viene con estrias finas para un agarre seguro y cuidadoso de los vasos
 Debido a la calibración exacta de la fuerza de cierre se ofrece una aplicación sin riesgo

per chiusura temporanea

per vasi con Diametro 0,5 - 2,0 mm
 La chiusura regolata garantisce nessun rischio

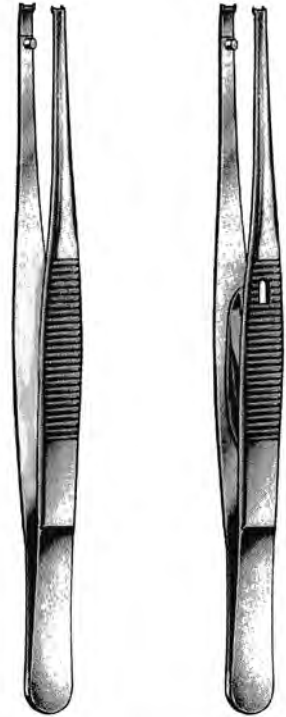

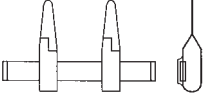
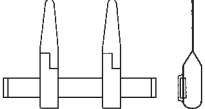
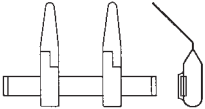
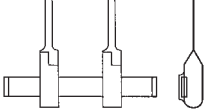
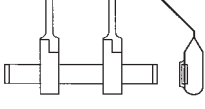
	Maulöffnung Opening	Maullänge Length of jaws	Schließkraft Closing Force
	Apertura de la boca Apertura del morso	Largo de la boca Lunghezza del morso	Fuerza del cierre Forza di chiusura
	3,0 mm	4,5 mm	30 - 40 g (0,29 - 0,39 N)
	5,0 mm	9,0 mm	30 - 40 g (0,29 - 0,39 N)
	5,0 mm	9,0 mm	30 - 40 g (0,20 - 0,25 N)
	5,0 mm	9,0 mm	30 - 40 g (0,20 - 0,25 N)
	5,0 mm	9,0 mm	30 - 40 g (0,20 - 0,25 N)

 BIEMER
 41663-01

 BIEMER
 41663-02

Anlegepinzette ohne
 Schloß,
 für Mikro-Gefäßclips
 41661-40 - 41662-50
 und
 Approximatoren
 41667-30 - 41670-50
 und
 41672-01 - 41672-04

Anlegepinzette mit
 Schloß,
 für Mikro-Gefäßclips
 41661-40 - 41662-50
 und
 Approximatoren
 41667-30 - 41670-50
 und
 41672-01 - 41672-04

Applying forceps without
 lock.
 for vessel clips
 41661-40 - 41662-50
 and
 Aproximadors
 41667-30 - 41670-50
 and
 41672-01 - 41672-04

Applying forceps with
 lock.
 for vessel clips
 41661-40 - 41662-50
 and
 Aproximadors
 41667-30 - 41670-50
 and
 41672-01 - 41672-04

Approximatoren nach Müller
Müller Approximators
Aproximadores de Müller
Aprossimatore secondo Müller

für temporären Gebrauch

gekennzeichnet durch gelb eingefärbte Federenden für Gefäße mit einem Durchmesser 0,5 - 2,0 mm
Maulinnenflächen schräg gerieft für schonendes, sicheres Festhalten der Gefäße
Der fest eingestellte Schließdruck gewährt risikofreie Anwendung

for temporary occlusion

(identified by yellow coloured spring ends) for vessel diam. 0,5 - 2,0 mm
Blade gripping surface with oblique serrations for save but careful gripping of vessels
No risk due to rigidly fixed pressure measure

para uso temporal

clips marcados con baño dorado en los resortes, para vasos con un diámetro de 0,5 - 2,0 mm
El interior de las quijadas viene con estrias finas para un agarre seguro y cuidadoso de los vasos
Debido a la calibración exacta de la fuerza de cierre se ofrece una aplicación sin riesgo

per chiusura temporanea

per vasi con Diametro 0,5 - 2,0 mm
La chiusura regolata garantisce nessun rischio

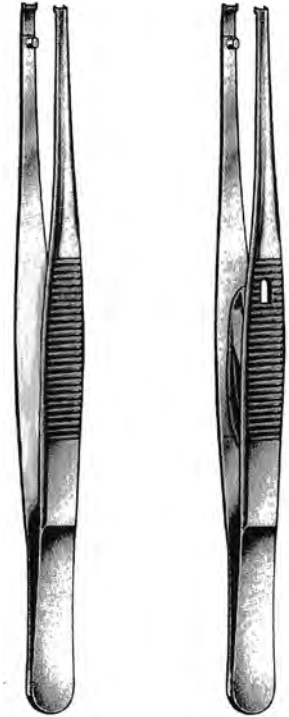

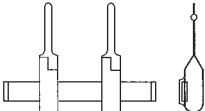
	Ø Diameter	Schließkraft Closing Force Fuerza del cierre Forza di chiusura
41672-01	1,0 mm	25 - 30 g (0,25 - 0,29 N)
41672-02	2,0 mm	25 - 30 g (0,25 - 0,29 N)
41672-03	3,0 mm	25 - 30 g (0,25 - 0,29 N)
41672-04	4,0 mm	25 - 30 g (0,25 - 0,29 N)

BIEMER
41663-01

BIEMER
41663-02

Anlegepinzette ohne
Schloß,
für Mikro-Gefäßclips
41661-40 - 41662-50
und
Approximatoren
41667-30 - 41670-50
und
41672-01 - 41672-04

Anlegepinzette mit
Schloß,
für Mikro-Gefäßclips
41661-40 - 41662-50
und
Approximatoren
41667-30 - 41670-50
und
41672-01 - 41672-04

Applying forceps without
lock.
for vessel clips
41661-40 - 41662-50
and
Aproximators
41667-30 - 41670-50
and
41672-01 - 41672-04

Applying forceps with
lock.
for vessel clips
41661-40 - 41662-50
and
Aproximators
41667-30 - 41670-50
and
41672-01 - 41672-04

Gefäßclips nach Müller
 Müller Vessel Clips
 Clips para vasos de Müller
 Clip secondo Müller

für temporären Gebrauch

Maulinnenflächen pyramidenförmig für schonendes, sicheres Festhalten der Gefäße

Der fest eingestellte Schließdruck gewährt risikofreie Anwendung

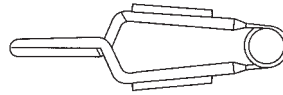

41674-50

Schließkraft
 Closing Force
 Fuerza del cierre
 Forza di chiusura

50 g

for temporary occlusion

Blade gripping surface with pyramid-like impressions for save but careful gripping of vessels

No risk due to rigidly fixed pressure measure

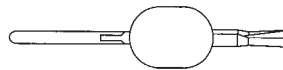

41674-80

80 g

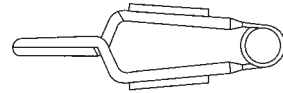

41675-50

50 g

para uso temporal

El interior de las quijadas viene en forma de pirámide para un agarre seguro y cuidadoso de los vasos.

Debido a la calibración exacta de la fuerza de cierre se ofrece una aplicación sin riesgo.

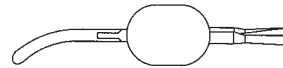

41675-80

80 g

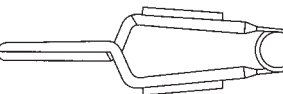

41676-50

50 g

per uso temporaneo

Morso interno con forma piramidale per garantire una chiusura sicura del vaso

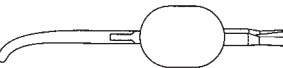

41676-80

80 g

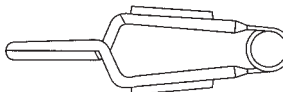

41677-50

50 g

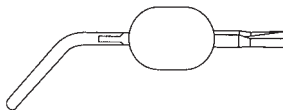

41677-80

80 g

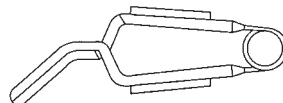

41678-50

50 g

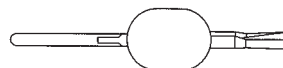

41678-80

80 g

Approximator nach Biemer
 Biemer Approximator
 Aproximadores de Biemer
 Approssimatore secondo Biemer

für Mikro-Gefäßanastomosen im oberflächlichen Bereich

Maulinnenflächen schräg gerieft für schonendes, sicheres Festhalten der Gefäße

Der fest eingestellte Schließdruck gewährt risikofreie Anwendung

Der Abstand zwischen den Clips ist durch einfaches Verschieben einzustellen und wird durch Verkanten fixiert

for micro vessel anastomosis in the superficial range

Blade gripping surface with oblique serrations for save but careful gripping of vessels

No risk due to rigidly fixed pressure measure

Adjustable distance between the clips and automatic fixation by tilting

para micro-anastomosis en la superficie

El interior de la quijada viene con estrias finas para un agarre seguro y cuidadoso de los vasos.

Debido a la calibración exacta de la fuerza de cierre se ofrece una aplicación sin riesgo.

El espacio entre los clips se logra fácilmente por el desplazamiento.

per micro vasi anastomosi sulla parte della superficie

Parte interna del morso è leggermente striata obliqua per ottenere la presa sulla superficie del vaso.

La chiusura regolata garantisce nessun rischio.

Lo scorrimento delle due clips viene regolato con semplice movimento che consente una chiusura ottimale.



BIEMER
 41680-00

Anlegepinzette für Gefäß-
 Approximator nach BIEMER

Applying forceps for BIEMER
 vessel approximator

Pinza de aplicación para
 aproximadores de BIEMER

Pinza posa clips per vasi
 approssimatori secondo
 BIEMER

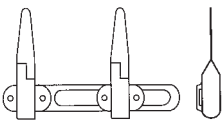

41679-25

Schließkraft
 Closing Force
 Fuerza de cierre
 Forza di chiusura

25 - 30 g
 (0,25 - 0,29 N)

LEYLA Retraktor System
 LEYLA Retractor System
 Separador de sistema LEYLA
 LEYLA Sistema di fissaggio

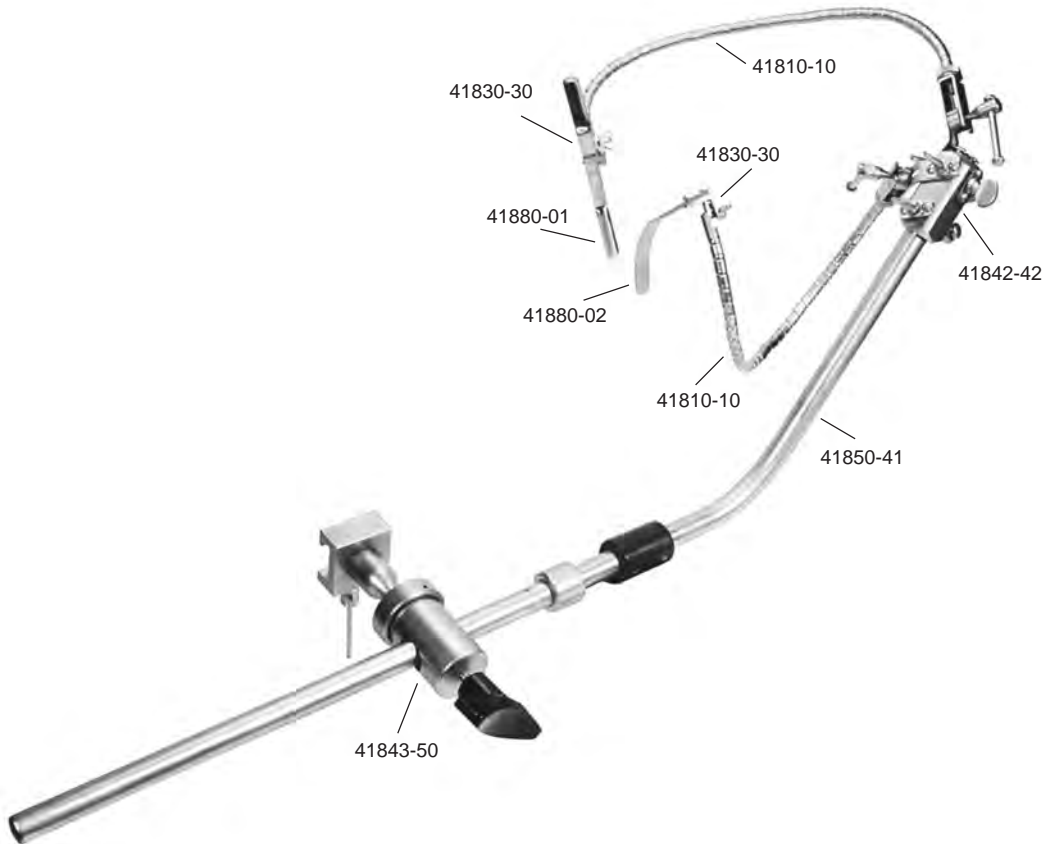

- 41802-00 LEYLA-Retraktor-System zum Fixieren am OP-Tisch komplett, bestehend aus:
 LEYLA Self-Retraining Retractor for fixation to operating table, complete, consisting of:
 Separador LEYLA para fijacion a la mesa de operaciones, completo, compuesto de:
 LEYLA Sistema di fissaggio al tavolo operatorio, composto da:
- | | | | |
|----------|--|----------|---|
| 41843-50 | Kugelgelenkkloben (1x)
ball and socket joint (1x)
articulacion esferica (1x)
giunto per fissare (1x) | 41830-30 | Spatelhalter für flache Spatel (2x)
support for flat brain spatula (2x)
soporte para espátulas cerebrales planas (2x)
sostegno per spatole piatte (2x) |
| 41850-41 | starrer Haltearm (1x)
rigid holding rod (1x)
brazo de fijación rigido (1x)
braccio di fissaggio rigido (1x) | 41880-01 | CUSHING Hirnspatel (1x)
CUSHING brain spatula (1x)
CUSHING espátula para cerebro (1x)
CUSHING spatola cerebrale (1x) |
| 41842-42 | Kupplungskopf (1x)
coupling head (1x)
cabeza de acoplamiento (1x)
giunto per combinare (1x) | 41880-02 | CUSHING Hirnspatel (1x)
CUSHING brain spatula (1x)
CUSHING espátula para cerebro (1x)
CUSHING spatola cerebrale (1x) |
| 41810-10 | flexibler Spannarm (2x)
flexible arm, only (2x)
brazo flexible, suelto (2x)
braccio flessibile, solo (2x) | | |

LEYLA Retraktor System
 LEYLA Retractor System
 Separador de sistema LEYLA
 LEYLA Sistema di fissaggio



41843-50 Kugelgelenkkloben
 zum Befestigen an der OP-Tischschiene und zur Aufnahme
 des Haltearms 41850-41
 ball and socket joint
 for fixation of holding rod 41850-41 at the operating table
 articulation esferica, para sujetar el brazo de soporte rigido
 sobre la mesa de operaciones 9 x 32 mm
 giunto per fissare il braccio, articolato 9 x 32 mm

41850-41 starrer Haltearm, auseinandernehmbar, zur Fixation im
 Kugelgelenkkloben 41843-50 und zur wahlweisen
 Aufnahme der Kupplungsköpfe 41842-42, 41842-44
 und 41842-46

holding rod, detachable, for fixation in ball and socket joint
 41843-50 and to hold a desired coupling head
 41842-42, 41842-44 or 41842-46

brazo de soporte rigido, desmontable, para fijacion a la
 articulacion esferica 41843-50 y opcionalmente a las
 cabezas 41842-42, 41842-44 y 41842-46

braccio di sostegno rigido, per fissaggio al giunto 41843-50
 e dei giunti 41842-42, 41842-44 e 41842-46



41842-42 Kupplungskopf, zur Aufnahme von max. 5 flexiblen
 Spannarmen 41810-10
 coupling head to hold 5 flexible arms 41810-10
 cabeza de acoplamiento para fijar hasta 5 brazos flexibles
 giunto per combinare 5 bracci

41842-44 Kupplungskopf, drehbar, zur Aufnahme von 1 flexiblen
 Spannarm 41810-10
 coupling head, turnable, to hold 1 flexible arm 41810-10
 acoplamiento, girable y se puede fijar en todas las posturas
 para sujetar un brazo flexible 41810-10
 giunto per combinare, rotabile, per sostegno del braccio
 41810-10

41842-46 Kupplungskopf, seitlich offen zur Aufnahme von 1 flexiblen
 Spannarm 41810-10
 coupling head, lateral open, to hold 1 flexible arm 41810-10
 acoplamiento, abierto al lado, para un brazo flexible
 41810-10
 giunto per fissare il braccio, per 41810-10

LEYLA Retraktor System
 LEYLA Retractor System
 Separador de sistema LEYLA
 LEYLA Sistema di fissaggio



41801-01 Hirnspatelhalter, flexibel, für 1 flachen Spatel, komplett, bestehend aus:
 brain retractor, flexible, for 1 flat spatula, complete, consisting out of:
 separador autoretentivo, flexible, para espátula con 1 brazo flexible,
 completo, compuesto de:
 divaricatore autostatico, flessibile, per spatole piatte, con 1 braccio flessibile, completo, composto da:

41810-10 flexibler Spannarm
 flexible arm, only
 brazo flexible, suelto
 braccio flessibile, solo

41826-26 Fixiervorrichtung für 1 flexiblen Spannarm
 fixation Base for 1 flexible arm
 fijador para 1 brazo flexible
 fissatore per 1 braccio al braccio rigido

41830-30 Spatelhalter für flache Spatel
 support for flat brain spatula
 soporte para espátulas cerebrales planas
 sostegno per spatole piatte



41802-02 Hirnspatelhalter, flexibel für 2 flache Spatel, komplett, bestehend aus:
 brain retractor, flexible, for 2 flat spatulas, complete, consisting out of:
 separador autoretentivo, flexible, para 2 espátulas planas con 2
 brazos flexibles, completo, compuesto de:
 divaricatore autostatico, flessibile, per spatole piatte, con 2 bracci
 flessibili, completo, composto da:

41810-10 flexibler Spannarm (2x)
 flexible arm, only (2x)
 brazo flexible, suelto (2x)
 braccio flessibile, solo (2x)

41822-22 Fixiervorrichtung für 2 flexible Spannarme
 fixation Base for 2 flexible arms
 fijador para 2 brazos al cráneo
 fissatore per 2 bracci al cranio

41830-30 Spatelhalter für flache Spatel (2x)
 support for flat brain spatula (2x)
 soporte para espátulas cerebrales planas (2x)
 sostegno per spatole piatte (2x)

LEYLA Retraktor System
 LEYLA Retractor System
 Separador de sistema LEYLA
 LEYLA Sistema di fissaggio



- 41810-10 flexibler Spannarm
flexible arm, only
brazo flexible, suelto
braccio flessibile, solo

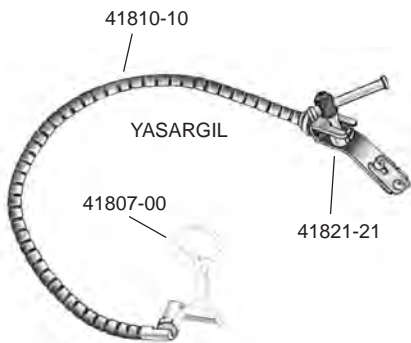

- 41803-01 Ohrspekulahalter, komplett, bestehend aus:
ear specula holder, complete, consisting out of:
soporte para especulos auriculares completo, compuesto de:
sostegno per specolo auricolare, completo composto da:
- 41810-10 flexibler Spannarm
flexible arm, only
brazo flexible, suelto
braccio flessibile, solo
- 41821-21 Fixiervorrichtung zum Befestigen an Rohrteilen bis Ø 16 mm
clamp for fixation on bars up to Ø 16 mm
fijador para 1 brazo flexible, para atornillar a tubos hasta 16 mm
fissatore al braccio rigido Ø 16 mm
- 41807-00 Ohrtrichterhalter, allein
ear specula holder, only
soporte para especulos auriculares, suelto
sostegno per specolo auricolare

LEYLA Retraktor System
 LEYLA Retractor System
 Separador de sistema LEYLA
 LEYLA Sistema di fissaggio

41821-21

Fixiervorrichtung an Rohrteilen bis \varnothing 16 mm, für 1 flexiblen Spannarm
 Fixation base for mounting on bars up to \varnothing 16 mm, for 1 flexible arm
 Fijador para 1 brazo flexible, para atornillar a tubos hasta 16 mm
 Fissatore per 1 braccio al braccio rigido



41822-22

Fixiervorrichtung am Schädel für 2 flexible Spannarme
 Fixation Base for skull mounting, holding 2 flexible arms
 Fijador para 2 brazos al cráneo
 Fissatore per 2 bracci al cranio



41826-26

Fixiervorrichtung am Schädel für 1 flexiblen Spannarm
 Fixation Base for skull mounting, holding 1 flexible arm
 Fijador para 1 brazo al cráneo
 Fissatore per 1 braccio al cranio



41830-30

Halter für flache Hirnspatel
 Support for flat brain spatula
 Soporte para espátulas cerebrales planas
 Sostegno per spatole piatte



41832-32

Halter für Hirnspatel mit rundem Schaft
 Support for brain spatula with round shaft
 Soporte para espátulas cerebrales con mango redondo
 Sostegno per spatola cerebrale



Hirnspatel
Brain Spatulas
Espátula Cerebral
Spatole Cerebrali



HEIFETZ
200 mm
8"

	Breite width ancho larghezza	Gesamtlänge total length largo total lunghezza totale
41860-14	14 mm	200 mm
41860-17	17 mm	200 mm
41860-20	20 mm	200 mm

biegsam
malleable
maleable
malleabili



HEIFETZ
155 mm
6"

	Breite width ancho larghezza	Gesamtlänge total length largo total lunghezza totale
41870-08	8 mm	155 mm
41870-11	11 mm	155 mm
41870-14	14 mm	155 mm
41870-17	17 mm	155 mm

biegsam
malleable
maleable
malleabili

	Breite width ancho larghezza	Gesamtlänge total length largo total lunghezza totale
41880-01	9 mm	200 mm
41880-02	12 mm	200 mm
41880-03	12 mm	250 mm

biegsam
malleable
maleable
malleabili



CUSHING
200 mm, 8"

Lidsperrer
Eye Specula
Blefaróstatos
Blefarostati

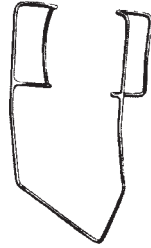

BARRAQUER (Colibri)

43101-03 3 cm, 1.2" für Kinder / children / niños / bambini
43101-04 4 cm, 1.6" für Erwachsene / adults / adultos / adulti



BOWMAN

43104-07
7 cm, 2 3/4"

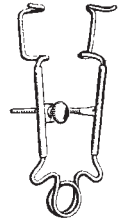

CRITCHETT

43105-06
7 cm, 2 3/4"



SMITH
43106-05
5 cm, 2"

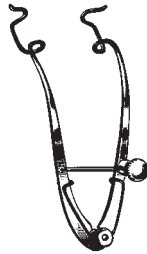

CLARK
43107-08
8 cm, 3 1/8"



GRAEFE
43109-07 7 cm, 2 3/4"
43109-09 9 cm, 3 1/2"



WEEK
43110-08
8 cm, 3 1/8"

rechts
right
a la derecha
destro

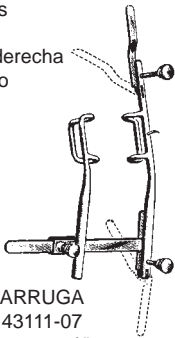

ARRUGA
43111-07
7 cm, 2 3/4"

links
left
a la izquierda
sinistro

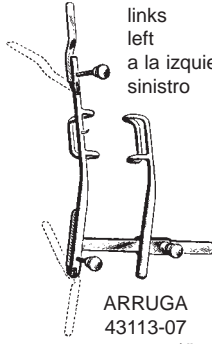

ARRUGA
43113-07
7 cm, 2 3/4"

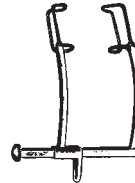

MURDOCK
43115-05
5 cm, 2"

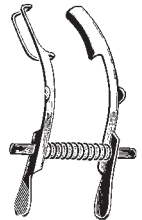

MELLINGER-AXENFELD
43121-07
7 cm, 2 3/4"

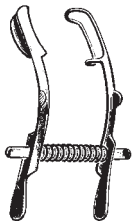

MELLINGER-AXENFELD
43123-07
7 cm, 2 3/4"

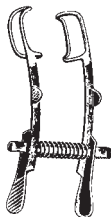

MELLINGER
43125-05 5 cm, 2"
43125-07 7 cm, 2 3/4"



LISTER-BURCH
43127-08
8 cm, 3 1/8"

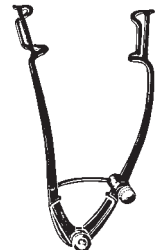

WILLIAMS
43128-08
8 cm, 3 1/8"

Lidsperrer, Lidplatte, Starmesser
 Eye Specula, Lid Plate, Cataract Knives
 Blefaróstatos, Placa para párpados, cuchillos para cataratas
 Blefarostati, Placca per palpebre, coltelli per cataratta

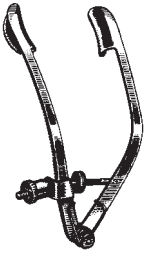

LANCASTER
 43129-07
 7 cm, 2 3/4"



ZIEGLER
 43130-07
 7 cm, 2 3/4"



CASTROVIEJO
 43132-08
 8 cm, 3 1/8"

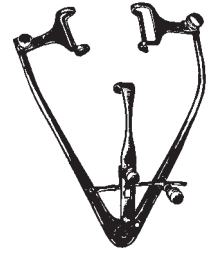

PARK
 43133-08
 8 cm, 3 1/8"



MUELLER
 43135-07
 7 cm, 2 3/4"



STEVENSON
 43139-07
 7 cm, 2 3/4"



LIEBERMAN
 43140-08
 8 cm 3 1/8"



LIEBERMAN
 43141-08
 8 cm 3 1/8"



JAEGER
 43150-11
 11 cm, 4 3/8"



GRAEFE
 43170-00 - 43170-03
 13 cm, 5 1/8"



43170-00



43170-01



43170-02



43170-03



DEUTSCHMANN
 43172-13
 13 cm, 5 1/8"

Lanzenmesser, Diszisionsmesser, Irismesser, Diszisionsmesser
 Cataract knife, keratome, Iris knife, discision knife
 Cuchillos lanceolares y Cuchillos de discisión
 Cheratom, bisturi p. capsule, bisturi corneale



JAEGER
 43180-01 Fig. 1 13 cm, 5 1/8"
 43180-02 Fig. 2 13 cm, 5 1/8"
 43180-03 Fig. 3 13 cm, 5 1/8"

JAEGER 45°
 43181-01 Fig. 1
 43181-02 Fig. 2
 43181-03 Fig. 3

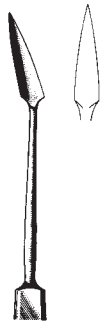

BERENS
 43183-13
 13 cm, 5 1/8"



CASTROVIEJO
 43185-13 13 cm
 4 x 13 mm



GRAEFE
 43187-13
 13 cm, 5 1/8"

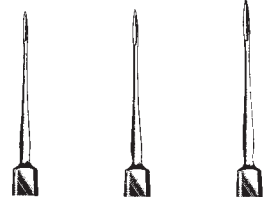

KNAPP
 43202-01 Fig. 1 13 cm, 5 1/8"
 43202-02 Fig. 2 13 cm, 5 1/8"
 43202-03 Fig. 3 13 cm, 5 1/8"

43180-01 - 43181-03



ZIEGLER
 43210-01 5 mm
 Fig. 1
 13 cm, 5 1/8"



ZIEGLER
 43210-02 6 mm
 Fig. 2
 13 cm, 5 1/8"



ZIEGLER
 43210-03 7 mm
 Fig. 3
 13 cm, 5 1/8"



DEAN
 43213-12
 12,5 cm, 5"



BOWMAN
 43214-04 13 cm
 0,4 mm
 13 cm, 5 1/8"



BOWMAN
 43214-08 13 cm
 0,8 mm
 13 cm, 5 1/8"

Hornhautmesser, Hornhautschaber, Dissektor, Sklerotom, Goniotomiemesser
 Corneal Scarifier, -dissector, sclerotome, goniotomy knife
 Cuchillos para cornea, legas corneales, esclerótomos
 Spatole p. corneale, dissettore corneale, sclerotomo, coltello per goniotomia



WHEELER
43218-12
12 cm, 4 3/4"



ZIEGLER
43221-11
11 cm, 4 3/8"
3,5 mm



SATO
43226-12
12,5 cm, 5"



TOOK
43228-12
12 cm, 4 3/4"



GILL
43231-12
12 cm, 4 3/4"



ELSCHNIG
43233-13
13 cm, 5 1/8"



KUHNT
43240-01
Fig. 1



KUHNT
43240-02
Fig. 2



KUHNT
43240-03
Fig. 3



KUHNT
43240-04
Fig. 4



PATON
43245-12
12 cm, 4 3/4"



LUNDSGAARD
43251-12
12 cm, 4 3/4"



GUYTON-
LUNDSGAARD
43253-12



BARKAN
43256-12



SCHEIE
43258-12



BURCH
43262-12



PAUFIQUE
43271-11



BARRAQUER
43273-13

Diszisionsnadeln, Fremdkörpernadeln, Fremdkörperhohlmeißel
 Discision Needles, Foreign-Body Instruments
 Aguja de discisión, Instrumental para cuerpos extraños
 Aghi per discisione, strumenti per corpi estranei



43304-12



43305-12

BOWMAN
43308-12BOWMAN
43309-12

43310-13



43311-13

LEVINSON
43314-13FRANCIS
43321-12DAVIS
43325-13LA FORCE
43327-12DIX
43330-13ELLIS
43331-11WALTON
43332-12
1,4 mmWALTON
43334-12
1,4 mmALVIS
43336-12GREEN
43340-13ROLLET
43342-12

Schielhaken, Tenotomiehaken, Extraktionshaken, Tränensackhäkchen
 Strabismus hook, lens hook, extraction hook
 Ganchos para estrabismo, - cristalino, extracción
 Uncino per il strabismo, uncino p. cristallino, protettori, uncini per l'iride



Fig. 1
 GRAEFE
 43351-01
 13 cm, 5 1/8"



Fig. 2
 GRAEFE
 43351-02
 14 cm, 5 1/2"



Fig. 3
 GRAEFE
 43351-03
 15 cm, 6"



JAMESON
 43353-13



GREEN
 43355-13



STEVENS
 43357-13



Fig. 1
 ARRUGA
 43363-01



Fig. 2
 ARRUGA
 43363-02



O'CONNER
 43370-12



WIENER
 43372-13



WIENER
 43373-13



ROLLET
 43376-13



KNAPP
 43377-13



GRAEFE
 43380-13



GRAEFE
 43381-13



GRAEFE
 43383-13



BECKER
 43386-13

Implantations Instrumente
 Instruments for Implantation
 Instrumentos para implantaciòn
 Strumenti per impianto

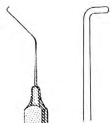

CLAYMAN
 43387-02
 11,5 cm 4 1/2"



SINSKEY
 43388-02
 11,4 cm 4 1/2"



SINSKEY
 43389-02
 12 cm 4 3/4"

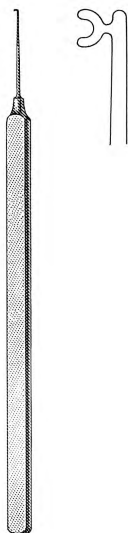

KUGLEN
 43390-05
 11,7 cm 4 5/8"

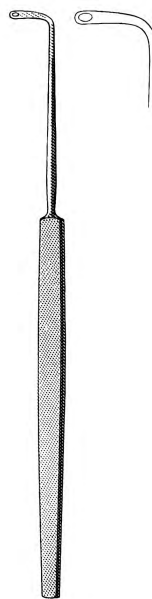

GASS
 43391-13
 14,6 cm 5 3/4"

Küretten und Löffel für Chalazion und Star
 Scoops and Curettes for Chalazio, Cataract, and Exenteration
 Curetas y cucharillas para chalazión, catarata y exenteración
 Curette e cucchiari per calazio, cateratta e palpebre

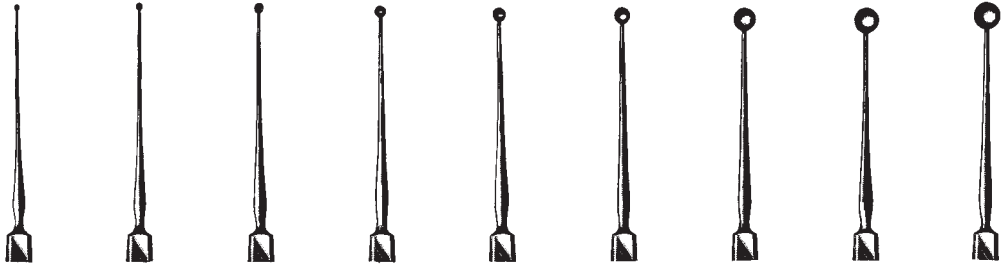

MEYHOEFER

	43402-05	43402-10	43402-15	43402-18	43402-20	43402-25	43402-35	43402-40	43402-45
Ø mm	0,5	1,0	1,5	1,8	2,0	2,5	3,5	4,0	4,5



	HEBRA	HEBRA	HEBRA	HEBRA	HEBRA
	43404-10	43404-20	43404-24	43404-30	43404-35
Ø mm	1,0	2,0	2,5	3,0	3,5



AXENFELD
43407-13



GRAEFE
43410-01



GRAEFE
43410-02



DAVIEL
43412-01
3 mm



DAVIEL
43412-02
4 mm

Starlöffel, Exenterationslöffel, Drahtschlingen, Starschlingen, Irisspatel, Enukleationslöffel, Wundlöffel
 Cataract Spoon, Exenteration Scoops, Lens Scoops, Spatulas, Protectores
 Cucharillas para Catarata-, exenteración, Asas, Espátulas, Protectores
 Cucchiaino per cataratta- esenterazione, Anse, Spatole, Protettori



KNAPP
43414-02



BUNGE
43420-01



BUNGE
43420-02



BUNGE
43420-03



LANG
43424-13



WEBER
43441-01
Fig. 1



43441-02
Fig. 2



SNELLEN
43443-13



WILDER
43445-13
Fig. 1



43447-13
Fig. 2



ARLT



43449-01



43449-02

Cautery
Cauter
Cauterio

Iris
Iride



WECKER
43461-13



WECKER
43462-13



CULLER
43467-13



WELLS
43482-20



ARRUGA
43485-13



WADSWORTH-TODD
43487-14

Zyklodialysespatel, Fremdkörperinstrumente
 Cyclodialysis Spatula, Foreign Body Instruments
 Espátulas para ciclodiálisis, Instrumentos para cuerpos extraños
 Spatole per ciclodialisi, Strumenti per corpi estranei



BANGERTER



43501-06
6 mm



43501-10
10 mm



43501-12
12 mm



43511-13 - 43517-09



CASTROVIEJO
43511-13
1,2 x 10 mm



CASTROVIEJO
43513-14
1,5 x 15 mm



ELSCHNIG
43515-14
1,2 x 12 mm



CASTROVIEJO
43517-09
0,8 x 15 mm



CASTROVIEJO
43521-12
12 cm, 4 3/4"

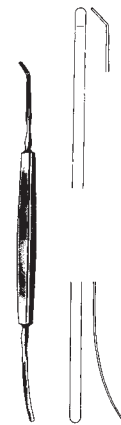

WHEELER
43523-12
12 cm, 4 3/4"



HIRSCHMAN
43524-10
12,5 cm, 5"



CASTROVIEJO
43525-05 0,50 mm
43525-07 0,75 mm
43525-10 1,00 mm



BECHERT
43526-12
12,5 cm, 5"

Fremdkörperinstrumente, Meßzirkel, Kapselstanze
 Foreign- Body Instruments, Markers, Corneoscleral punch
 Instrumental para cuerpos extraños, Compás de la cápsula, Pinza para capsuloiridectom
 Strumenti per corpi estranei, Marcatori, Pinza per capsula



DIX
43542-12



DIX
43544-12



DIX
43546-13



DIX
43548-13



CASTROVIEJO
43583-07 0-20 mm
7 cm, 2 3/4"



CONNIN-AMSLER
43589-13



HOLTH
43593-09

Tränenkanaldilatatoren, Sonden
 Lachrymal Dilators-, Probes
 Diladores, Estiletos para canal lacrimal
 Dilatori e Specilli per canale lacrimale



WILDER
43602-01



WILDER
43602-02



WILDER
43602-03

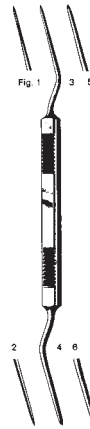
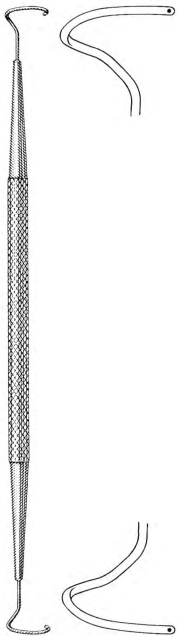

Fig. ZIEGLER
1/2 43605-12
3/4 43605-34
5/6 43605-56



CASTROVIEJO
43608-12



WORST
43609-14
14,9 cm 5 7/8"

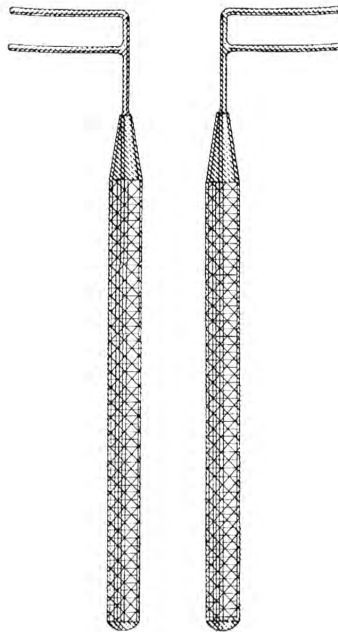

HARMS
43610-01 43610-02
4,8 cm 1 7/8"

geknüpft



rostfrei
stainless steel
acero inoxidable
acciaio inossidabile

Fig.	BOWMAN	Ø mm
0000/000	43613-00	0,6/0,7
00/0	43614-00	0,7/0,8
0/1	43614-01	0,8/0,9
1/2	43614-12	0,9/1,1
2/3	43614-23	1,1/1,3
3/4	43614-34	1,3/1,4
4/5	43614-45	1,4/1,5
5/6	43614-56	1,5/1,6
6/7	43614-67	1,6/1,8
7/8	43614-78	1,8/1,9

Iris Pinzetten
 Iris Forceps
 Pinzas para iris
 Pinze per iride



GRAEFE
 43802-07
 7 cm (2 3/4")/1 mm

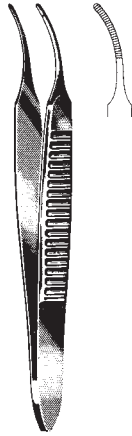

GRAEFE
 43803-07
 7 cm (2 3/4")/1 mm

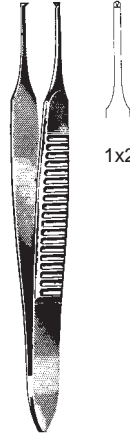

GRAEFE
 43804-07
 7 cm (2 3/4")/1 mm

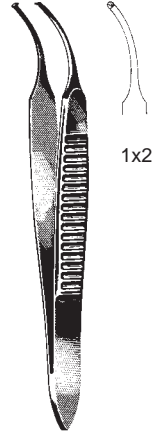

GRAEFE
 43805-07
 7 cm (2 3/4")/1 mm



GRAEFE
 43810-10
 10 cm
 4"



GRAEFE
 43811-10
 10 cm
 4"



GRAEFE
 43813-10
 10 cm
 4"

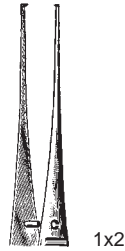

GRAEFE
 43820-10
 10 cm
 4"

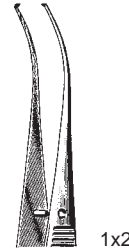

GRAEFE
 43821-10
 10 cm
 4"

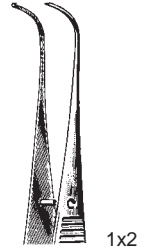

GRAEFE
 43823-10
 10 cm
 4"

Iris Pinzetten
 Iris Forceps
 Pinzas para iris
 Pinze per iride



STEVENS
 43830-10
 10,5 cm, 4.1"



STEVENS
 43831-10
 10,5 cm
 4.1"

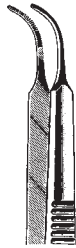

STEVENS
 43833-10
 10,5 cm
 4.1"



STEVENS
 43840-10
 10,5 cm
 4.1"



STEVENS
 43841-10
 10,5 cm
 4.1"



STEVENS
 43843-10
 10,5 cm
 4.1"

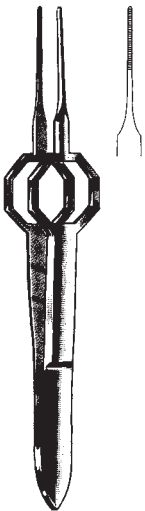

FOERSTER
 43850-08
 8,5 cm, 3.4"

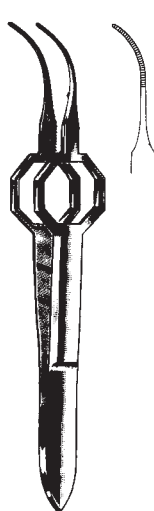

FOERSTER
 43851-08
 8,5 cm, 3.4"

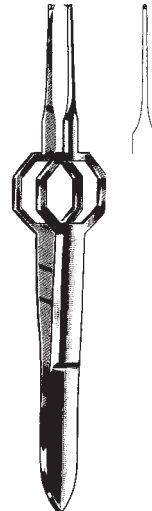

FOERSTER
 43852-08
 8,5 cm, 3.4"

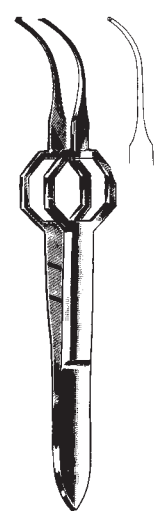

FOERSTER
 43853-08
 8,5 cm, 3.4"

Iris Pinzetten
Iris Forceps
Pinzas para iris
Pinze per iride

seitliche Zähne
lateral teeth
dientes laterales
denti laterali

Zähne abwärts
teeth below
dientes abajo
denti in basso

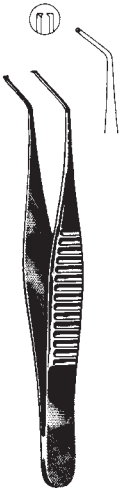

HESS
43855-07
7 cm (2 3/4")/
0,3 mm

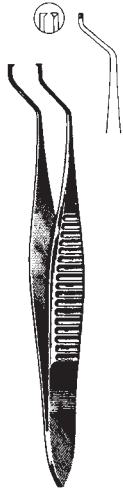

HESS
43857-07
7 cm (2 3/4")/
0,3 mm



GILL
43861-07
7,5 cm (3")/
0,3 mm



GILL-HESS
43863-07
7,5 cm (3")/
0,3 mm



GILL-HESS
43865-07
7,5 cm (3")/
0,3 mm

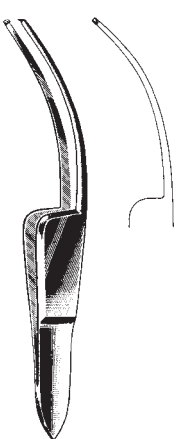

FISCHER
43869-07
7 cm (2 3/4")



BARRAQUER-KATZIN
43881-07
7 cm (2 3/4")/0,4 mm



TROUTMAN (Colibri)
43883-07
7 cm (2 3/4")/0,12 mm



BARRAQUER (Colibri)
43885-07
7 cm (2 3/4")/0,12 mm

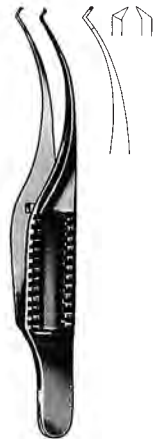

BARRAQUER (Colibri)
43887-07
7 cm (2 3/4")/0,12 mm

Fixierpinzette, Strabismus-Pinzetten
 Fixation forceps, Strabismus-Forceps
 Pinza para fijación, Pinzas para estrabismo
 Pinza per fissatrice, Pinze per strabismo



1x2

KIRBY-ARTHUR
 43891-09 9 cm, 3 1/2"
 0,2 mm



McCULLOUGH
 43902-09
 9,5 cm, 3 3/4"



McCULLOUGH
 43903-09
 9,5 cm, 3 3/4"

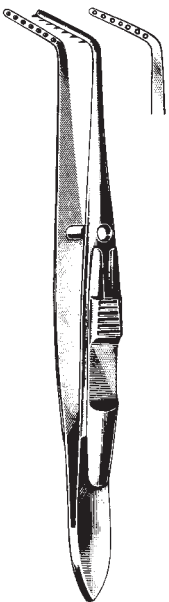

JAMESON
 43907-10
 L, 10 cm, 4"

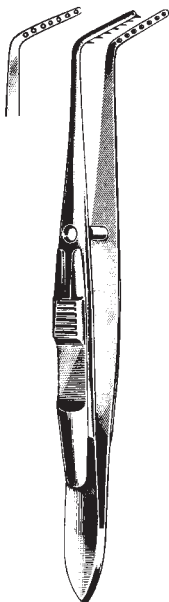

JAMESON
 43909-10
 R, 10 cm, 4"



BONACCOLTO
 43914-10
 10 cm, 4 1/1,7 mm



BONACCOLTO
 43916-10
 10 cm, 4 1/1,2 mm

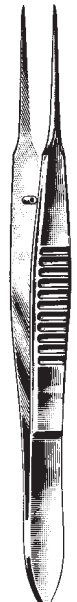

BONACCOLTO
 43920-11
 11 cm, 4 3/8"

Strabismus-Pinzetten, Iris Pinzetten
 Strabismus-Forceps, Iris Forceps
 Pinzas para estrabismo, Pinzas para iris
 Pinze per strabismo, Pinze per iride



DASTOOR
 43924-11
 11 cm, 4 ³/₈"

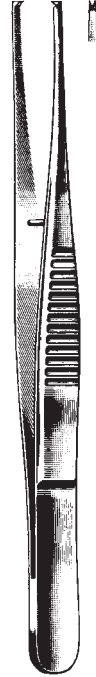

DASTOOR
 43926-11
 11 cm, 4 ³/₈"



BISHOP-HARMAN
 43940-05 8,5 cm, 3.4"
 0,5 mm



BISHOP-HARMAN
 43940-08 8,5 cm, 3.4"
 0,8 mm



1x2

BISHOP-HARMAN
 43942-05 8,5 cm, 3.4"
 0,5 mm



1x2

BISHOP-HARMAN
 43942-08 8,5 cm, 3.4"
 0,8 mm

Iris Pinzetten, Nahtpinzetten, Muskelpinzetten
 Iris, Suture forceps, Muscle Forceps
 Pinzas para iris, Pinza para sutura, Pinzas musculares
 Pinze per iride, Pinza per sutura, muscolari

mit Führungsstift
 with guide pin
 con perno guida
 con perno di guida

ohne Führungsstift
 without guide pin
 sin perno guida
 senza perno di guida



MOD. BONN
 43944-07
 7 cm, 2 3/4"
 0,12 mm

MOD. BONN
 43946-07
 7 cm, 2 3/4"
 0,12 mm

MOD. BONN
 43948-10
 10 cm, 4"
 0,12 mm

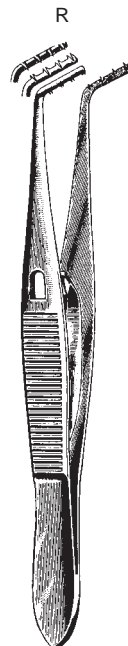
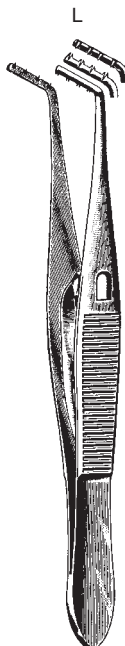

MOD. TÜBINGEN
 43950-10
 10 cm, 4"

MOD. BONN
 43952-10
 10 cm, 4"/0,12 mm

MOD. TÜBINGEN
 43953-10
 10 cm, 4"

PRINCE
 43955-10
 10 cm, 4"

PRINCE
 43956-10
 10 cm, 4"



Muskelpinzetten, Fixationspinzetten
 Muscule Forceps, Fixation Forceps
 Pinzas musculares, Pinzas para fijación
 Pinze muscolari, Pinze per fissaggio

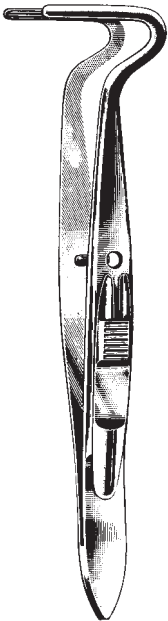

BERKE
 44015-20 - 44015-27
 10 cm, 4"

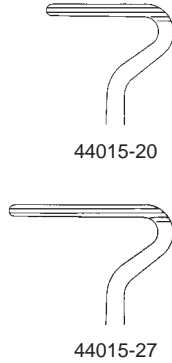

1x2
TROUTMAN
 44017-08 8,5 cm, 3.4"
 0,8 mm



ELSCHNIG
 44046-11
 11 cm, 4 3/8"



GRAEFE
 44050-11 - 44052-11
 11 cm, 4 3/8"



44050-11



44052-11
 mit Sperre
 with catch
 con cierre
 c. cremagliera



LESTER
 44054-09
 9 cm, 3 1/2"

Fixierpinzetten, Kapselpinzette
 Fixation forceps, capsular forceps
 Pinzas para fijación, Pinzas capsulares
 Pinze fissatrici, Pinze per capsulari



1x1

CASTROVIEJO
 44066-09
 9 cm, 3 1/2"



1x1

CASTROVIEJO
 44067-09
 9 cm, 3 1/2"



2x2

CASTROVIEJO
 44068-09
 9 cm, 3 1/2"

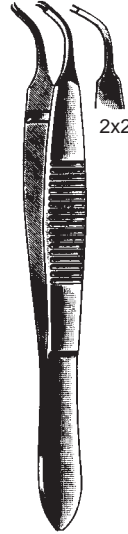

2x2

CASTROVIEJO
 44069-09
 9 cm, 3 1/2"



BARRAQUER
 44074-10
 10 cm, 4"

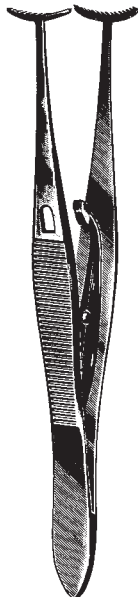

GREEN
 44076-05 - 44078-10
 10 cm, 4"



44076-05 5 mm 44076-10 10 mm

ohne Sperre
 without catch
 sin cierre
 senza cremagliera



44078-05 5 mm 44078-10 10 mm

mit Sperre
 with catch
 con cierre
 con cremagliera



GILL-ARRUGA
 44101-07
 7,5 cm, 3"

Kapselpinzetten
 Capsular Forceps
 Pinzas capsulares
 Pinze capsulare



TERSON
 44103-09
 9 cm, 3 1/2"



KALT
 44106-10
 10 cm, 4"



ELSCHNIG
 44109-10
 10 cm, 4"



ARRUGA
 44111-10
 10 cm, 4"



ARRUGA
 44114-10
 10 cm, 4"



CASTROVIEJO
 44115-10
 10 cm, 4"



SCHWEIGGER
 44117-10
 10 cm, 4"



SCHWEIGGER
 44119-10
 10 cm, 4"



ELSCHNIG
 44121-10
 10 cm, 4"



HESS
 44125-06
 6 cm, 2.4"

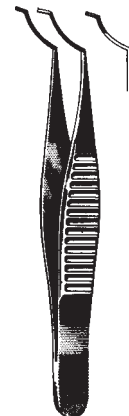

HESS
 44127-06
 6,5 cm, 2.6"

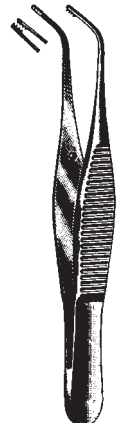

FUCHS
 44129-07
 7 cm, 2 3/4"

Nahtpinzetten, Fadenpinzetten
Suture Forceps, Tying Forceps
Pinzas para suturas y hilo
Pinze per sutura, Pinze per filo



CASTROVIEJO

10 cm, 4"

44150-01 0,12 mm
44150-03 0,30 mm
44150-05 0,50 mm
44150-10 1,00 mm
44150-15 1,50 mm

Zahn
tooth
diente
dente



CASTROVIEJO

10 cm, 4"

44151-05
44151-10
44151-15



MOORFIELD

44164-10
10 cm, 4"

St. MARTIN

44166-07
7 cm, 2 3/4"

Mod. TÜBINGEN

44181-10
10 cm, 4"

PAUFIGUE

44190-08
8,5 cm, 3.4"

PAUFIGUE

44202-08
8,5 cm, 3.4"

1x2



McPHERSON

44210-10
10 cm, 4"

McPHERSON

44220-10
10 cm, 4"

Pinzetten für Chalazion und Trachom
 Forceps for Chalazion and Trachoma
 Pinzas de chalazión y para tracoma
 Pinze per calazio e per trichiasi



AYER
 44240-09
 9 cm, 3 1/2"

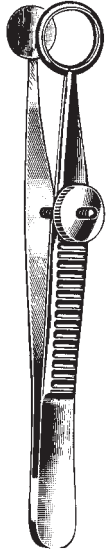

AYER
 44242-09
 9 cm, 3 1/2"

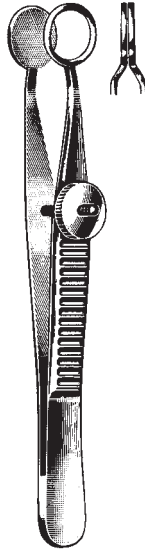

LAMBERT
 44246-09
 9 cm, 3 1/2"

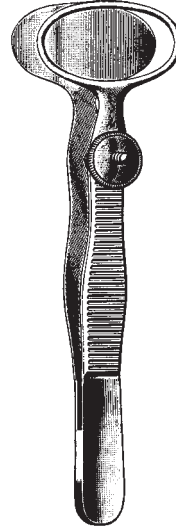

DESMARRES
 44254-09 - 44258-09
 9 cm, 3 1/2"



44254-09 20 mm
 Fig. 1

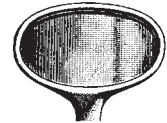

44256-09 24 mm
 Fig. 2

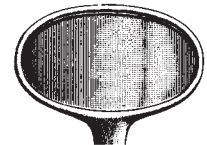

44258-09 32 mm
 Fig. 3

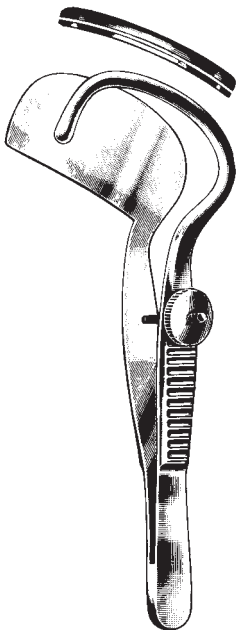

SNELLEN
 44265-10 10 cm, 4"

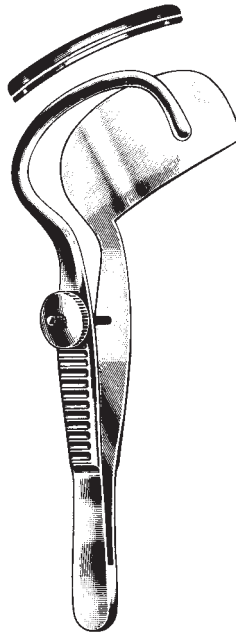

SNELLEN
 44267-10 10 cm, 4"

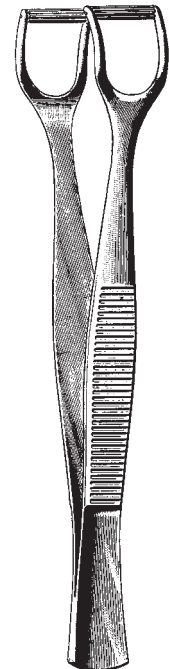

KNAPP-LUER
 44274-11 11 cm, 4 3/8"

Augenkanülen
 Eye Cannulas
 Cánulas oculares
 Cannule oculistiche

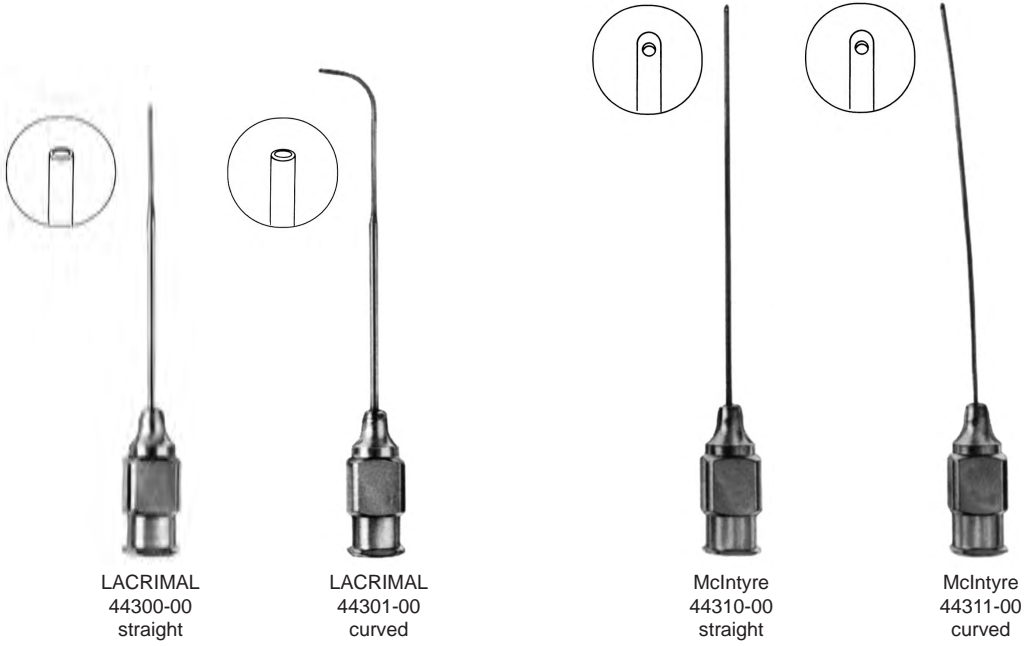

LACRIMAL
 44300-00
 straight

LACRIMAL
 44301-00
 curved

McIntyre
 44310-00
 straight

McIntyre
 44311-00
 curved

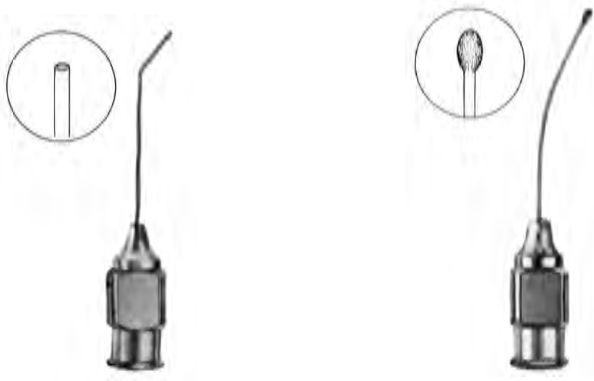

Air Injection
 44320-00 27 gauge
 44330-00 30 gauge

JENSEN
 44340-00 23 gauge
 44350-00 25 gauge

Spül- und Saugkanülen, Augenkanülen
Irrigation and Aspiration Cannulas, Eye Cannulas
Cánulas de irrigación y aspiración, Cánulas oculares
Cannule per irrigazione ed aspirazione, Cannule oculistiche

**BISHOP-HARMON**

44370-00	complete
44371-00	silicone bulb
44372-00	adaptor
44373-00	19 gauge cannula
44374-00	21 gauge cannula

Augenkanülen, Tonometer
 Eye Cannulas, Tonometer
 Cánulas oculares, Tonómetro
 Cannule oculistiche, Tonometro



SHEETS
44380-00



SIMCOE
44390-00



	SCHIOETZ	
	44404-00	44406-00
Skala	gerade	schräg
scale	straight	oblique
escala	recta	oblícua
scala	retta	obliqua

Augenmagnet, Cilienpinzetten
Eye Magnet, Cilia Forceps
Imàn para cuerpos extraños, Pinzas depilatorias
Calamita per corpi estranei, Pinze depilatorie



REDA
44408-00



BEER
44420-09
9 cm, 3 1/2"

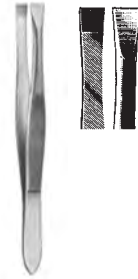

DOUGLAS
44422-09
9 cm, 3 1/2"



LITTAUER
44424-08
8,5 cm, 3.4"



BARRAQUER
44425-10
10,5 cm, 4.1"



REDA
44426-09
9 cm, 3 1/2"



GRADLE
44428-09
9,5 cm, 3 3/4"





Ohrspekula
Ear Specula
Espéculos auriculares
Specoli auricolari



POLITZER
45009-00
Set = 3

Innen Ø
○ = 2 mm
45009-02

○ = 3 mm
45009-03

○ = 4 mm
45009-04



HARTMANN
45010-00
Set = 4

Innen Ø
○ = 2 mm
45010-20

○ = 3 mm
45010-30

○ = 4,5 mm
45010-45

○ = 5,5 mm
45010-55

○ = 6,5 mm
45010-65

○ = 7,5 mm
45010-75



HARTMANN
45011-00
Set 3-7 mm

schwarz
black
negro
nero

Innen Ø
○ = 3 mm
45011-03

○ = 4 mm
45011-04

○ = 5 mm
45011-05

○ = 7 mm
45011-07

○ = 8 mm
45011-08



TOYNBEE
45012-00
Set = 3

Innen Ø
○ = 4 mm
45012-40

○ = 5,5 mm
45012-55

○ = 6,5 mm
45012-65

○ = 7,5 mm
45012-75



GRUBER, rund
45014-00
Set = 4

Innen Ø
○ = 4,5 mm
45014-45

○ = 5,5 mm
45014-55

○ = 6,5 mm
45014-65

○ = 7,5 mm
45014-75



GRUBER, oval
45015-00
Set = 4

Innen Ø
○ = 4,5 mm
45015-45

○ = 5,5 mm
45015-55

○ = 6,5 mm
45015-65

○ = 7,5 mm
45015-75

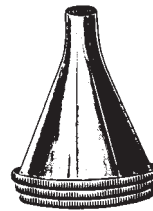

BOUCHERON
45018-00
Set = 4

Innen Ø
○ = 5 mm
45018-50

○ = 6 mm
45018-60

○ = 7 mm
45018-70

○ = 8 mm
45018-80

Ohrspekula
Ear Specula
Espéculos auriculares
Specoli auricolari

○
45020-01
Ø 3 mm

○
45020-02
Ø 4 mm

○
45020-03
Ø 5 mm

○
45020-04
Ø 6 mm

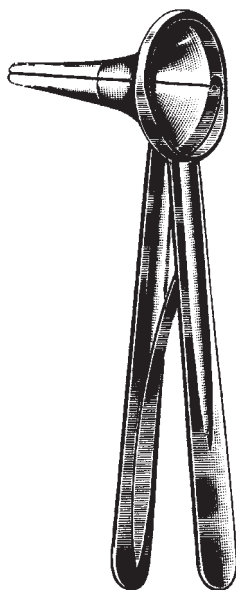

RICHNAU-HOLMGREN

Ohrspekula
Ear Specula
Espéculos auriculares
Specoli auricolari

6,5 mm



45030-06

7,5 mm



45030-07

8,2 mm



45030-08

10 mm



45030-10

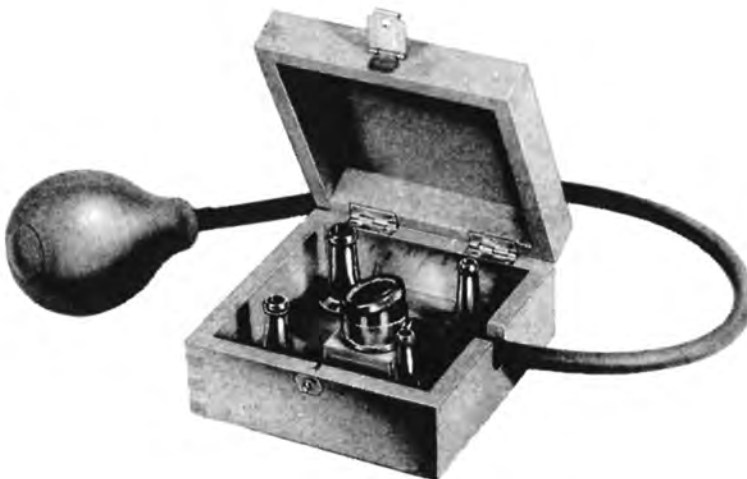

BRUENINGS
45030-04
compl.

Komplett bestehend aus:
4 Spekula, Saugkammer mit
Gebläse, Holzetui

Complete consisting of:
4 specula, suction head and rubber
tube with bulb, wooden case

Compuesto de:
4 espéculos, cámara de aspiración,
insuflador de goma, en estuche de
madera

Composta da:
4 specoli, camera aspirante con
soffiatrice, scatola di legno

Ersatzteile / spare parts /
repuestos / pezzi di ricambio

45036-09

Lupe / Magnification glass /
lupa / lente d'ingrandimento

45036-10

Saugpumpe / rubber ball /
pera de goma / soffiatrice di gomma

Ohrspekula
Ear Specula
Espéculos auriculares
Specoli auricolari



6,5 mm Ø



45036-06



7 mm Ø



45036-07



8 mm Ø



45036-08

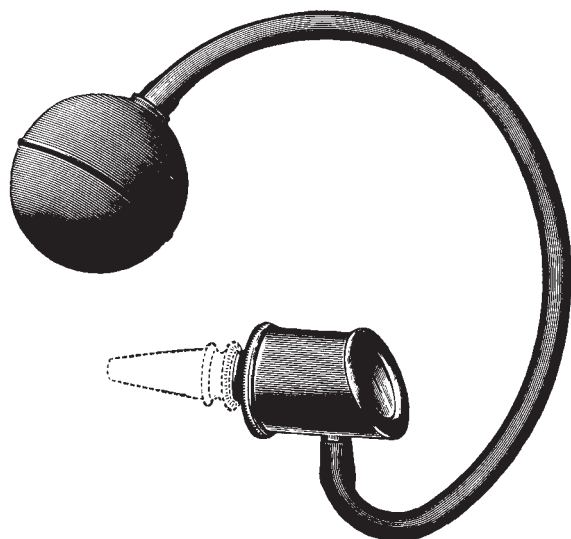

SIEGLE
45036-03
compl.

Komplett bestehend aus:
Ohrspekulum, 3 Spekula, 1 Gebläse

Complete consisting of:
Ear Specula, 1 rubber tube with bulb

Compuesto de:
Otoscopio con 3 espéculos, insuflador y tubo

Composta da:
Otoscopio con 3 specoli e 1 insufflatore con tubo

Stimmungsgabeln
Tuning Forks
Diapasones
Diapason

ALU

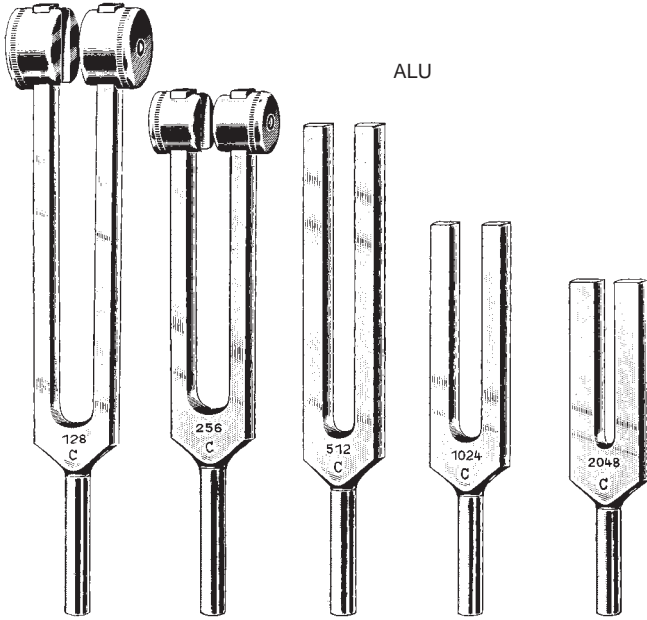

45060-01
C 128

45060-02
C' 256

45060-03
C² 512

45060-04
C³ 1024

45060-05
C⁴ 2048

45061-00
compl.

STAINLESS

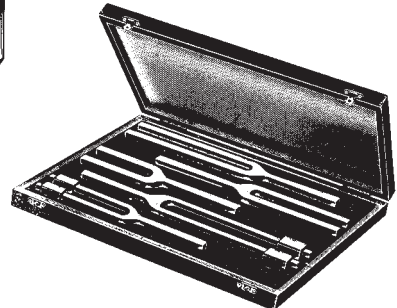
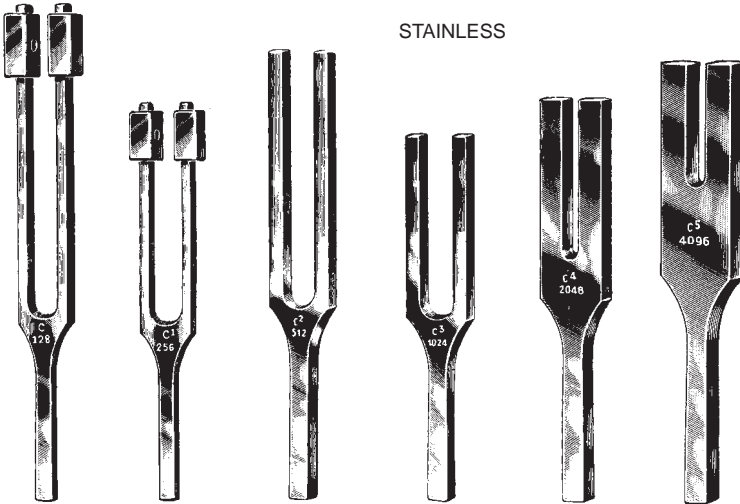

45070-01
C 128

45070-02
C' 256

45070-03
C² 512

45070-04
C³ 1024

45070-05
C⁴ 2048

45070-06
C⁵ 4096

HARTMANN
45071-00
compl.

Stimmgabeln
Tuning Forks
Diapasones
Diapason



45072-01
a¹ 440



LUCAE
45073-01 C 128
45073-02 C¹ 256
45073-03 C² 512
45073-04 C³ 1024
45073-05 C⁴ 2048
45073-06 C⁵ 4096



LUCAE
45074-01
C 128



45075-00

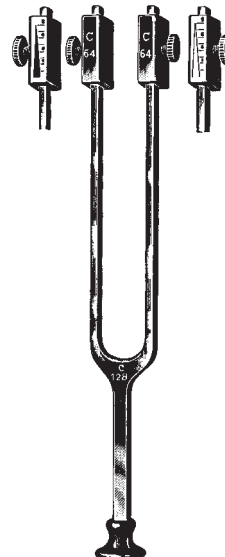

RYDEL-SEIFFERT
45076-01 C 128 / C 64

Lärmtrommel, Pulverbläser
 Noise Apparatus, Powder Blowers
 Ensordecedor, Lanzapolvero
 Assorditore, Insoffiatori per polvere



BARANY
45080-00

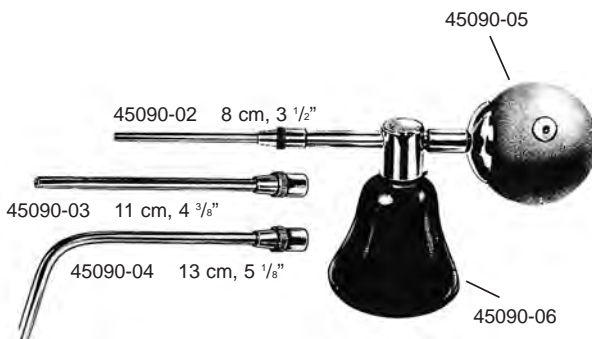

KABIERSKE
45090-00 compl.
30 cc

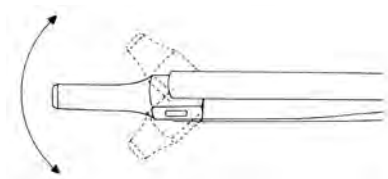

Universal
45090-08

Komplett mit beweglicher Düse,
 Schraubflasche 30 ccm und Halbgebläse
 complete with movable tube, screw bottle
 30 ccm and rubber bulb
 completo con tubo móvil botella con rosca
 30 ccm y pera de goma
 completo con tubo mobile, bottiglia con
 filettatura 30 ccm e pera di insufflazione



Luftdusche, Ohrspritze
 Air Bag, Ear Syringe
 Insuflador de aire, Jeringa
 Insoffiatore d'aria, Siringa Auricolare



45091-02
 Gummibirne alleine
 Rubber bulb only
 Pera de goma, sola
 Pera di gomma, sola

POLITZER
 45091-00 Set
 incl.
 45091-03
 45091-15
 45091-17
 45091-22

POLITZER
 45091-01 Set
 incl.
 45091-03
 45091-04
 45091-15
 45091-17
 45091-22



45091-03

45091-04
4 mm Ø45091-15
15 mm Ø45091-17
17 mm Ø45091-22
22 mm Ø

ml REINER
 compl.
 50 45096-50
 75 45096-75
 100 45097-10
 150 45097-15



45097-01



45097-02



45097-03

Spritze, Küretten
 Syringe, Curettes
 Jeringa, Curetas
 Siringa, Curette



45098-01 1 ml
 45098-02 2 ml
 45098-05 5 ml
 45098-10 10 ml
 45098-20 20 ml
 45098-50 50 ml

45099-01 1 ml
 45099-02 2 ml
 45099-05 5 ml
 45099-10 10 ml
 45099-20 20 ml
 45099-50 50 ml



Küretten
 Curettes
 Curetas
 Curette



Fig. 00 0 1 2 3 4 5

stumpf
 blunt
 romas
 smusse



45109-00 45110-00 45110-01 45110-02 45110-03 45110-04 45110-05

scharf
 sharp
 cortantes
 taglianti



45111-00 45112-00 45112-01 45112-02 45112-03 45112-04 45112-05

stumpf
 blunt
 romas
 smusse



45114-00 45115-00 45115-01 45115-02 45115-03 45115-04 45115-05

scharf
 sharp
 cortantes
 taglianti



45116-00 45117-00 45117-01 45117-02 45117-03 45117-04 45117-05

BUCK
 14,5 cm, 5 3/4"

Ohrkatheter, Parazentese Nadeln, Ohrmesser
 Catheters, Paracentesis Needles, Ear Knives
 Cateteres, agujas para paracentesis, Cuchillos auriculares
 Cateteri, Aghi per paracentesi, Coltelli auricolari

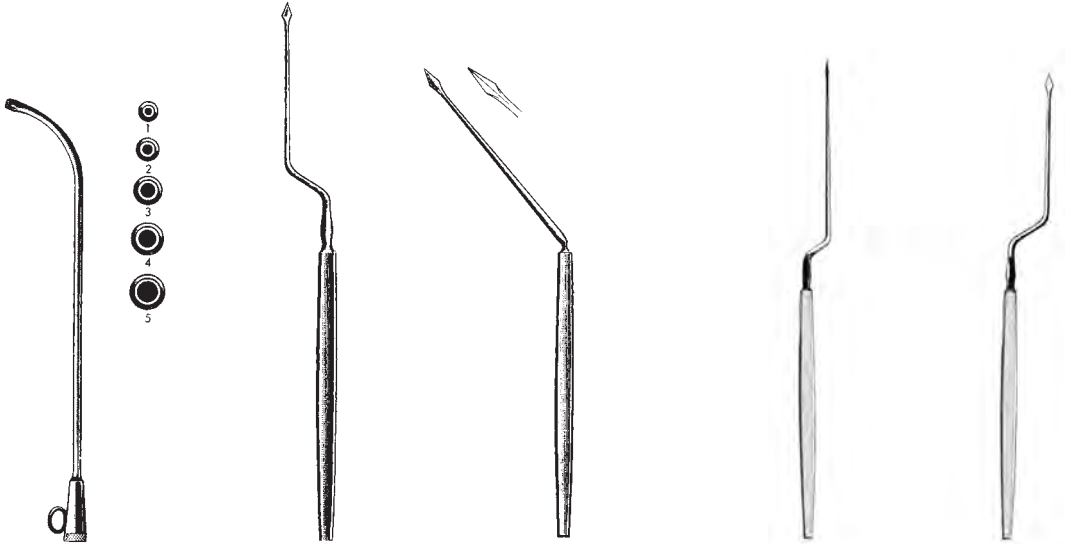

Fig. HARTMANN

- | | | |
|---|----------|--------|
| 1 | 45133-01 | 3,5 mm |
| 2 | 45133-02 | 4,0 mm |
| 3 | 45133-03 | 4,5 mm |
| 4 | 45133-04 | 5,0 mm |
| 5 | 45133-05 | 6,0 mm |

POLITZER
45150-18
18 cm, 7"

POLITZER
45151-16
16,5 cm, 6 1/2"

LUCAE
45152-01
18 cm, 7"

LUCAE
45152-02
18 cm, 7"

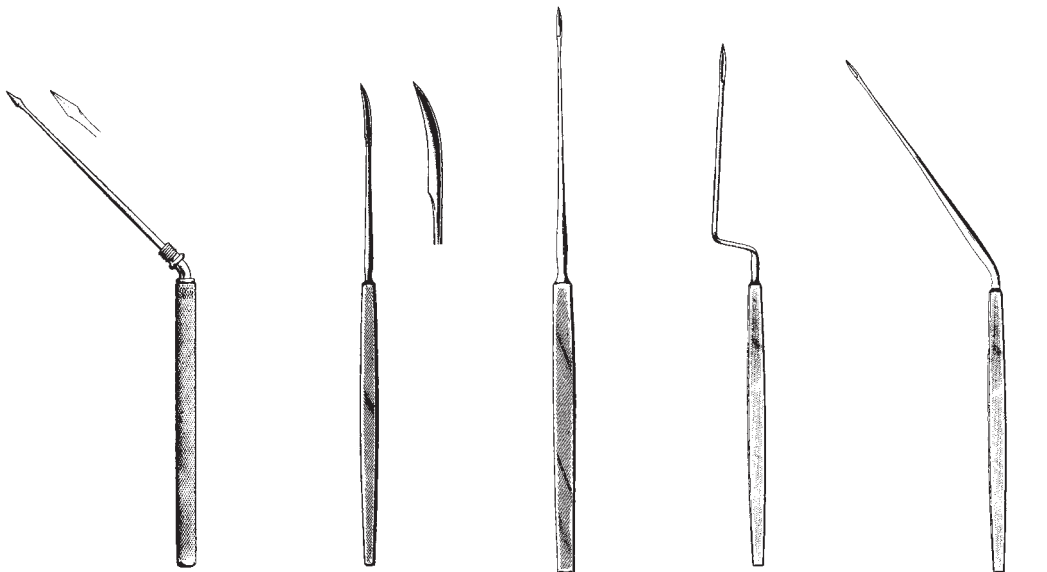

POLITZER
45153-16
16 cm, 6 1/4"

POLITZER
45160-15
15 cm, 6"

SEXTON
45162-18
18 cm, 7"

SEXTON
45164-17
17 cm, 6 3/4"

SEXTON
45165-17
17 cm, 6 3/4"

Löffel, Schlingen, Haken
 Ear spoons, Loops, Hooklets
 Cucharas, Asas, Ganchitos
 Cucchiai, Anse, Uncinetti



GROSS
 45171-12
 12 cm, 4 3/4"



BILLEAU
 45180-01 - 45180-03
 16 cm, 6 1/4"



45180-01



45180-02



45180-03



LANGENBECK
 45181-13
 13 cm, 5 1/8"



ZAUFAL
 45184-16
 16 cm, 6 1/4"

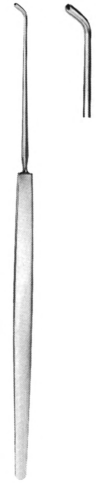

ZAUFAL-JANSEN
 45185-15
 15 cm, 6"



DAY
 45190-01 - 45190-02
 16 cm, 6 1/4"



45190-01



45190-02



WAGENER
 45192-01 - 45192-04
 14 cm, 5 1/2"



45192-01



45192-03



45192-02



45192-04



45192-05



45192-06



LUCAE
 14 cm, 5 1/2"



45193-01
 2 mm



45193-02
 3 mm



45193-03
 4 mm

Schlingen, Pinzetten
 Loops, Dressing Forceps
 Asas, Pinzas
 Anse, Pinze

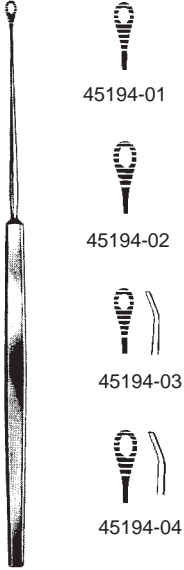

SHAPLEIGH
 45194-01 - 45194-04
 13 cm, 5 1/8"



WILDE (TROELTSCH)



LUCAE
 45206-14
 14 cm, 5 1/2"



LUCAE
 45206-16
 16 cm, 6 1/4"



COTTLE
 45208-14
 14 cm, 5 1/2"

Polypenschnürer, Ohrzängchen
Snares, Ear Forceps
Cierra-nudos, Pinzas auriculares
Serranodi, Pinze auricolari



KRAUSE
45220-16
16 cm, 6 1/4"

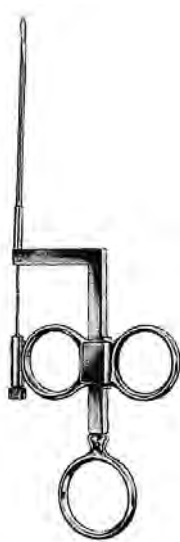

WILDE
45222-17
17 cm, 6 3/4"



45225-02
doz./doc./dozz.
0,2 mm

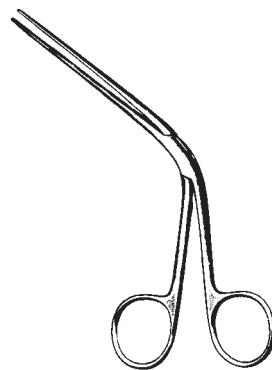

TILLEY
45243-14
14 cm, 5 1/2"



LITTAUER
45245-12
12 cm, 4 3/4"

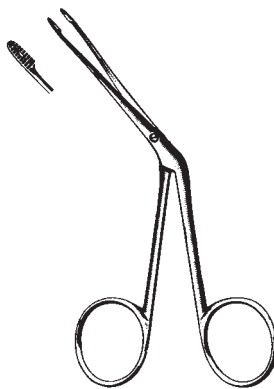

HARTMANN
45246-12
12 cm, 4 3/4"

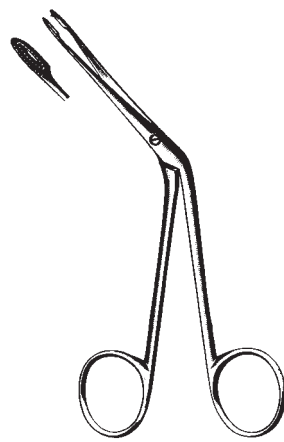

HARTMANN
45246-14
14 cm, 5 1/2"

Fremdkörperheber, Fremdkörperzängchen
 Foreign Body Levers, Ear Polypus Forceps
 Elevadores para cuerpos extraños, Pinzas para pólipos
 Leve per corpi estranei, Pinze per polipi



QUIRE
 45251-10
 10 cm, 4"

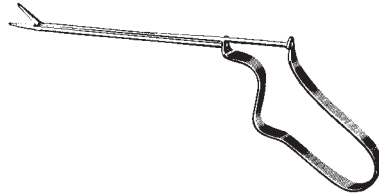

BUCK
 45253-11
 11 cm, 4 3/8"

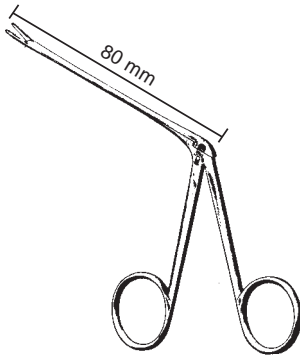

45255-08 - 45275-08



HARTMANN-WULLSTEIN
 45255-08
 8,5 cm, 3.4"



HARTMANN-WULLSTEIN
 1 mm 45257-08
 8,5 cm, 3.4"



HARTMANN
 45261-08 8,5 cm, 3.4"
 45261-14 14,0 cm, 5 1/2"
 45261-16 16,0 cm, 6 1/4"



HARTMANN
 45263-08 8,5 cm, 3.4"
 45263-14 14,0 cm, 5 1/2"



HARTMANN
 45265-08
 8,5 cm, 3.4"



Ø mm HARTMANN
 2,0 45267-20 8,5 cm, 3.4"
 2,5 45267-25 8,5 cm, 3.4"
 3,0 45267-30 8,5 cm, 3.4"

○ 3 mm Ø



HARTMANN
 45269-30
 8,5 cm, 3.4"



STRUEMPEL
 45271-08 8,5 cm, 3.4"
 2,5x5 mm



HARTMANN
 45273-08
 8,5 cm, 3.4"

○ 2 mm Ø



HARTMANN-HOFFMANN
 45275-08
 8,5 cm, 3.4"

Micro-Ohrscheren, Micro-Ohrzangchen
 Micro Ear Scissors, Micro Ear Forceps
 Tijeras auriculares micro, Pinzas auriculares micro
 Forbici auricolari micro, Pinze auricolari micro

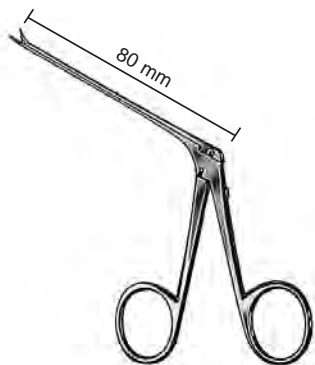

45310-40 - 45322-70



A
 BELLUCCI
 45310-40
 micro mini
 4 mm



A
 BELLUCCI
 45312-55
 micro standard
 5,5 mm



D
 BELLUCCI
 45313-55
 micro standard
 5,5 mm



B
 BELLUCCI
 45315-55
 micro standard
 5,5 mm

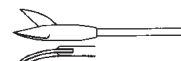

C
 BELLUCCI
 45317-55
 micro standard
 5,5 mm



A
 SHEA
 45320-70
 7,0 mm



C
 SHEA
 45321-70
 7,0 mm

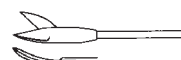

B
 SHEA
 45322-70
 7,0 mm

- A:** gerade / straight / recta / retta
- B:** rechts / right / derecha / destra
- C:** links / left / izquierda / sinistra
- D:** aufgebogen / curved up / curva in alto / curva hacia arriba
- E:** nach unten gebogen / curved down / curva in basso / curva hacia abajo

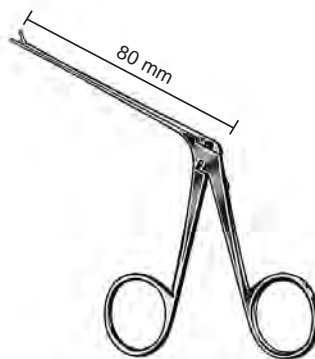

45350-40 - 45360-35



A
 45350-40
 4 mm



A
 45350-70
 7 mm



A
 45352-40
 4 mm



C
 45353-60
 6 mm

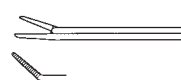

B
 45355-60
 6 mm



D
 45357-40
 4 mm



E
 45359-40
 4 mm

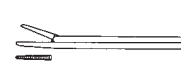

A
 45360-35
 3,5 mm

Micro-Ohrzängchen
Micro Ear Forceps
Pinzas auriculares micro
Pinze auricolari micro

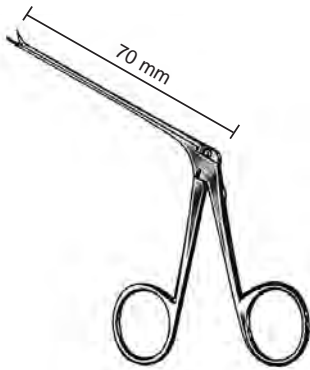

45362-45 - 45383-30



A
45362-45
4,5 mm



C
45363-45
4,5 mm



B
45365-45
4,5 mm

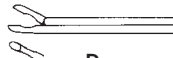

D
45367-50
5,0 mm

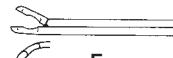

E
45369-50
5,0 mm

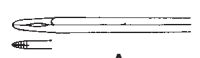

A
GREVEN
45370-50
5,0 mm

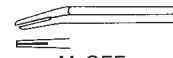

McGEE
45371-40
0,8x4,0 mm



COS
45373-30
1,8x0,8x3,0 mm



JUERS
45375-60
6,0 mm



JUERS
45377-60
6,0 mm



C
HAUGH
45381-30
45° 3 mm



B
HAUGH
45383-30
45° 3 mm

- A:** gerade / straight / recta / retta
B: rechts / right / derecha / destra
C: links / left / izquierda / sinistra
D: aufgebogen / curved up / curva in alto / curva hacia arriba
E: nach unten gebogen / curved down / curva in basso / curva hacia abajo

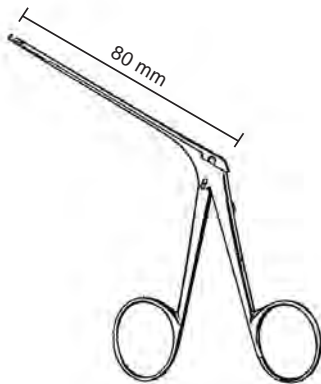

DIETER
45385-01 - 45387-02

micro ø 1,3 mm



45385-01

aufwärts
upward
arriba
in alto

mini ø 1,8 mm



45387-01

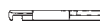

45385-02

abwärts
downward
abajo
in basso

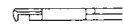

45387-02

Micro-Ohrzängchen
Micro Ear Forceps
Pinzas auriculares micro
Pinze auricolari micro



45390-35
0,8 x 3,5 mm

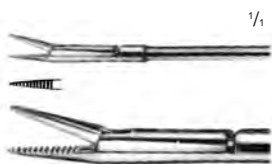

45390-50
1 x 5 mm



45391-35
0,8 x 3,5 mm



45392-35
0,8 x 3,5 mm



45393-50
1 x 5 mm



45394-50
1 x 5 mm

Micro-Ohrzängchen
 Micro Ear Forceps
 Pinzas auriculares micro
 Pinze auricolari micro



WULLSTEIN



45400-01
 0,9 x 1 mm



45400-02
 0,8 x 1,3 mm



45400-03
 1 mm



45401-25
 1,7 x 2,5 mm



45402-10
 0,9 x 1 mm



45403-13
 0,8 x 1,3 mm



45404-13
 0,8 x 1,3 mm

Micro-Ohrscheren
Micro Ear Scissors
Tijeras auriculares micro
Forbici auricolari micro



BELLUCCI



45410-01



45411-01



45412-01



45413-01



45414-01

Messer
Knives
Cuchillos
Coltelli



SCHUKNECHT
45701-01
16 cm, 6 1/4"



SCHUKNECHT
45701-02
16 cm, 6 1/4"



SCHUKNECHT
45703-15
15,5 cm, 6"



WULLSTEIN
45704-15
15,5 cm, 6"



TABB
45705-15
15,5 cm, 6"



PLESTER
45706-35
15,5 cm, 6"

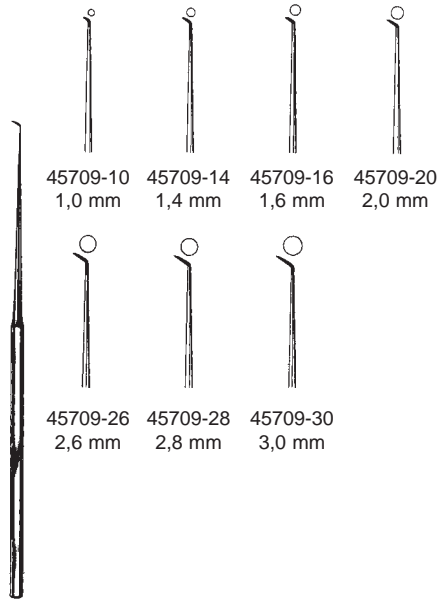

45709-10 1,0 mm
45709-14 1,4 mm
45709-16 1,6 mm
45709-20 2,0 mm

45709-26 2,6 mm
45709-28 2,8 mm
45709-30 3,0 mm

ROSEN
45709-10 - 45709-30
16 cm, 6 1/4"

Nadeln und Häkchen
 Needles and Hooks
 Aguja y Ganchos
 Aghi e uncini



16 cm
 6 1/4"

BARBARA
 45710-15



BARBARA
 45711-15



BARBARA
 45713-15



BARBARA
 45715-17



	25°	45°	90°	BARBARA
mm	SHAMBAUGH	SHAMBAUGH	SHAMBAUGH	45725-05=0,5 mm
0,3	45720-03	45722-03	45724-03	45725-10=1,0 mm
0,6	45720-06	45722-06	45724-06	
1,0	45720-10	45722-10	45724-10	
1,2		45722-12	45724-12	
1,5		45722-15	45724-15	
2,0		45722-20	45724-20	
2,5		45722-25	45724-25	



45730-03 - 45747-10
 15,5 cm, 6"

	90°	90°
mm	45730-03	45732-03
0,3	45730-06	45732-06
0,6	45730-10	45732-10
1,0		

	McGEE	McGEE
mm	45733-05	45735-05
0,5	45733-10	45735-10
1,0		

BARBARA
 45736-15
 15,5 cm, 6"

ROSEN

45737-15
 15,5 cm, 6"

	25°	25°	45°	45°
mm	45741-03	45743-03	45745-03	45747-03
0,3	45741-06	45743-06	45745-06	45747-06
0,6	45741-10	45743-10	45745-10	45747-10
1,0				

Dissektoren, Küretten, Elevatoren, Mikro-Meßsonde
 Dissectors, Curettes, Elevators, Micro measuring rod
 Disectores, Curetas, Elevadores, Sonda para mesurar
 Dissettori, Curette, Elevatori, Sonda auricolare per misurare

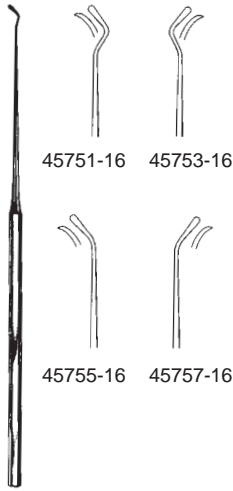

FISCH
 45751-16 - 45757-16
 16 cm, 6 1/4"

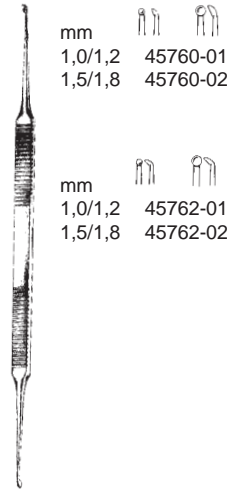

HOUSE
 45760-01 - 45762-02
 15 cm, 6"



LEMPERT
 45802-16 - 45805-16
 16 cm, 6 1/4"

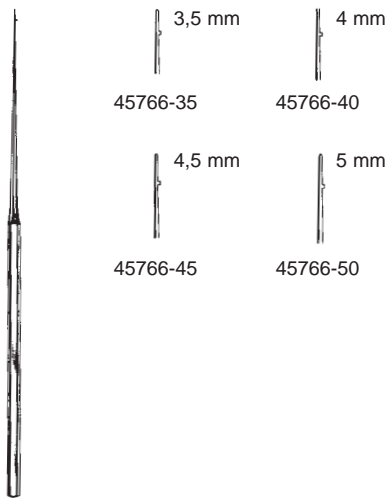

HOUSE
 45766-35 - 45766-50
 16 cm, 6 1/4"



LEMPERT
 45807-20
 20,5 cm, 8"

Nasenspekula
 Nasal Specula
 Espéculos nasales
 Specoli nasali



THUDICHUM
 47050-01 - 47050-07

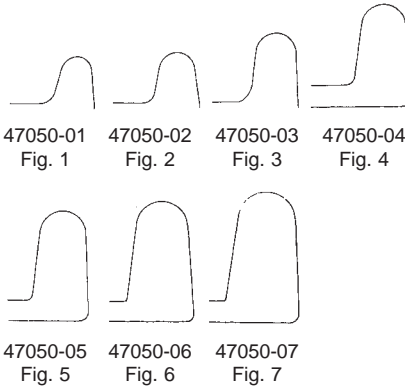

VOLTOLINI
 47060-01 - 47060-03

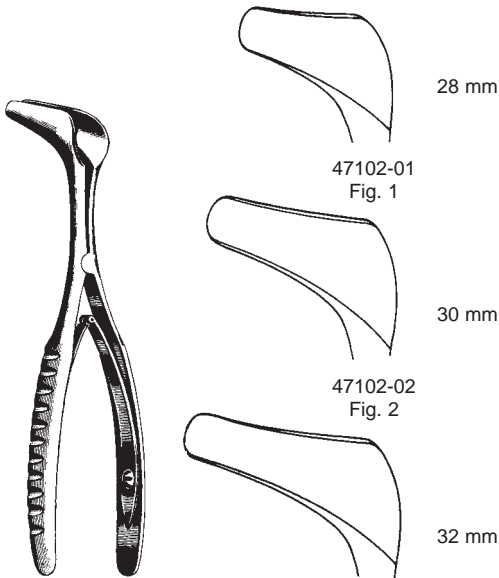

HARTMANN-HALLE
 47102-01 - 47102-03
 15 cm, 6"

Baby, bébé
 Kind, child, niño, bamb.
 Erwachs., Adult, adulto

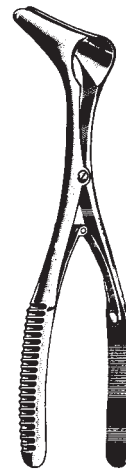

Mod. VIENNA
 47112-01 25 mm
 47112-02 30 mm
 47112-03 35 mm

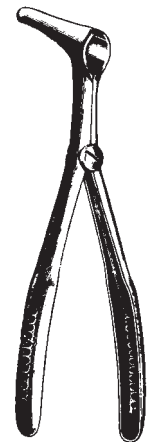

Mod. VIENNA
 47113-03

leichtes Modell
 lightweight
 mod. ligero
 mod. leggero

Nasenspekula
Nasal Specula
Espéculos nasales
Specoli nasali

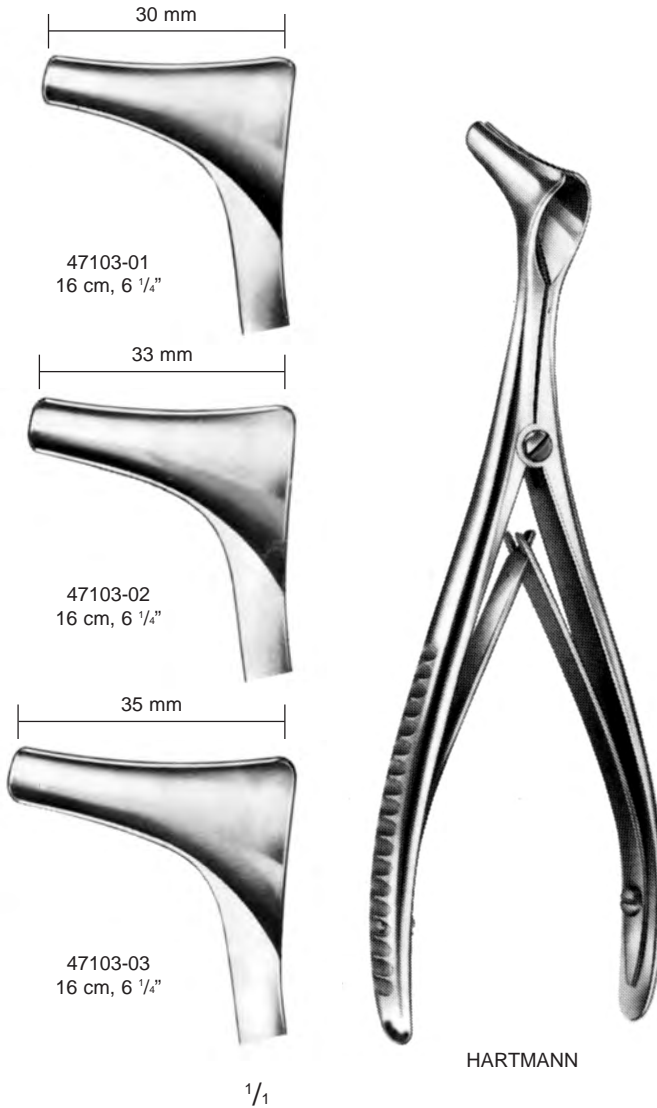

Nasenspekula, Kehlkopfspiegel
 Nasal Specula, Laryngeal Mirrors
 Espéculos nasales, espejos laríngeos
 Specoli nasali, Specchi laringei

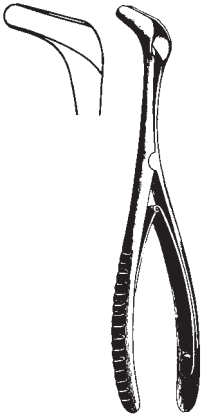

TIECK-HALLE
 47116-13
 13,5 cm, 5 1/4"



REDA
 47118-13
 12,5 cm, 5"



KILLIAN
 47120-35 - 47120-90
 13 cm, 5 1/8"



47120-35
 35 mm

47120-50
 50 mm

47120-75
 75 mm

47120-90
 90 mm



COTTLE
 47124-35 - 47124-90
 14 cm, 5 1/2"

47124-35 35 mm
 47124-50 50 mm
 47124-75 75 mm
 47124-90 90 mm

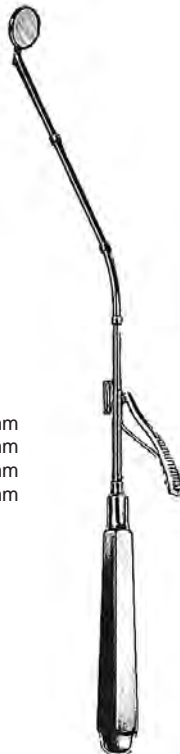

MICHEL
 47139-12 - 47139-18
 25 cm, 10"



47139-12
 12 mm



47139-14
 14 mm



47139-16
 16 mm



47139-18
 18 mm

Nasenpinzetten, Polypenzange
 Ear Dressing Forceps, Ear Polypus Forceps
 Pinzas auriculares, Pinzas para pólipos
 Pinze auricolari, Pinze per polipi



TROELTSCH
 47151-15
 15 cm, 6"

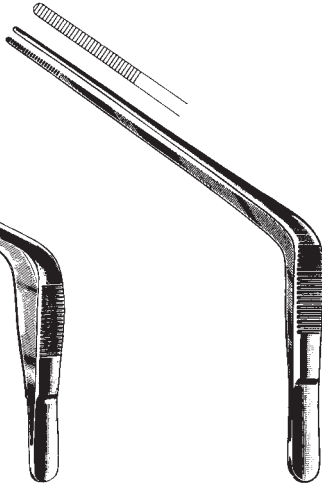

TROELTSCH
 47151-18
 18 cm, 7"



JANSEN-GRUENWALD
 47154-20
 20 cm, 8"



JANSEN
 47155-20
 20 cm, 8"

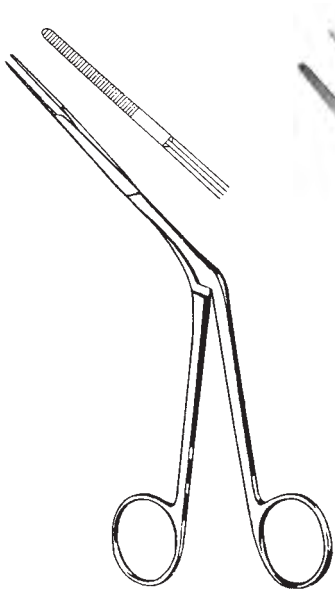

WESTMACOTT
 47158-20
 20 cm, 8"



LUBET-BARBON
 47159-20
 20 cm, 8"

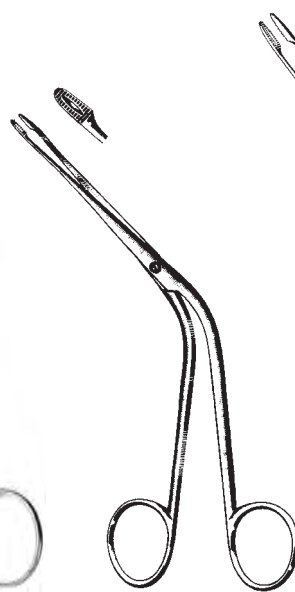

HARTMANN
 47161-16
 16 cm, 6 1/4"

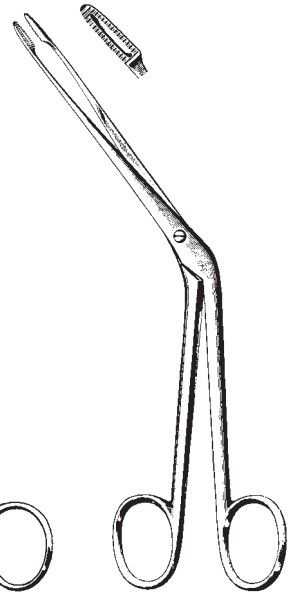

HARTMANN
 47161-20
 20 cm, 8"

Polypenzangen, Septumzangen
 Nasal Polypus and Septum Forceps
 Pinzas para pólipos y para el tabique nasal
 Pinze per polipi, Pinze per il setto nasale

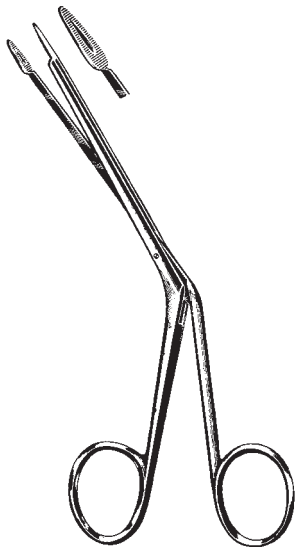

LITTAUER
 47167-18
 18 cm, 7"

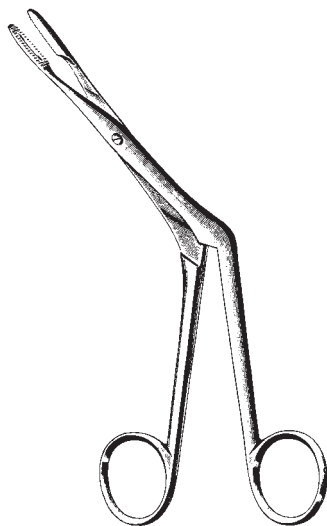

HEYMANN-KNIGHT
 47169-18
 18 cm, 7"

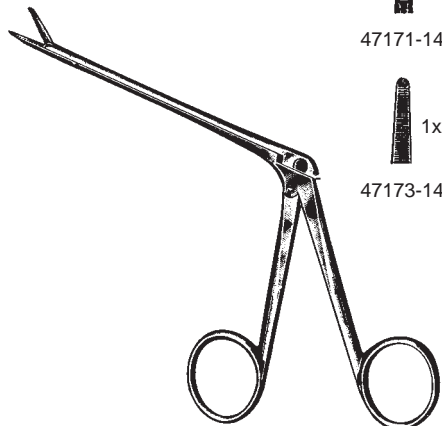

NOYES
 47171-14 - 47173-14
 14,5 cm, 5 3/4"

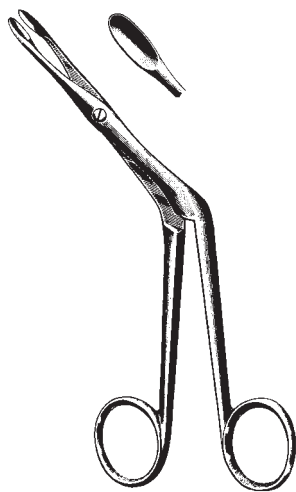

HEYMANN
 47181-18
 18 cm, 7"

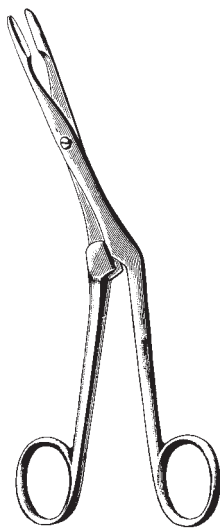

KNIGHT
 47185-18
 18 cm, 7"

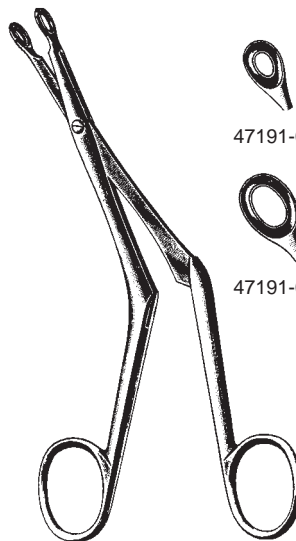

BRUENINGS
 47191-01 - 47191-04
 19 cm, 7 1/2"

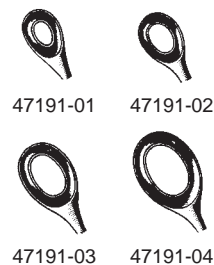

Scharfe Nasenzangen, Septumzangen
 Nasal Cutting Forceps, Septum Forceps
 Pinzas cortantes nasales y para el tabique nasal
 Pinze taglienti nasali, Pinze per il setto nasale



GRAIG
 47192-16
 16 cm, 6 1/4"

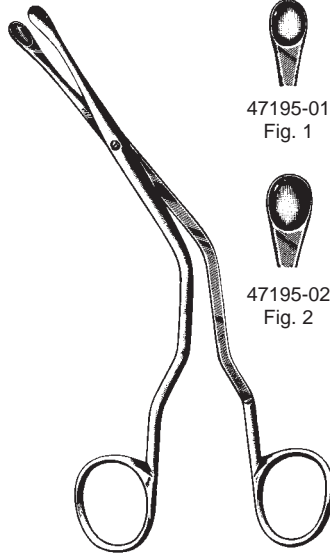

LUC
 47195-01 - 47195-05
 19 cm, 7 1/2"

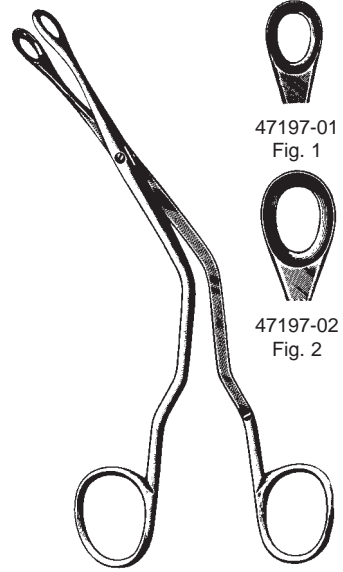

LUC
 47197-01 - 47197-02
 19 cm, 7 1/2"

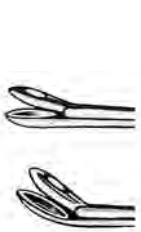
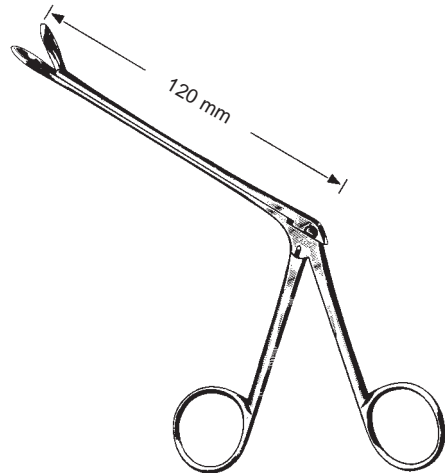

Fig. 1 47223-01	Fig. 2 47223-02
3,0 mm	3,6 mm
47224-01	47224-02

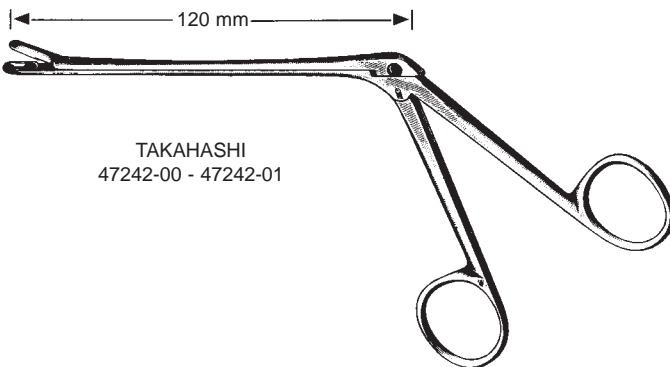
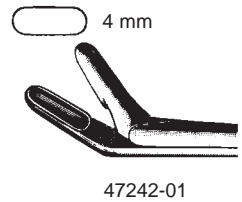
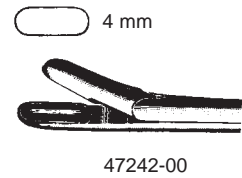
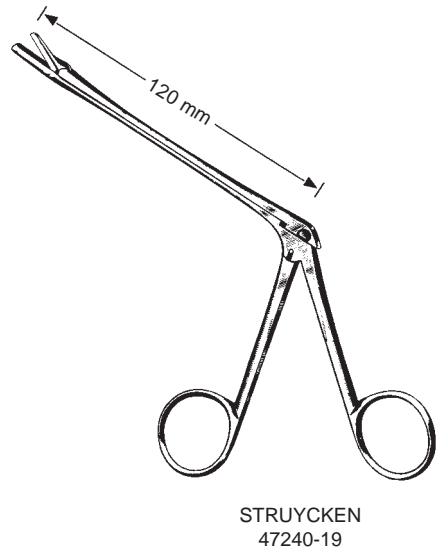
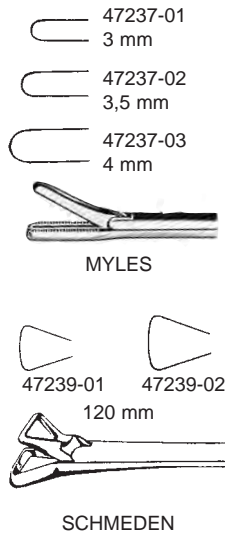
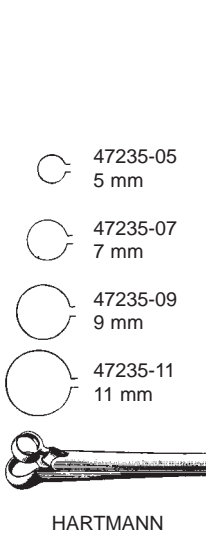

Fig. 3 47223-03	Fig. 4 47223-04	Fig. 5 47223-05
4,2 mm	4,8 mm	5,8 mm
47224-03	47224-04	47224-05



WEIL-BLAKESLEY
 47223-01 - 47224-05

Scharfe Nasenzangen
 Nasal Cutting Forceps
 Pinzas cortantes nasales
 Pinze taglianti nasali



Scharfe Nasenzangen, Septumzange, Kieferhöhlenstanze
 Nasal Cutting Forceps, Septum Forceps, Antrum Punch Forceps
 Pinzas cortantes nasales, Pinza para magullar tabique, Pinzas cortantes para maxilares
 Pinze taglianti nasali, Pinza per ammaccare il setto, Pinze taglianti per seno mascellare

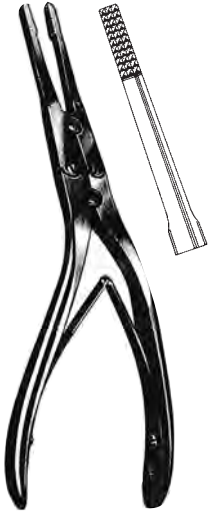

RUBIN
 47251-21
 21 cm, 8 1/4"

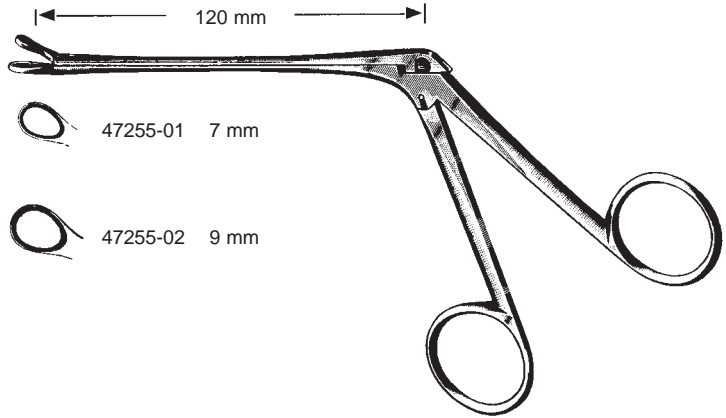

WATSON-WILLIAMS
 47255-01

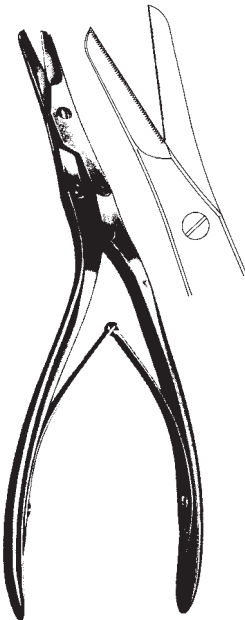

CAPLAN
 47256-20
 20 cm, 8"



KERRISON
 3x3 mm 47303-03
 4x4 mm 47303-04
 5x5 mm 47303-05
 6x6 mm 47303-06
 17 cm, 6 3/4"

Kieferhöhlenstanze, Nasenschere
 Antrum Punch Forceps, nasal scissors
 Pinzas cortantes para maxilares, tijera nasal
 Pinze sfenoidali, forbici nasali



47304-01 5x3,5 mm

47304-03 5x4 mm



47304-02 5x3,5 mm

47304-04 5x4 mm

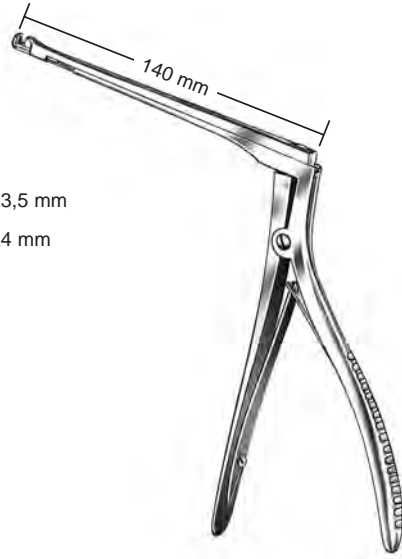

HAJEK-KOFLER
 47304-01 - 47304-04

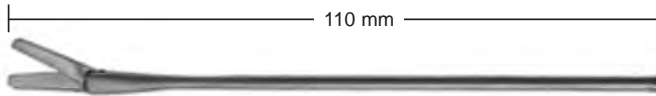

47305-02
 rechts gebogen
 right curved
 curva a la derecha
 curva a destra



47305-03
 links gebogen
 left curved
 curva a la izquierda
 curva a sinistra



47305-01
 gerade
 straight
 recta
 retta

Knochenstanze, Septumzangen

Punches, Septum Forceps

Pinzas osteótomos, Pinzas para el tabique nasal

Pinze osteotomi, Pinze per il setto nasale

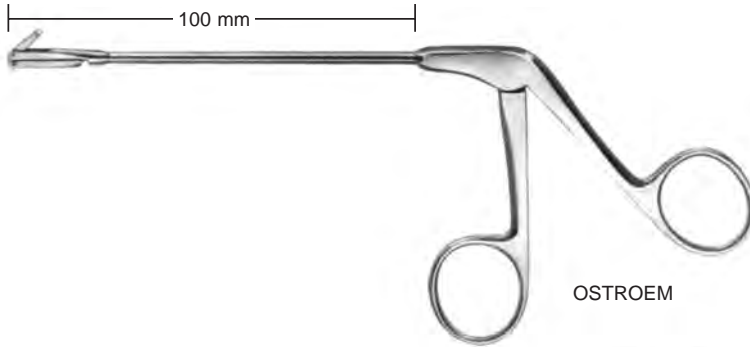

OSTROEM



47315-00
2 mm
oben schneidend
up cutting
cortante por arriba
tagliente in alto



47316-00
2 mm
rechts schneidend
right cutting
cortante a la derecha
tagliente a destra



47317-00
2 mm
links schneidend
left cutting
cortante a la izquierda
tagliente a sinistra



CITELLI
47311-10 1,0 mm
47311-25 2,5 mm
47311-30 3,0 mm

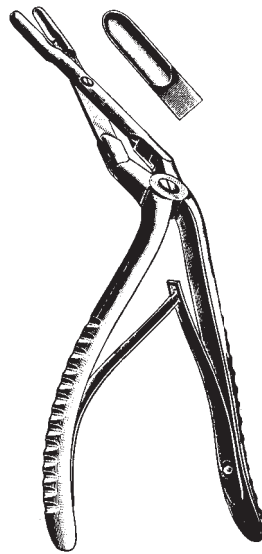

MIDDLETON-JANSEN
47323-19
19 cm, 7 1/2"

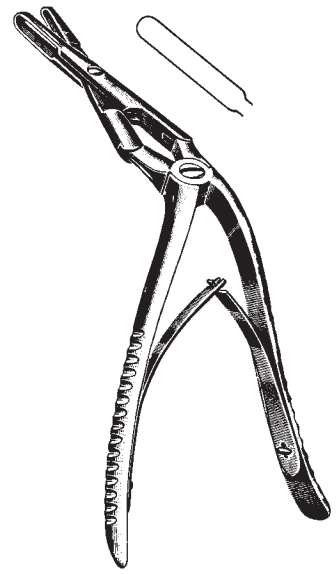

MIDDLETON-JANSEN
47325-19
19 cm, 7 1/2"

Kieferhöhlenstanze, Sinuskopie-Zangen
 Antrum Punch Forceps, Sinuscopy forceps
 Pinzas cortantes para maxilares, Pinzas para senoscopia
 Pinze sfenoidali per seno mascellare, Pinze per sinuscopia



HAJEK-KOFLER
 47316-16
 3,5 mm



	Maul jaw boca morso		horizontal öffnend horizontal cutting abierta horizontal apertura orizzontale	vertikal öffnend vertical cutting abierta vertical apertura verticale
65°	○ 3 mm rund		47317-65	47318-65
70°	◌	} oval	47317-70	47318-70
90°	◌		47317-90	47318-90
110°	◌		47317-11	47318-11

Zirkular Stanze
Circular Forceps
Pinza circular
Pinza circolare



47319-35 3,5 mm
47319-45 4,5 mm

Spülkanülen, Punktionskanüle, Stirnhöhlerdilator
 cannulas, Antrum trocar needle, Frontal sinus bougies
 cánulas, cánula de punción, Dilatador para el seno
 cannulas, cannula per punzione, Dilatatore per seno frontale

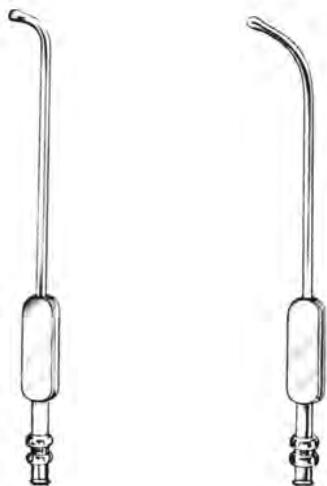

EICKEN (KILLIAN)
 14,5 cm, 5 ³/₄"

	Ø	
47331-20	2,0 mm	47332-20
47331-25	2,5 mm	47332-25
47331-30	3,0 mm	47332-30
47331-40	4,0 mm	47332-40

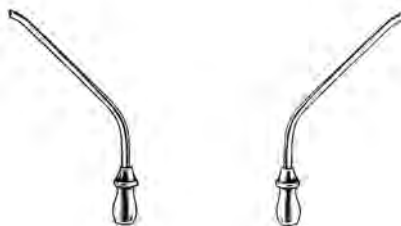

HARTMANN

Fig. 1	Ø	Fig. 2
47338-20	2,0 mm	47339-20
47338-25	2,5 mm	47339-25
47338-30	3,0 mm	47339-30



Ø mm LICHTWITZ
 1,5 47340-15
 1,8 47340-18
 2,0 47340-20
 Luer-Lock
 10 cm, 4"



Ø mm RITTER-HALLE
 2,5 47342-25
 3,0 47342-30
 4,0 47342-40

Kiefer- und Stirnhöhlen-Spülkanülen, Saugraspatorium
 Antrum and Frontal Sinus Wash Cannulas, Suction Raspatory
 Cànulas lavadoras para seno maxilar y seno frontal, Legra de succión
 Cannule per seno mascellare e seno frontale, Raspatorio con aspiratore

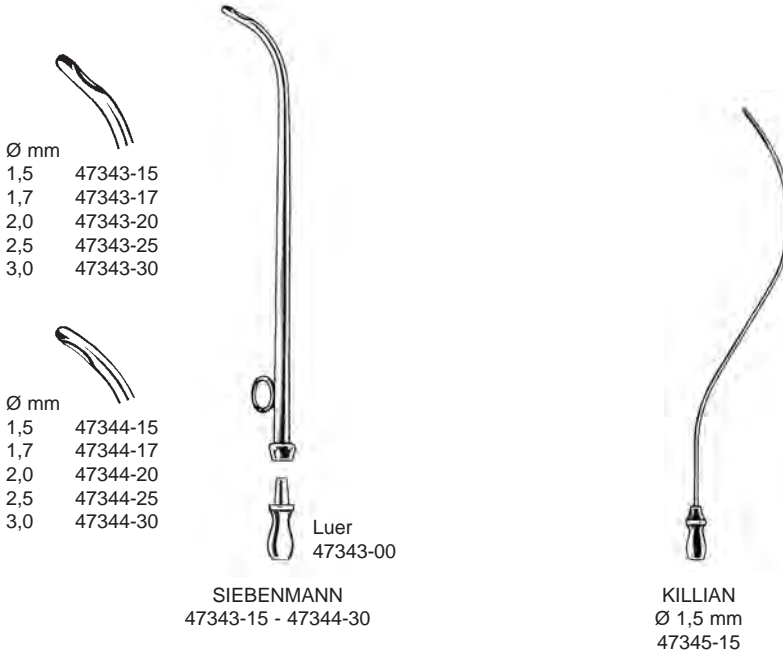

Polypenschnürer
Ear Polypus Snares
Polipótomos
Serranodi



KRAUSE-VOSS
47350-26
26 cm, 10 1/4"



KRAUSE
47351-26
26 cm, 10 1/4"

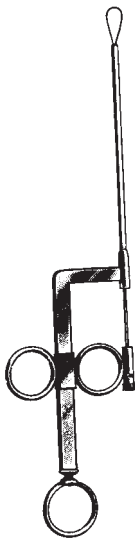

WILDE
47352-24
24 cm, 9 1/2"



12x

47355-03 0,3 mm

Nasenmesser
Nasal Knives
Bisturies nasales
Coltelli nasali



JOSEPH
47370-16 - 47373-16
16 cm, 6 1/4"



47370-16 47371-16
stumpf, blunt,
romos, smussi



47372-16 47373-16
spitz, pointed,
agudos, acuti



FREER
47374-16
16,5 cm, 8 1/4"



FREER
47375-19
19 cm, 7 1/2"



JOSEPH
47375-16
16,5 cm, 6 1/2"

Nasenplastik- und Operationsmesser, Sichelmesser, Küretten
 Rhinoplastic and Nasal Knives, Septum Sickle Knives, Curettes
 Bisturías para plástica y operaciones de la nariz, Bisturías para el tabique nasal, Curetas
 Bisturi per la plastica ed operazioni nasali, coltelli per setto, Curette

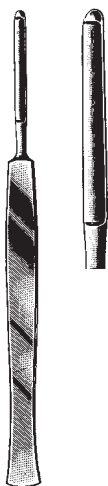

JOSEPH
 47376-16
 16 cm, 6 1/4"

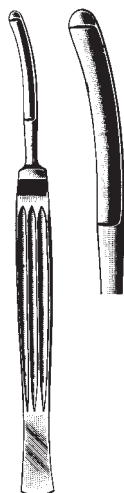

CONVERSE
 47379-16
 16 cm, 6 1/4"



COTTLE
 47380-15
 15 cm, 6"



COTTLE
 47382-15
 15 cm, 6"



JOSEPH
 47384-15
 15 cm, 6"



JOSEPH
 47385-15
 15 cm, 6"



REDA
 19 cm, 7 1/2"



47386-01
 spitz
 pointed
 agudo
 acuto



47386-02
 stumpf
 blunt
 romo
 smusso



ANTRUM
 19 cm, 7 1/2"



47387-01
 vorwärts schneidend
 forward cutting
 corte hacia adelante
 taglio in avanti



47387-02
 rückwärts schneidend
 backward cutting
 corte hacia atras
 taglio retrograde

Schwingmesser
Septum Swivel Knives
Bisturies para el tabique nasal
Coltelli per setto



47390-03
3 mm



47390-04
4 mm



47390-05
5 mm



47392-03
3 mm



47392-04
4 mm



47392-05
5 mm

BALLENGER
47390-03 - 47392-05
20 cm, 8"

Septum Elevatoren
 Septum Elevators
 Elevadores para el tabique
 Elevatori per setto



McKENTY
 47410-04 - 47410-05
 15 cm, 6"



47410-04
 4 mm

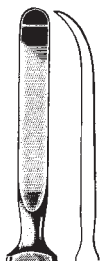

47410-05
 5 mm



HALLE
 47410-16
 16.5 cm, 6 1/2"



JOSEPH
 47411-16
 16 cm, 6 1/4"

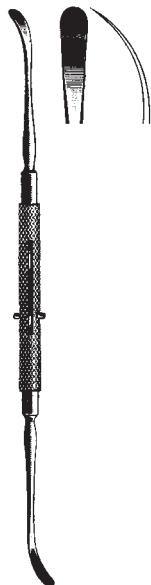

ROGER
 47413-19
 19 cm, 7 1/2"



FREER
 47415-18
 18 cm, 7"



FREER
 47417-19
 19 cm, 7 1/2"

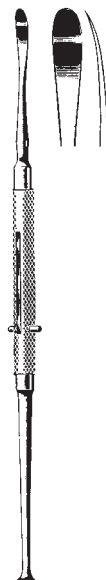

FREER
 47419-19
 19 cm, 7 1/2"

Septum Elevatoren
 Septum Elevators
 Elevadores para el tabique
 Elevatori per setto



KILLIAN
 47420-01
 18,5 cm, 7 1/4"



PIERCE
 47420-02
 21 cm, 8 1/4"



SINUS
 47420-03
 18 cm, 7"



PENNINGTON
 47420-04
 21 cm, 8 1/4"



McKENTY
 47420-20
 22 cm, 8 3/4"



HOWARTH
 47421-21
 21,5 cm, 8 1/2"

Septum Elevatoren
Septum Elevators
Elevadores para el tabique
Elevatori per setto

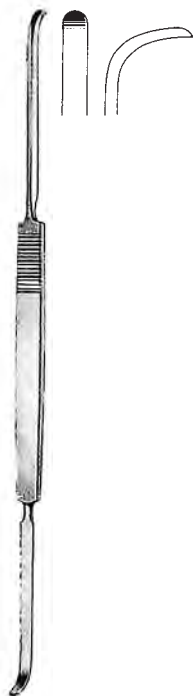

COTTLE
47421-23
23 cm, 9"



COTTLE JOSEPH
47422-22
22 cm, 8 3/4"



COTTLE
47423-22
22 cm, 8 3/4"

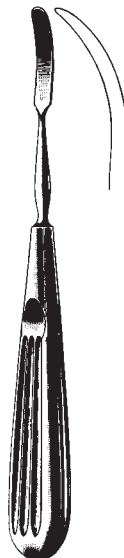

COTTLE
47424-16
16 cm, 6 1/4"



COTTLE
47425-19
19 cm, 7 1/2"



KILLIAN
47426-22
22 cm, 8 3/4"



HAJEK-BALLENGER
47428-21
22 cm, 8 3/4"



BALLENGER
47430-22
22 cm, 8 3/4"



FREER
47450-04
15 cm, 6"

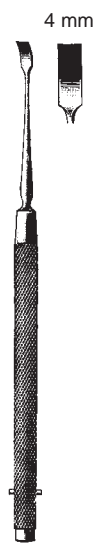

FREER
47451-04
15 cm, 6"

Septum Meißel, Knorpelquetscher
 Rhinoplastic Chisels, Cartilage crusher
 Cinceles para la plástica nasal, Macha cadera
 Scalpelli per plastica nasale, Tritacartilagine

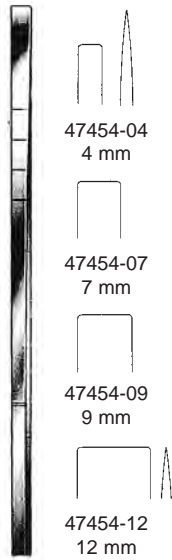

COTTLE
 47454-04 - 47454-12
 18 cm, 7"



COTTLE
 47455-06
 18 cm, 7"

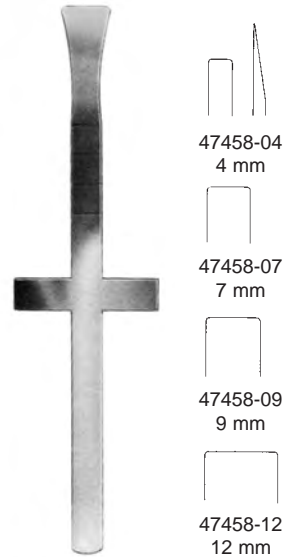

COTTLE
 47458-04 - 47458-12
 18 cm, 7"

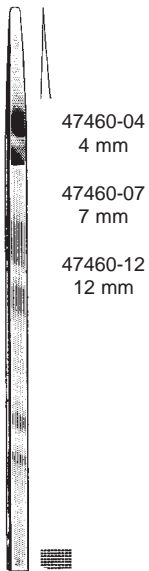

COTTLE
 47460-04 - 47460-12
 18 cm, 7"



COTTLE
 Knorpelquetscher
 47461-00



RUBIN
 18,5 cm, 7 1/4"

Septum Meißel
 Rhinoplastic Chisels
 Cinceles para la plàstica nasal
 Scalpelli per plastica nasale



FOMON
 47470-04 - 47470-07
 17 cm, 6 3/4"

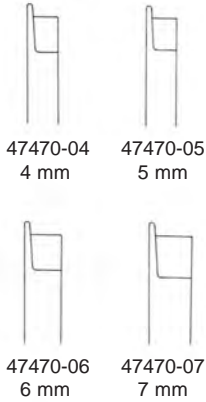

47470-04 4 mm
 47470-05 5 mm
 47470-06 6 mm
 47470-07 7 mm



SHEEHAN
 47471-07 - 47471-12
 16 cm, 6 3/4"

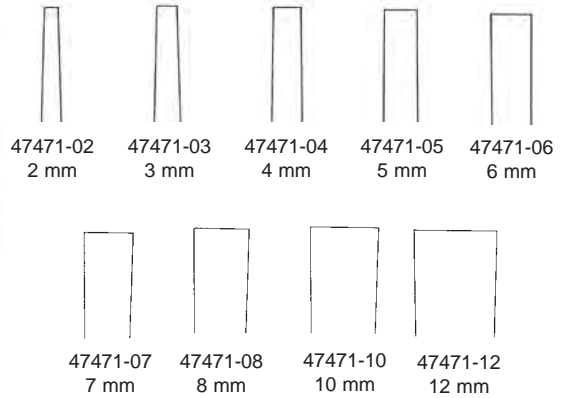

47471-02 2 mm
 47471-03 3 mm
 47471-04 4 mm
 47471-05 5 mm
 47471-06 6 mm
 47471-07 7 mm
 47471-08 8 mm
 47471-10 10 mm
 47471-12 12 mm



CINELLI
 47472-10 - 47472-16
 16 cm, 6 1/4"

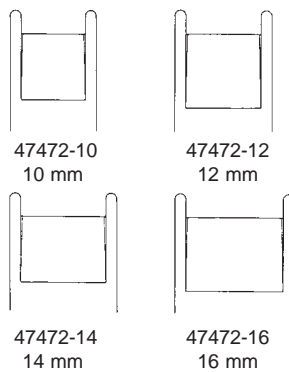

47472-10 10 mm
 47472-12 12 mm
 47472-14 14 mm
 47472-16 16 mm

Osteotom, Septum Meißel
 Osteotomes, Rhinoplastic Chisels
 Osteotomi, Cinceles para la plástica nasal
 Osteotomi, Scalpelli per plastica nasale

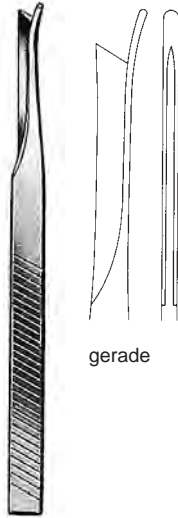

gerade

SILVER
 47473-01
 18 cm, 7"

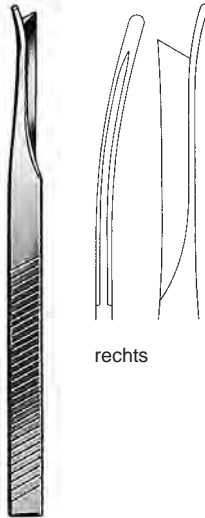

rechts

SILVER
 47473-02
 18 cm, 7"

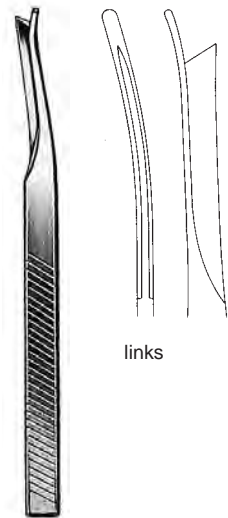

links

SILVER
 47473-03
 18 cm, 7"

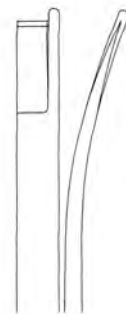

47474-01
 7 mm

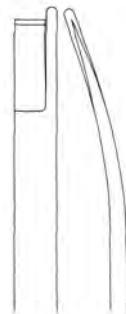

47474-02
 7 mm

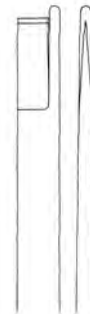

47474-03
 7 mm

NEIVERT-ANDERSON
 47474-01 - 47474-03
 20,5 cm, 8"

Septum Meißel
 Rhinoplastic Chisels
 Cinceles para la plástica nasal
 Scalpelli per plastica nasale



KILLIAN
 47481-05
 16 cm, 6 1/4"

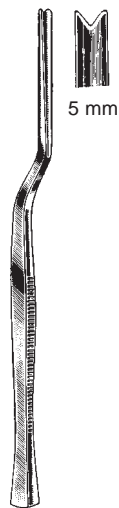

KILLIAN-CLAUS
 47482-05
 17 cm, 6 3/4"



mm	HAJEK
4	47484-04
6	47484-06
8	47484-08
	16 cm, 6 1/4"



WEST
 47486-16
 16 cm, 6 1/4"



WEST
 47487-16
 16 cm, 6 1/4"

6 mm



FREER
 47489-16
 16 cm, 6 1/4"



Nasenraspeln
 Nasal Rasps
 Escofinas nasales
 Raspa nasale

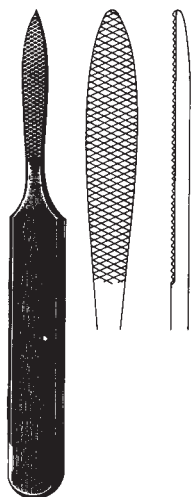

JOSEPH
 47502-16
 16 cm, 6 1/4"

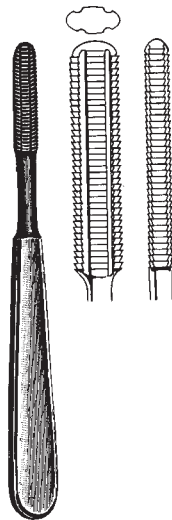

MALTZ
 47504-18
 18 cm, 7"



WIENER
 47507-17 - 47507-19
 18 cm, 7"



47507-17



47507-19



AUFRICHT
 47511-21 - 47513-21
 21 cm, 8 1/4"



47511-21

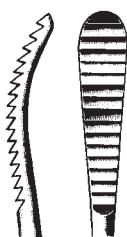

47513-21



JOSEPH (LEWIS)
 47514-16 - 47516-16
 18 cm, 7"



47514-16
 fein, fino
 fine, fina



47516-16
 grob, coarse,
 gruesa, grossa

Nasenraspeln
 Nasal Rasps
 Escofinas nasales
 Raspa nasale

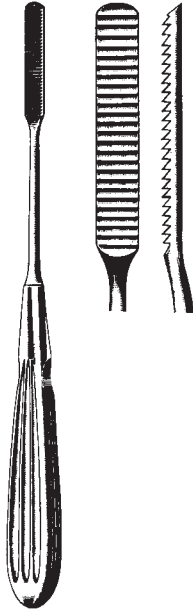

MALTZ (COTTLE)
 47518-21
 21 cm, 8 1/4"

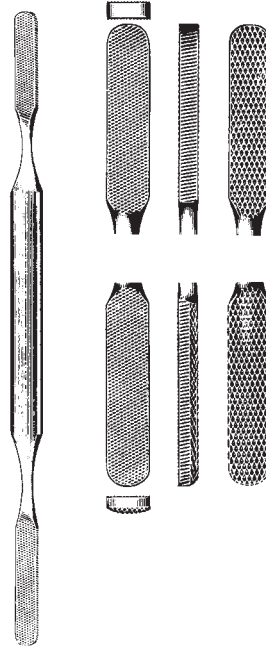

FOMON
 47520-21
 21 cm, 8 1/4"



MILLER
 18 cm, 7"

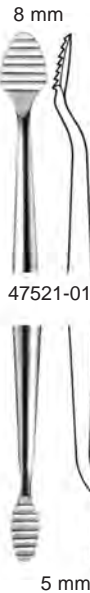

47521-01

5 mm



47521-02

4,3 mm



47521-03

5 mm

Nasenraspeln
Nasal Rasps
Escofinas nasales
Raspa nasale



FOMON

47522-01 - 47522-09 TC

20 cm, 8"



Fig. 1/2

47522-01 TC



Fig. 3/4

47522-04 TC



Fig. 5/6

47522-05 TC



Fig. 7/8

47522-07 TC



Fig. 9/10

47522-09 TC

Nasenraspeln, Nasensägen
 Nasal Rasps, Nasal Saws
 Escofinas nasales, Sierras nasales
 Raspa nasale, Seghe nasale



PEET
 47523-01 —
 47523-02 —
 19 cm, 7 1/2"



GALLAHER
 47526-16 - 47529-16
 16 cm, 6 1/4"



Fig. 1
 47526-16



Fig. 2
 47527-16

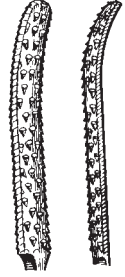

Fig. 3
 47529-16



JOSEPH
 47535-01 47535-02
 17 cm, 6 3/4"

gerade
 straight
 redo
 retta



links
 left
 izquierda
 a sinistra



rechts
 right
 derecha
 a destra

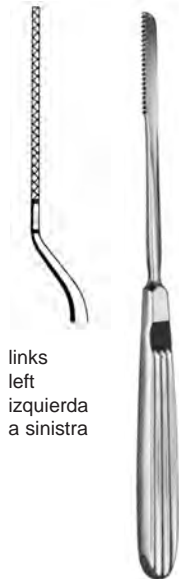

JOSEPH
 47532-19 47533-19 47534-19
 19 cm (7 1/2")

Nasenhaken
Nasal retractor
Retractores nasales
Retrattori nasali



COTTLE
47540-16
16 cm, 6 1/4"



MASING
47541-14
14 cm, 5 1/2"



AUFRICHT
47542-12
12 cm, 4 3/4"



AUFRICHT
47551-16
16 cm, 6 1/4"



AUFRICHT
47551-16L
16 cm, 6 1/4"



MASING-NEIVERT
47552-16
16 cm, 6 1/4"

Nasenhaken, Hauthäkchen
 Nasal retractor
 Retractores nasales, Ganchos para la piel
 Retrattori nasali, uncini nasali

10 x 12 mm



COTTLE
 47553-15
 15 cm, 6"



47554-01

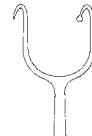

47554-02



47554-03

COTTLE
 14,5 cm, 5 3/4"

3 x 11 mm



KILNER
 47555-08
 8 cm, 3 1/8"



FOMON
 47556-16
 16 cm, 6 1/4"



FOMON
 47557-17
 17 cm, 6 3/4"

Hauthäkchen, Columella Pinzette
 Retractor, Columnella forceps
 Ganchos para la piel, Pinza para columella
 Uncini, Pinzetta columella



FREER
 47558-15
 15 cm, 6"

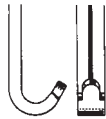

COTTLE-NEIVERT
 47559-20
 20 cm, 8"



GILLIES
 47560-18
 47562-18
 18 cm, 7"



Fig. 1



Fig. 2



LANGE
 47563-22
 23 cm, 9"



COTTLE
 47564-16
 16 cm, 6 1/4"



COTTLE
 47565-10
 10 cm, 4"

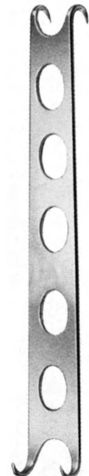

CONVERSE
 47566-12
 12 cm, 4 3/4"

Septumrichtzangen, Küretten
 Septum Straightening Forceps, Curettes
 Pinza para enderezar el tabique nasal, curetas
 Pinza per la plastica nasale, Curette



ASCH
 47571-23
 23 cm, 9"



WALSHAM
 47572-23 - 47575-23
 23 cm, 9"



47572-23
 gerade
 straight
 recta
 retta

47573-23
 links
 left
 izquierda
 a sinistra

47575-23
 rechts
 right
 derecha
 a destra

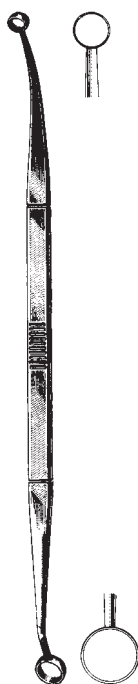

FAULKNER
 47601-21
 21 cm, 8 1/4"



COAKLEY
 47607-01 - 47607-06
 17 cm, 6 3/4"



47607-01
 Fig. 1



47607-02
 Fig. 2



47607-03
 Fig. 3



47607-04
 Fig. 4



47607-05
 Fig. 5



47607-06
 Fig. 6

Ringmesser, Innendurchmesser
 Adenoid Curettes, inner diameter
 Cuchillos para vegetaciones adenoides, camera diámetro
 Coltelli per vegetazioni adenoidi, interno diametro

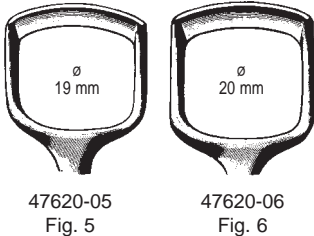
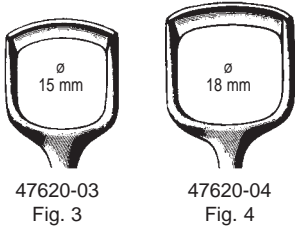
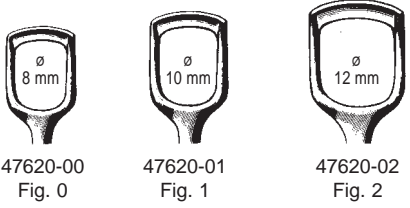

BECKMANN
 47620-01 - 47620-06
 22 cm, 8 3/4"



St. CLAIR-THOMSON
 47636-01 - 47636-04
 21 cm, 8 1/4"

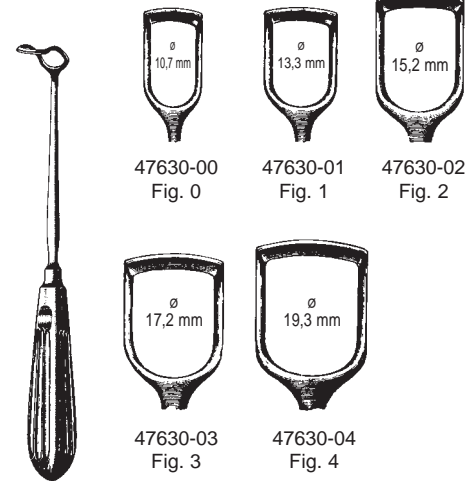

BARNHILL
 47630-01 - 47630-04
 21 cm, 8 1/4"

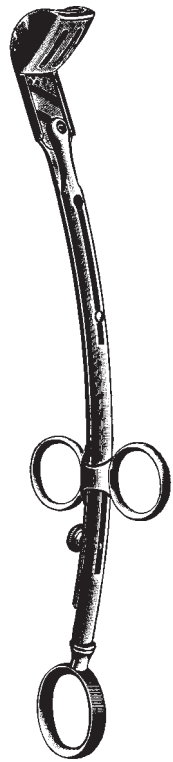

LAFORCE
 47641-01 - 47641-03
 25 cm, 10"

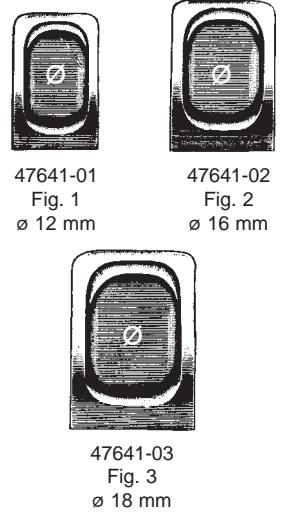

Ersatzklingen allein, gelocht
 Spare blades, perforated
 Hojas de repuesto, perforadas
 Lame di ricambio, forate

Fig. 1 47642-01
 Fig. 2 47642-02
 Fig. 3 47642-03

Zungenspatel, Wangen- und Lippenhalter
 Tongue Depressors, Cheek and Lip Retractors
 Baja-lenguas, Separadores para labios y mejillas
 Abbassalingua, Divaricatori per guance e labbra

Holz
 wood
 madera
 legno



49102-16
 16 cm, 6 1/4"
 Pack. à 100



MAYO
 49103-17
 17 cm, 6 3/4"



KROENIG
 49104-15
 15 cm, 6"



FRENZEL
 49105-16
 16,5 cm, 6 1/2"



49106-01
 14,5 cm, 5 3/4"



49106-02
 14,5 cm, 5 3/4"



BRUENINGS
 49107-19
 19 cm, 7 1/2"



CAWOOD-MINNESOTA
 49108-15
 15 cm, 6"



BUCHWALD
 49109-19
 19 cm, 7 1/2"

Zungendrucker
Tongue Depressors
Baja-lenguas
Abassalingua



MORITZ-SCHMIDT
49110-19
19 cm, 7 1/2"

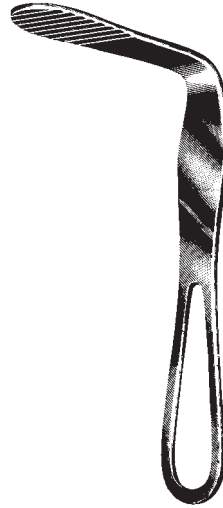

HARTMANN
49111-15
15 cm, 6"



49115-01
Fig. 1
14 cm, 5 1/2"



49115-02
Fig. 2
15 cm, 6"

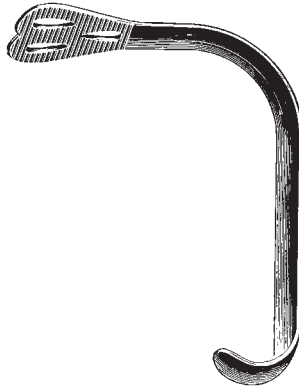

WIEDER
49115-01 - 49115-02



ANDREW
49117-11
11 cm, 4 3/8"

Zungendrucker, Wangen- und Lippenhalter, Zungenzangen
 Tongue Depressor, Cheek and Lip Retractor, Tongue Holding Forceps
 Baja-lenguas, Separadores para labios y mejillas, Pinza tira-lenguas
 Abassalingua, Divaricatori per guance e labbra, Pinza tiralingua

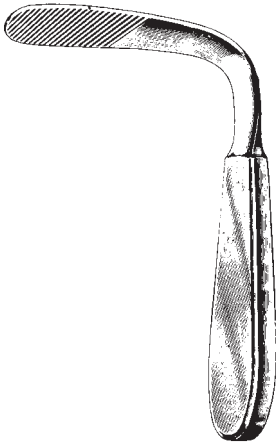

TOBOLD
 49119-14
 14,5 cm, 5 3/4"

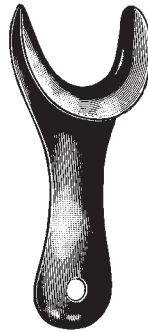

49230-11
 11 cm, 4 3/8"



STERNBERG
 49231-12 12 cm, 4 3/4"
 49231-14 14 cm, 5 1/2"
 49231-16 16 cm, 6 1/4"



49235-19
 19 cm, 7 1/2"

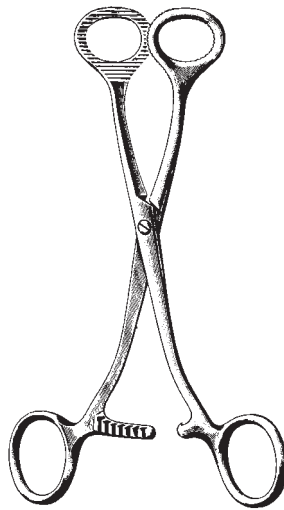

COLLIN
 49250-16 16 cm, 6 1/4"
 49250-18 18 cm, 7"



YOUNG
 49255-16
 16 cm, 6 1/4"



49255-99
 Ersatzgummibacken (Paar)
 Spare (Pair)
 Repuesto (pareja)
 Ricambio (coppia)

Mundsperrer
Mouth Gags
Abre-Bocas
Apribocca

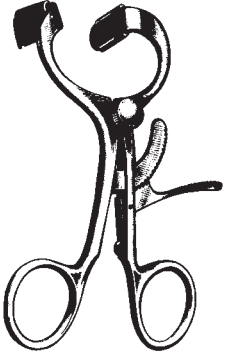

DOYEN-JANSEN (MOLT)
49265-12
12 cm, 4 ³/₄"

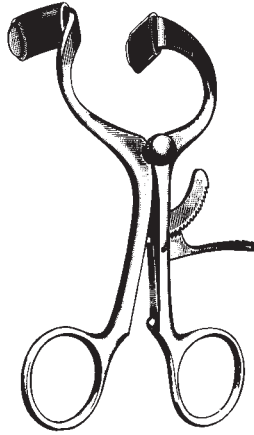

DOYEN-JANSEN (MOLT)
49265-14
14 cm, 5 ¹/₂"

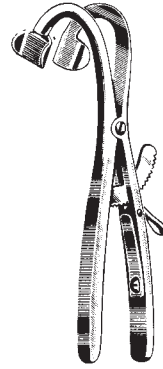

DENHART
49267-12
12 cm, 4 ³/₄"

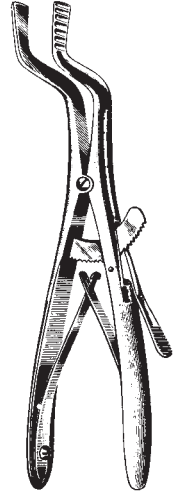

ROSER-KOENIG
49270-16 16 cm, 6 ¹/₄"
49270-19 19 cm, 7 ¹/₂"

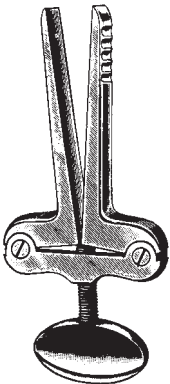

HEISTER
49272-13
13 cm, 5 ¹/₈"

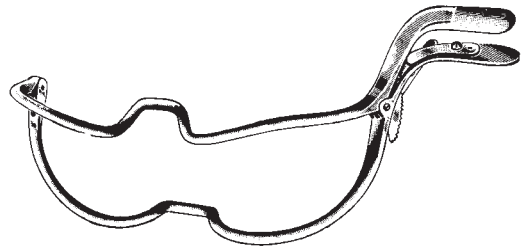

JENNINGS
49274-09 9 cm, 3 ¹/₂"
49274-11 11 cm, 4 ³/₈"
49274-13 13 cm, 5 ¹/₈"
49274-15 15 cm, 6"

Zungenspatel, Mundsperrer
 Tongue depressor, Mouth Gags
 Baja-lengua, Abrebocas
 Abbassalingua, Apribocca



linke Seite
 left side
 izquierda
 lato sinistro

rechte Seite
 right side
 derecha
 lato destro

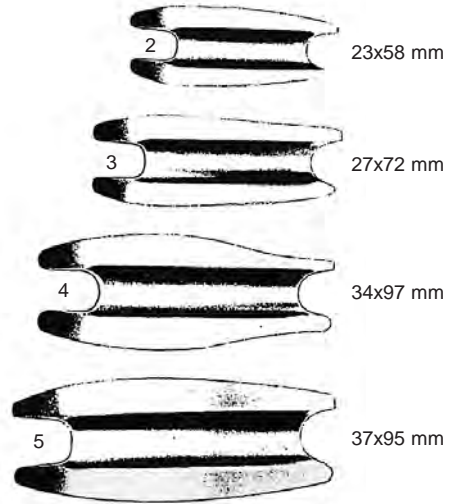

2 23x58 mm

3 27x72 mm

4 34x97 mm

5 37x95 mm

RING

- | | | |
|----------|--------|----------|
| 49287-02 | Fig. 2 | 49288-02 |
| 49287-03 | Fig. 3 | 49288-03 |
| 49287-04 | Fig. 4 | 49288-04 |
| 49287-05 | Fig. 5 | 49288-05 |

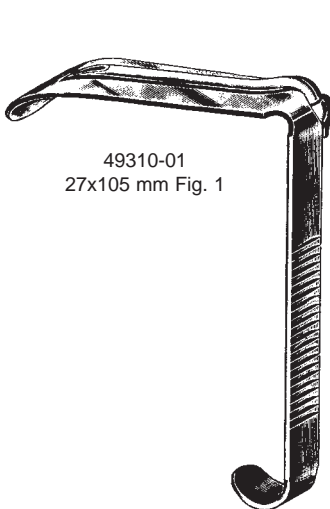

49310-01
 27x105 mm Fig. 1

DAVIS-BOYLE
 49310-00
 compl.



49310-02
 25x90 mm Fig. 2



49310-03
 25x75 mm Fig. 3



49310-04
 22x60 mm Fig. 4



49310-05
 20x25 mm Fig. 5

49310-08 Silikoneinlagen/Silicone pads
 inserto de silicona/inserto in silicone

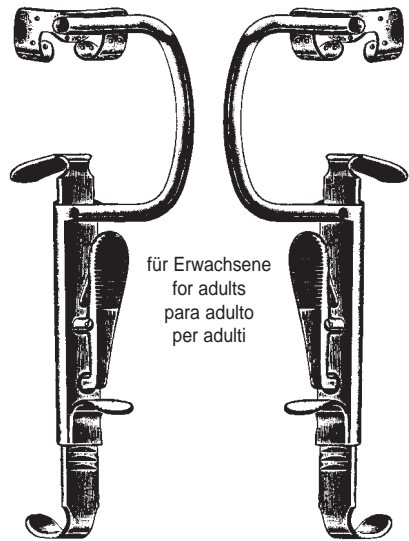

für Erwachsene
 for adults
 para adulto
 per adulti

49310-10
 Sperrer allein, links
 Gag only, left
 Abre-boca suelta, izquierda
 Apribocca solo, sinistra

49310-12
 Sperrer allein, rechts
 Gag only, right
 Abre-boca suelta, derecha
 Apribocca solo, destra

Mundsperrer
 Mouth Gags
 Abre-Bocas
 Apribocca

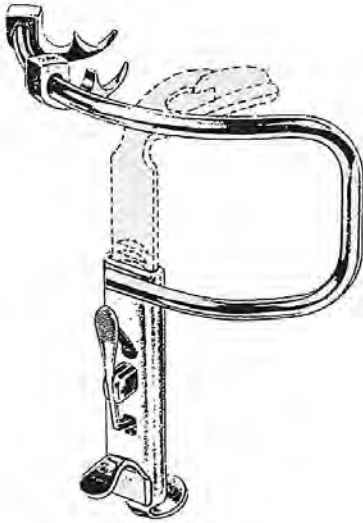

49315-10
 Sperrer allein
 Gag only
 Abre-boca solo
 Apribocca solo



49315-01
 Fig. 1



49315-02
 Fig. 2



49315-03
 Fig. 3

KILNER-DOUGHTY
 49315-00
 compl.

49317-00 DINGMANN, komplett
 mit 3 auswechselbaren Zungendrucker,
 2 seitliche Wangenhaken und 2 Zahnhaken

with 3 interchangeable tongue depressors,
 2 rotating cheek holders
 2 movable tooth hooks and thread guide

con 3 baja lenguas intercambiables,
 2 valvas giratorias p. los labios,
 2 ganchos graduables

con 3 depressori intercambiabili,
 2 valve laterali rotative
 2 uncini a denti movibile

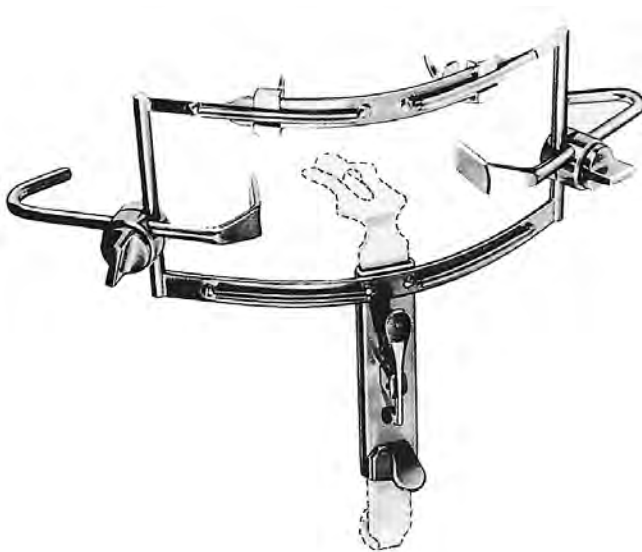

DINGMANN
 49317-10
 Sperrer allein, Gag only
 Abre-boca solo, Apribocca solo



1 24x62 mm
 49317-01



2 28x65 mm
 49317-02

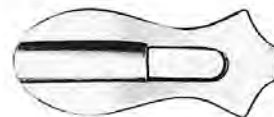

3 31x75 mm
 49317-03

Mundsperrer
Mouth Gag
Abre-bocas
Apribocca

49320-20
Silikon-Schlauch
Silicon Tubing
tubo de silicona
tubo in silicone

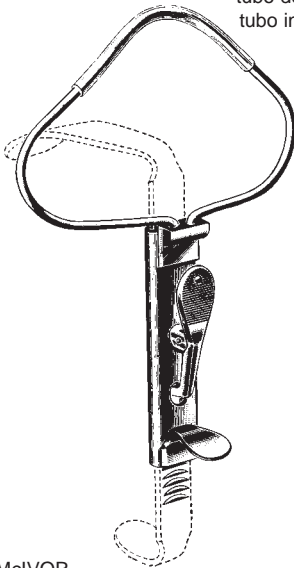

McIVOR
49320-00
compl.

49320-10

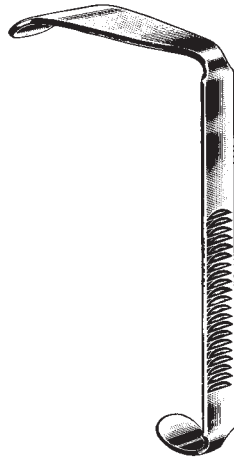

49320-01
27x95 mm Fig. 1

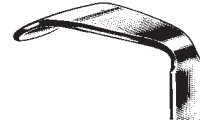

49320-02
22x85 mm Fig. 2



49320-03
22x70 mm Fig. 3



DAVIS-MEYER
49340-00

Zungenspatel
 Tongue blades
 Baja-lenguas
 Abbassalingua

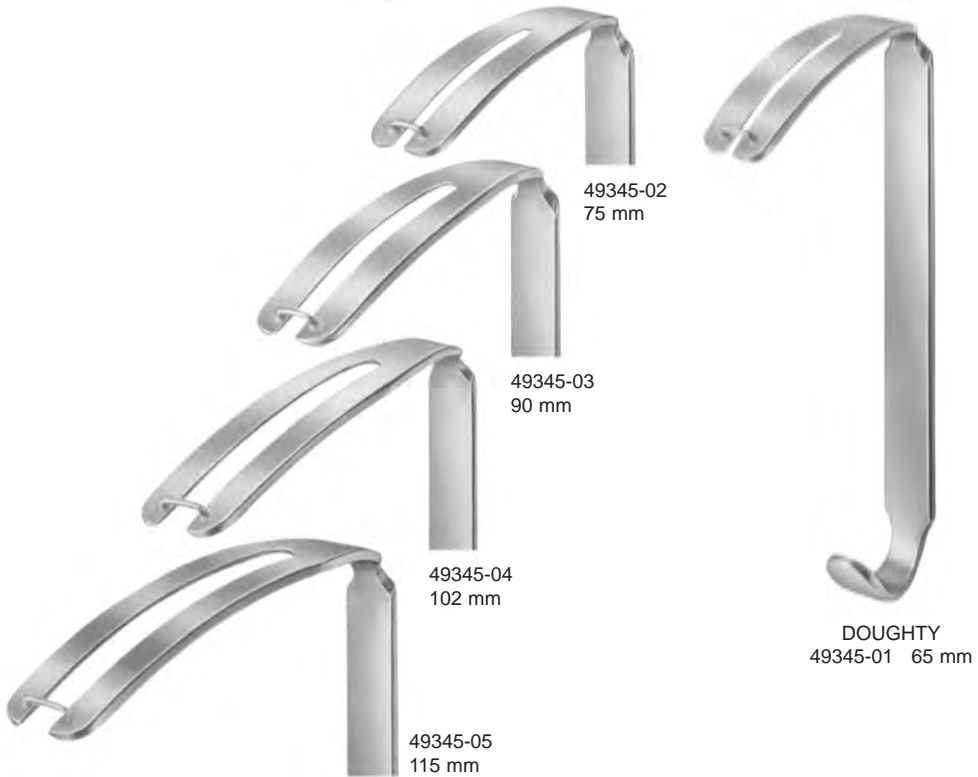

Mundkeil, Repositionszangen, Bruststütze
 Oral Wedges, Disimpaction Forceps, Chest Support
 Pinzas para reposiciones, Soporte de pecho
 Pinze per riposizione, Supporto per petto

Holz
 wood
 madera
 legno



MAUNDER
 49360-10



NEGUS
 49400-01



links
 left side
 izquierda
 lato sinistro

ROWE

- 49501-22 22,5 cm, 8.9"
- 49501-23 23,5 cm, 9 1/4"
- 49501-24 24,0 cm, 9 1/2"



rechts
 right side
 derecha
 lato destro

ROWE

- 49503-22 22,5 cm, 8.9"
- 49503-23 23,5 cm, 9 1/4"
- 49503-24 24,0 cm, 9 1/2"

Wundhaken für Mund-Kiefer-Gesicht
 Retractors for Mouth-, Jaw- and Face Surgery
 Separadores para cirugía plástica
 Divaricatori per chirurgia plastica



49605-07
25x7 mm

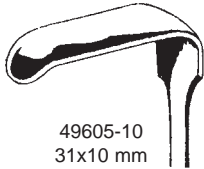

49605-10
31x10 mm

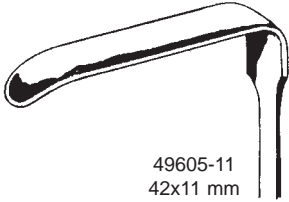

49605-11
42x11 mm

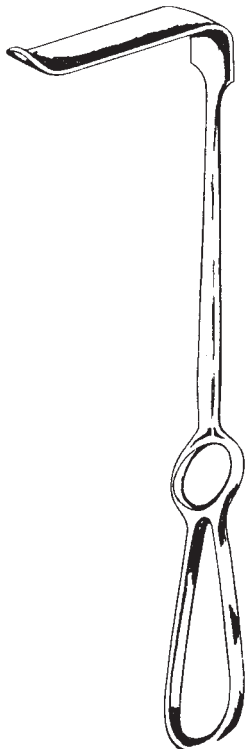

OBWEGESER
49610-12 - 49610-16
22 cm, 8 3/4"

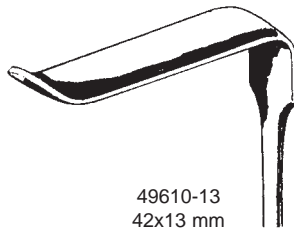

49610-13
42x13 mm

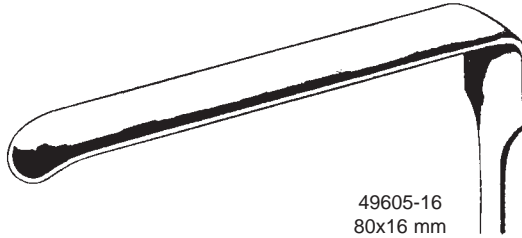

49605-16
80x16 mm

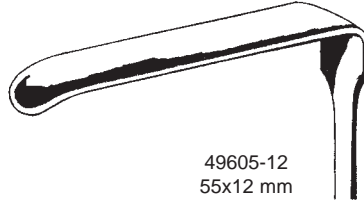

49605-12
55x12 mm

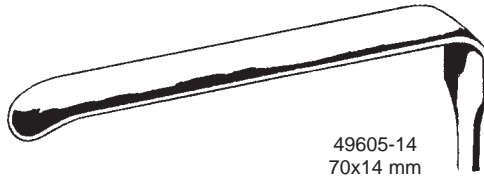

49605-14
70x14 mm



OBWEGESER
49605-07 - 49605-16
22 cm, 8 3/4"

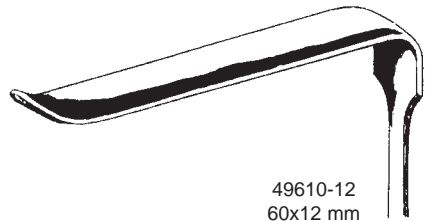

49610-12
60x12 mm

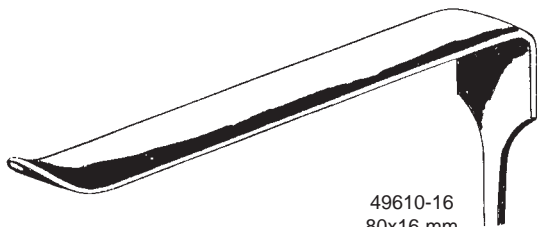

49610-16
80x16 mm

Wundhaken für Mund-Kiefer-Gesicht
 Retractors, Raspatories for Mouth-, Jaw- and Face Surgery
 Separadores Periostótomos para cirugía plástica
 Divaricatori, Periostotomi per chirurgia plastica

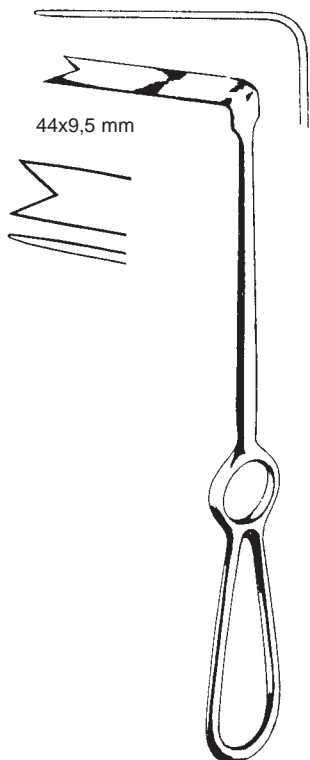

SPINA-NASALIS
 49613-10
 22 cm, 8 3/4"

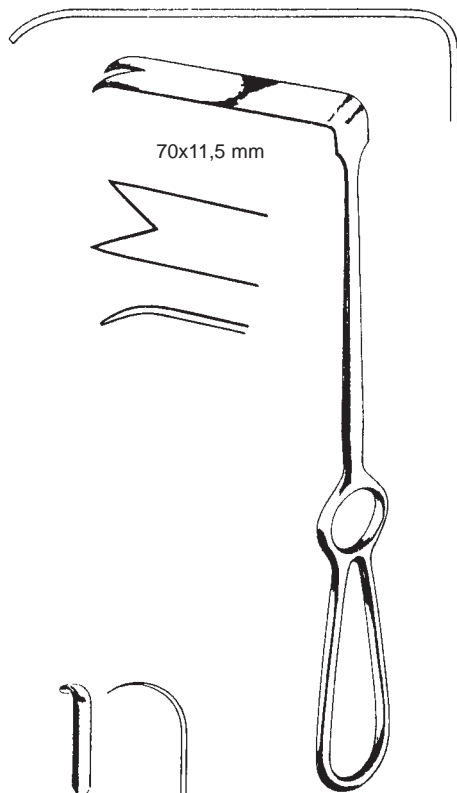

RAMUS
 49615-12
 22 cm, 8 3/4"



OBWEGESER
 49620-15
 15,5 cm, 6"

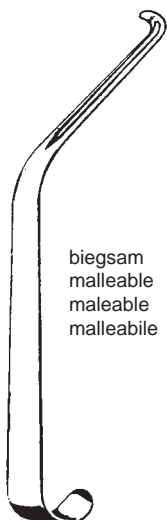

OBWEGESER
 49623-16
 16 cm, 6 1/4"



OBWEGESER
 49627-01
 21 cm, 8 1/4"

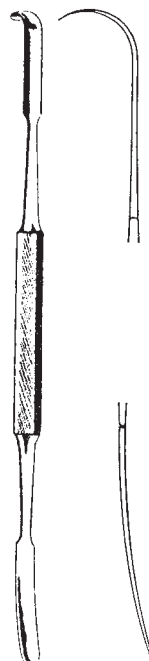

OBWEGESER
 49630-02
 20,5 cm, 8"

Raspatorien
 Periosteal Elevators
 Periostótomos
 Periostotomi



OBWEGESER
 49635-18
 17,5 cm, 7"



OBWEGESER
 49640-05 - 49640-09
 20 cm, 8"

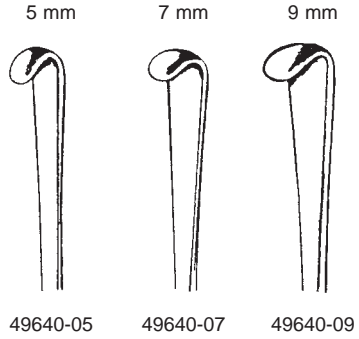

5 mm 7 mm 9 mm
 49640-05 49640-07 49640-09



OBWEGESER
 49650-06 - 49650-11
 17,5 cm, 7"



49650-06



49650-07



49650-09



49650-11

Raspatorien, Osteotom, Unterkieferhaken, Ahle
 Raspatories, Osteotome, Retractors for Mouth-, Jaw- and Face Surgery, Awls
 Periostótomos, Osteotomos, Separadores para cirugía plástica, Agujas
 Periostotomi, Osteotomo, Divaricatori per chirurgia plastica, Aghi

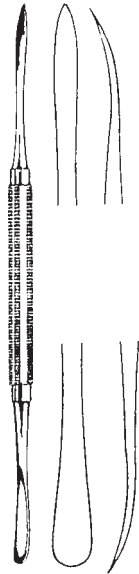

DINGMAN
 49660-18
 18 cm, 7"



OBWEGESER
 49665-24
 23,5 cm, 9 1/4"



HARGIS
 49670-19
 19 cm, 7 1/2"

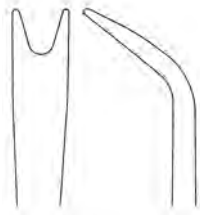

OBWEGESER
 49670-23
 23 cm, 9"

Intraorale Retraktoren
 Intra Oral Retractors
 Separadores intra orales
 Retrattori intraorali

26,5 / 16 mm



49671-01
 21 cm, 8 1/4"
 rechts
 right
 droite
 destra

26,5 / 16 mm



49671-02
 21 cm, 8 1/4"
 links
 left
 gauche
 sinistra

26,5 / 16 mm



49671-01 CL
 24,5 cm, 9 3/4"
 rechts
 right
 droite
 destra

26,5 / 16 mm



49671-02 CL
 24,5 cm, 9 3/4"
 links
 left
 gauche
 sinistra

Raspatorien
Periosteal Elevators
Legras
Elevatori per periostio



HARGIS
23 cm, 9"



49673-01
6,5 mm
rechts
right
derecha
destra



49673-02
9 mm
rechts
right
derecha
destra



49673-03
6,5 mm
links
left
izquierda
sinistra

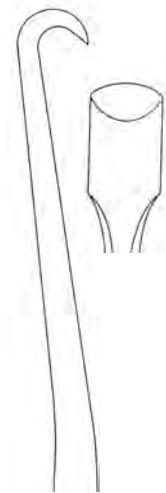

49673-04
9 mm
links
left
izquierda
sinistra

Raspatorien, Ahle, Haken
 Raspatories, Awls, Retractors for Mouth-, Jaw- and Face Surgery
 Periostótomos, Agujas, Separadores para cirugía plástica
 Periostotomi, Aghi, Divaricatori per chirurgia plastica



OBWEGESER
 49675-18
 18 cm, 7"

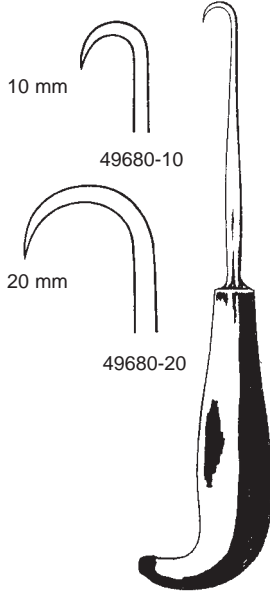

19 cm, 7 1/2"



DINGMAN
 49685-21
 21 cm, 8 1/4"

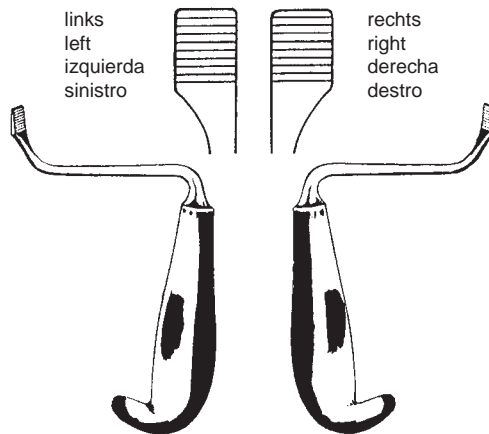

TESSIER
 49691-15
 15 cm, 6"

TESSIER
 49692-15
 15 cm, 6"

Intraorale Retraktoren
Intra Oral Retractors
Separadores intra orales
Retrattori intraorali



Sagittalspreizer
Sagittal Split Separators
Separadores sagitales
Separatori sagittali



SMITH
49695-01
18,5 cm, 7 1/4"
9 mm
rechts
right
derecha
destra



SMITH
49695-02
18,5 cm, 7 1/4"
9 mm
links
left
izquierda
sinistra

Unterkieferkörperhaken
Mandibular Body Retractor
Separador para el cuerpo mandibular
Separatore per il corpo mandibolare

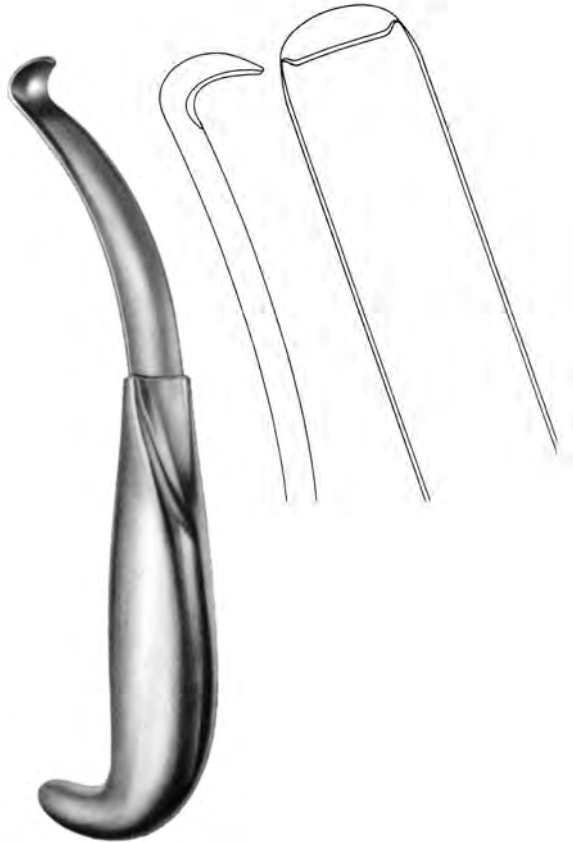

HARGIS
49696-18
18 cm, 7"

Osteotome
Osteotome
Osteótomos
Osteotomi



49700-01
21,5 cm, 8 1/2"



49700-02
21,5 cm, 8 1/2"

Blattosteotom
Blade Osteotomes
Osteótomos de hoja
Osteotomo a lama



49705-08
8 mm

49705-12
12 mm

49705-16
16 mm

49705-20
20 mm

OBWEGESER
22 cm, 8 3/4"

Osteotome
Osteotome
Osteótomos
Osteotomi

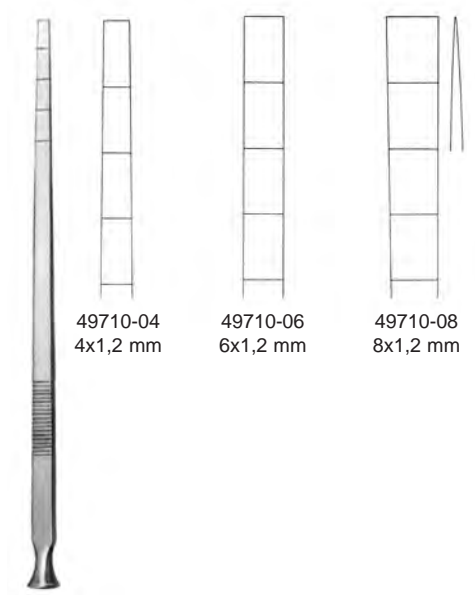

EPKER
18 cm, 7"

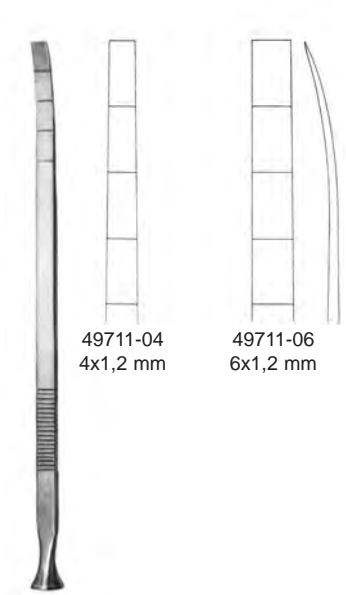

EPKER
18 cm, 7"

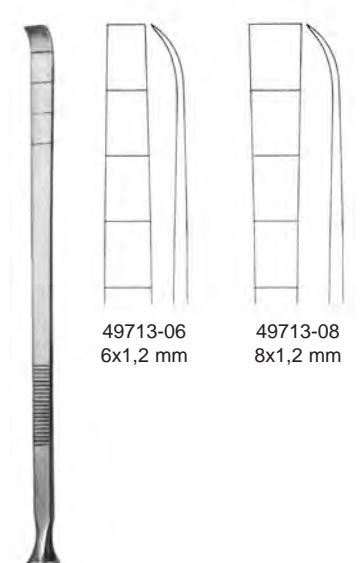

EPKER
18 cm, 7"

Wundhaken, Tonsillen-Elevatoren, Tamponstopfer
 Retractors, Tonsil-Elevators, Gauze packer
 Separadores, Elevadores para amígdalas, Tamponeador
 Divaricatori, Elevatori, Tamponatore

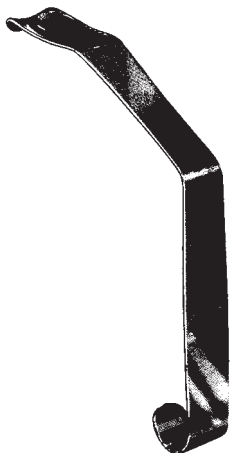

LOVE 15 cm, 6"
 51103-18 18 mm
 51103-20 20 mm
 51103-22 22 mm



HOFER
 51109-24
 24 cm, 9 1/2"



NAGER
 51111-23
 23 cm, 9"



HURD
 51131-22
 22 cm, 8 1/4"



LOPEZ-REINKE
 51133-23
 23 cm, 9"



YANKAUER
 51134-21
 21 cm, 8 1/4"



51135-01



HENKE
 23 cm, 9"



51135-02



CARPENTER
 51139-25
 25 cm, 10"



CARPENTER
 51143-24
 24 cm, 9 1/2"



LUNIATSCHEK
 51151-19
 19 cm, 7 1/2"

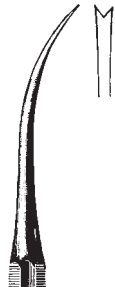

Tonsillen-Nadeln, Tonsillen-Messer

Tonsil Needles, Tonsil-Knives

Agujas para suturas de amígdalas, Bisturios para amígdalas

Aghi per tonsille, Coltelli per tonsille

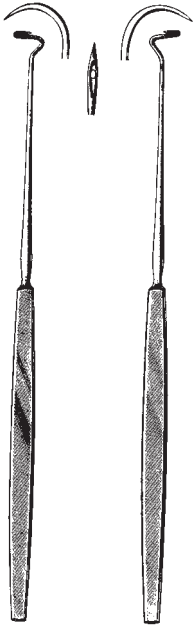

DUPUY-WEISS
51165-22 51167-22
22 cm, 8 3/4"



CLAUS
51168-23
23 cm, 9"



CLAUS-EICKEN
51169-23
23 cm, 9"



NAGER
51170-24
24 cm, 9 1/2"



FISHER
51171-22
22,5 , 9"



ABRAHAM
51172-19
19 cm, 7 1/2"



ABRAHAM
51173-21
21 cm, 8 1/4"



CANFIELD
51174-21
21 cm, 8 1/4"



BRUENINGS
51177-23
23 cm, 9"



DOUGLAS
51178-21
21 cm, 8 1/4"



DOUGLAS
51179-17
17 cm, 6 3/4"

Tonsillenzange
 Tonsil Seizing Forceps
 Pinzas para coger las amígdalas
 Pinze per tonsille

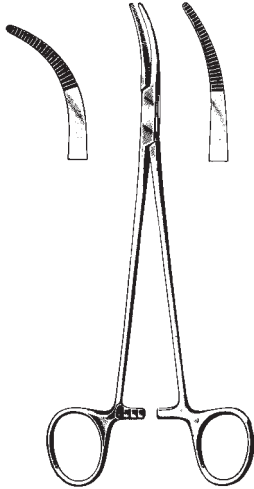

19 cm, 7 1/2"
 SAWTELL SCHNIDT
 51181-19 51183-19

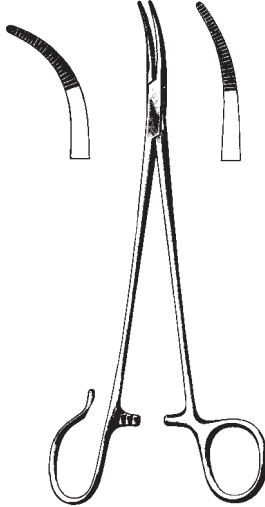

19 cm, 7 1/2"
 SAWTELL SCHNIDT
 51185-19 51187-19

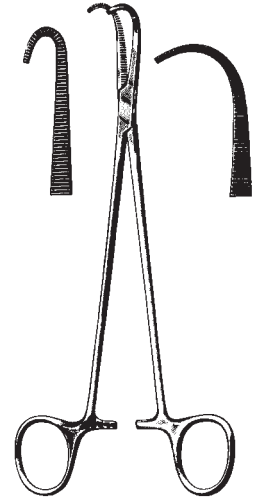

19 cm, 7 1/2"
 NEGUS NEGUS
 51191-19 51193-19

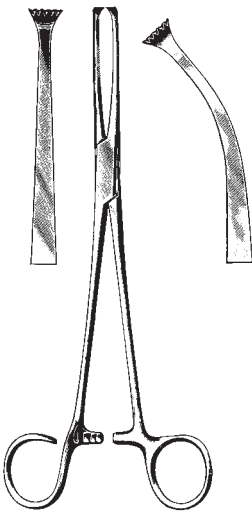

19 cm, 7 1/2"
 COLVER
 51202-19 51203-19

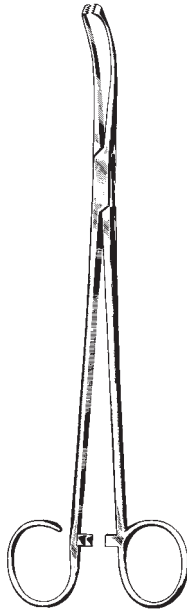

WHITE
 51205-18 18 cm, 7"
 51205-23 23 cm, 9"

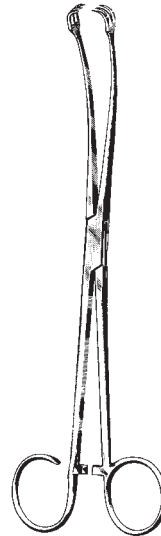

BALLENGER
 51207-21
 21,5 cm, 8 1/2"

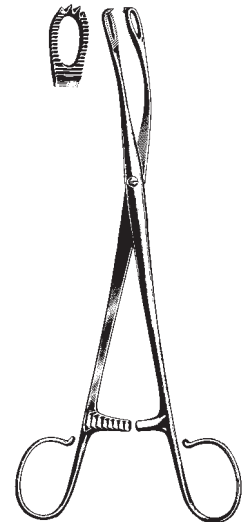

BLOHMKE
 51209-20
 20 cm, 8"

Tonsillen-Zangen u. -Pinzetten, Tonsillen-Kompressoren, Tonsillen-Schnürer
 Tonsil-Forceps, Tonsil-Snares
 Pinzas, Compresores para amígdalas, Cierra-nudos para amígdalas
 Pinze, Compressori per tonsille, Serranodi per tonsille



ABRAHAM
 51210-20
 20 cm, 8"

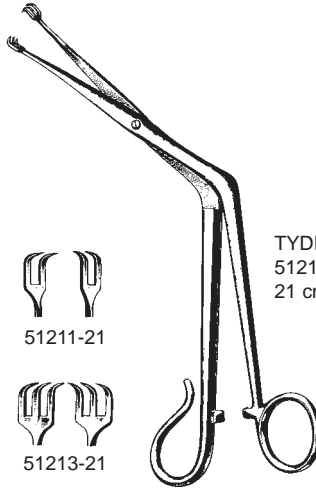

TYDING
 51211-21 - 51213-21
 21 cm, 8 1/4"



51211-21



51213-21

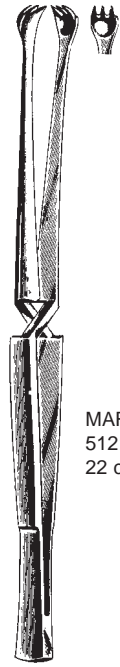

MARSCHIK
 51219-22
 22 cm, 8 3/4"



EVES
 51250-28
 28 cm, 11"



EVES
 51252-28
 28 cm, 11"



BRUENINGS
 51256-28
 28 cm, 11"

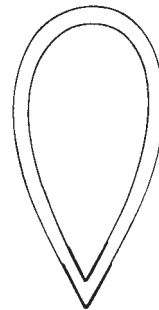

51257-40 40 mm
 51257-50 50 mm
 Pack of 100 pcs



51259-03 0,3 mm
 51259-04 0,4 mm
 51259-05 0,5 mm
 Pack of 12 pcs

Tonsillotom
Tonsillectomes
Amigdalótomos
Tonsillotomi

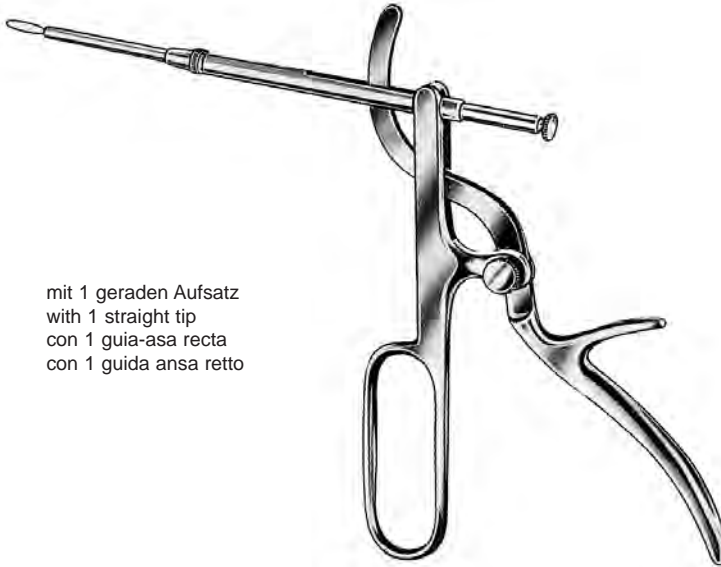

mit 1 geraden Aufsatz
with 1 straight tip
con 1 guida-asa recta
con 1 guida ansa retto

TYDING
51260-00

Tonsillotom, Spritzen, Septum Nadeln
 Tonsillectomes, Syringes, Septum needles
 Amigdalótomos, Jeringas, Septum aguja
 Tonsillotomi, Siringhe, Septum aghi

Aufsatz allein
 blade only
 hoja sola
 lama sola

51270-01

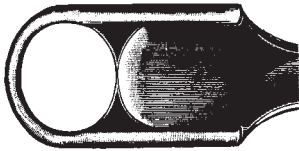

1

51270-02

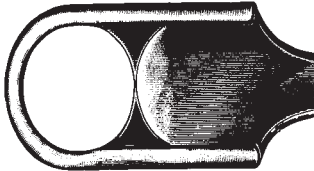

2

51270-03

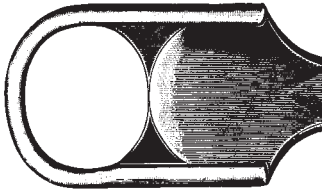

3

51270-04
 Handgriff allein
 Handle only
 mango para
 manipolo solo

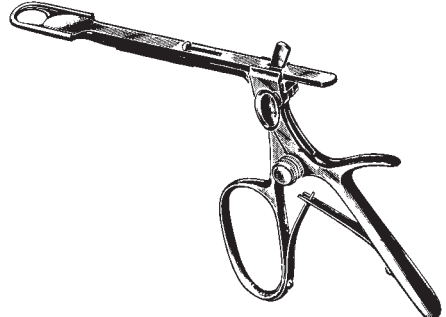

SLUDER-BALLENGER
 51270-00
 mit 3 Aufsätzen
 with 3 blades
 con 3 hojas
 con 3 lame

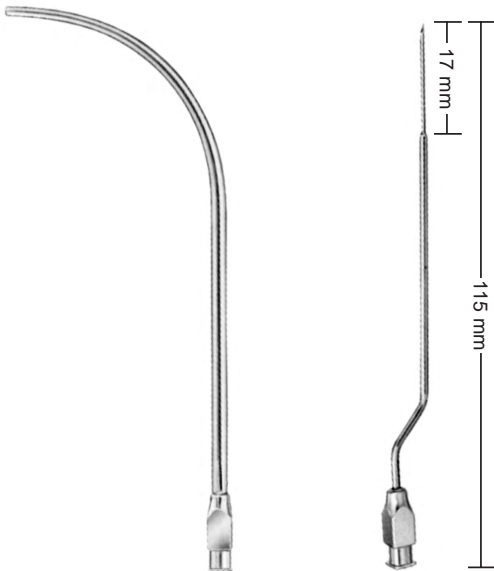

51291-00
 2,5 mm Ø

51293-00
 0,8 mm Ø

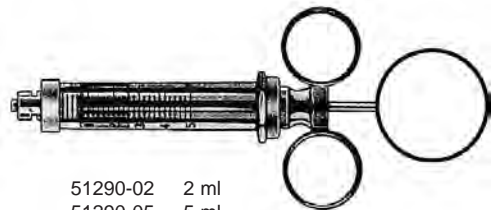

51290-02 2 ml
 51290-05 5 ml
 51290-10 10 ml
 51290-20 20 ml



51292-00

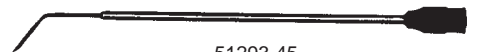

51293-45
 45°

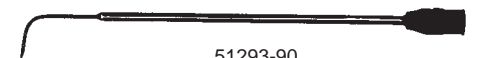

51293-90
 90°

Septum-Schere, Kehlkopfpolypenzangen, Deckelhalter
 Septum-Scissors, Laryngeal Polypus Forceps, Epiglottis Retractor
 Tijeras para septo, Pinzas para pólipos laríngeos, Depresor para epiglottis
 Forbice per il setto nasale, Pinze per polipi laringei, Depressore per epiglottide



KILLIAN
 53102-20
 20 cm, 8"



53101-22



53103-22



JACKSON
 53101-22 - 53103-22
 22 cm, 8 3/4"

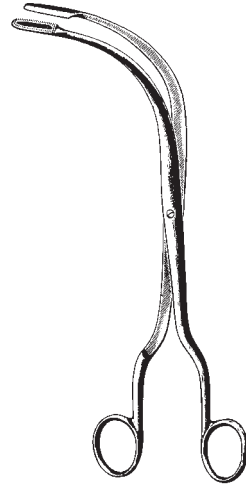

FRAENKEL
 53111-18
 18 cm, 7"

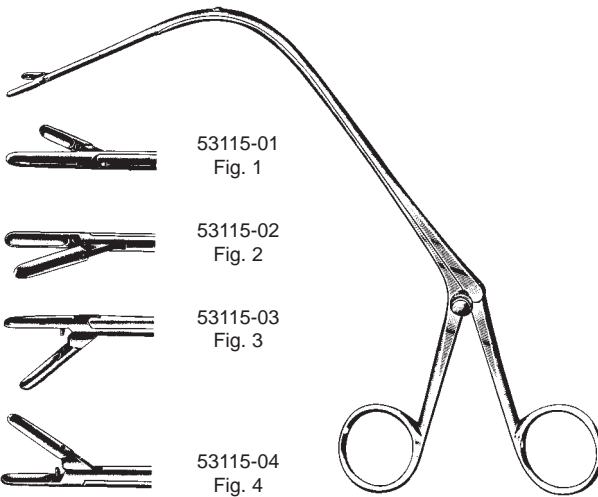

53115-01
 Fig. 1

53115-02
 Fig. 2

53115-03
 Fig. 3

53115-04
 Fig. 4

JURASZ
 53115-01 - 53115-04
 23 cm, 9"



REICHERT
 53121-24
 24 cm, 9 1/2"

Universalgriffe, Verlängerungsrohre, Aufsätze
 Universal Handles, Interchangeable Tips, Tips
 Mangos universales y Tubos de extension, Puntas
 Manici universali e Tubi di prolungamento, Terminale laringeo

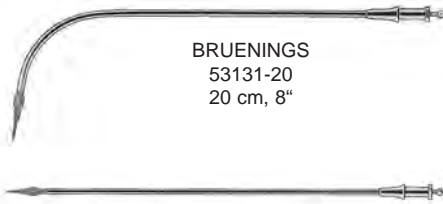

BRUENINGS
 53131-20
 20 cm, 8"

BRUENINGS
 53132-20 20 cm, 8" 53132-50 50 cm, 19 3/4"
 53132-30 30 cm, 11 3/4" 53132-60 60 cm, 23 1/2"
 53132-40 40 cm, 15 3/4"



HUBER
 53130-00



FRAENKEL
 53150-00



SEIFERT
 53152-00



FRAENKEL
 53154-00



SCHEINMANN
 53155-00



SCHEINMANN
 53157-00



BRUENINGS
 53158-02 - 53158-03

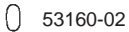

53160-02

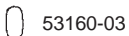

53160-03



BRUENINGS
 53160-02 - 53160-03



LANGE
 53162-00



53164-01



53164-02



KRAUSE
 53164-01 - 53164-02



KRAUSE
 53166-00



SCHUMACHER
 53170-00



BARACANI
 53175-00



53177-01



53177-02



CORDES
 53177-01 - 53177-02

Broncho-Oesophagoskopiezangen, Kehlkopfspiegel, Griffe
 Broncho-Esophagoscapy Forceps, Laryngeal Mirrors, Handles
 Pinzas para bronco-esofagoscopia, Espejos laringeos, Mangos
 Pinze per bronco-esofagoscopia, Specchi laringei, Manici

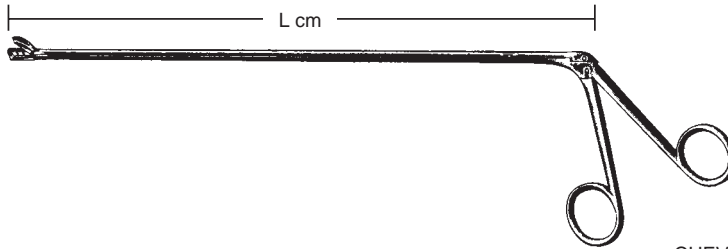

CHEVALIER-JACKSON
 53230-01 - 53260-08



cm	Fig. 1	Fig. 2	Fig. 3	Fig. 4	Fig. 5	Fig. 6	Fig. 7	Fig. 8
30 / 11 3/4"	53230-01	53230-02	53230-03	53230-04	53230-05	53230-06	53230-07	53230-08
40 / 15 3/4"	53240-01	53240-02	53240-03	53240-04	53240-05	53240-06	53240-07	53240-08
50 / 19 3/4"	53250-01	53250-02	53250-03	53250-04	53250-05	53250-06	53250-07	53250-08
60 / 23 1/2"	53260-01	53260-02	53260-03	53260-04	53260-05	53260-06	53260-07	53260-08

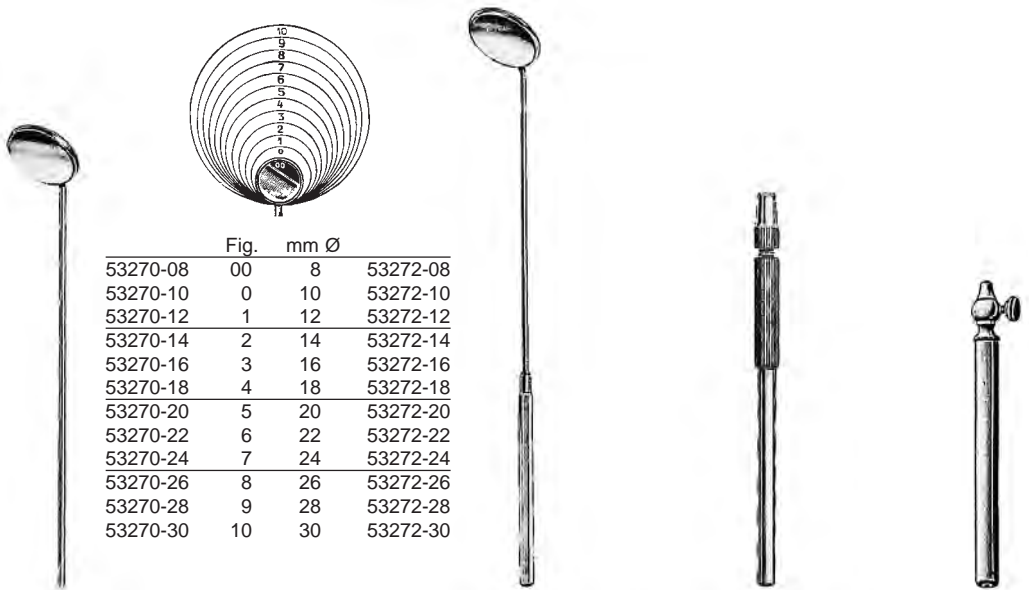

	Fig.	mm Ø	
53270-08	00	8	53272-08
53270-10	0	10	53272-10
53270-12	1	12	53272-12
53270-14	2	14	53272-14
53270-16	3	16	53272-16
53270-18	4	18	53272-18
53270-20	5	20	53272-20
53270-22	6	22	53272-22
53270-24	7	24	53272-24
53270-26	8	26	53272-26
53270-28	9	28	53272-28
53270-30	10	30	53272-30

53270-08 - 53270-30

53272-08 - 53272-30

53274-12

53276-10

Mikro-Rohrschaftzangen
 Micro Laryngeal Forceps
 Pinzas para la micro-cirugía de la laringe
 Pinze ad asta tubolare per microchirurgia

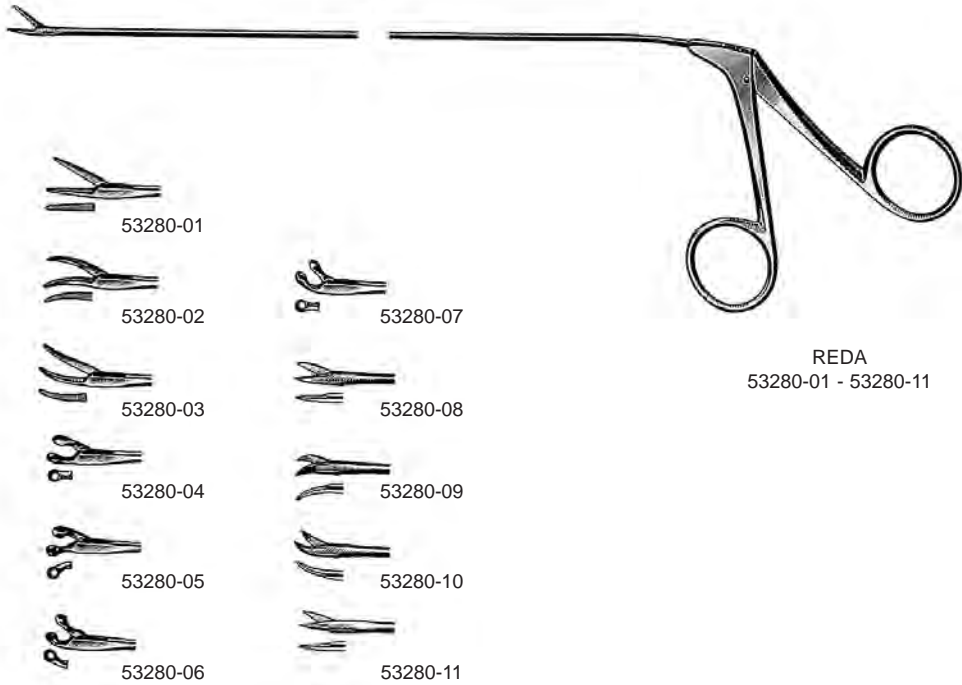

REDA
 53280-01 - 53280-11

REDA Mikro-Rohrschaftzangen 22 cm (8 3/4")

- 53280-01 gerieftes Maul, gerade 1,5 x 10 mm
- 53280-02 gerieftes Maul, links gebogen 1,5 x 8,5 mm
- 53280-03 gerieftes Maul, rechts gebogen 1,5 x 8,5 mm
- 53280-04 Löffelmaul, gerade 2,5 mm
- 53280-05 Löffelmaul, links abgewinkelt 2,5 mm
- 53280-06 Löffelmaul, rechts abgewinkelt 2,5 mm
- 53280-07 Löffelmaul, aufwärts abgewinkelt 2,5 mm
- 53280-08 Schere, gerade, vertikal
- 53280-09 Schere, links gebogen
- 53280-10 Schere, rechts gebogen
- 53280-11 Schere, horizontal schneidend, gerade

REDA Micro-Laryngeal Forceps 22 cm (8 3/4")

- 53280-01 Grasping tip, straight, serrated, 1,5 x 10 mm
- 53280-02 Grasping tip, curved to left, serrated, 1,5 x 8,5 mm
- 53280-03 Grasping tip, curved to right, serrated, 1,5 x 8,5 mm
- 53280-04 Cup forceps, straight, 2,5 mm
- 53280-05 Cup forceps, angled to left, 2,5 mm
- 53280-06 Cup forceps, angled to right, 2,5 mm
- 53280-07 Cup forceps, angled up, 2,5 mm
- 53280-08 Scissors, straight, vertical
- 53280-09 Scissors, curved to left
- 53280-10 Scissors, curved to right
- 53280-11 Scissors, straight, horizontal

REDA Pinza microlaringea 22 cm (8 3/4")

- 53280-01 boca estriada recta 1,5 x 10 mm
- 53280-02 boca estriada curva a la izquierda 1,5 x 8,5 mm
- 53280-03 boca estriada curva a la derecha 1,5 x 8,5 mm
- 53280-04 boca redonda cortante recta 2,5 mm Ø
- 53280-05 boca redonda cortante angulada al la izquierda 2,5 mm Ø
- 53280-06 boca redonda cortante angulada a la derecha 2,5 mm Ø
- 53280-07 boca redonda cortante angulada hacia arriba 2,5 mm Ø
- 53280-08 Tijera recta corte vertical
- 53280-09 Tijera curva a la izquierda
- 53280-10 Tijera curva a la derecha
- 53280-11 Tijera recta corte horizontal

REDA Pinze ad asta tubolare per microchirurgia 22 cm (8 3/4")

- 53280-01 morsi zigrinati, retti, 1,5 x 10 mm
- 53280-02 morsi zigrinati, curvi a sinistra, 1,5 x 8,5 mm
- 53280-03 morsi zigrinati, curvi a destra, 1,5 x 8,5 mm
- 53280-04 morsi a forma di cucchiaio rotondo retto, 2,5 mm
- 53280-05 morsi a forma di cucchiaio rotondo angolati a sinistra, 2,5 mm
- 53280-06 morsi a forma di cucchiaio rotondo angolati a destra, 2,5 mm
- 53280-07 morsi a forma di cucchiaio rotondo angolati in alto, 2,5 mm
- 53280-08 forbici, rette, taglio verticale
- 53280-09 forbici, curve a sinistra
- 53280-10 forbici, curve a destra
- 53280-11 forbici, rette, taglio orizzontale

Instrumente für Tracheotomie
 Instruments for tracheotomy
 Instrumentos tracheotomia
 Strumenti per la tracheotomia

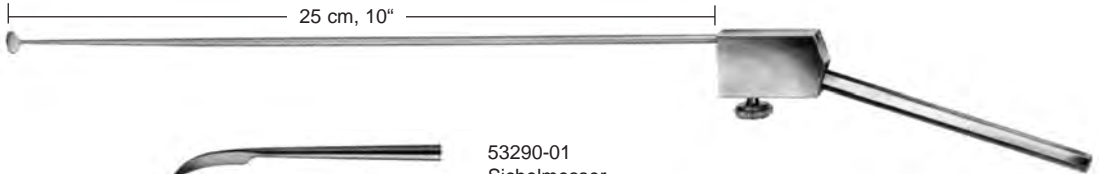

53290-01
 Sichelmesser
 micro-laryngeal sickle
 microlaringeo cuchillo de hoz
 Coltello falciato



53290-02
 Schälmesser, quer, oval
 micro-laryngeal separador oval, horizontal
 microlaringeo separador ovalado, horizontal
 Seperatore ovale verticale



53290-03
 Schälmesser, längs, oval
 micro-laryngeal separador oval, vertical
 microlaringeo separador ovalado, vertical
 Seperatore ovale orizzontale



53290-04
 Schälmesser, 45° abgewinkelt
 micro-laryngeal round cutting knife, 45° angled
 microlaringeo cuchillo para cortes redondos, 45° angulado
 Seperatore angolato 45°



53290-05
 Häkchen, 90° gebogen stumpf
 micro-laryngeal hook 90° angled, blunt
 microlaringeo ganchito 90° angulado, romo
 Uncino angolato 90° smusso



53290-06
 Häkchen, 30° retrograd gebogen
 micro-laryngeal probe, 30° backwards curved blunt with button
 microlaringeo ganchito, 30° curvo retrogrado
 Uncino angolato retrogrado 30°



53290-07
 Fadengabel
 micro-laryngeal ligatore adjuster
 microlaringeo horquilla de hilos
 Forchetta da sutura

53290-08
 Handgriff für Stabinstrumente
 Handle for microlaryngeal instruments
 Mango para microlaringeos instrumentos
 Manico per strumenti microlaringei



Tracheal Dilatatore, Trachealhaken, Tracheal-Wundspreizer

Trachea Dilators, Trachea hooks, Trachel Retractors

Dilatadores para la tráquea, Ganchos para traqueotomía, Retractor traqueal

Dilatatori per tracheotomia, Ganci per tracheotomia, Divaricatori tracheali

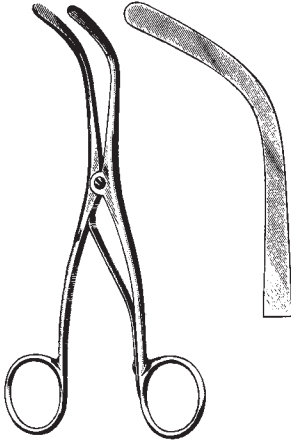

TROUSSEAU-BABY
55111-13 13 cm, 5 $\frac{1}{8}$ "

TROUSSEAU
55111-14 14 cm, 5 $\frac{1}{2}$ "

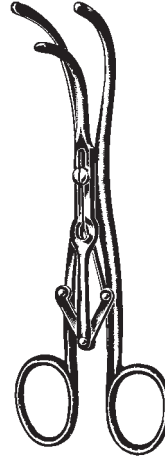

LABORDE
55113-14
14 cm, 5 $\frac{1}{2}$ "



BOSE
55115-07
7 cm, 2 $\frac{3}{4}$ "



JACKSON
55116-15
15 cm, 6"



JACKSON
55117-17
17 cm, 6 $\frac{3}{4}$ "

Trachealhaken, Kanüle
 Trachea Hooks, Tubes
 Ganchos para traqueotomía, Cánula
 Ganci per tracheotomia, Cannule



ITERSON
 55118-16 - 55119-16
 16 cm, 6 1/4"



NEWS
 55120-15
 15 cm, 6"

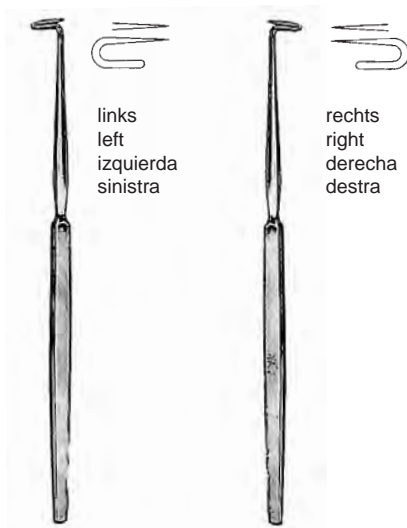

BOSE
 55122-16
 16 cm, 6 1/4"

BOSE
 55124-16
 16 cm, 6 1/4"



WAGENER-MOSHER
 55151-05 5 mm
 55151-07 7 mm
 55151-09 9 mm

Tracheotomie-Besteck
Tracheotomy Set
Estuche para Traqueotomía
Set per Tracheotomia

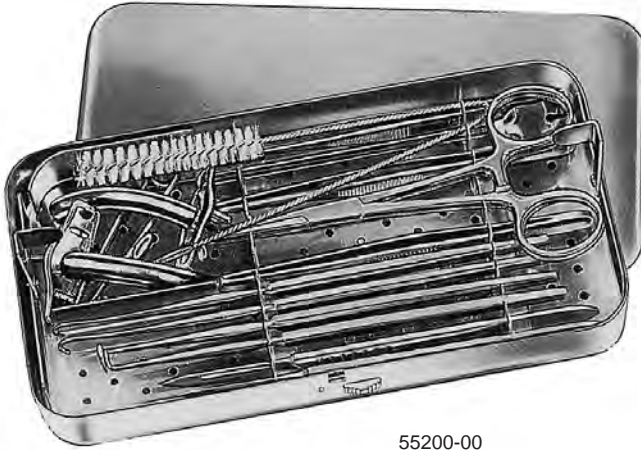

55200-00

Tracheotomie-Besteck

in Metall-Etui, bestehend aus:

- 1 Griff und 1 Klinge, Fig. 20
- 1 Griff und 1 Klinge, Fig. 23
- 1 anat. Pinzette, 13 cm (5 1/8")
- 2 chir. Pinzetten, 13 cm (5 1/8"), 1x2 Zähne
- 2 Pean-Klemmen, 13 cm (5 1/8")
- 1 Hohlsonde, 13 cm (5 1/8")
- 1 Trachealdilatator
- 2 Trachealhäkchen Iterson stumpf
- 1 Trachealhäkchen Bose scharf, links
- 1 Trachealhäkchen Bose scharf, rechts
- 1 Trachealkanüle Luer Standard, Fig. 3
- 1 Trachealkanüle Luer Standard, Fig. 4
- 1 Reinigungsbürste

Tracheotomy Set

in metal case, consisting of:

- 1 Handle with 1 blade, Fig. 20
- 1 Handle with 1 blade, Fig. 23
- 1 Thumb Forceps, 13 cm (5 1/8")
- 1 Tissue Forceps, 13 cm (5 1/8"), 1x2 teeth
- 2 Pean Artery Forceps, 13 cm (5 1/8")
- 1 Grooved Director, 13 cm (5 1/8")
- 1 Trachea Dilator
- 1 Iterson Trachea Retractors, blunt
- 1 Bose Trachea Retractor, sharp, left hand side
- 1 ditto, right hand side
- 1 Luer Trachea Tube, Standard, Fig. 3
- 1 ditto, Fig. 4
- 1 Cleaning Brush

Estuche para Traqueotomía

en estuche de metal, compuesto de:

- 1 Mango con 1 hoja fig. 20
- 1 Mango con 1 hoja fig. 23
- 1 Pinza de disección, 13 cm (5 1/8")
- 1 Pinza de disección, con 1x2 dientes de ratón, 13 cm (5 1/8")
- 2 Pinzas hemostáticas Pean, 13 cm (5 1/8")
- 1 Sonda acanalada, 13 cm (5 1/8")
- 1 Dilatador traqueal
- 2 Iterson separadores traqueales, romos
- 1 Bose separador traqueal, agudo, lado izquierdo
- 1 idem, lado derecho
- 1 Luer Cánula traqueal, modelo standard, Fig. 3
- 1 idem, Fig. 4
- 1 Cepillo de limpieza

Set per tracheotomia

in scatola di metallo, composto da:

- 1 Manico di bisturi con 1 lama fig. 20
- 1 Manico di bisturi con 1 lama fig. 23
- 1 Pinza per dissezione, cm 13 (5 1/8")
- 1 Pinza per dissezione con denti 1x2, cm 13 (5 1/8")
- 2 Pinze emostatiche Pean, cm 13 (5 1/8")
- 1 Sonda scanalata, cm 13 (5 1/8")
- 1 Dilatatore traqueale
- 2 Uncini tracheali Iterson, smussi
- 1 Uncino tracheale Bose, acuto, lato sinistro
- 1 item, lato destro
- 1 Cannula tracheale Luer standard, Fig. 3
- 1 item, Fig. 4
- 1 Spazzolino per pulire

Tracheal-Kanülen, Schilddrüsenhaken, Sonde, Kropffabzange, Muskelklemme
 Tracheal Tubes, Thyroid Gland Retractor, Directors-Enucleators, Goitre Seizing Forceps, Muscular Clamp
 Cánulas traqueales, Separador para la glándula tiroidea, Sondas acanaladas,
 Pinza para coger el bocio, Pinza-clamp para músculos
 Cannule tracheali, Divaricatori per la tiroide, Sonde, Pinze per gozzo, Pinza muscolare



Fig.	Ø mm	Länge des Außenrohrs Length of outer tube Largo de la cánula exterior Lunghezza del tubo esterno
0	4	45
1	5	50
2	6	55
3	7	60
4	8	65
5	9	70
6	10	75
7	11	80
8	12	85
9	13	90

LUER
 Neusilber
 German silver
 alpaca
 argentone
 45-90 mm
 55220-04
 55220-05
 55220-06
 55220-07
 55220-08
 55220-09
 55220-10
 55220-11
 55220-12
 55220-13

CHEVALIER-JACKSON
 Neusilber
 German silver
 alpaca
 argentone
 45-90 mm
 55240-04
 55240-05
 55240-06
 55240-07
 55240-08
 55240-09
 55240-10
 55240-11
 55240-12
 55240-13

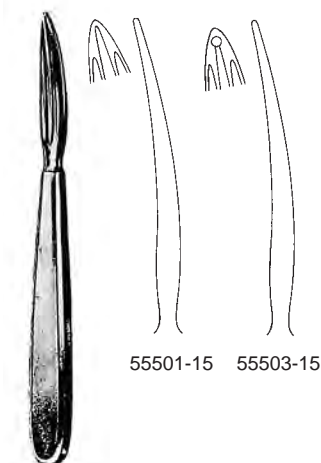

KOCHER
 55501-15 - 55503-15
 15 cm, 6"



SCHOENBORN
 55511-21
 21 cm, 8 1/4"



LAHEY
 55520-15 15 cm, 6"
 55520-20 20 cm, 8"

MASTIN
 55523-17
 17 cm, 6 3/4"

Rippenscheren, Sternummeißel
 Rib Shears
 Costótomos
 Costotomi

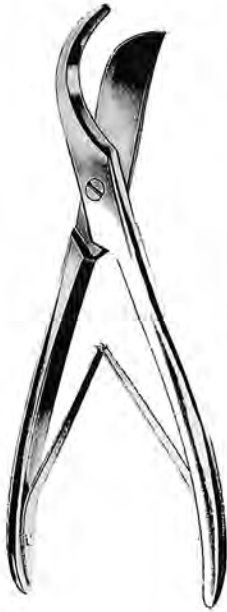

57102-23
 23 cm, 9"



57105-22
 22 cm, 8 3/4"



GLUCK
 57107-22
 22 cm, 8 3/4"

mit ziehendem Schnitt
 with eccentric sliding blade
 con hoja de retroacción
 con lama di retroazione



STILLE
 57111-21
 21 cm, 8 1/4"



CORYLLOS
 57123-35
 35 cm, 13 3/4"



CORYLLOS
 57125-35
 35 cm, 13 3/4"

Rippenscheren, Sternumscheren
Rib Shears, Sternum Scissors
Costótomos, Tijeras de esternón
Costotomi, Forbici per sterno



BETHUNE
57126-34
34 cm, 13 1/2"



SAUERBRUCH
57131-26
26 cm, 10 1/4"



GIERTZ-STILLE
57137-27
27 cm, 10 1/2"



SCHUMACHER
57138-21
21 cm, 8 1/4"



SAUERBRUCH-FREY
57141-36
36 cm, 14.2"

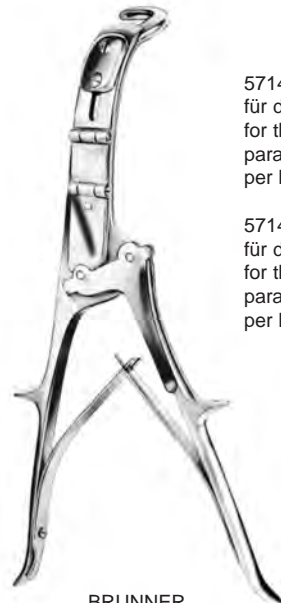

BRUNNER
57146-28 - 57147-28
28 cm, 11"

57146-28
für die rechte Hand
for the right hand
para la mano derecha
per la mano destra

57147-28
für die linke Hand
for the left hand
para la mano izquierda
per la mano sinistra

Rippensperrer
Rib Spreaders
Separadores costales
Divaricatori costali



rostfrei
stainless
acero inoxidable
inossidabile

FINOCHIETTO

	a	b	c
	mm	mm	mm
57210-16	38	44	160
57210-20	52	62	200
57210-25	65	85	250

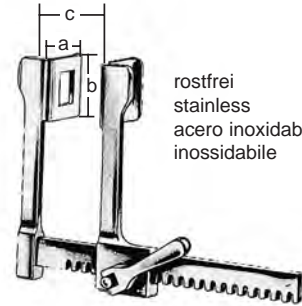

rostfrei
stainless
acero inoxidable
inossidabile

FINOCHIETTO-BABY

	a	b	c
	mm	mm	mm
57214-75	18	20	75

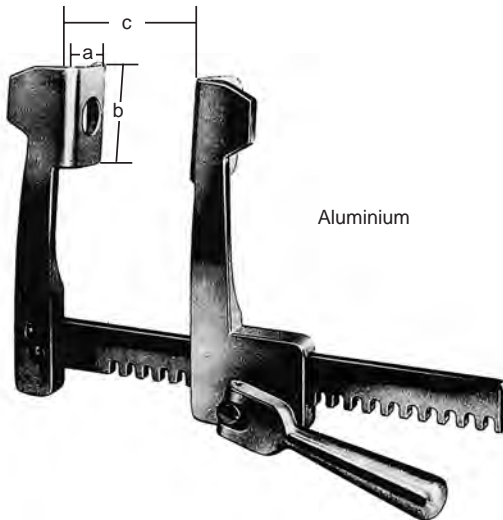

Aluminium

FINOCHIETTO

	a	b	c
	mm	mm	mm
57230-13	38	44	135
57230-17	52	62	175
57230-18	85	65	175

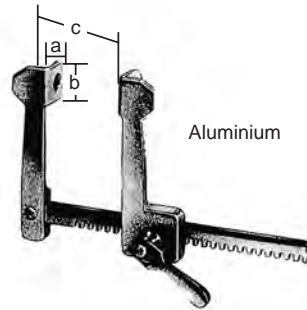

Aluminium

FINOCHIETTO-BABY

	a	b	c
	mm	mm	mm
57234-75	15	15	75

Rippensperrer
Rib Spreaders
Separadores costales
Divaricatori costali

FINOCHIETTO-BURFORD

	a	b	c
	mm	mm	mm
57236-20	65	62	200
	47	62	
57236-25	65	62	250
	47	62	
57236-30	65	62	300
	47	52	



rostfrei
stainless
acero inoxidable
inossidabile

Erwachsene
Adult Size
para adultos
per adulti

FINOCHIETTO-BURFORD

	a	b	c
	mm	mm	mm
57242-20	47	62	200
	65	62	
57242-25	47	62	250
	65	62	
57242-30	47	62	300
	65	62	



Aluminium

Kinder
Child Size
para niños
per bambini

FINOCHIETTO-BURFORD

	a	b	c
	mm	mm	mm
57244-13	34	42	135
	48	42	



Aluminium

Rippensperrer
Rib Spreaders
Separadores costales
Divaricatori costali

FINOCHIETTO			
	a	b	c
	mm	mm	mm
57245-13	14	14	120

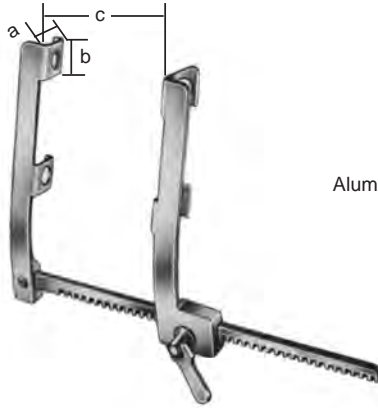

Aluminium

MORSE			
	a	b	c
	mm	mm	mm
57246-16	17	22	160

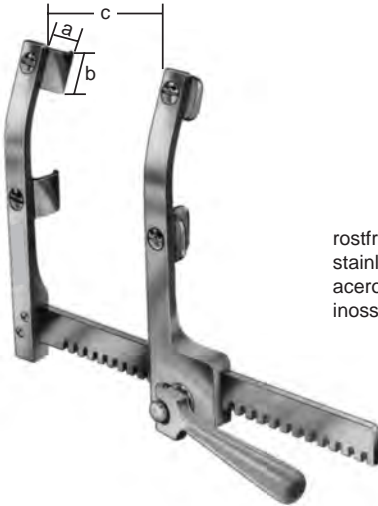

rostfrei
stainless
acero inoxidable
inossidabile

MORSE-FAVALORO			
	a	b	c
	mm	mm	mm
57246-21	19	27	210



rostfrei
stainless
acero inoxidable
inossidabile

Rippensperrer
Rib Spreaders
Separadores costales
Divaricatori costali

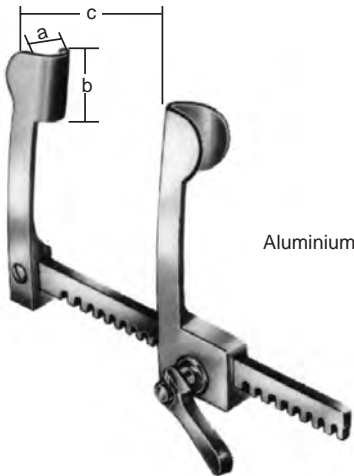

Aluminium

COOLEY-NEONATAL

	a	b	c
	mm	mm	mm
57247-95	12	16	95

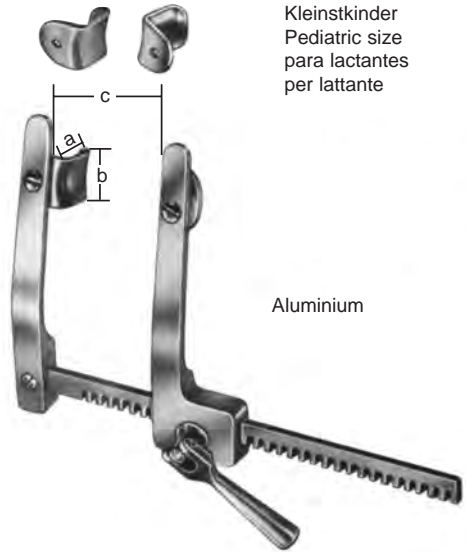

Kleinstkinder
Pediatric size
para lactantes
per lattante

Aluminium

COOLEY

	a	b	c
	mm	mm	mm
57249-01	10	14	90

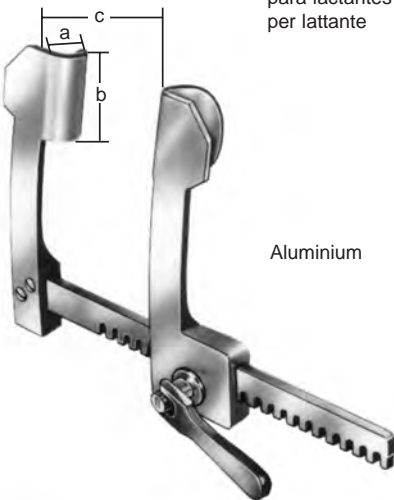

Kleinstkinder
Pediatric size
para lactantes
per lattante

Aluminium

COOLEY

	a	b	c
	mm	mm	mm
57248-14	15	30	140



Kleinstkinder
Pediatric size
para lactantes
per lattante

Aluminium

COOLEY

	a	b	c
	mm	mm	mm
57249-02	10	14	90

Rippensperrer rostfrei
 Rib Spreaders stainless
 Separadores costales acero inoxidable
 Divaricatori costali inossidabile

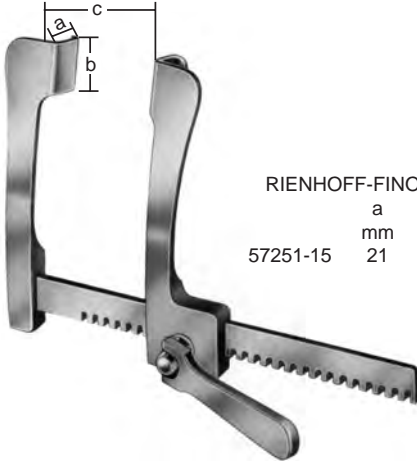

	a	b	c
	mm	mm	mm
57251-15	21	26	150

rostfrei
 stainless
 acero inoxidable
 inossidabile



	a	b	c
	mm	mm	mm
57252-19	27	100	190

rostfrei
 stainless
 acero inoxidable
 inossidabile

Rippensperrer rostfrei
 Rib Spreaders stainless
 Separadores costales acero inoxidable
 Divaricatori costali inossidabile

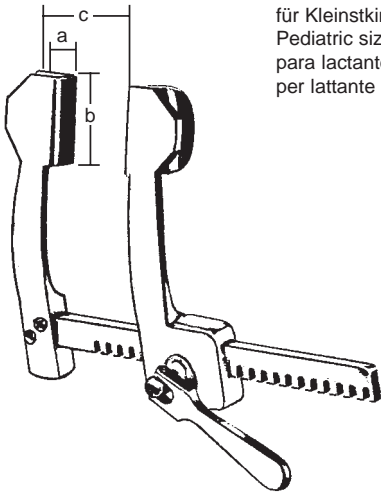

für Kleinstkinder
 Pediatric size
 para lactantes
 per lattante

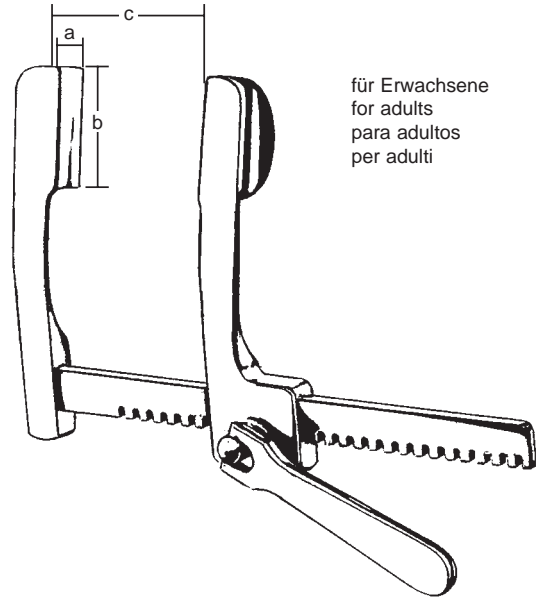

für Erwachsene
 for adults
 para adultos
 per adulti

COOLEY

	a	b	c
	mm	mm	mm
57260-02	16	30	105
57260-03	21	44	150

COOLEY

	a	b	c
	mm	mm	mm
57260-04	37	49	200



HAIGHT

	a	b	c	h
	mm	mm	mm	mm
57260-06	30	30	90	65
57260-09	30	30	90	90



TUFFIER

	a	b	c
	mm	mm	mm
57264-16	50	45	165

Laminektomie-Sperrer
Laminectomy-Retractor
Separadores para laminectomía
Divaricatori Laminectomia

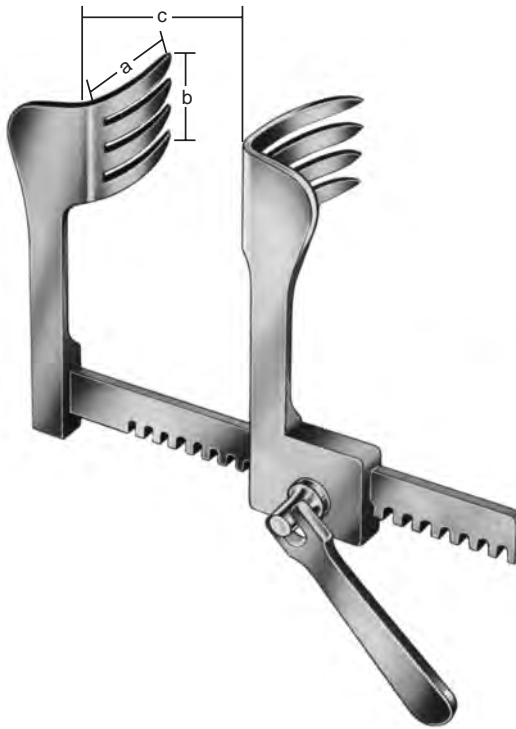

CHERRY

	a	b	c
	mm	mm	mm
57266-13	44	70	135

Thoraxsperrer, Rippenkontraktoren, Lungen spatel
 Thoracic retractor, Rib Contractors, Lung Spatulas
 Separador torácico, Aproximadores para costillas, Espátulas pulmonares
 Divaricatore per il torace, Approssimatori costali, Spatole per polmone



57270-80
 Sperrer allein
 Retractor only
 Separador solo
 Divaricatore solo

MERCEDES compl.
 57270-00

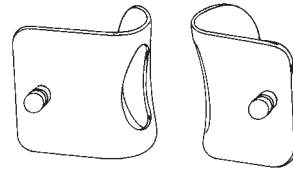

57270-65
 42x65 mm

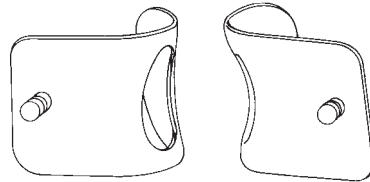

57270-75
 75x75 mm

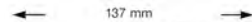

57288-30
 30 cm, 11 3/4"



ALLISON
 57289-32
 32 cm, 12 3/4"

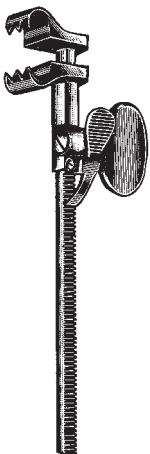

BAILEY-BABY
 57283-14
 14 cm, 5 1/2"

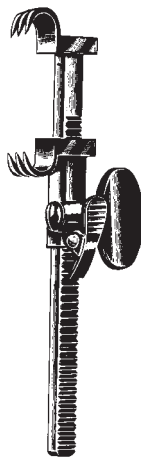

BAILEY
 57284-16
 16 cm, 6 1/4"



BAILEY-GIBBON
 57286-16
 16 cm, 6 1/4"

Lungenfaßzange, Bronchusklemmen
 Lung Grasping Forceps, Bronchus Forceps
 Pinzas para coger el pulmón, Pinzas clamps bronquiales
 Pinze per afferrare il polmone, Pinze per bronchi

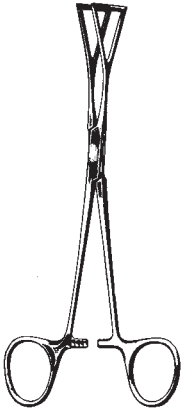

LOVELACE
 57290-20
 20 cm, 8"

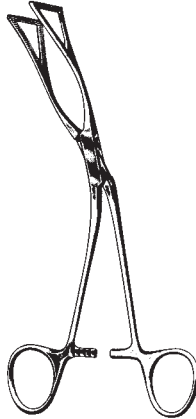

LOVELACE
 57291-20
 20 cm, 8"



HARRINGTON
 57301-30
 30,5 cm, 12"

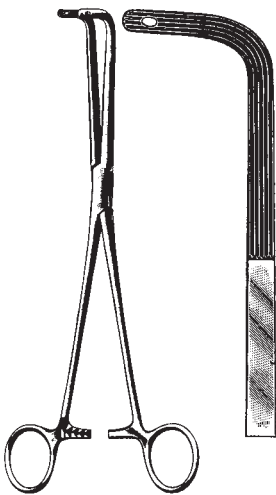

FINOCIETTO
 57307-24
 24 cm, 9 1/2"

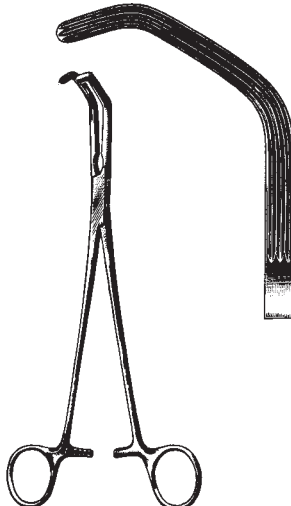

PRICE-THOMAS
 57309-22
 22 cm, 8 3/4"

Zähne links
 tooth left
 dientes izquierda
 denti sinistro
 57311-22



PRICE-THOMAS
 22 cm, 8 3/4"

rechts
 right
 derecha
 destro
 57313-22

Bronchusklemmen, Gefäßklemmen
Bronchus Forceps, Blood Vessel Clamps
Pinzas clamps bronquiales, Pinzas-clamps para vasos
Pinze per bronchi, Pinze cardiovascolari

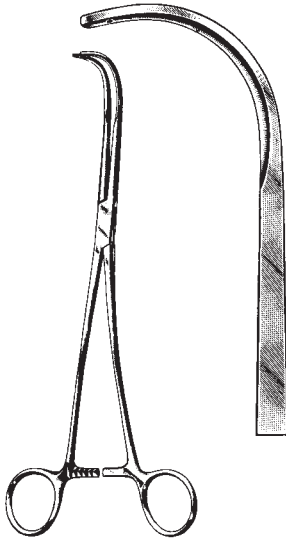

57321-23

SEMB
23 cm, 9"

57323-23

SATINSKY
57325-15
15 cm, 6"SATINSKY
57327-26 - 57329-26
26 cm, 10 1/4"

Fig. 1 57327-26

Fig. 2 57329-26

Coarctations-Klemmen
 Coarctation clamps
 Pinzas clamps para coartación
 Pinza per coartazione

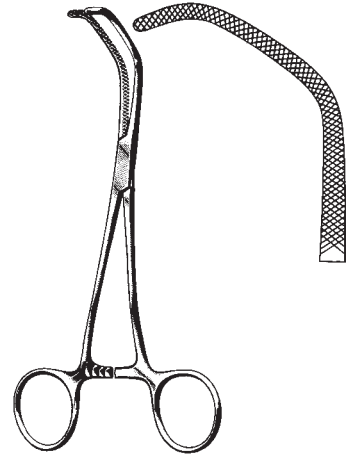
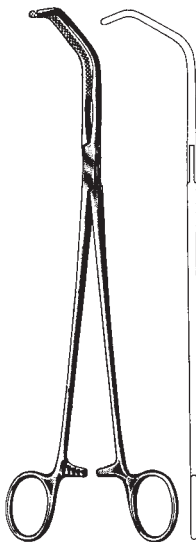
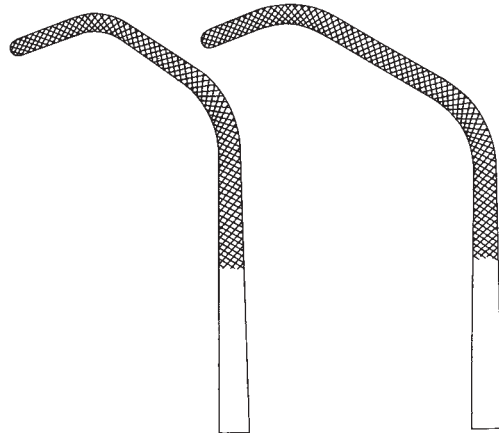
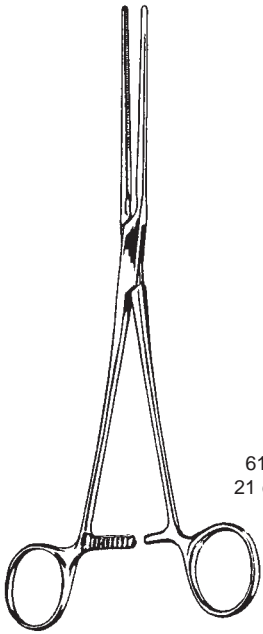

POTTS
 61000-21 - 61000-22



61000-21
 21 cm, 8 1/4"



61000-22
 22 cm, 8 3/4"

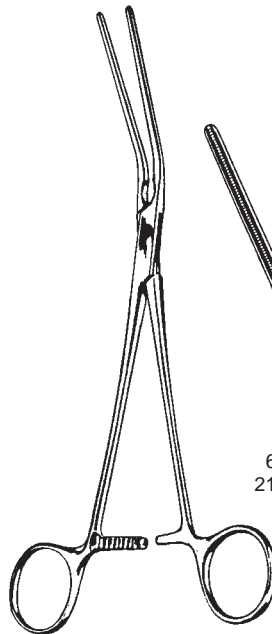

POTTS
 61001-21 - 61001-22



61001-21
 21 cm, 8 1/4"



61001-22
 22 cm, 8 3/4"

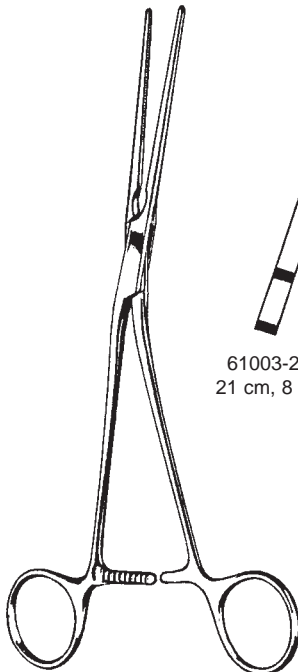

POTTS
 61003-21 - 61003-22

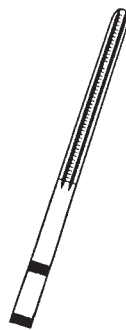

61003-21
 21 cm, 8 1/4"

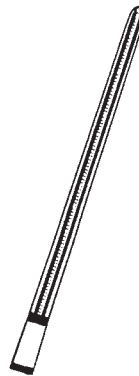

61003-22
 22 cm, 8 3/4"



Anastomosens-Klemmen, Präparier- und Ligaturklemmen
 Anastomosis clamps, Dissecting and ligature forceps
 Pinzas clamps para anastomosis, Pinzas para preparaciones y ligaduras
 Pinze per anastomosi, Pinze per preparazioni e legature

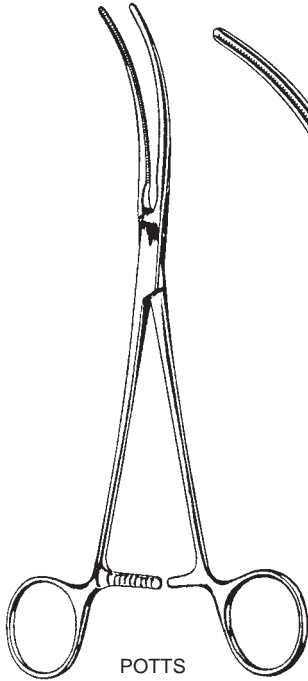

POTTS
 61005-22
 22 cm, 8 3/4"

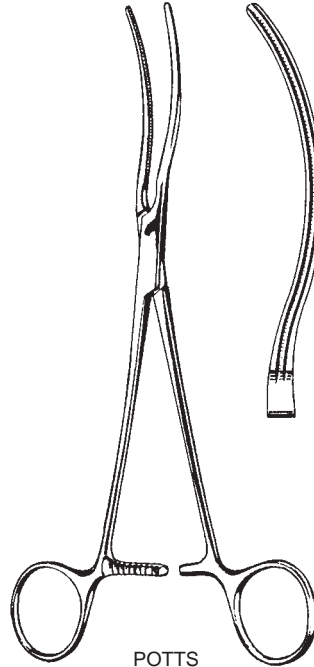

POTTS
 61007-22
 22 cm, 8 3/4"

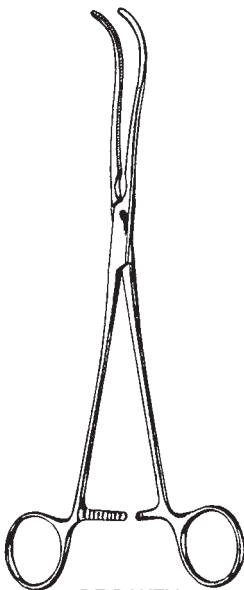

DE BAKEY
 61008-19 - 61008-23



61008-19
 19 cm, 7 1/2"



61008-23
 23 cm, 9"

Peripheral-Gefäßklemmen
Peripheral vascular clamps
Pinzas-clamps para vasos periféricos
Pinze vascolari periferici

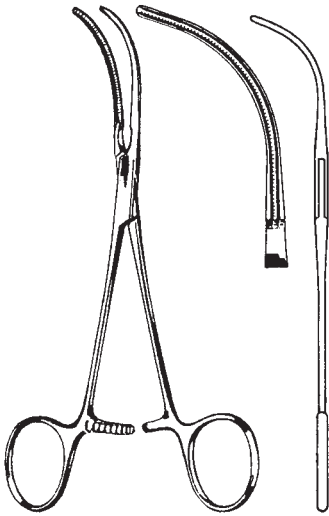

DE BAKEY
61009-16
16 cm, 6 1/4"

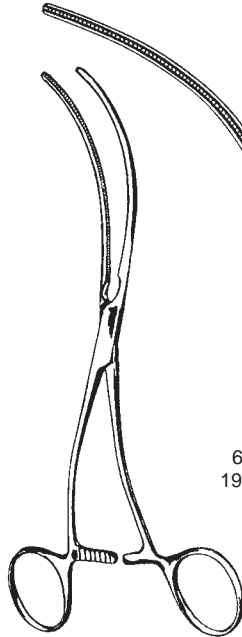

61011-19
19 cm, 7 1/2"

DE BAKEY
61011-19 - 61011-20

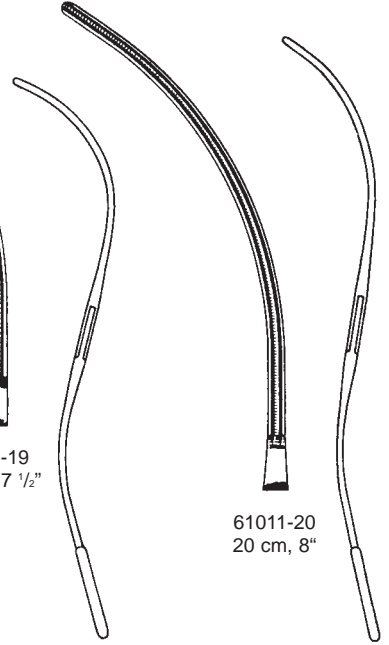

61011-20
20 cm, 8"

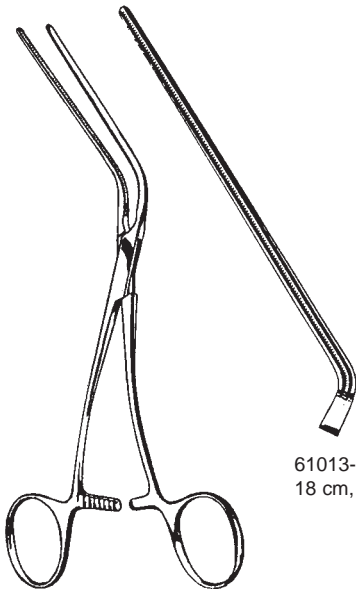

61013-18
18 cm, 7"

LELAND-JONES
61013-18 - 61013-20



61013-19
19 cm, 7 1/2"

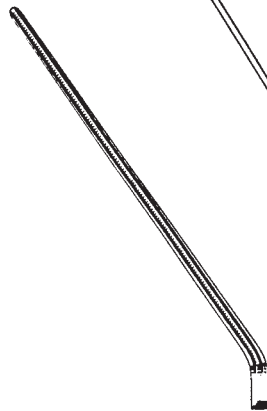

61013-20
20 cm, 8"

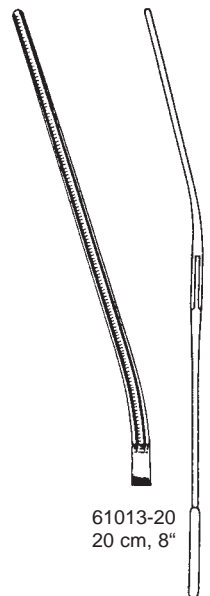

Mehrzweck-Gefäßklemme
Multi purpose Vascular Clamps
Pinzas vasculares de usos multiples
Pinze vascolari universali

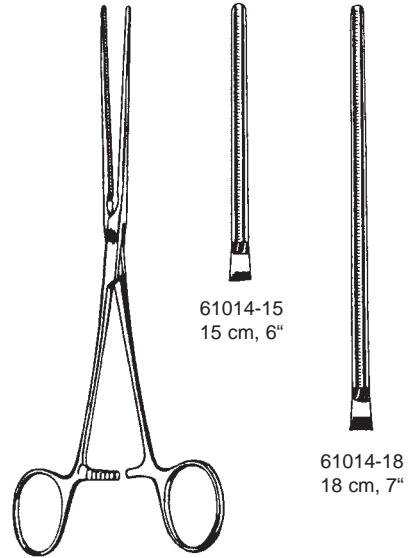

61014-15
15 cm, 6"

61014-18
18 cm, 7"

BAINBRIDGE
61014-15 - 61014-18

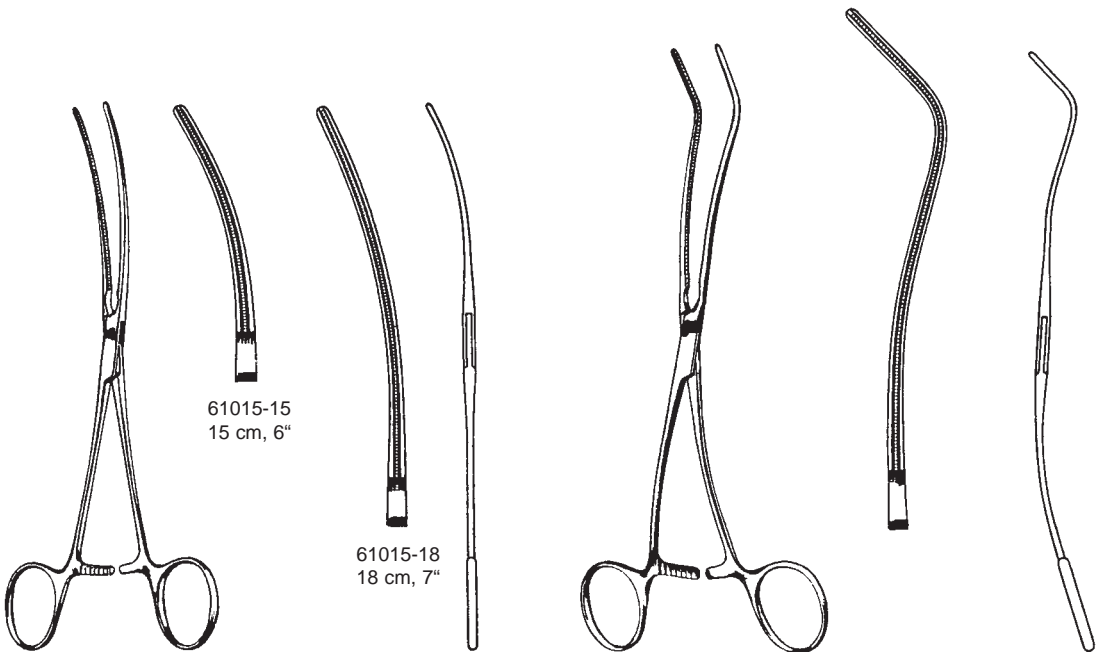

61015-15
15 cm, 6"

61015-18
18 cm, 7"

BAINBRIDGE
61015-15 - 61015-18

DE BAKEY
61016-20
20 cm, 8"

Aorta-Aneurysmaklemmen
Aortic aneurysm clamps
Pinzas-clamps para aneurisma de la aorta
Pinze per aneurisma aorta



61017-26
26 cm, 10 1/4"

61017-27
27 cm, 10 1/2"

61017-31
31 cm, 12 1/4"

61017-33
33 cm, 13"

DE BAKEY
61017-26 - 61017-33

Aorta-Aneurysmaklemmen
Aortic aneurysm clamps
Pinzas-clamps para aneurisma de la aorta
Pinze per aneurisma aorta



DE BAKEY
61018-28
28 cm, 11"

Aorta-Aneurysmaklemmen
 Aortic aneurysm clamps
 Pinzas-clamps para aneurisma de la aorta
 Pinze per aneurisma aorta

Draufsicht
 Top view
 Vista de arriba
 Vista da vicino

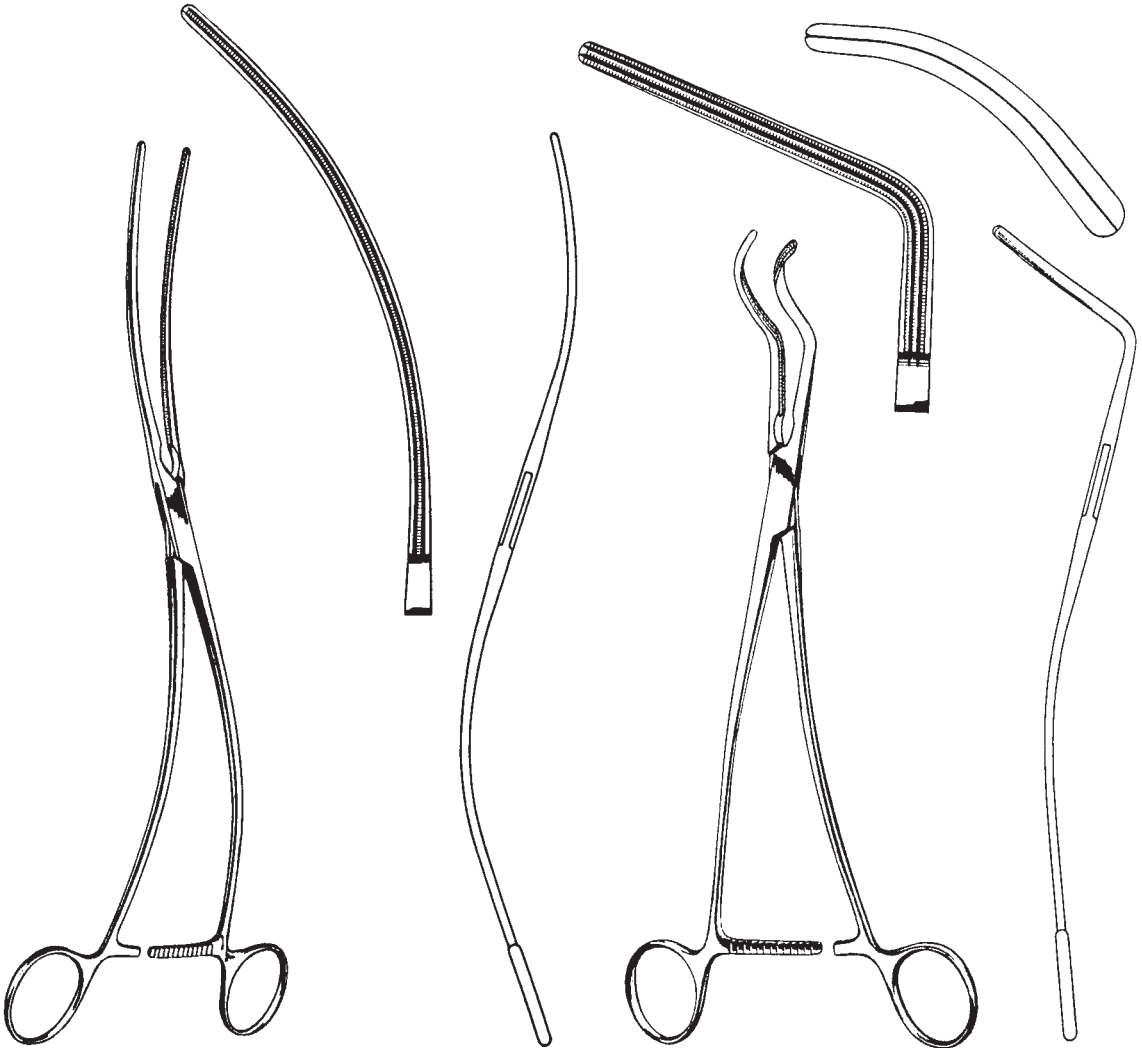

DE BAKEY
 61019-30
 30 cm, 11 ³/₄"

DE BAKEY
 61020-27
 27 cm, 10 ¹/₂"

Ligaturklemmen, Aortaklemme
Ligature clamps, Aortic clamp
Pinzas clamps para ligaduras y la aorta
Pinze per legature e aorta

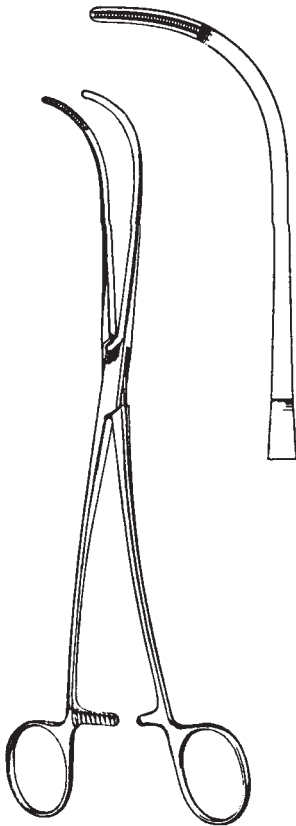

DE BAKEY-SEMB
61021-24
24 cm, 9 1/2"

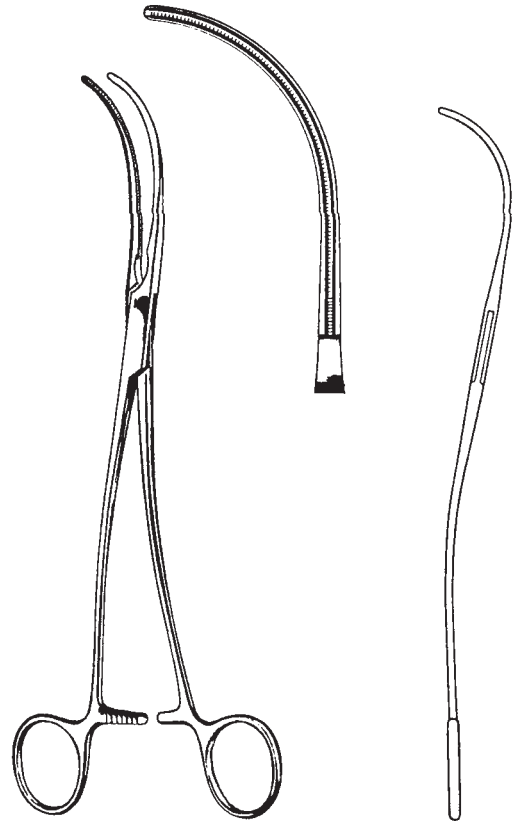

DE BAKEY
61022-24
24 cm, 9 1/2"

Ligaturklemme, Aortaklemme
Ligature clamp, Aortic clamp
Pinzas clamps para ligaduras y la aorta
Pinze per legature e aorta

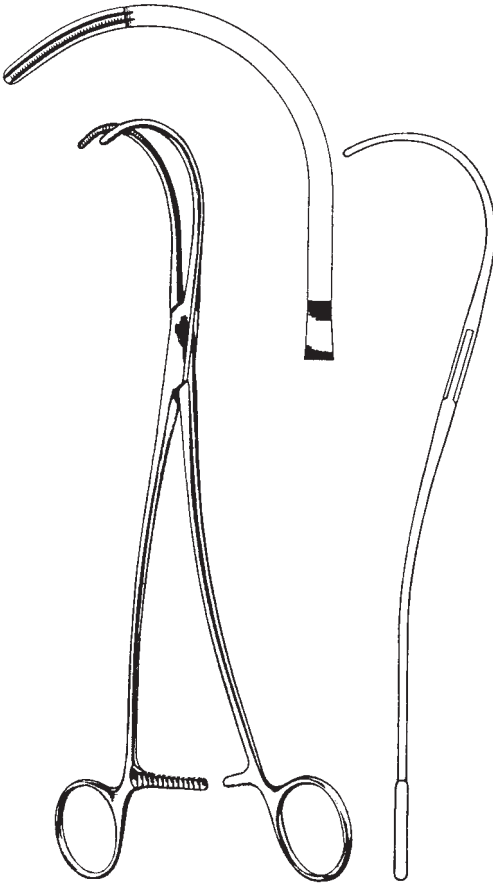

DE BAKEY
61023-25
25 cm, 10"

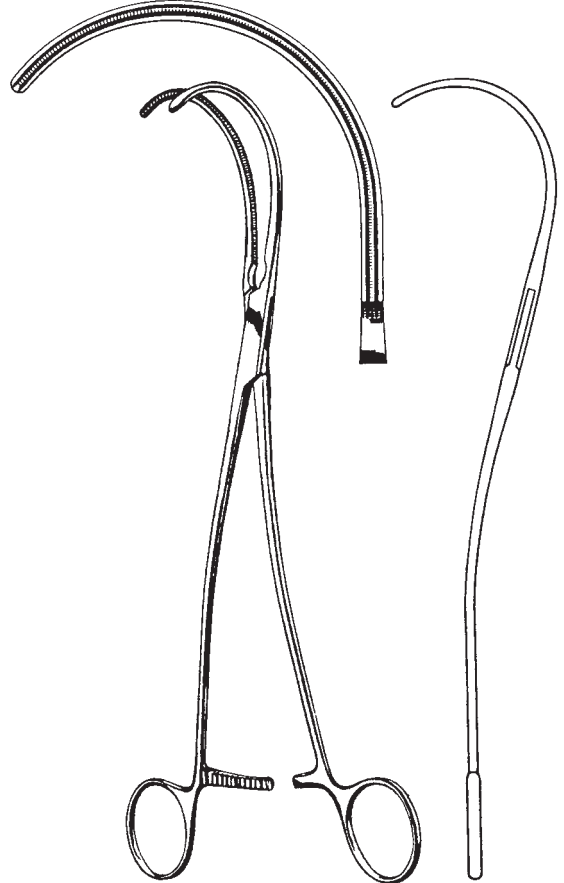

DE BAKEY
61023-26
26 cm, 10 1/4"

Aortaklemmen
Aortic clamps
Pinzas-clamps para la aorta
Pinze per aorta

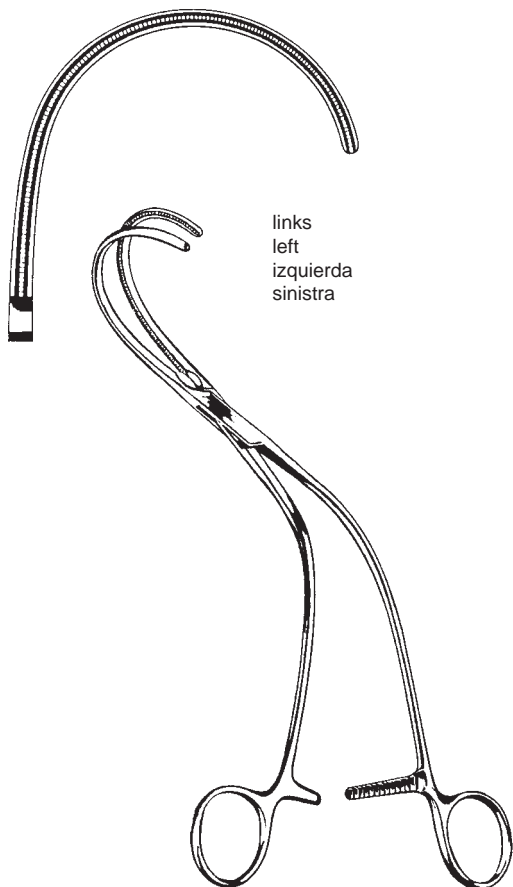

links
left
izquierda
sinistra

WEBER
61024-01
26 cm, 10 1/4"

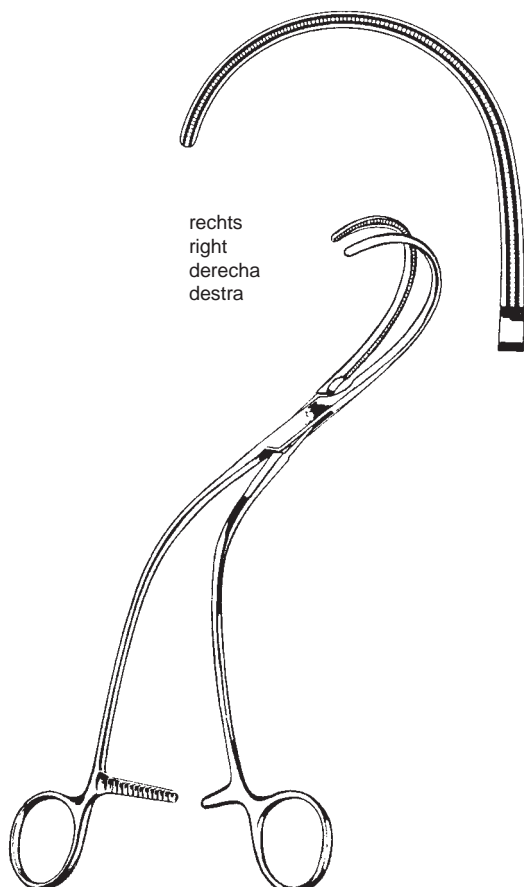

rechts
right
derecha
destra

WEBER
61024-02
26 cm, 10 1/4"

Tangentialklemmen
 Tangential occlusion clamps
 Pinzas-clamps para oclusión tangencial
 Pinze per occlusione tangenziale

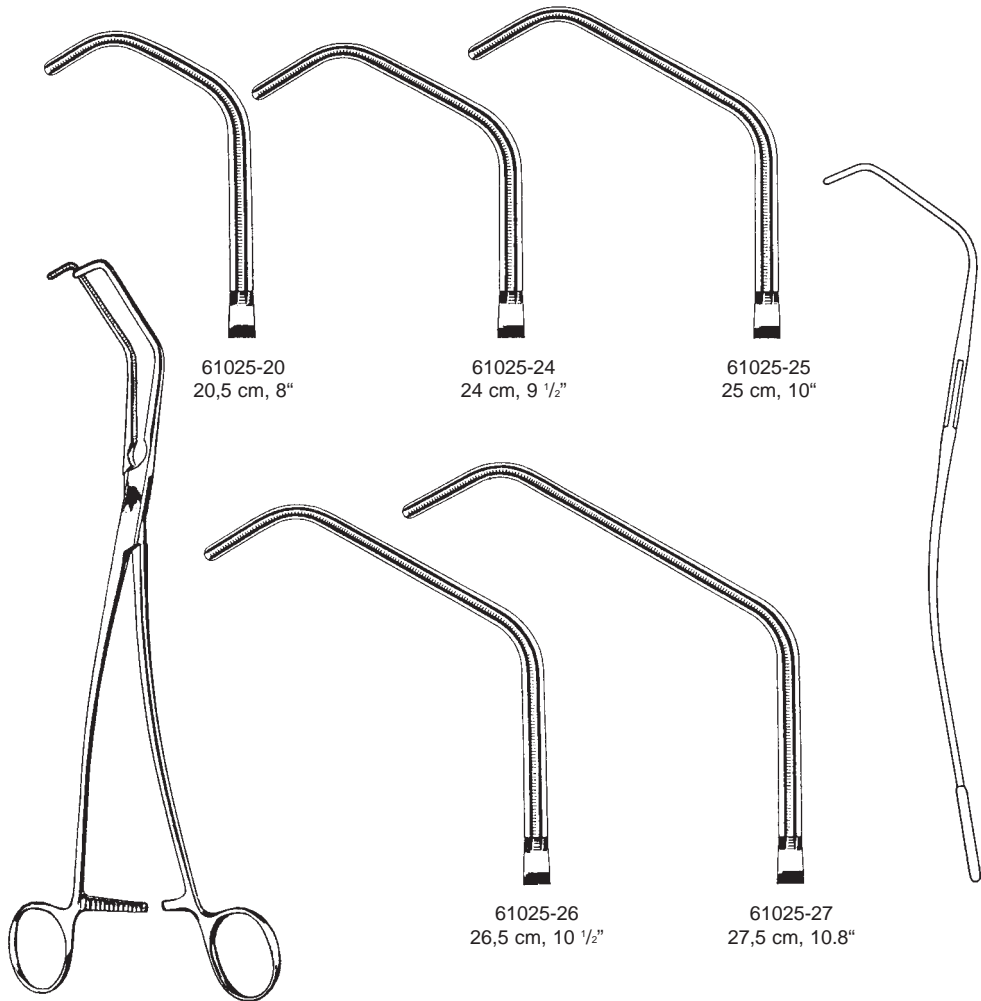

61025-20
20,5 cm, 8"

61025-24
24 cm, 9 1/2"

61025-25
25 cm, 10"

61025-26
26,5 cm, 10 1/2"

61025-27
27,5 cm, 10.8"

DE BAKEY-SATINSKY
61025-20 - 61025-27

Aurikelklemmen
Auricle clamps
Pinza-clamps auriculares
Pinza auricula



HARKEN
61026-01 - 61026-04

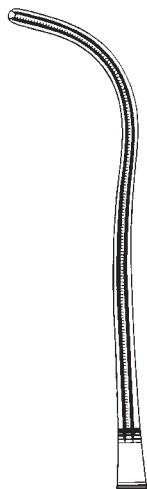

61026-01
24 cm, 9 1/2"

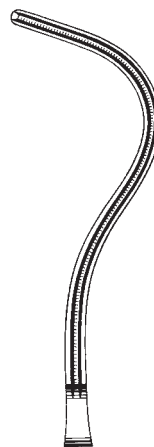

61026-02
24 cm, 9 1/2"

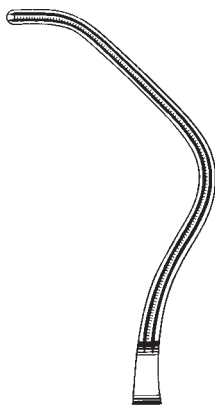
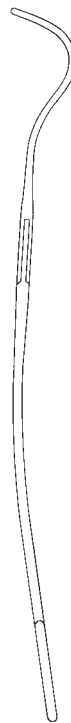

61026-03
24 cm, 9 1/2"

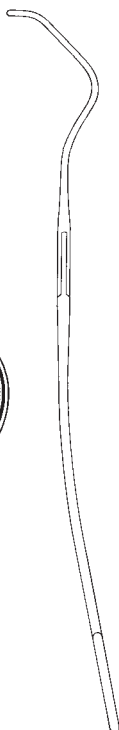

61026-04
24 cm, 9 1/2"

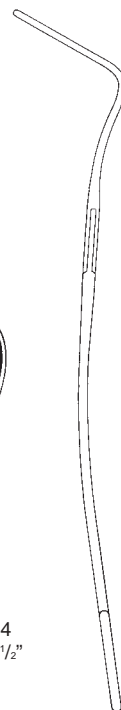

Bronchusklemmen
Bronchus clamp
Pinzas-clamps bronquiales
Pinze per bronchi

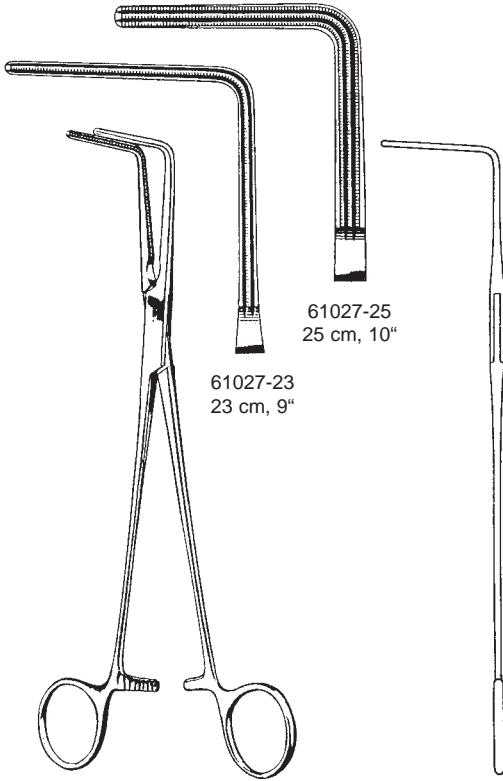

61027-25
25 cm, 10"
61027-23
23 cm, 9"

LEES
61027-23 - 61027-25

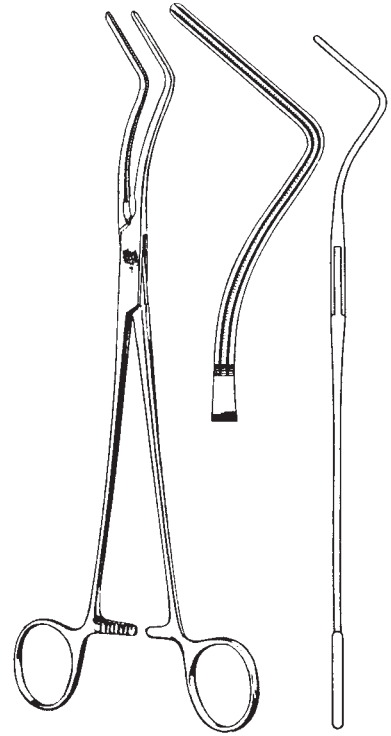

LEES
61029-25
25 cm, 10"

Aorta-Anastomosenklemmen
Aortic anastomosis clamps
Pinzas-clamps para anastomosis
Pinze anastomosi aorta

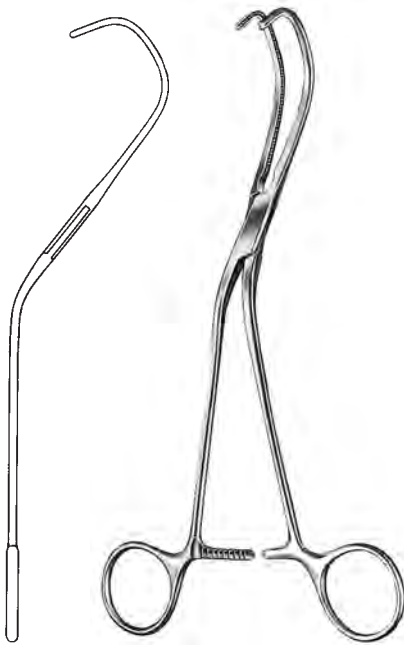

LAMBERT-KAY
21 cm, 8 1/4"
61030-21 - 61030-22



61030-22

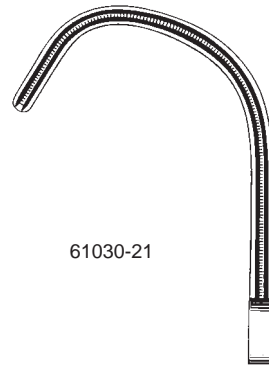

61030-21



DE BAKEY
61031-17
17 cm, 6 3/4"

Aorta - und Aneurysmaklemme
 Aortic- and Aneurysm clamps
 Pinzas aórticas y para aneurisma
 Pinze per aorta e per aneurisma

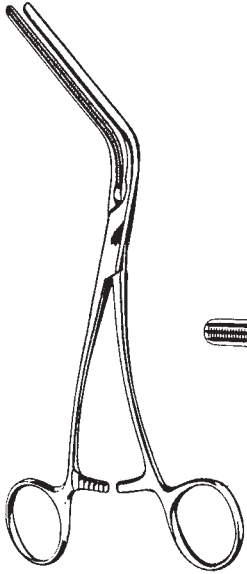

MORRIS-DE BAKEY
 61032-18 - 61032-25

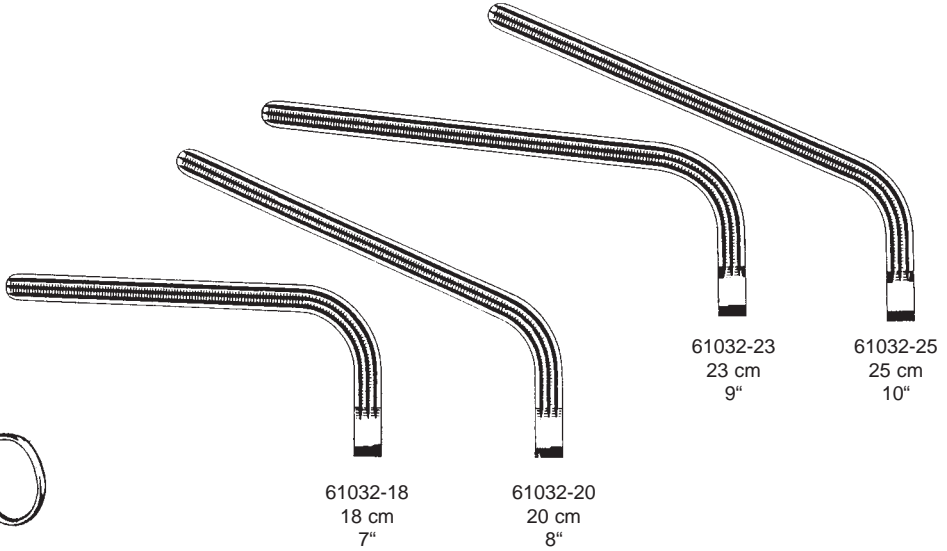

DE BAKEY-BAHNSON
 61033-23 - 61033-25

Coarctations-Klemmen
 Coarctation clamps
 Pinzas-clamps para coartación
 Pinze per coartazione

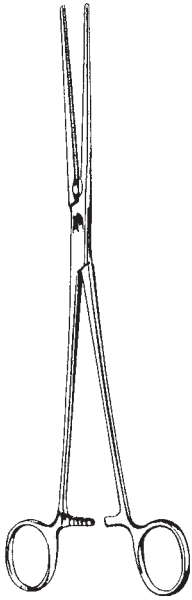

DE BAKEY
 61034-21 - 61034-31



61034-21
 21,5 cm
 8 1/2"



61034-23
 23 cm
 9"



61034-27
 27 cm
 10 1/2"



61034-31
 31,5 cm
 12 1/2"

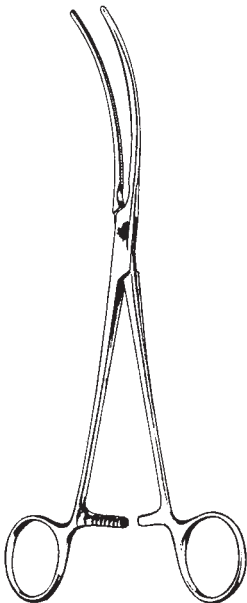

DE BAKEY
 61035-21 - 61035-31



61035-21
 21,5 cm
 8 1/2"



61035-23
 23 cm
 9"

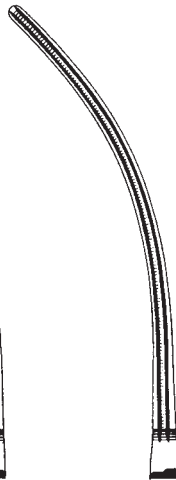

61035-27
 27 cm
 10 1/2"

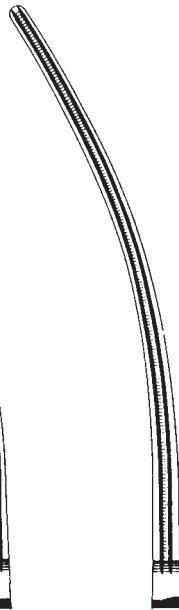

61035-31
 31 cm
 12 1/4"

Mehrzweckklemmen
 Multi purpose clamps
 Pinzas-clamps para usos varios
 Pinze per usi multipli

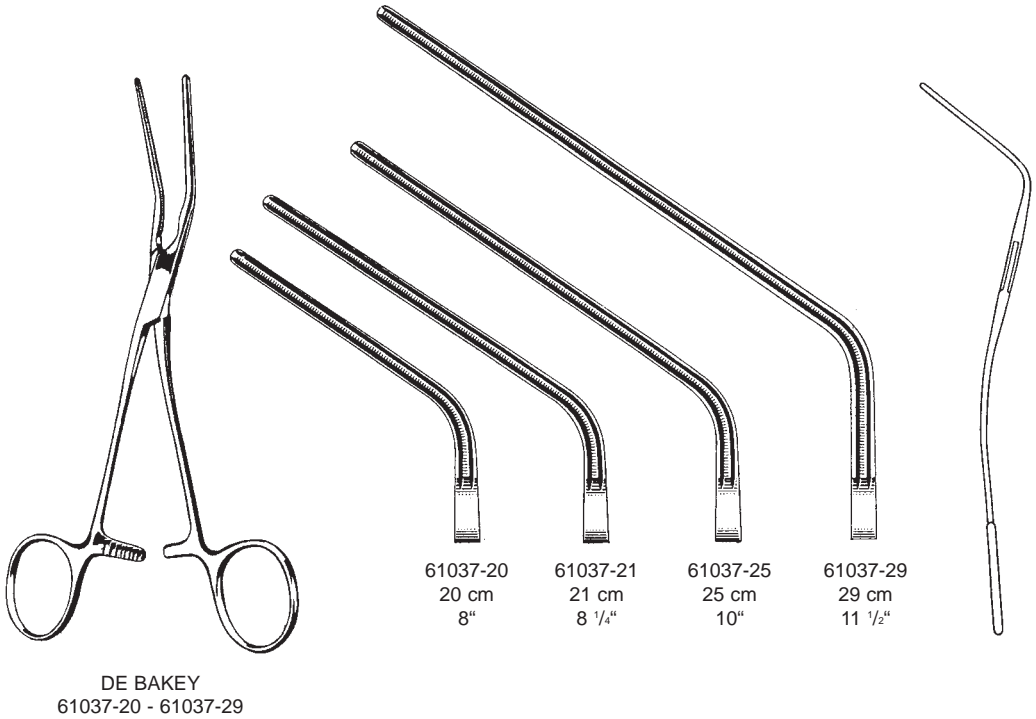
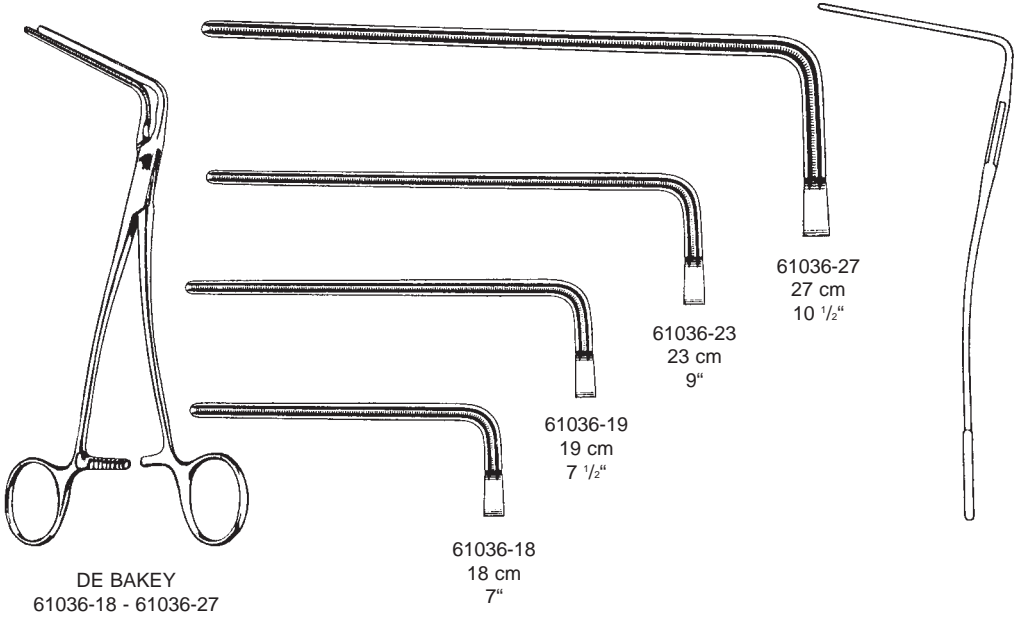

Atrauma-Arterienklemmen
Atrauma hemostatic forceps
Pinzas hemostáticas atraumáticas
Pinze emostatiche Atrauma

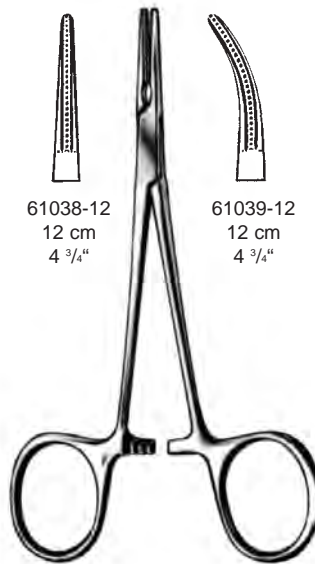

61038-12
12 cm
4 3/4"

61039-12
12 cm
4 3/4"

DE BAKEY-MOSQUITO
61038-12 - 61039-12

Aortaklemme, Katheterklemme
 Aortic clamps, Catheter clamps
 Pinzas-clamps para aorta, Pinzas para catéteres
 Pinze per aorta, Pinze per cateteri

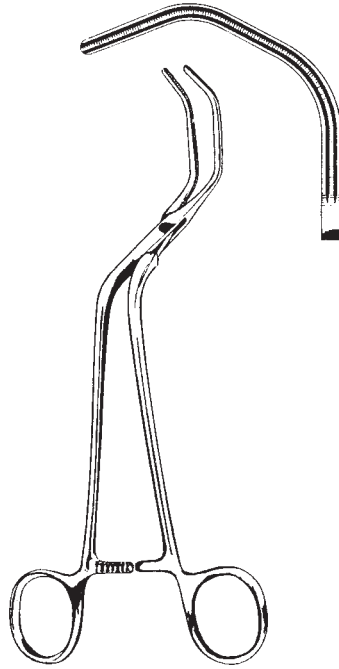

DIETRICH
 61040-21 21 cm, 8 1/4"

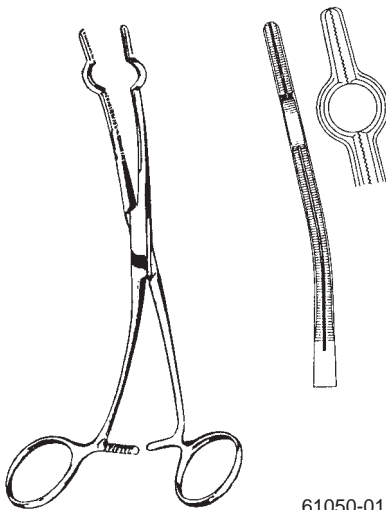

COOLEY
 61050-01 - 61050-07

Charrière (French)	Länge Length Largo Lungo cm		
24	16	6 1/4"	61050-01
26	16	6 1/4"	61050-02
28	20	8"	61050-03
30	20	8"	61050-04
32	20	8"	61050-05
36	20	8"	61050-07

61050-01 - 61050-02
 für Kinder
 for children
 para niños
 per bambini

61050-03 - 61050-07
 für Erwachsene
 for adults
 para adultos
 per adulti

Carotis-Shuntklemmen
Carotid Shunt Clamps
Pinzas para shunt carótido
Pinze per carotide



JAVID
61045-18
17,5 cm, 6.9"



JAVID
61046-19
18 cm, 7"

Atrauma Cardiovascular-Klemmen
Atrauma Cardiovascular Forceps
Pinzas-clamps cardiovasculares
Pinze per chirurgia vascolare

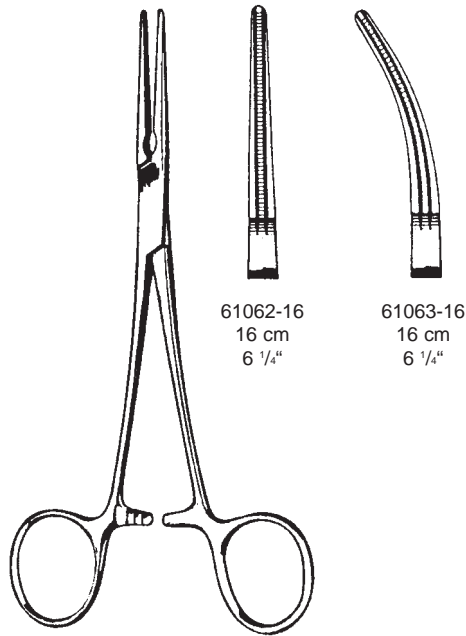

DE BAKEY-RANKIN
61062-16 - 61063-16

Atrauma Cardiovascular-Klemmen
 Atrauma Cardiovascular Forceps
 Pinzas-clamps cardiovasculares
 Pinze per chirurgia vascolare

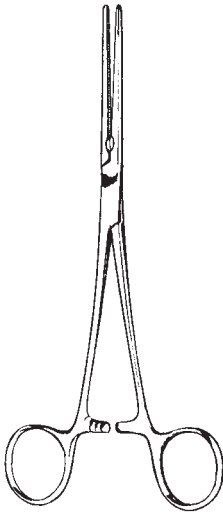

DE BAKEY-PEAN
 61138-14 - 61138-20



61138-14
 14 cm
 5 1/2"



61138-16
 16 cm
 6 1/4"



61138-18
 18 cm
 7"



61138-20
 20 cm
 8"

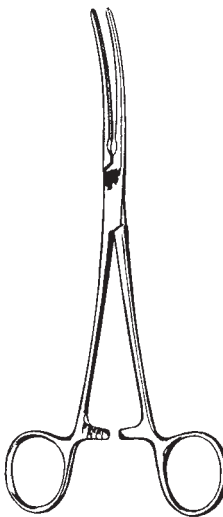

DE BAKEY-PEAN
 61139-14 - 61139-20



61139-14
 14 cm
 5 1/2"



61139-16
 16 cm
 6 1/4"



61139-18
 18 cm
 7"



61139-20
 20 cm
 8"

Atrauma Cardiovascular-Klemmen
 Atrauma Cardiovascular Forceps
 Pinzas-clamps cardiovasculares
 Pinze per chirurgia vascolare

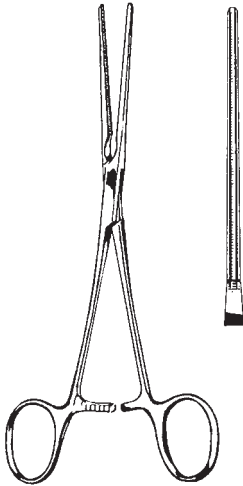

DE BAKEY
 61140-17
 17 cm, 6 ³/₄"

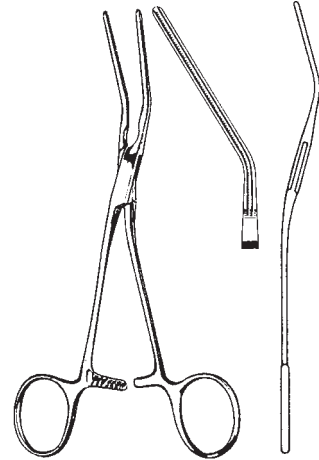

DE BAKEY
 61141-16
 16 cm, 6 ¹/₄"

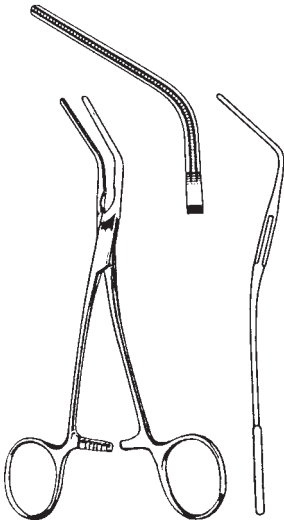

DE BAKEY
 61143-15
 15 cm, 6"

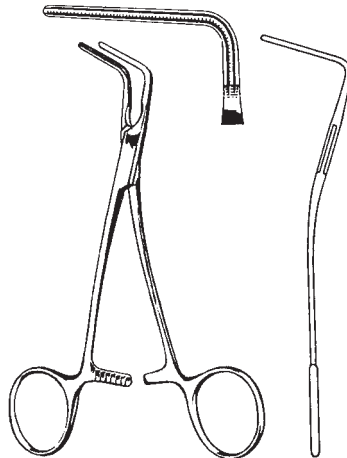

DE BAKEY
 61145-15
 15 cm, 6"

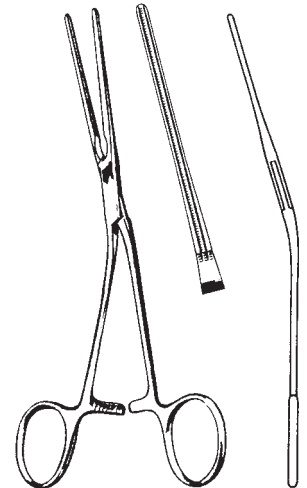

DE BAKEY
 61147-17
 17 cm, 6 ³/₄"

Atrauma Cardiovascular-Klemmen
 Atrauma Cardiovascular Forceps
 Pinzas-clamps cardiovasculares atraumáticas
 Pinze cardiovascolari atraumatiche

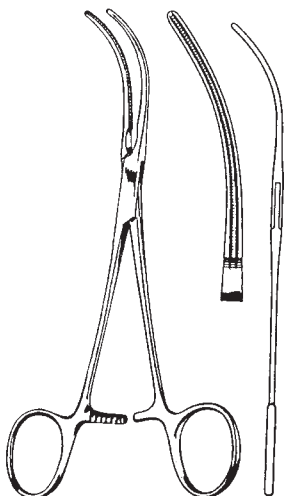

GLOVER
 61149-17
 17 cm, 6 3/4"

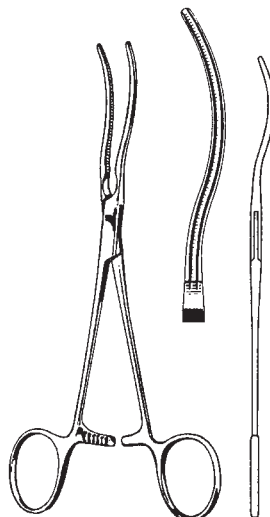

DE BAKEY
 61151-17
 17 cm, 6 3/4"

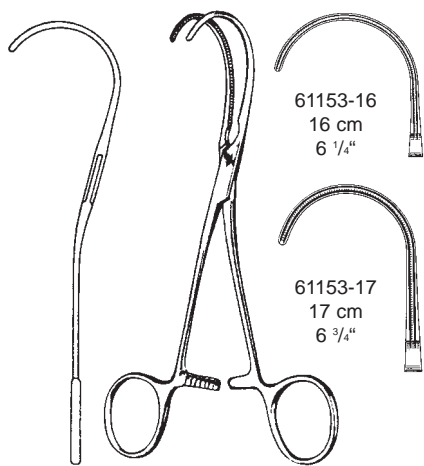

DE BAKEY
 61153-16 - 61153-17

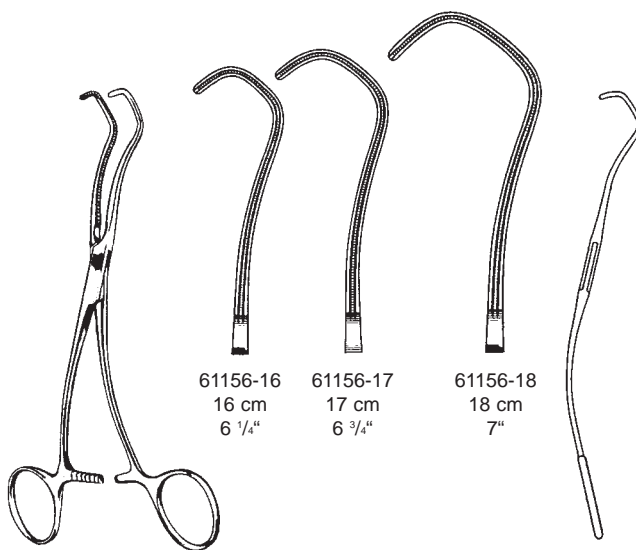

DERRA
 61156-16 - 61156-18

Atrauma Cardiovascular-Klemmen
 Atrauma Cardiovascular Forceps
 Pinzas-clamps cardiovasculares atraumáticas
 Pinze atraumatiche per chirurgia vascolare

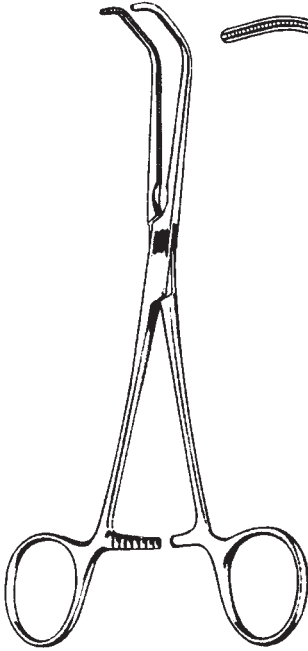

BECK
 61157-17 17 cm, 6 $\frac{3}{4}$ "

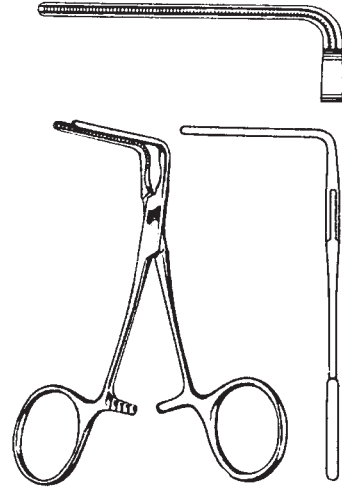

DE BAKEY
 61158-10 10 cm, 4"

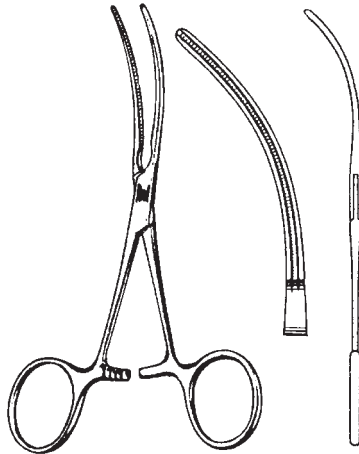

DE BAKEY
 61158-11 11 cm, 4 $\frac{3}{8}$ "

Atrauma Cardiovascular-Klemmen
Atrauma Cardiovascular Forceps
Pinzas-clamps cardiovasculares atraumáticas
Pinze atraumatiche per chirurgia vascolare

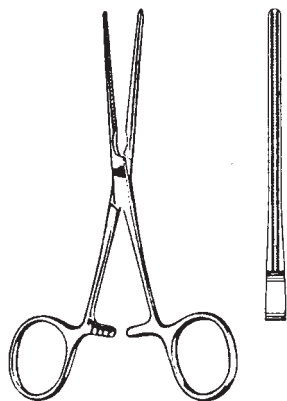

DE BAKEY
61158-12 12 cm, 4 ³/₄"

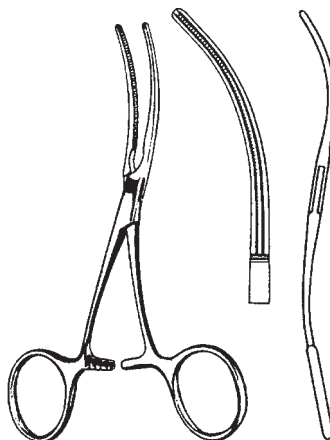

DE BAKEY
61159-12 11,5 cm, 4 ¹/₂"

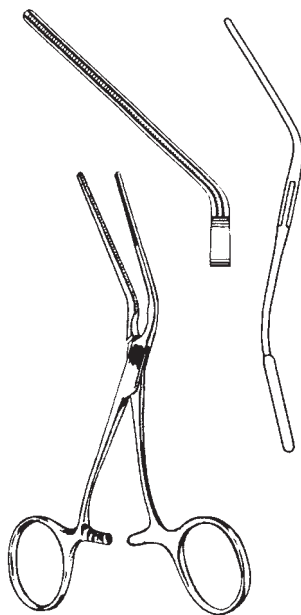

DE BAKEY
61159-13 13 cm, 5 ¹/₈"

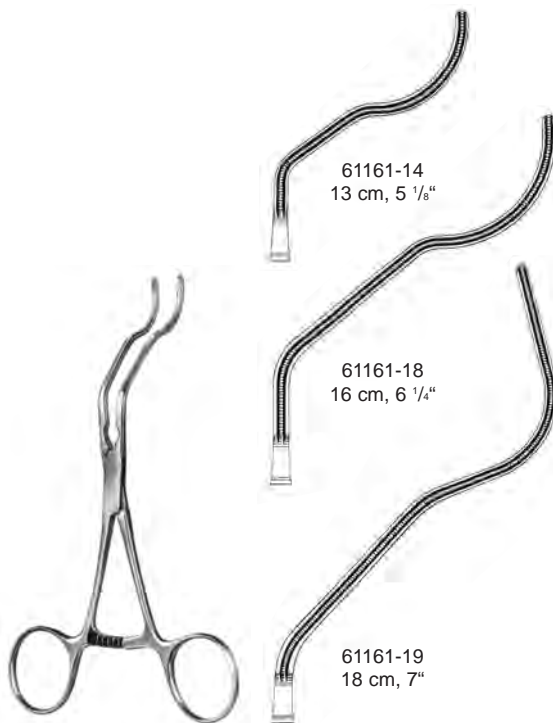

GREGORY

61161-14
13 cm, 5 ¹/₈"

61161-18
16 cm, 6 ¹/₄"

61161-19
18 cm, 7"

Atrauma Cardiovascular-Klemmen
 Atrauma Cardiovascular Forceps
 Pinzas-clamps cardiovasculares atraumáticas
 Pinze atraumatiche per chirurgia vascolare

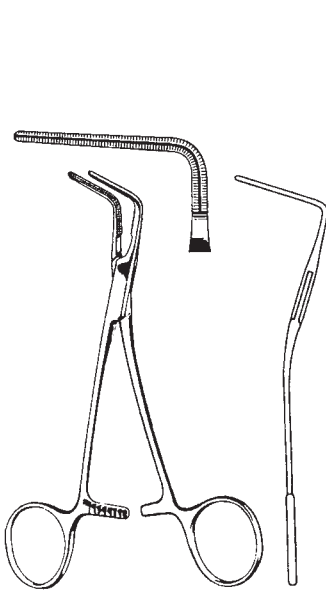

COOLEY
 61172-15
 15 cm, 6"

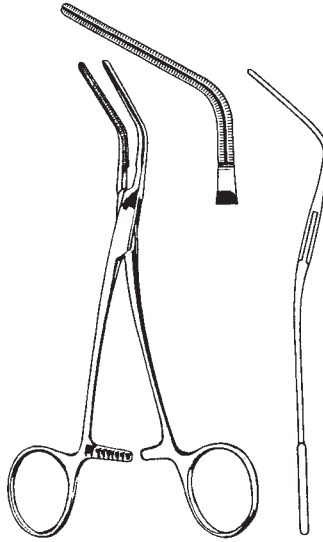

COOLEY
 61173-16
 15,5 cm, 6"

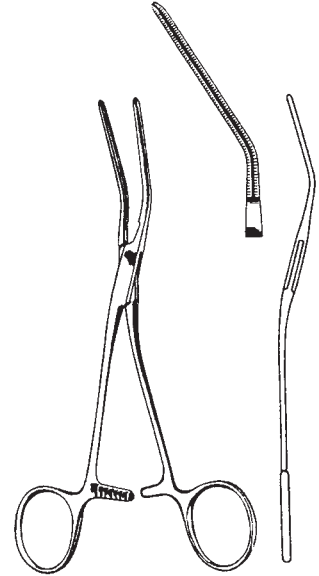

COOLEY
 61174-17
 17 cm, 6 3/4"

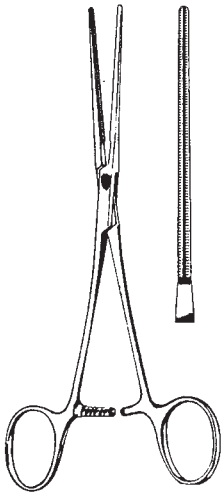

COOLEY
 61175-17
 17 cm, 6 3/4"

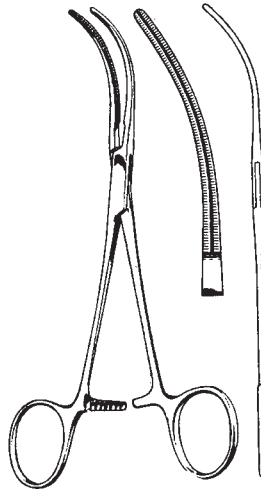

COOLEY
 61176-17
 17 cm, 6 3/4"

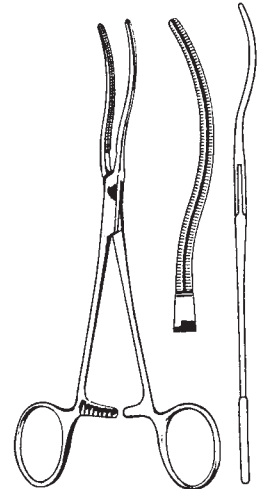

COOLEY
 61177-17
 17 cm, 6 3/4"

Atrauma Cardiovascular-Klemmen
Atrauma Cardiovascular Forceps
Pinzas-clamps cardiovasculares atraumáticas
Pinze atraumatiche per chirurgia vascolare

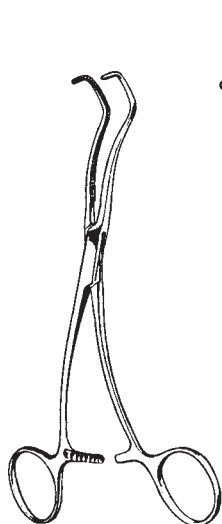

COOLEY-DERRA
61178-16 - 61179-18



61178-16
16 cm
6 1/4"

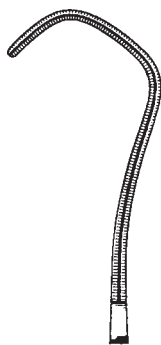

61179-18
18 cm
7"

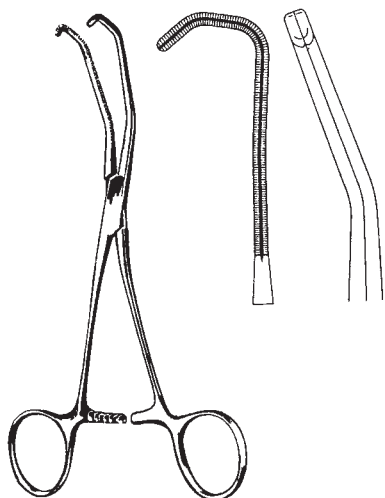

COOLEY
61180-17
17 cm, 6 3/4"

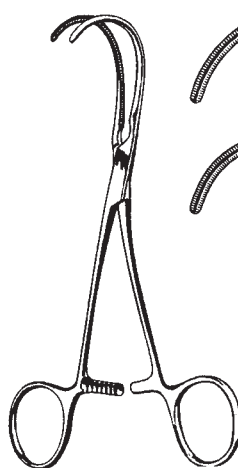

COOLEY
61187-16 - 61187-17

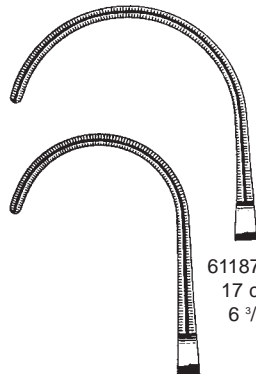

61187-17
17 cm
6 3/4"

61187-16
16 cm
6 1/4"



Anastomosenklemmen, Mehrzweck-Gefäßklemme
 Anastomosis clamp, Multi purpose Vascular Clamps
 Pinza clamp para iliac y anastomosis, Pinzas vasculares de usos multiples
 Pinze anastomosi, Pinze vascolari universali

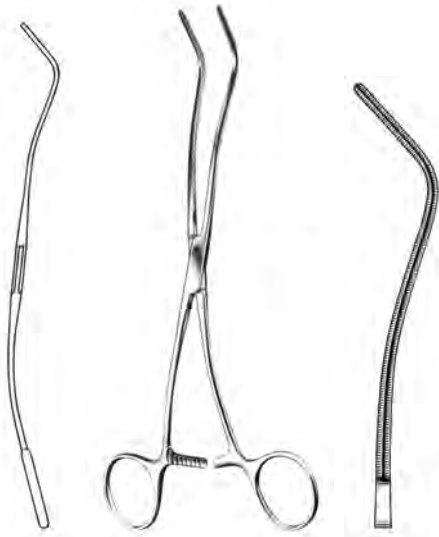

COOLEY
 61188-20 20 cm, 8"

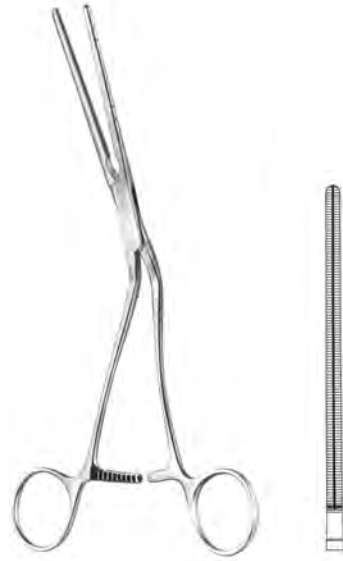

COOLEY
 61189-21 21 cm, 8 1/4"



BECK
 61190-17
 17 cm, 6 3/4"

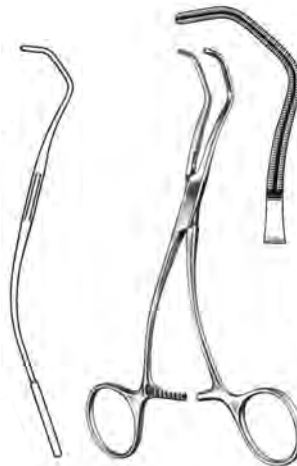

COOLEY
 61191-16
 16 cm, 6 1/4"



COOLEY
 61192-17
 17 cm, 6 3/4"

Kinder-Aortaklemme
Pediatric Aortic Clamps
Pinza aórticas pediátricas
Pinze per aorta pediatriche

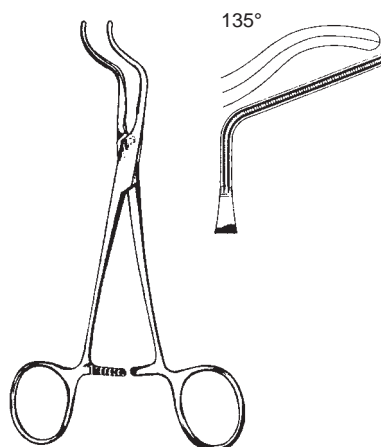

SUBRAMANIAN-MINIATURE
61259-15 15,5 cm, 6"

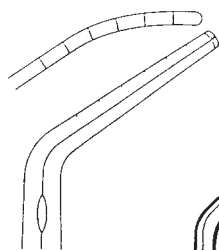

rechts
right
derecha
destra

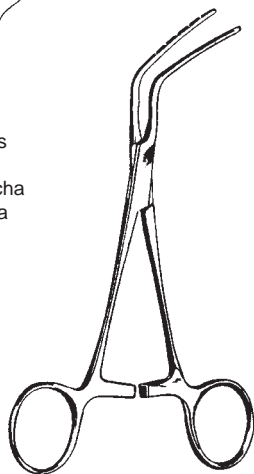

SUBRAMANIAN
61261-16 16 cm, 6 1/4"

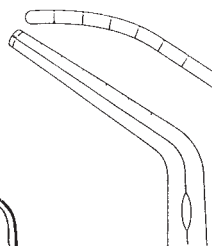

links
left
izquierda
sinistra

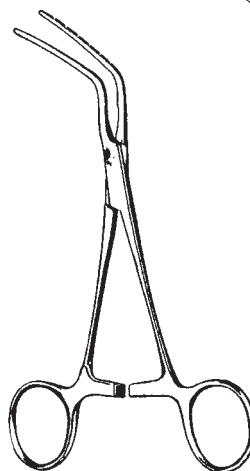

SUBRAMANIAN
61263-16 16 cm, 6 1/4"

Atrauma Neonatal- und Kinderklemmen, extra feine Modelle

Atrauma and Pediatric clamps, delicate Patterns

Pinzas-clamps para recién nacidos y pediátricos, modelos muy delicados, atraumáticos

Pinze Atrauma per neonati e bambini, modelli estremamente fini

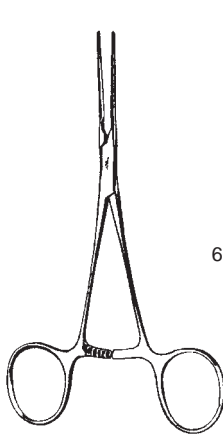

61266-01
14 cm
5 1/2"

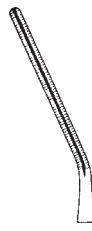

61266-02
14 cm
5 1/2"

COOLEY
61266-01 - 61266-02
14 cm, 5 1/2"

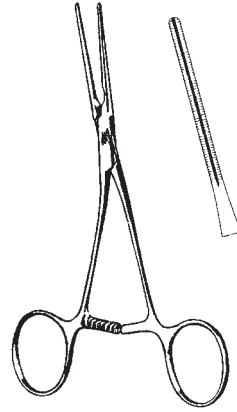

COOLEY
61266-03 14 cm, 5 1/2"

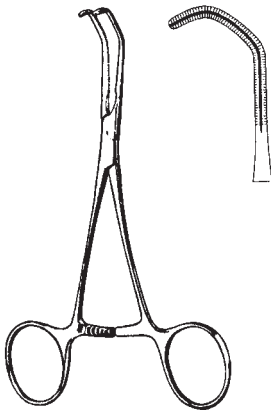

COOLEY
61266-04 14 cm, 5 1/2"

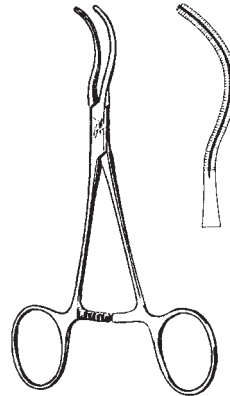

COOLEY
61266-05 14 cm, 5 1/2"

Atrauma Neonatal- und Kinderklemmen
 Neonatal and Pediatric Clamps
 Pinzas-clamps pediátricas y para recién-nacidos, atraumáticas
 Pinze per neonati e bambini

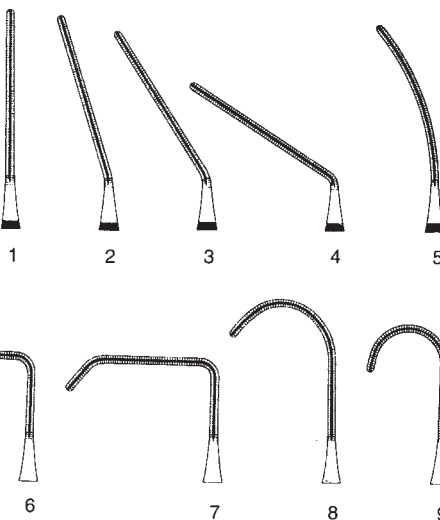
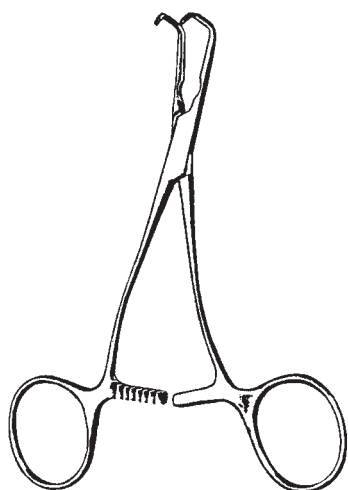



Fig.	gerade straight rectas rette	
1	61372-01 14 cm, 5 1/2"	
2	61372-02 14 cm, 5 1/2"	
3	61372-03 14 cm, 5 1/2"	
4	61372-04 13 cm, 5 1/8"	
5	61372-05 14 cm, 5 1/2"	
6	61372-06 13 cm, 5 1/8"	
7	61372-07 13 cm, 5 1/8"	
8	61372-08 14 cm, 5 1/2"	
9	61372-09 13,5 cm, 5 1/4"	

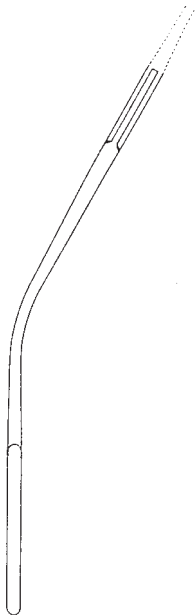

Fig.	stark abgewinkelt strongly angled ramas anguladas forte angolata	
1	61373-01 14 cm, 5 1/2"	
2	61373-02 14 cm, 5 1/2"	
3	61373-03 14 cm, 5 1/2"	
4	61373-04 13 cm, 5 1/8"	
5	61373-05 14 cm, 5 1/2"	
6	61373-06 13 cm, 5 1/8"	
7	61373-07 13 cm, 5 1/8"	
8	61373-08 14 cm, 5 1/2"	
9	61373-09 13,5 cm, 5 1/4"	

Fig.	abgewinkelt angled acodadas angolate	
1	61374-01 14 cm, 5 1/2"	
2	61374-02 14 cm, 5 1/2"	
3	61374-03 14 cm, 5 1/2"	
4	61374-04 13 cm, 5 1/8"	
5	61374-05 14 cm, 5 1/2"	
6	61374-06 13 cm, 5 1/8"	
7	61374-07 13 cm, 5 1/8"	
8	61374-08 14 cm, 5 1/2"	
9	61374-09 13,5 cm, 5 1/4"	

Clipanlegezangen für die offene Chirurgie 25° aufgebogen
 Clip Applicators for open Surgery 25° upcurved
 Pinza aplicadora de clips para cirugía abierta con ángulo de 25°
 Pinza applicatore clips per chirurgia aperto, curvo in alto 25°



15 cm, 6"

Horizon

61460-15 Small gelb / yellow / jaune/ amarillo/ giallo
 61461-15 Medium blau / blue / bleu / azul / blu

SLS Clips

61464-15 Micro weiss / white / blanc / blanco / bianco
 61465-15 Small gelb / yellow / jaune/ amarillo/ giallo
 61466-15 Small medium lila / lilac / lilas / lila / lilla
 61467-15 Medium blau / blue / bleu / azul / blu

Ethicon

61470-15 Small blau / blue / bleu / azul / blu
 61471-15 Medium weiss / white / blanc / blanco / bianco

Pilling

61481-15 Small gelb / yellow / jaune / amarillo / giallo
 61482-15 Medium blau / blue / bleu / azul / blu

Horizon

61460-19 Small gelb / yellow / jaune / amarillo / giallo
 61461-19 Medium blau / blue / bleu / azul / blu
 61462-19 Medium Large grün / green / verde / verde
 61463-19 Large orange / naranja / arancione

SLS Clips

61464-19 Micro weiss / white / blanc / blanco / bianco
 61465-19 Small gelb / yellow/ jaune / amarillo / giallo
 61466-19 Small medium lila / lilac / lilas / lila / lilla
 61467-19 Medium blau / blue / bleu / azul / blu
 61468-19 Medium Large grün / green / verde / verde
 61469-19 Large orange / naranja / arancione

Ethicon

61470-19 Small blau / blue / bleu / azul / blu
 61471-19 Medium weiss / white / blanc / blanco / bianco
 61472-19 Medium Large grün / green / verde / verde
 61473-19 Large gelb / yellow / jaune / amarillo / giallo

Pilling

61481-19 Small gelb / yellow / jaune / amarillo / giallo
 61482-19 Medium blau / blue / bleu / azul / blu
 61484-19 Medium Large grün / green / verde / verde
 61483-19 Large orange / naranja / arancione



19 cm, 7 1/2"

Clipanlegezangen für die offene Chirurgie 25° aufgebogen
Clip Appliers for open Surgery 25° upcurved
Pinza aplicadora de clips para cirugía abierta con ángulo de 25°
Pinza applicatore clips per chirurgia aperto, curvo in alto 25°

Horizon

61461-28 Medium blau / blue / bleu / azul / blu
61462-28 Medium Large grün / green / verde / verde
61463-28 Large orange / naranja / arancione

SLS Clips

61464-28 Micro weiss / white / blanco / bianco
61465-28 Small gelb / yellow / jaune / amarillo / giallo
61466-28 Small medium lila / lilac / lilas / lila / lilla
61467-28 Medium blau / blue / bleu / azul / blu
61468-28 Medium Large grün / green / verde / verde
61469-28 Large orange / naranja / arancione

Ethicon

61471-28 Medium weiss / white / blanco / bianco
61472-28 Medium Large grün / green / verde / verde
61473-28 Large gelb / yellow / jaune / amarillo / giallo

Pilling

61482-28 Medium blau / blue / bleu / azul / blu
61484-28 Medium Large grün / green / verde / verde
61483-28 Large orange / naranja / arancione



28 cm, 11"

Atrauma Cardiovascular-Klemmen, extra feine Modelle
 Atrauma Cardiovascular Forceps, extra delicate Patterns
 Pinzas-clamps cardiovasculares, modelos muy delicados, atraumáticos
 Pinze atraumatiche per chirurgia vascolare, modelli delicati

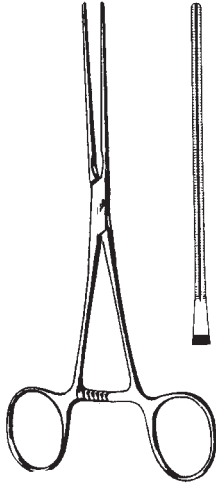

61488-16
 16,5 cm, 6 1/2"

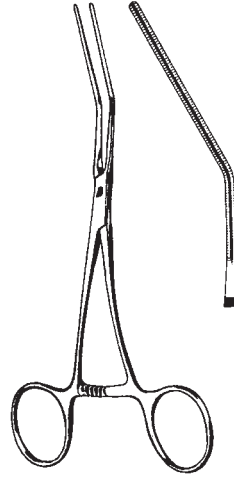

61489-16
 16 cm, 6 1/4"

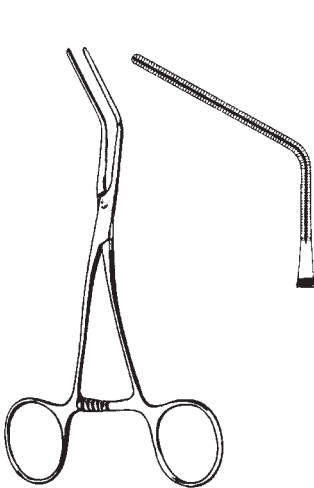

61490-15
 15 cm, 6"

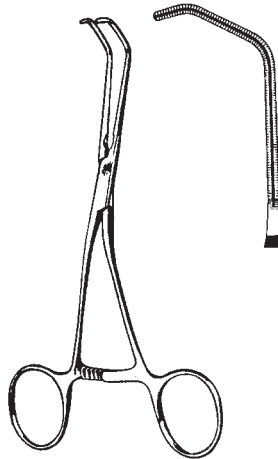

61491-15
 15 cm, 6"

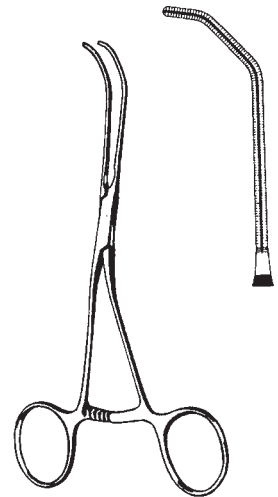

61492-16
 15,5 cm, 6"

Neonatal-Klemmen
Neonatal-Clamps
Pinzas-clamps para recién-nacidos
Pinze per neonati

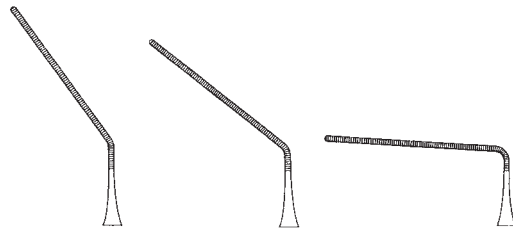

61493-01
13 cm
5 1/8"

61493-02
13 cm
5 1/8"

61493-03
11 cm
4 3/8"

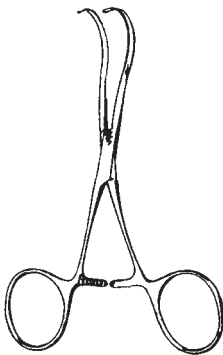

CASTANEDA
61493-01 - 61495-04

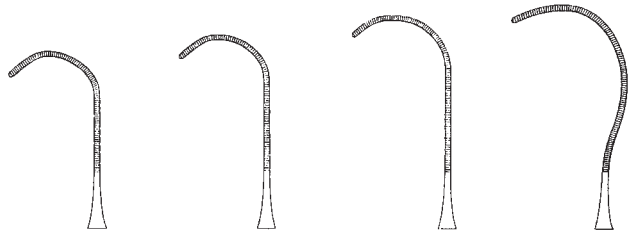

61495-01
12 cm
4 3/4"

61495-02
12 cm
4 3/4"

61495-03
12 cm
4 3/4"

61495-04
12 cm
4 3/4"

Aorta Dilatatore, Tourniquets
 Aortic Dilators, Tourniquets
 Dilatadores de aorta, Tourniquets
 Dilatatori vascolari, Tornichetti

Spreizweite von 8 - 42 mm
 Blade opening from 8 to 42 mm
 Abertura de 8 a 42 mm
 Apertura da 8 a 42 mm

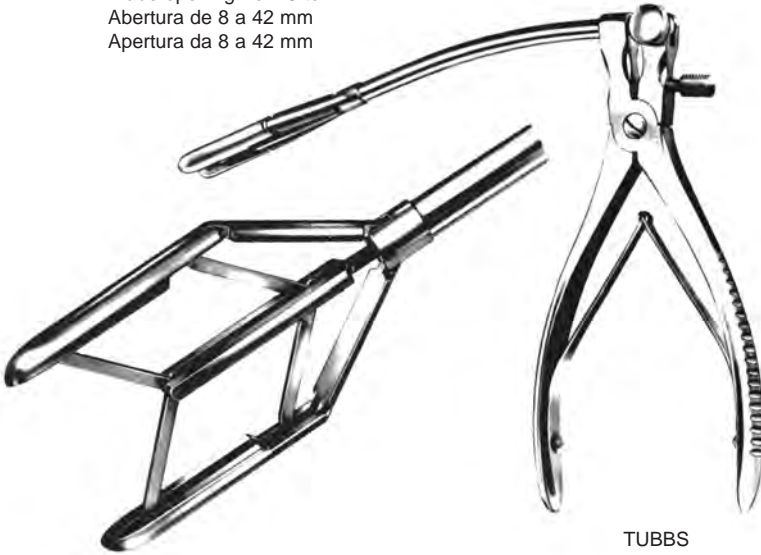

TUBBS
61500-00

Spreizweite von 8 - 15 mm
 Blade opening from 8 to 15 mm
 Abertura de 8 a 15 mm
 Apertura da 8 a 15 mm



COOLEY
61506-00



RUMEL-BELMONT
 61700-33 3,2 mm Ø
 61710-33 6,4 mm Ø
 33 cm, 13"
 flexibel, flexible,
 flexible, flessibile

61700-01
 61710-01
 Mandrin alleine
 Guide only
 Guida sola

Gefäß-Dilatatoren
 Vascular Dilators
 Dilatadores vasculares
 Dilatatori vascolari

biegsam
 malleable
 malleables
 malleabili

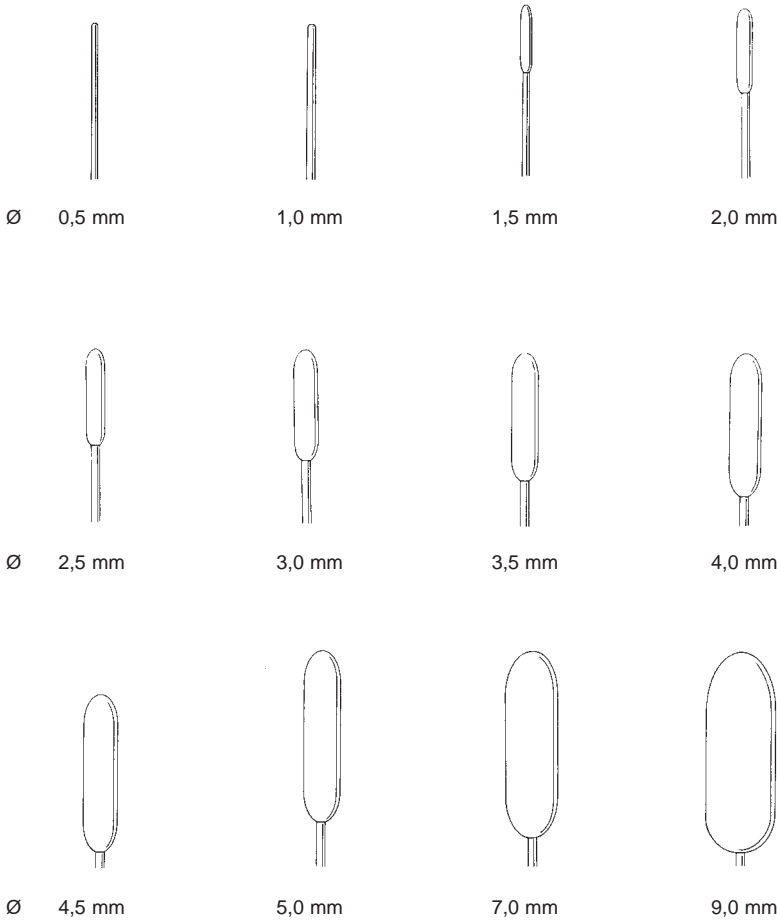

DE BAKEY

19 cm, 7 1/2"	Ø mm	35 cm, 13 3/4"
61810-05	0,5	61820-05
61810-10	1,0	61820-10
61810-15	1,5	61820-15
61810-20	2,0	61820-20
61810-25	2,5	61820-25
61810-30	3,0	61820-30
61810-35	3,5	61820-35
61810-40	4,0	61820-40
61810-45	4,5	61820-45
61810-50	5,0	61820-50
61810-70	7,0	61820-70
61810-90	9,0	61820-90

Spatel, Gefäßdissektoren
 Spatula, vascular Dissectors
 Espátulas, Disecadores vasculares
 Spatola, Dissettori vascolari

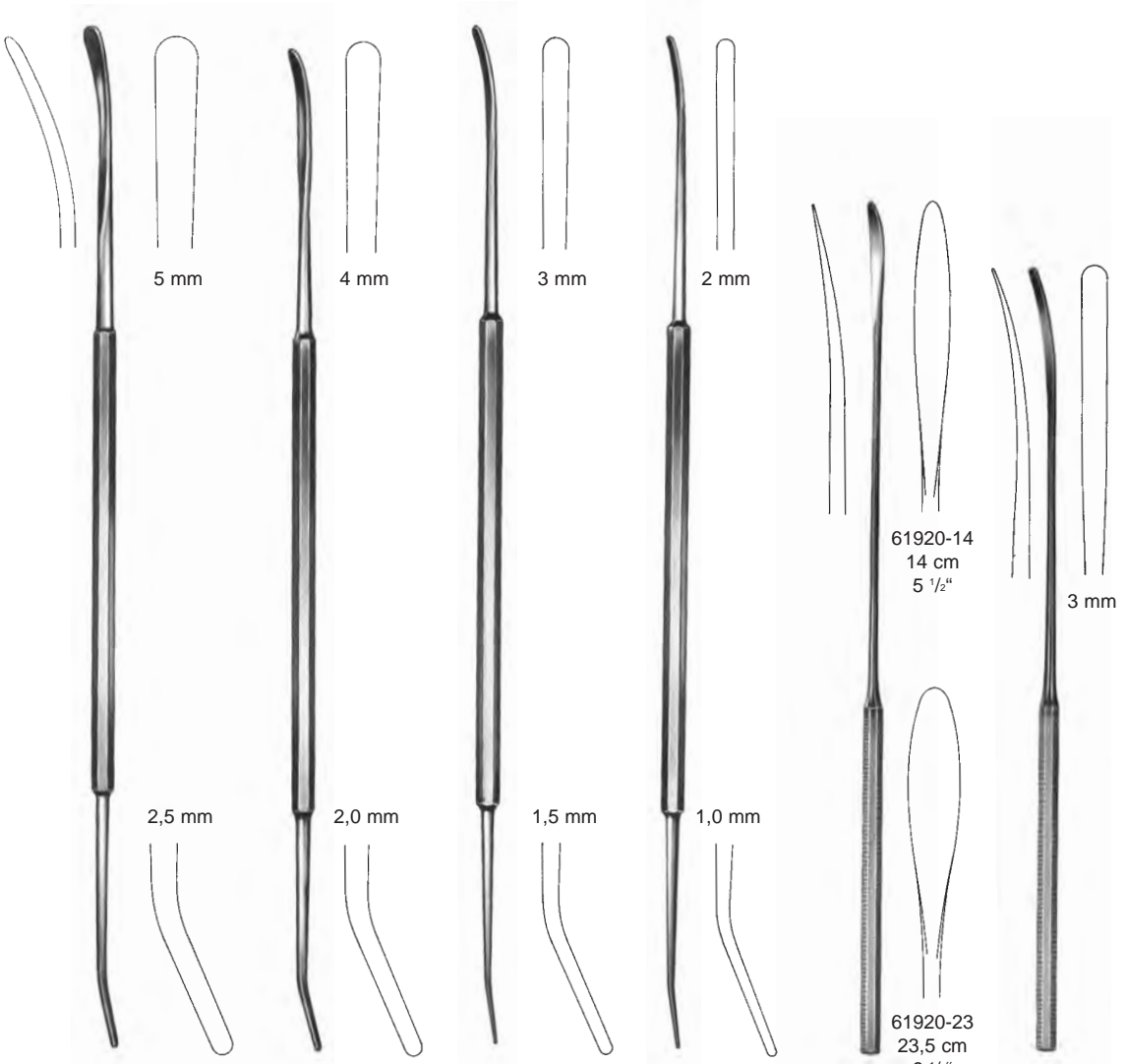

ROBB
 24 cm
 9 1/2"

Fig. 1
 61910-01

Fig. 2
 61910-02

Fig. 3
 61910-03

Fig. 4
 61910-04

stumpf
 blunt
 roma
 smussa

61930-18
 18,5 cm, 7 1/4"

61930-21
 21,5 cm, 8 1/2"

stumpf
 blunt
 roma
 smussa

Gallensteinzangen
 Gall Stone Forceps
 Pinzas para cálculos biliares
 Pinze per calcoli biliari



DESJARDINS
 23 cm, 9"



Fig. 1
 63101-23



Fig. 2
 63103-23

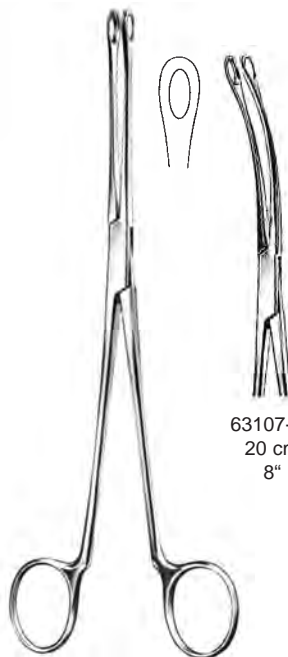

BLAKE
 63106-20 20 cm, 8"



63107-20
 20 cm
 8"



MAYO-BLAKE
 63110-20 20 cm, 8"



MAYO-BLAKE
 63111-20 20 cm, 8"



MIXTER
 63117-22 22 cm, 8 3/4"



Gallensteinsonden, Gallengangdilatoren
 Gall Stone Probes, Bile duct dilators
 Exploradores para cálculos biliares, Dilatadores para conductos biliares
 Sonde per calcoli biliari, Dilatatori per condotti biliari

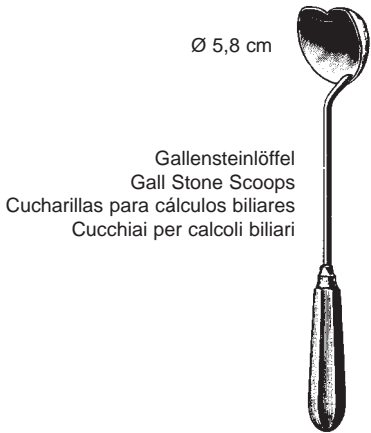

Ø 5,8 cm

Gallensteinlöffel
 Gall Stone Scoops
 Cucharillas para cálculos biliares
 Cucchiari per calcoli biliari

MOOR
 63125-28
 28 cm, 11"

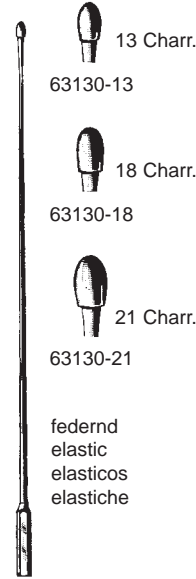

13 Charr.
 63130-13
 18 Charr.
 63130-18
 21 Charr.
 63130-21

federnd
 elastic
 elasticos
 elastiche

DESJARDINS
 63130-13 - 63130-21
 28 cm, 11"

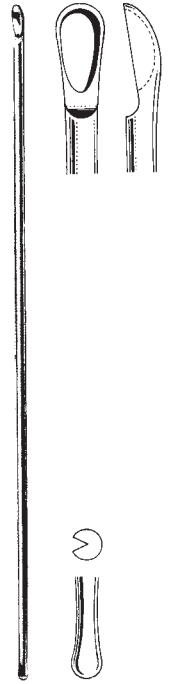

MOYNIHAN
 63142-34 34 cm, 13 1/2"

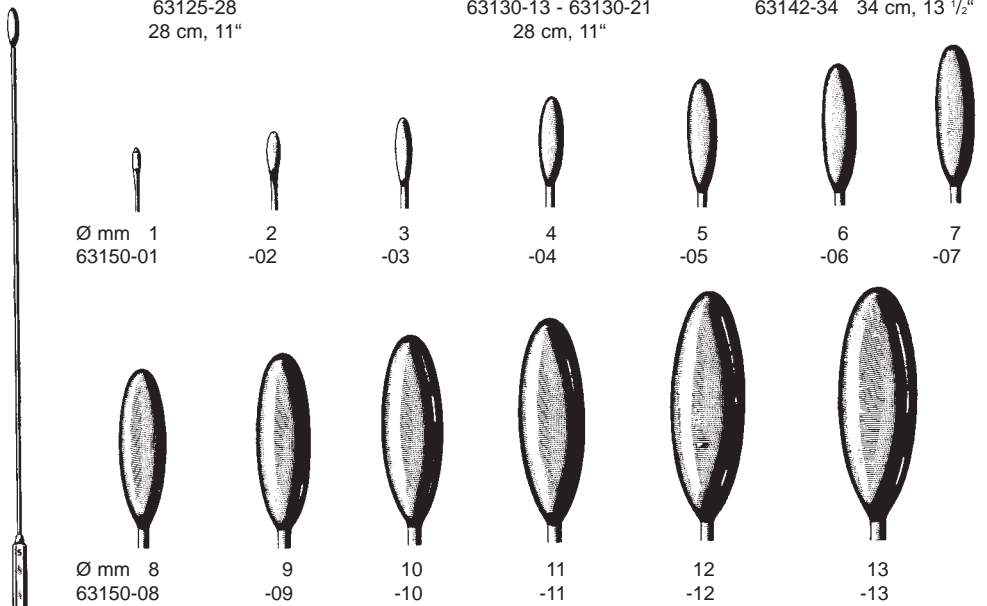

Ø mm 1 2 3 4 5 6 7
 63150-01 -02 -03 -04 -05 -06 -07

Ø mm 8 9 10 11 12 13
 63150-08 -09 -10 -11 -12 -13

biegsam
 malleable
 maleable
 malleabili

BAKES
 63150-01 - 63150-13
 30 cm, 11 3/4"

63150-00 = Satz à 9 St. / set of 9 size 3 to 11
 juego de 9 fig. 3-11 / serie di 9 pezzi

Gallensteinlöffel
 Gall Stone Scoops
 Cucharillas para cálculos biliares
 Cucchiari per calcoli biliari

biegsam
 malleable
 maleables
 malleabili

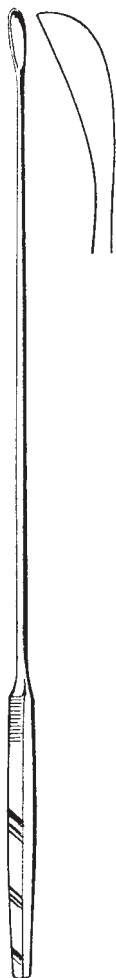

LUER-KOERTE
 63173-01 - 63173-08
 32 cm, 12 3/4"

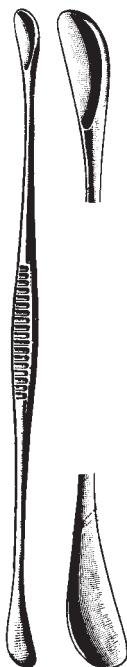

FERGUSSON
 63170-21 - 63170-23

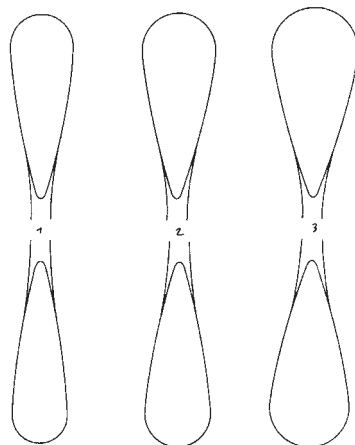

63170-21
 21,5 cm
 8 1/2"

63170-22
 22 cm
 8 3/4"

63170-23
 23,5 cm
 9 1/4"

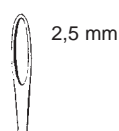

Fig. 000
 63173-01

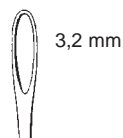

Fig. 00
 63173-02

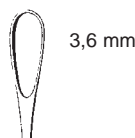

Fig. 0
 63173-03

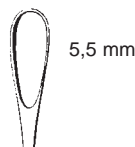

Fig. 1
 63173-04

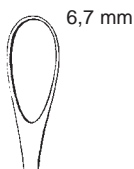

Fig. 2
 63173-05

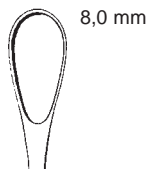

Fig. 3
 63173-06

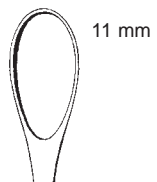

Fig. 4
 63173-07

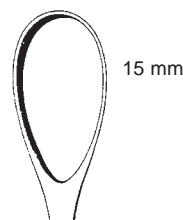

Fig. 5
 63173-08

Gallensteinlöffel
 Gall Stone Scoops
 Cucharillas para cálculos biliares
 Cucchiari per calcoli biliari



MAYO
 63175-27
 27 cm, 10 1/2"



63178-01
 Klein, small, pequeña, piccola

63178-03
 groß, large, grande

MAYO
 63178-01 - 63178-03
 27 cm, 10 1/2"



DESJARDINS
 63180-17 - 63180-27
 30 cm, 11 3/4"



17 Charr.

Fig. 1
 63180-17



21 Charr.

Fig. 2
 63180-21



24 Charr.

Fig. 3
 63180-24



27 Charr.

Fig. 4
 63180-27

federnd
 elastic
 elásticas
 elastiche



MAYO
 63210-32
 32 cm, 12 3/4"

Nierensteinzange, Nierenfistelzange
 Kidney Stone Forceps, Nephrostomy Forceps
 Pinzas para cálculos renales, Pinza para nefrostomía
 Pinze per calcoli renali, Pinze per nefrostomia



RANDALL

- Fig. 1 63231-01 23 cm, 9"
- Fig. 2 63231-02 22 cm, 8 3/4"
- Fig. 3 63231-03 22 cm, 8 3/4"
- Fig. 4 63231-04 22 cm, 8 3/4"
- Fig. 5 63231-05 19 cm, 7 1/2"
- Fig. 6 63231-06 19 cm, 7 1/2"

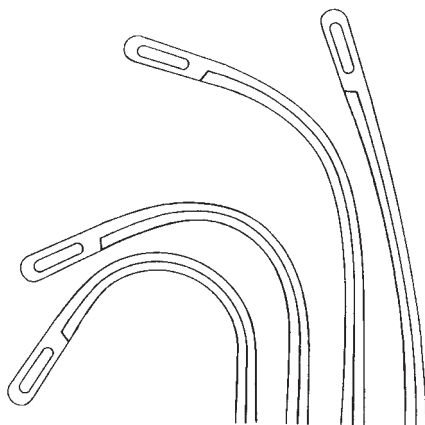

Fig. 4 Fig. 3 Fig. 2 Fig. 1

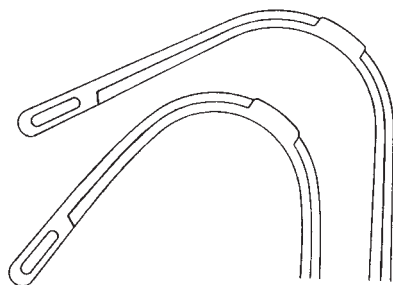

Fig. 6 Fig. 5

Nierensteinzange
Kidney Stone Forceps
Pinzas para cálculos renales
Pinze per calcoli renali



HEIMING

für Kinder
for children
para niños
per bambini



63232-01
17 cm, 6 3/4"



63232-02
16 cm, 6 1/4"

Darm-Organfaßzangen
 Bowel and Tissue Grasping Forceps
 Pinzas para coger intestinos y tejidos
 Pinze per afferrare intestini e tessuti

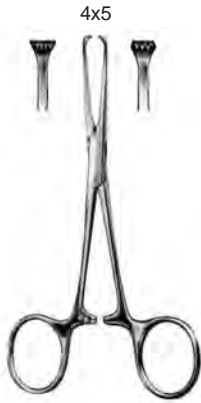

ALLIS-BABY
 65102-12 12 cm, 4 3/4"
 65102-14 14 cm, 5 1/2"

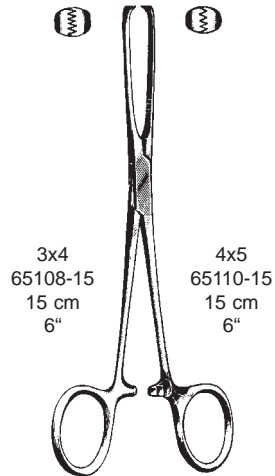

3x4 65108-15 15 cm 6"
 4x5 65110-15 15 cm 6"

ALLIS 5x6
 15 cm 6" 65120-15
 19 cm 7 1/2" 65120-19
 22 cm 8 3/4" 65120-22
 24 cm 9 1/2" 65120-24



atrauma
 atraumatic
 atraumática
 atraumatica

ALLIS
 65124-16 16 cm, 6 1/4"
 65124-20 20 cm, 8"
 65124-22 22 cm, 8 3/4"
 65124-25 25 cm, 10"
 65124-30 30 cm, 11 3/4"

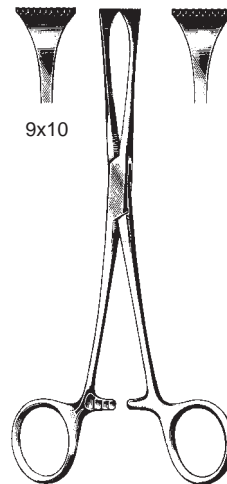

9x10

ALLIS-ADAIR
 65130-15
 15,5 cm, 6"

Darm-Organfaßzangen
 Bowel and Tissue Grasping Forceps
 Pinzas para coger intestinos y tejidos
 Pinze per afferrare intestini e tessuti

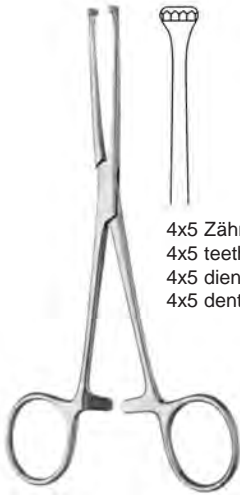

4x5 Zähne
 4x5 teeth
 4x5 dientes
 4x5 denti

LOCKWOOD-ALLIS
 65132-16 16 cm, 6 1/4"
 65132-20 20 cm, 8"

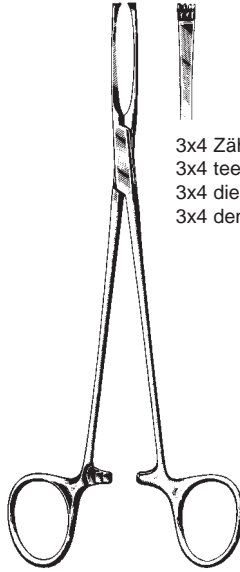

3x4 Zähne
 3x4 teeth
 3x4 dientes
 3x4 denti

JUDD-ALLIS
 65140-15 15 cm, 6"
 65140-19 19 cm, 7 1/2"



5x6 Zähne
 5x6 teeth
 5x6 dientes
 5x6 denti

BOYS-ALLIS
 65145-15 15 cm, 6"

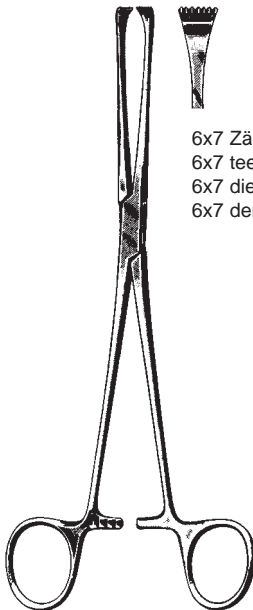

6x7 Zähne
 6x7 teeth
 6x7 dientes
 6x7 denti

THOMS-ALLIS
 65150-20 20 cm, 8"



2x3 Zähne
 2x3 teeth
 2x3 dientes
 2x3 denti

LITTLEWOOD
 65154-18 18,5 cm, 7 1/4"

Darmfaßzangen
 Intestinal Forceps
 Pinzas para coger tejidos e intestinos
 Pinze per afferrare tessuti ed organi

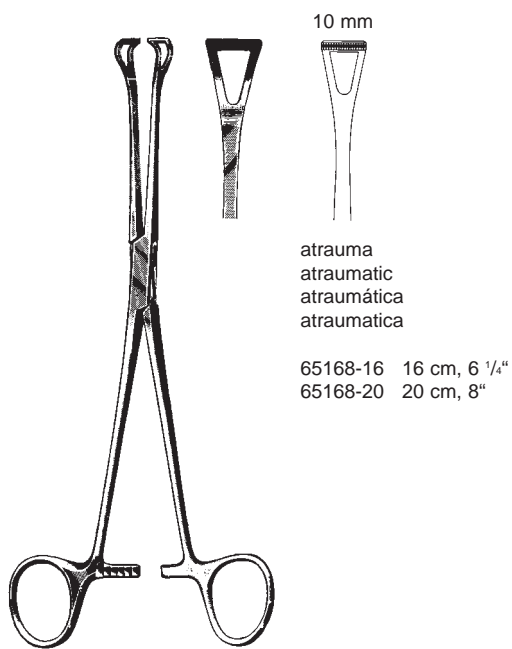

10 mm

atrauma
 atraumatic
 atraumática
 atraumatica

65168-16 16 cm, 6 1/4"
 65168-20 20 cm, 8"

BABCOCK

- 65160-14 14 cm, 5 1/2"
- 65160-16 16 cm, 6 1/4" **65164-16 TC 16 cm**
- 65160-18 18 cm, 7"
- 65160-20 20 cm, 8" **65164-20 TC 20 cm**
- 65160-24 24 cm, 9 1/2"

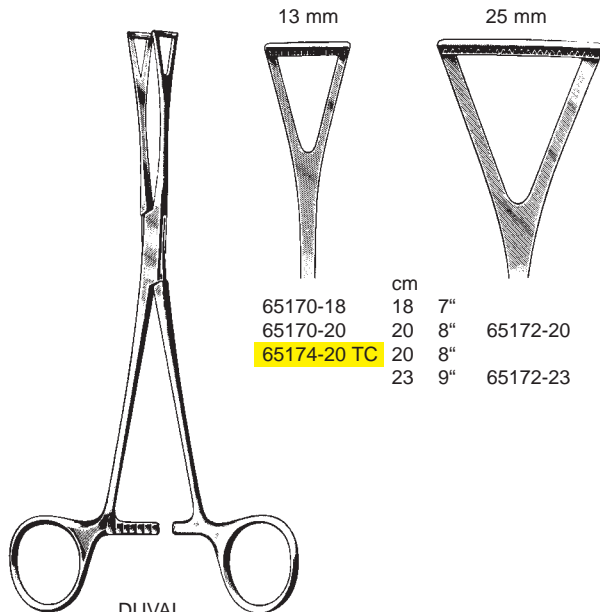

13 mm

25 mm

	cm	
65170-18	18	7"
65170-20	20	8"
65174-20 TC	20	8"
	23	9"
		65172-20
		65172-23

DUVAL

65170-18 - 65172-23

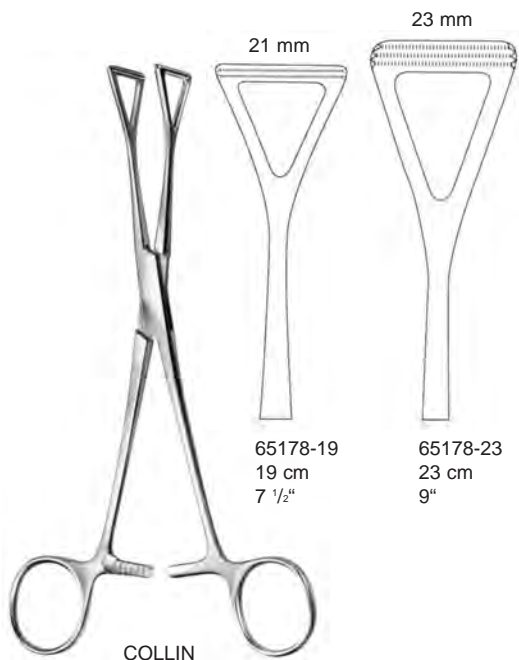

21 mm

23 mm

65178-19
 19 cm
 7 1/2"

65178-23
 23 cm
 9"

COLLIN



WILLIAMS

65180-16 16,5 cm, 6 1/2"

Darmklemmen
 Intestinal Forceps
 Pinzas intestinales
 Pinze intestinali

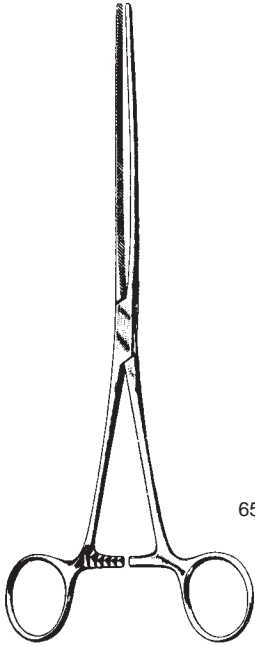

DOYEN-BABY
 65210-18 65211-18
 18 cm, 7"

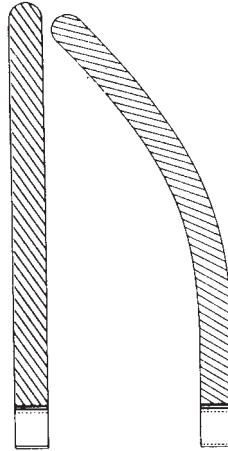
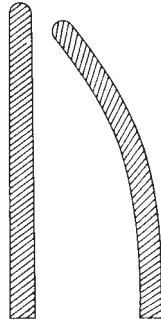

DOYEN
 65210-21 21 cm, 8 1/4" 65211-21
 65210-23 23 cm, 9" 65211-23

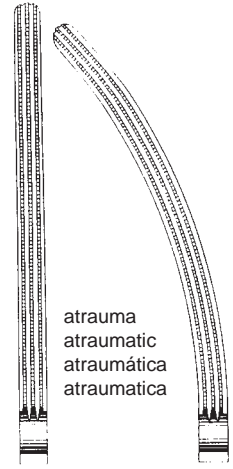

atrauma
 atraumatic
 atraumática
 atraumatica

DOYEN
 65216-13 13 cm, 5 1/8" 65217-13
 65216-16 16 cm, 6 1/4" 65217-16
 65216-18 18 cm, 7" 65217-18
 65216-21 21 cm, 8 1/4" 65217-21
 65216-23 23 cm, 9" 65217-23

DOYEN
 65210-18 - 65217-23

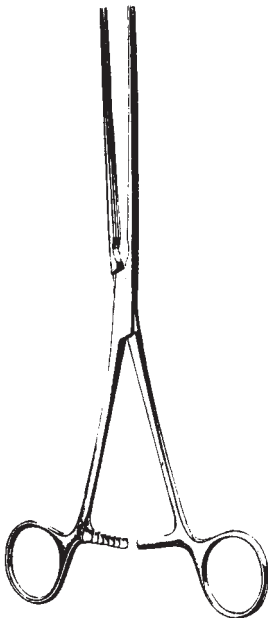

KOCHER
 65220-22 - 65227-28

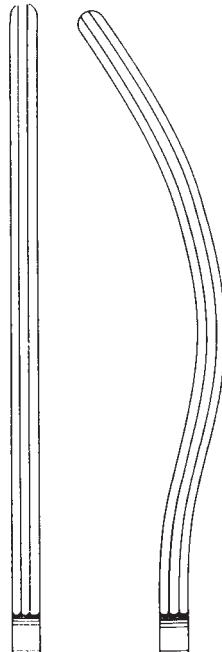

65220-13 13 cm, 5 1/8" 65221-13 BABY-KOCHER
 65220-22 22 cm, 8 3/4" 65221-22
 65220-25 25 cm, 10" 65221-25
 65220-28 28 cm, 11" 65221-28

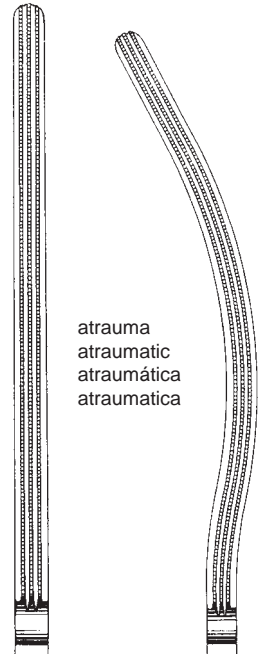

atrauma
 atraumatic
 atraumática
 atraumatica

65226-22 22 cm, 8 3/4" 65227-22
 65226-25 25 cm, 10" 65227-25
 65226-28 28 cm, 11" 65227-28

Darmklemmen
 Intestinal Forceps
 Pinzas intestinales
 Pinze intestinali

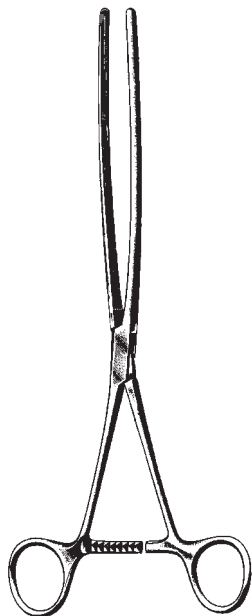

MAYO-ROBSON
 65230-21 - 65237-25
 21 - 25 cm
 8 1/4" - 10"

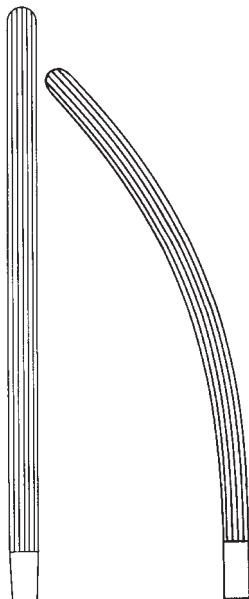

65230-21
 65230-23
 65230-25

65231-21
 65231-23
 65231-25

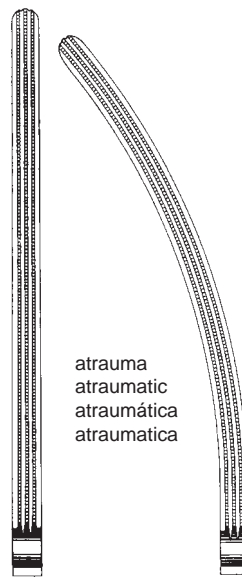

atrauma
 atraumatic
 atraumática
 atraumatica

65236-25

65237-25



SCUDDER
 65238-33
 33 cm
 13"

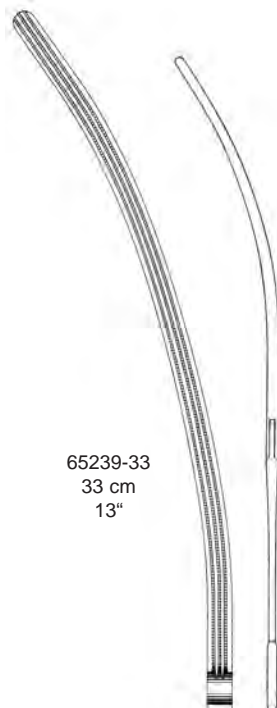

65239-33
 33 cm
 13"

Darmklemmen
Intestinal Forceps
Pinzas intestinales
Pinze intestinali



FEHLAND
65241-23
23,5 cm 9 1/4"



RESANO
65242-30
30 cm, 11 3/4"

Magen-Darmklemmen
Intestinal and Stomach Clamps
Pinzas-clamps intestinales y estomacales
Pinze intestinali e stomacali

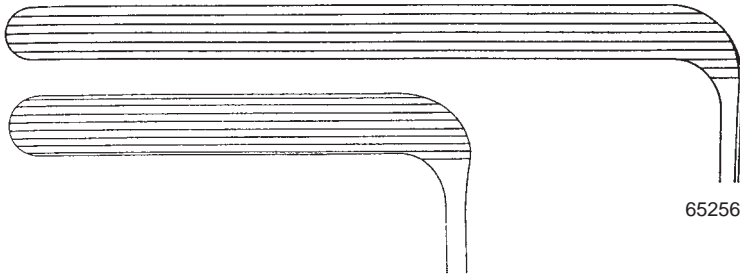

65255-19

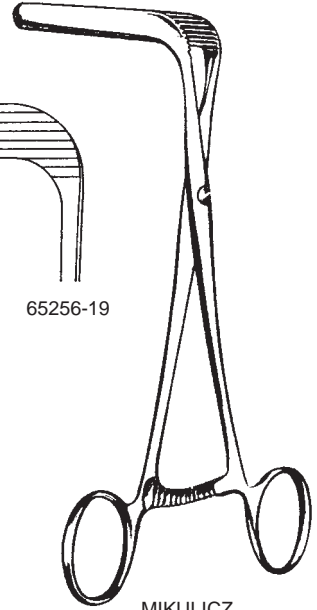

65256-19

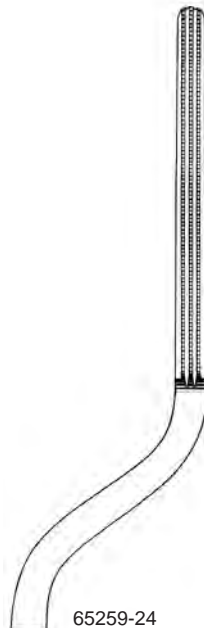
MIKULICZ
19 cm, 7 1/2"BRUNNER
24 cm, 9 1/2"

65259-24

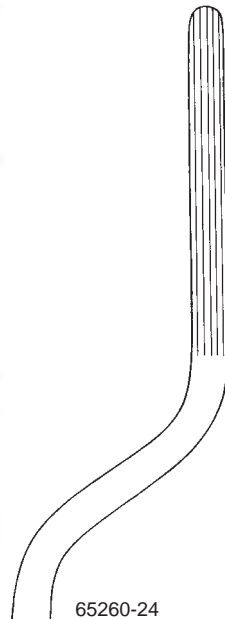

65260-24

Pylorusspreizer, Blinddarmklemmen
Pylorus spreader, Blindgut forceps
Separador para píloro, Pinzas para apéndice
Divaricatori per piloro, Pinza per appendice



BENSON
65261-15
15,5 cm, 6"

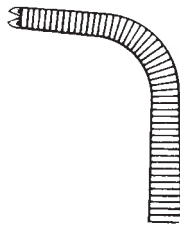

KLEINSCHMIDT
65262-12
12 cm, 4 3/4"

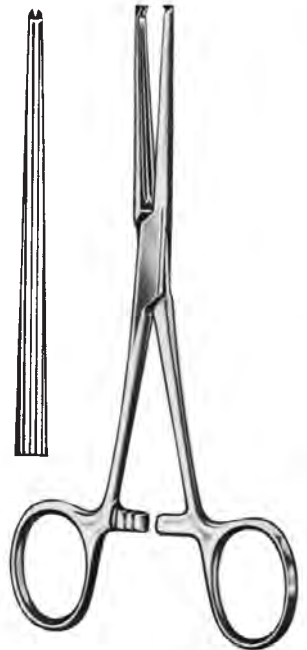

ALLEN
65263-15 15 cm, 6"
65263-20 20 cm, 8"

Atrauma Rektum-Anastomosenklemmen, Anastomosenklemmen
 Atrauma Sigmoid Anastomosis Forceps, Anastomosis Clamp Forceps
 Pinzas para anastomosis del recto atraumáticas, Pinzas clamps para anastomosis
 Pinze atrauma per anastomosi del retto, Pinze per anastomosi



HAYES
 65265-26 26 cm, 10 1/4"
 65265-28 28 cm, 11"



65265-26
 26 cm, 10 1/4"

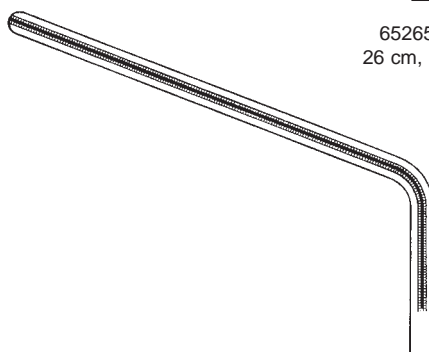

65265-28
 28 cm, 11"

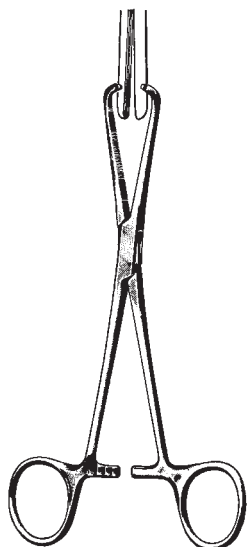

STONE
 65270-15
 15,5 cm, 6"



STONE-WATT
 65272-07 7,5 cm, 3"
 65272-10 10,0 cm, 4"



STONE-WATT
 65274-00

Anastomosenklemmen, Klemmschließzange, Klemmenhalter
 Anastomosis Clamp Forceps, Clamp closing forceps, Clamp Holder
 Pinzas-clamps para anastomosis, Pinzas para cerrar clamps, Porta-clamps
 Pinze per anastomosi, Serrapinze, Portapinze



DE MARTEL-WOLFSON

65280-05	5 cm, 2"	set of 3
65280-07	7 cm, 2 3/4"	set of 3
65280-10	10 cm, 4"	set of 3



50 mm



70 mm



100 mm



DE MARTEL-WOLFSON
 65282-26 26 cm, 10 1/4"



DE MARTEL-WOLFSON
 65284-08 8,5 cm, 3 1/2"



DE MARTEL-WOLFSON
 65284-23 23 cm, 9"

Magenquetschklemme
Stomach Clamps
Pinzas-clamps estomacales
Pinze stomacali

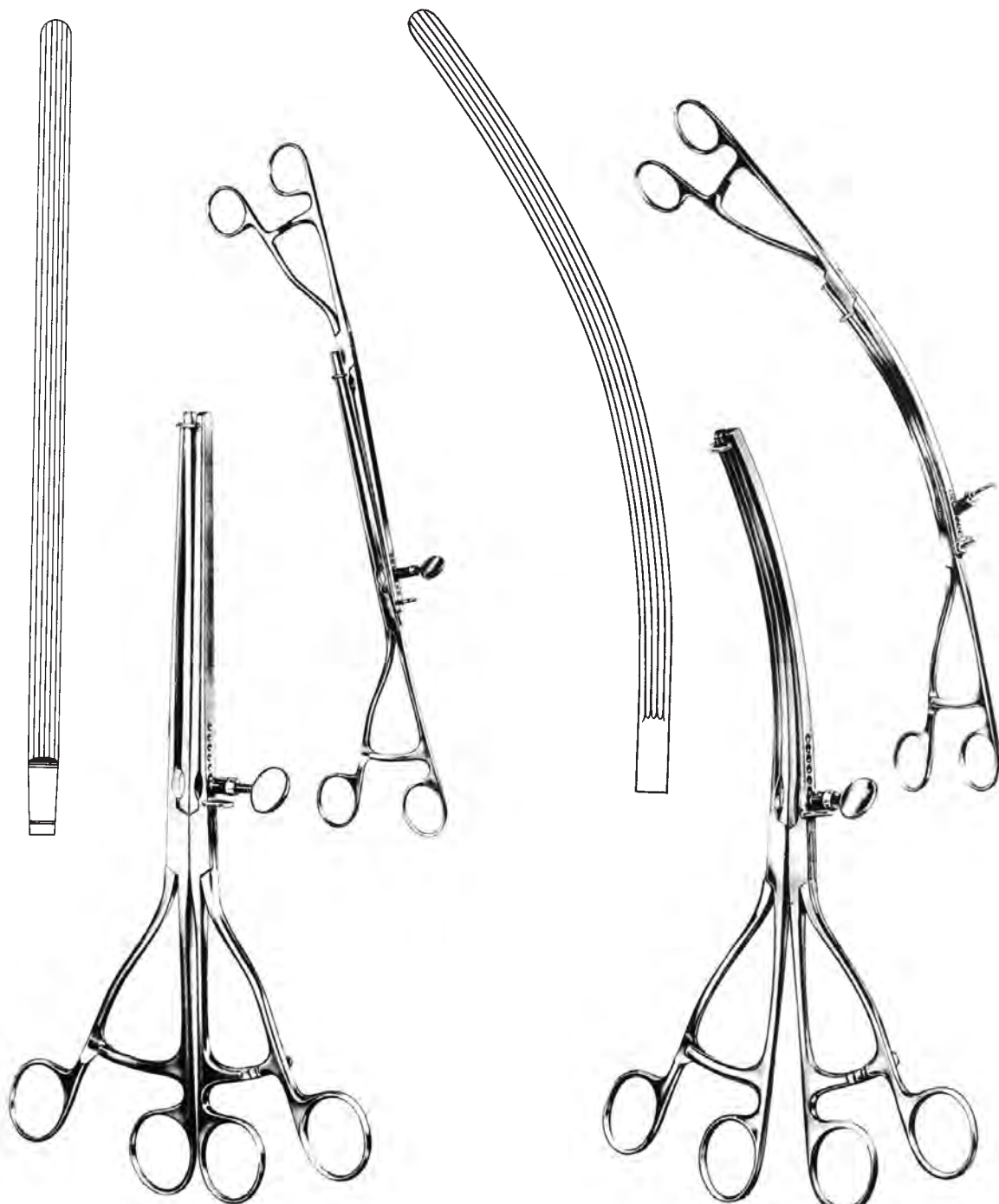

LANE
65290-30 30 cm, 11 3/4"

LANE
65291-30 30 cm, 11 3/4"

Darm- und Magenquetschklemmen
 Intestinal and Stomach clamps
 Pinzas-clamps intestinales y estomacales
 Pinze e Schiacciatori per l'intestino e lo stomaco

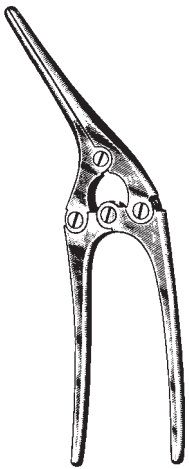

PAYR-BABY
 65310-15
 15 cm, 6"



65310-21
 21 cm, 8 1/4"

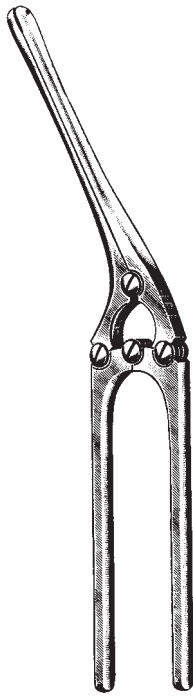

PAYR



65310-29
 29 cm, 11 1/2"



65310-35
 35 cm, 14"



Magen- und Darmnähhapparat
 Stomach and Intestinal Suturing Apparatus
 Aparato para suturar estómago e intestinos
 Apparecchiature di sutura gastro-intestinale

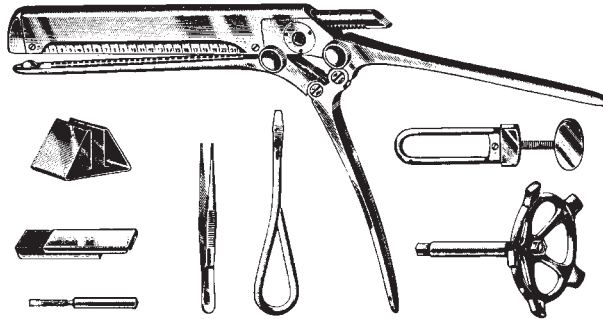

V. PETZ
 65320-00
 komplett in Holzetui
 compl. in wooden case
 en estuche de madera
 in astuccio di legno

bestehend aus:

- Nähapparat
- Holzetui
- Zusatzschloß
- Kurbel
- Füllständer
- Füllstift
- Füllpinzette
- Schraubenzieher
- Etui für Klammern
- Silberklammern
(Pack à 300 Stck.)

consisting of:

- suturing apparatus
- wooden case
- additional closing clamp
- gear wheel
- filling rack
- filling pin
- filling tweezer
- screw driver
- metal box for clips
- silver suturing clips
(Pack of 300 ea.)

compuesto de:

- Aparator para suturar
- Estuche de madera
- Cierre adicional
- Manivela
- Soporte para rellenar
- Espiga para rellenar
- Pinza para rellenar
- Destornillador
- Estuche para agrafas
- Agrafas para sutura de plata
(Paquete de 300 pzas.)

composta da:

- apparecchio per la sutura
- astuccio in legno
- Serratura supplementare
- manovella
- supporto di riempimento agraiffe
- perno per posizionare le agraiffe
- pinza per caricare
- cacciavite
- scatola in metallo per agraiffe
- agraiffe in argento
(confezione da 300 pezz.)

Prostatahaken, Kapsel­faß­zange, Prostatafaßzangen
 Prostatic Retractors, Grasping Forceps for the capsule - Anterior Lobe - and Ligature Carrier
 Separadores, Pinza para la próstata, para la cápsula, para lobo anterior, Porta-ligaduras
 Divaricatori, Pinza per afferrare la prostata - per la capsula, per lobo anteriore

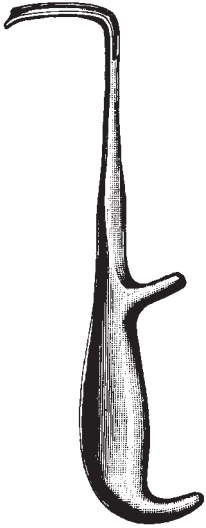

YOUNG
 67101-21
 21 cm, 8 1/4"

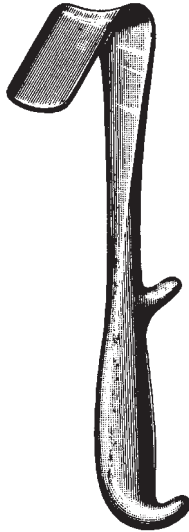

YOUNG
 67103-22
 22 cm, 8 3/4"

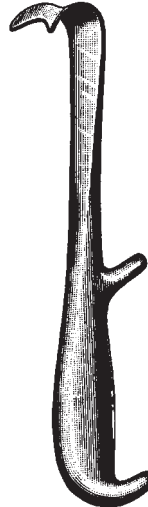

YOUNG
 67105-21
 21 cm, 8 1/4"



YOUNG
 67105-22
 22 cm, 8 3/4"

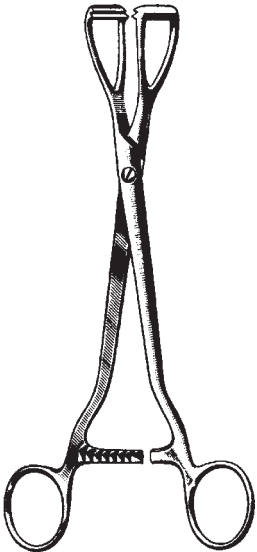

YOUNG
 67106-20
 20 cm, 8"

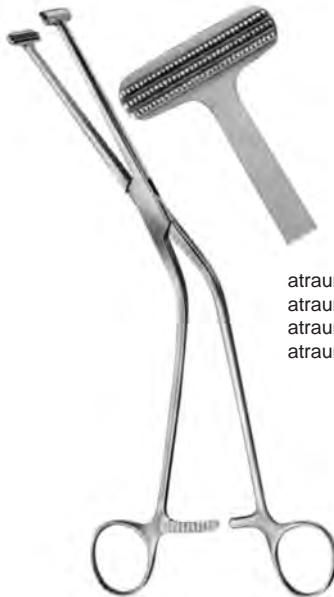

MILLIN
 67110-23
 23,5 cm, 9 1/4"

atrauma
 atraumatic
 atraumática
 atraumatica

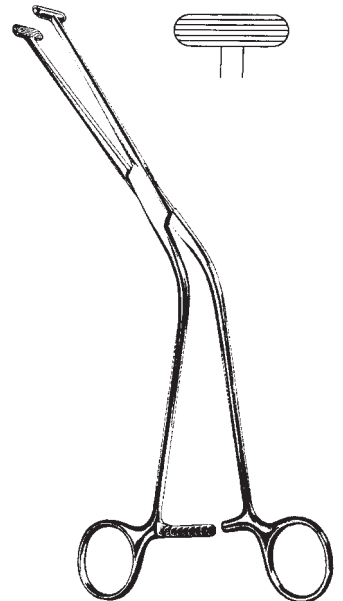

MILLIN
 67111-23
 23 cm, 9"

Kapsel­faß­zange, Prostata­faß­zangen
 Grasping Forceps for the capsule - Anterior Lobe - and Ligature Carrier
 Pinza para la próstata, para la cápsula, para lobo anterior, Porta-ligaduras
 Pinza per afferrare la prostata - per la capsula, per lobo anteriore, Portafilo

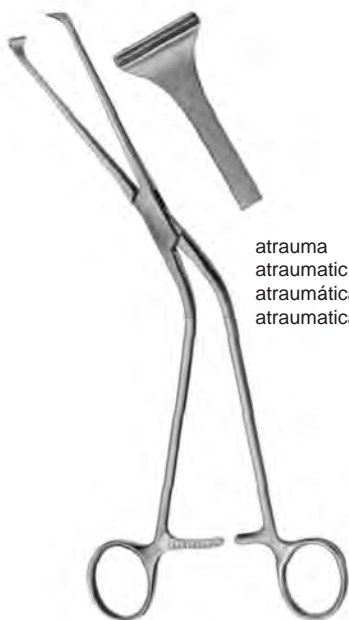

atrauma
 atraumatic
 atraumática
 atraumatica

MILLIN
 67122-23
 24,5 cm, 9 3/4"

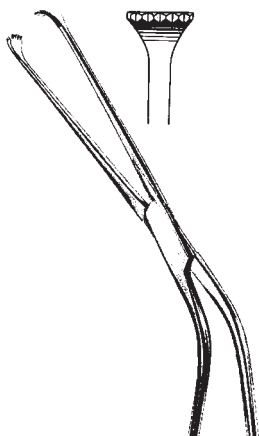

MILLIN
 67123-23
 23 cm, 9"

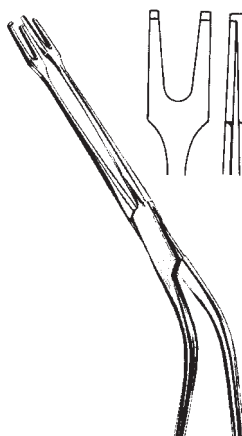

MILLIN
 67125-24
 24 cm, 9 1/2"

Prostatahaken, Blasenwundspreizer, Blasenspatel
 Prostatic Retractors, Bladder Retractors
 Separadores vesicales
 Divaricatori vescicali, Spatoli vescicali

67130-01	2 Valven, 2 blades, 2 valvas, 2 valve	57 mm x 25 mm
67130-02	2 Valven, 2 blades, 2 valvas, 2 valve	80 mm x 25 mm
67130-03	1 Valven, 1 blade, 1 valva, 1 valve	120 mm x 45 mm



- 67130-00 ohne Kaltlicht
- 67132-00 Kaltlichtaufsatz für 67130-00
- 67130-00 without fiber optic
- 67132-00 fiber optic light carrier for 67130-00
- 67130-00 sin soporte de luz fría
- 67132-00 soporte de luz fría para 67130-00
- 67130-00 senza fibre ottiche
- 67132-00 supporto per luce fredda per 67130-00



- 67150-00 mit Mittelvalve, with Central Blade
con valva central, con valva centrale
- 67155-00 ohne Mittelvalve, without Central Blade
sin valva central, senza valva centr.



Blasenwundspreizer, Blasenhalssperrer, Urethrotome
 Bladder Retractors, Bladder Neck Spreader, Urethrotomes
 Separadores vesicales, Uretrótomos
 Divaricatori vescicali, Divaricatore del collo vescicale, Uretrotomi



LEGUEU
 67163-00



MILLIN
 67165-00

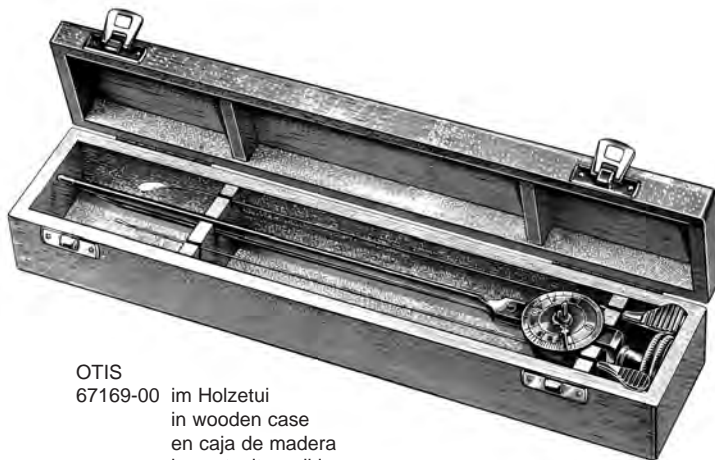

OTIS
 67169-00 im Holzetui
 in wooden case
 en caja de madera
 in contenitore di legno

67169-01 Ersatzblatt alleine
 Blade only
 Hoja de repuesto
 Lame di ricambio

Fremdkörperzange, Penisklemmen
 Foreign Body Forceps, Penis Seizing Forceps
 Pinzas para cuerpos extraños, Compresores uretrales
 Pinze per corpi estranei, Serrapene

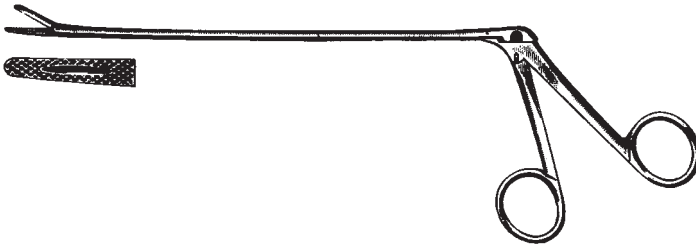

MATHIEU
 67172-20 20 cm, 8"
 67172-28 28 cm, 11"



STOCKMANN
 67175-08
 8 cm, 3 1/8"



STRAUSS
 67177-11
 11 cm, 4 3/8"

Vasektomie-Klemme
Vasectomy Forceps
Pinza para vasectomia
Pinza per vasectomia



67178-12
12 cm, 4 3/4"



67178-14
14 cm, 5 1/2"



67179-14
14,5 cm, 5 3/4"

Kathetereinführungsinstrumente, Dilatationsbougies
 Catheter Introducer, Dilating Bougies
 Introducator de catéteres, Bujías dilatadoras
 Mandrini per sonde uretrali, Candelette dilatatrici



GUYON
 67184-39
 39 cm, 15 1/2"

67185-35
 35 cm, 13 3/4"

Charr.	28 cm (11") VAN BUREN	25 cm (10") GUYON	28 cm (11") DITTEL	30 cm (11 3/4") DITTEL
8	67201-08	67205-08	67206-08	67207-08
9			67206-09	67207-09
10	67201-10	67205-10	67206-10	67207-10
11			67206-11	67207-11
12	67201-12	67205-12	67206-12	67207-12
13			67206-13	67207-13
14	67201-14	67205-14	67206-14	67207-14
15			67206-15	67207-15
16	67201-16	67205-16	67206-16	67207-16
17			67206-17	67207-17
18	67201-18	67205-18	67206-18	67207-18
19			67206-19	67207-19
20	67201-20	67205-20	67206-20	67207-20
21			67206-21	67207-21
22	67201-22	67205-22	67206-22	67207-22
23			67206-23	67207-23
24	67201-24	67205-24	67206-24	67207-24
25			67206-25	67207-25
26	67201-26	67205-26	67206-26	67207-26
27			67206-27	67207-27
28	67201-28	67205-28	67206-28	67207-28
29			67206-29	67207-29
30	67201-30	67205-30	67206-30	67207-30
32	67201-32	67205-32		
34	67201-34	67205-34		
36	67201-36	67205-36		
38		67205-38		
40		67205-40		

Metallkatheter
 Metal Catheters
 Sondas metálicas
 Sonde metalliche

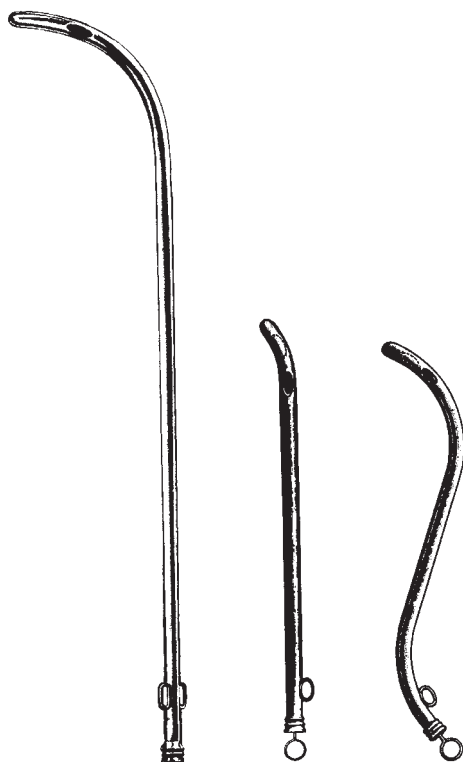

29 cm
 11 1/2"

15 cm
 6"

COXETER

Charr.	67211-06		67213-06		67219-08	
FG	67211-08		67213-08		67219-10	
	67211-10		67213-10		67219-12	
	67211-12		67213-12		67219-14	
	67211-14		67213-14		67219-16	
	67211-16		67213-16		67219-18	
	67211-18		67213-18		67219-20	
	67211-20		67213-20		67219-22	
	67211-22		67213-22		67219-24	
	67211-24		67213-24			

Beschneidungsinstrument
Circumcision Instrument
Instrumentos para circuncisión
Strumenti per circoncisione

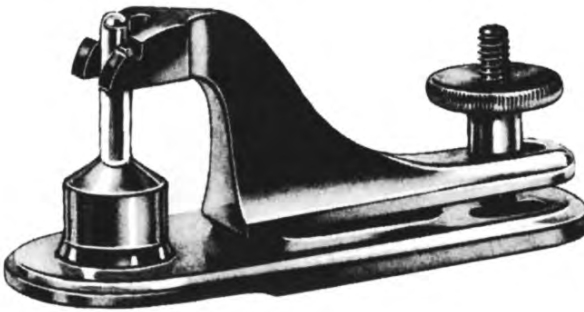

67240-08	8 mm Ø
67240-11	11 mm Ø
67240-13	13 mm Ø
67240-16	16 mm Ø
67240-21	21 mm Ø
67240-26	26 mm Ø
67240-32	32 mm Ø

67240-08 - 67240-32



MOGEN

67250-07	7,5 cm (3")	2,5 mm
67251-07	7,5 cm (3")	1,5 mm
		für Kinder
		for children
		para niños
		per bambini



Mastdarm-Spekula
Rectal Specula
Espécules rectales
Specoli rettali



CZERNY
69105-22
22 cm, 8 3/4"



SIMS
69110-15
15 cm, 6"



BODENHAMMER
69115-15
15 cm, 6"

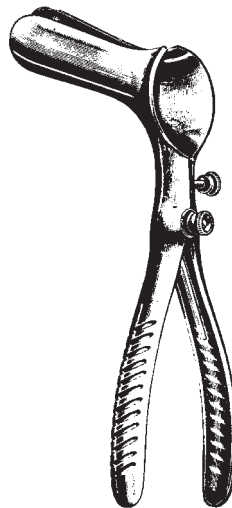

PRATT
69121-00
19 cm, 7 1/2"

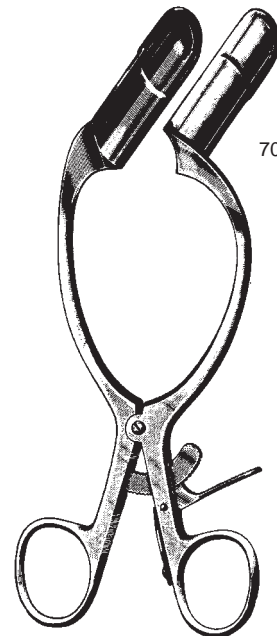

BARR
69125-17
17 cm, 6 3/4"

Mastdarm-Spekula
Rectal Specula
Espéculos rectales
Specoli rettali



HILL-FERGUSON, 20 cm, 8"
69126-01 6,4x2,2 cm 2 1/2" x 7/8"
69126-02 7,6x3,0 cm 3" x 1 3/16"
69126-03 7,6x3,6 cm 3" x 1 7/16"



SAWYER, 25 cm, 9 3/4"
69127-01 6,4x2,2 cm 2 1/2" x 7/8"
69127-02 7,6x2,9 cm 3" x 1 1/8"
69127-03 8,9x3,8 cm 3 1/2" x 1 1/2"



MATHIEU
69130-19
19,5 cm, 7 3/4"



SCHULZE-BERGMANN
69142-06 - 69142-12

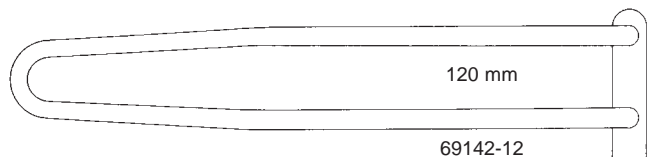
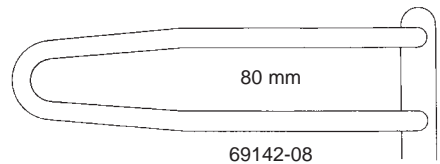
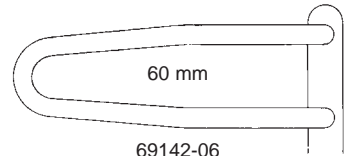

Analpreizer
 Anal Retractors
 Separadores rectales
 Dilatatori per l'ano e il retto

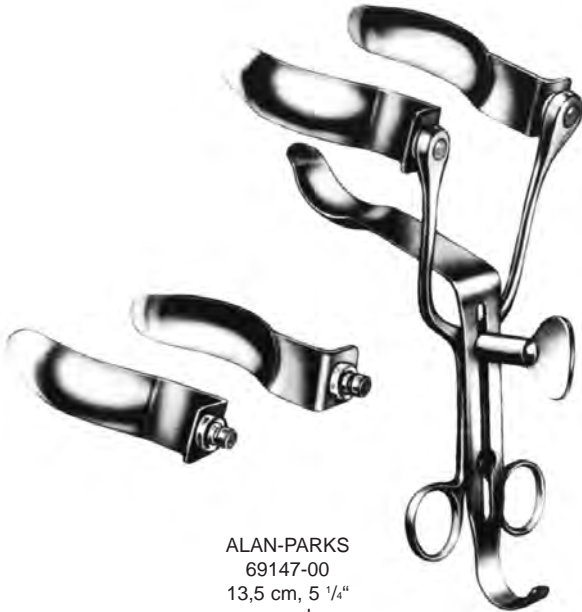

ALAN-PARKS
 69147-00
 13,5 cm, 5 1/4"
 compl.

69147-02 Mittelblatt allein
 Center blade, only
 Valva central, solo
 Valva centrale, sola

69147-03 Blatt allein 75 mm, 3"
 Blade only 75 mm, 3"
 Valva sola 75 mm, 3"
 Valva sola 75 mm, 3"

69147-04 Blatt allein 95 mm, 3 3/4"
 Blade only 95 mm, 3 3/4"
 Valva sola 95 mm, 3 3/4"
 Valva sola 95 mm, 3 3/4"

69148-00
 Kaltlicht Zubehör für 69147-00
 Cold Light Attachment for 69147-00
 Adaptador para luz fría 69147-00
 Adattatore luce fredda per 69147-00

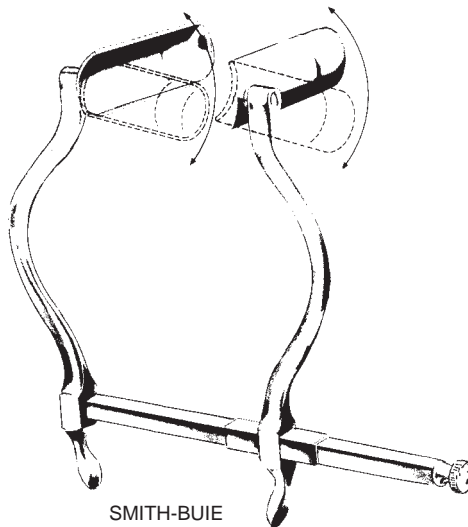

SMITH-BUIE
 69150-15
 15 cm, 6"
 75x23 mm

Anuskope, Proktoskope
 Anoscopes, Proctoscopes
 Anoscopios, Proctoscopios
 Anoscopi, Protoscopi

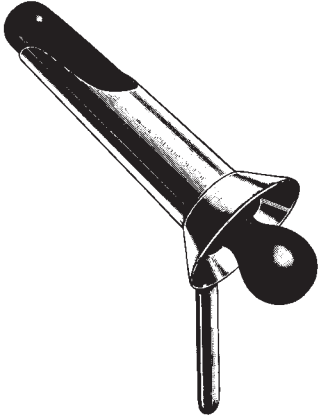

IVES-FANSLER
 69210-22 22 mm Ø
 L = 80 mm



Ø mm	HIRSCHMANN
16	69212-16
19	69212-19
22	69212-22
	L = 65 mm



mm	
ØxL	KELLY
22x 50	69220-05
22x100	69220-10
22x140	69220-14
22x200	69220-20

Anuskope, Proktoskope, Fistelsonde
 Anoscopes, Proctoscopes, Fistula Probe
 Anoscopios, Proctoscopios, Sondas para fistulas
 Anoscopi, Protoscopi, Sonde per fistole



Ø mm KELLY
 21 69224-21
 27 69224-27
 L = 50 mm, 2"

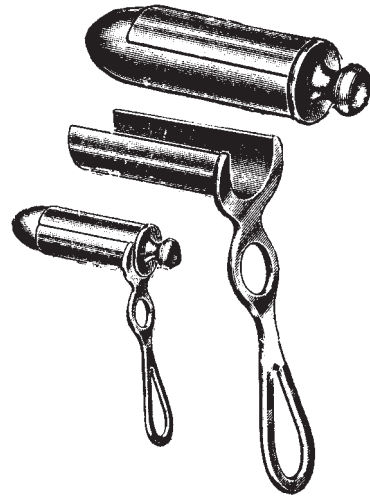

Ø mm CHELSEA-EATON
 22 x 65 69225-22
 30 x 65 69225-30



Fig. 1
 69251-01

Fig. 2
 69251-02

Fig. 3
 69251-03

PRATT
 21 cm, 8 1/4"
 69251-01 - 69251-03

Proktoskope
Proctoscopes
Proctoscopios
Protoscopi

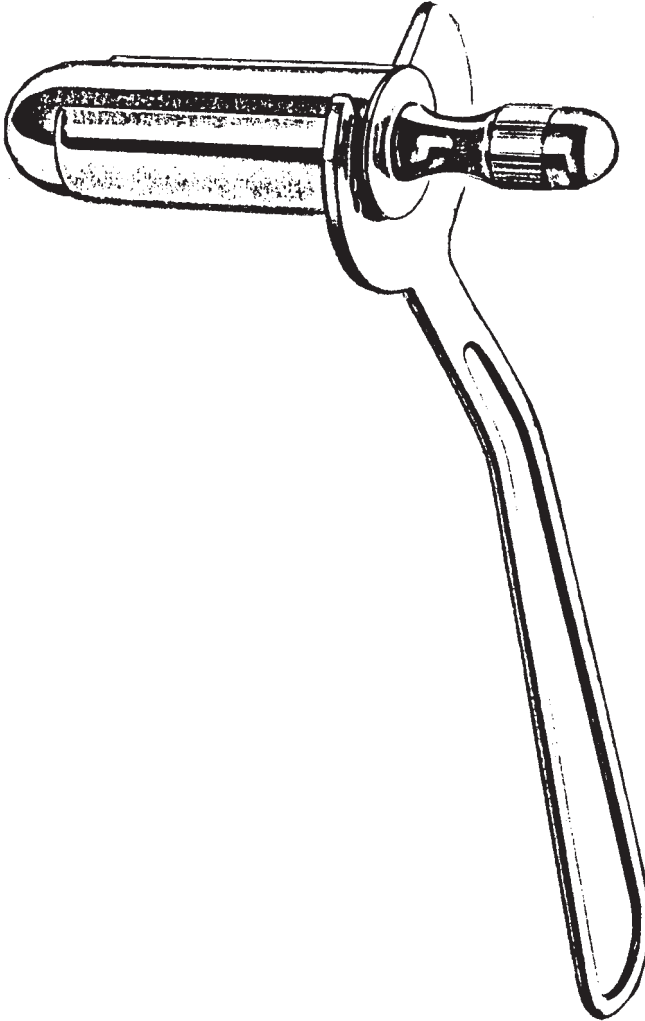

Ø	FANSLER, 24 cm, 9 1/2"
65 x 25 mm	69226-25
65 x 29 mm	69226-29
70 x 38 mm	69226-38

Proktoskope
Proctoscopes
Proctoscopios
Protoscopi

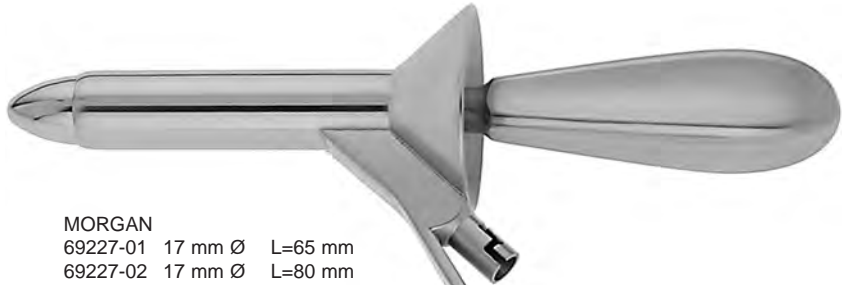
**MORGAN**

69227-01	17 mm Ø	L=65 mm
69227-02	17 mm Ø	L=80 mm
69227-03	20 mm Ø	L=65 mm
69227-04	20 mm Ø	L=80 mm
69227-05	24 mm Ø	L=65 mm
69227-06	24 mm Ø	L=80 mm

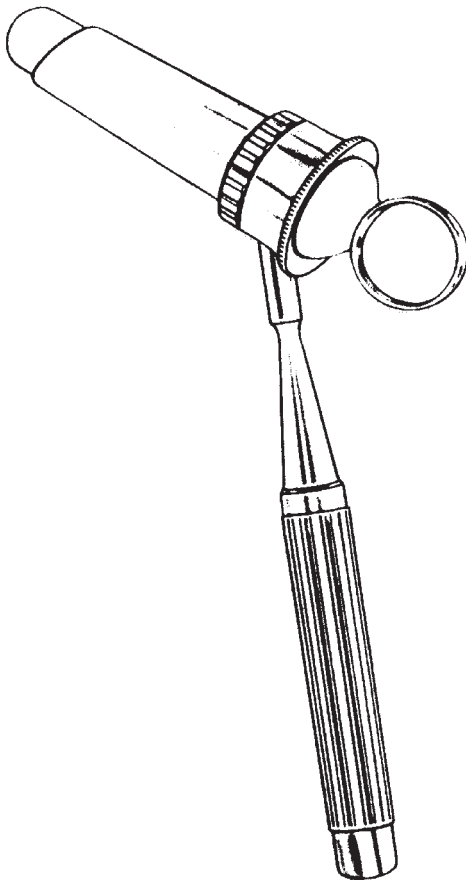
**BENSAUDE**

69229-01	19 mm Ø	L=70 mm
69229-02	22 mm Ø	L=70 mm



69228-01

Beleuchtungsstab für Morgan
Illumination attachment for Morgan
Mango con iluminación para Morgan
Dispositivo Illuminativo per Morgan

Rektal Absaugrohr, Rektalschnürer, Mastdarmbiopsiezangen
 Rectal aspiration cannula, Rectal snare, Rectal Biopsy Specimen Forceps
 Cánula de aspiración rectal, Cierra-nudo rectal, Pinzas para biopsia rectal
 Cannula d'aspirazione rettale, Serranodi, Pinze taglianti per biopsia rettale



BUIE
 69261-41
 41 cm, 16"

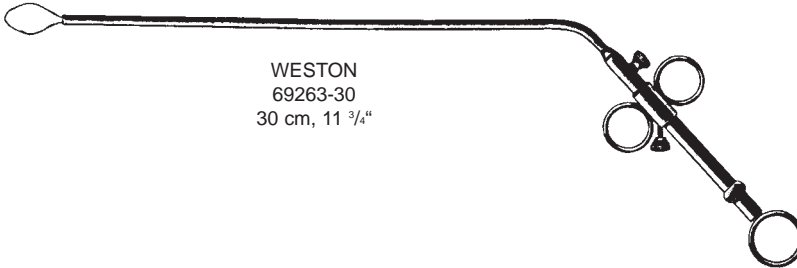

WESTON
 69263-30
 30 cm, 11 3/4"

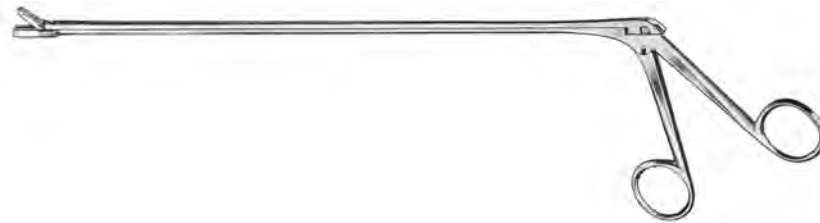

YEOMAN
 69301-28 - 69304-42

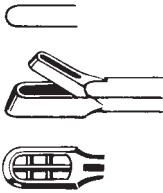

Fig. 1
 69301-28 28 cm, 11"
 69301-35 35 cm, 13 3/4"
 69301-42 42 cm, 16 1/2"

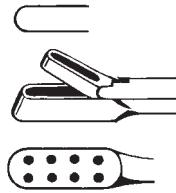

Fig. 2
 69302-28 28 cm, 11"
 69302-35 35 cm, 13 3/4"
 69302-42 42 cm, 16 1/2"

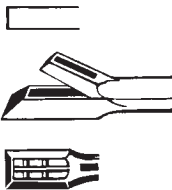

Fig. 3
 69303-28 28 cm, 11"
 69303-35 35 cm, 13 3/4"
 69303-42 42 cm, 16 1/2"

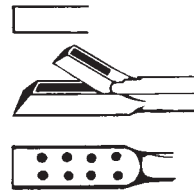
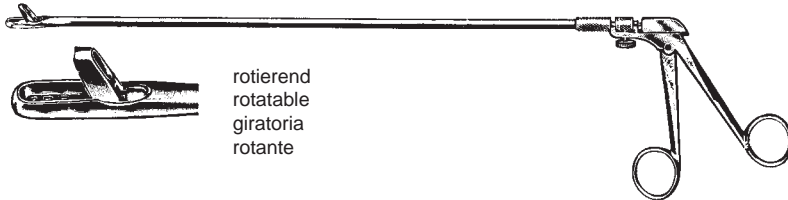

Fig. 4
 69304-28 28 cm, 11"
 69304-35 35 cm, 13 3/4"
 69304-42 42 cm, 16 1/2"

Mastdarm-Biopsiezangen rotierend, Hämorrhoidalzange
 Rectal Biopsy Specimen Forceps rotatable, Haemorrhoidal Forceps
 Pinzas para biopsia rectal, giratoria, Pinzas-clamps hemorroidales
 Pinze taglianti per biopsia rettale, rotante, Pinze per emorroidi



rotierend
 rotatable
 giratoria
 rotante

YEOMANN

- 69311-23 23 cm, 9"
- 69311-33 33 cm, 13"
- 69311-40 40 cm, 15 3/4"

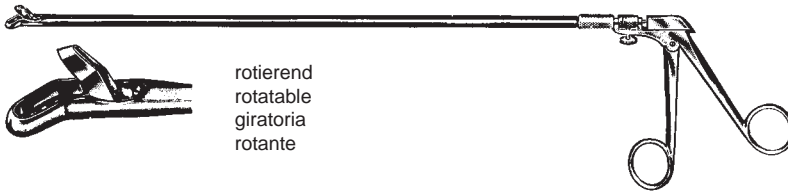

rotierend
 rotatable
 giratoria
 rotante

TURREL

- 69321-23 23 cm, 9"
- 69321-33 33 cm, 13"
- 69321-40 40 cm, 15 3/4"

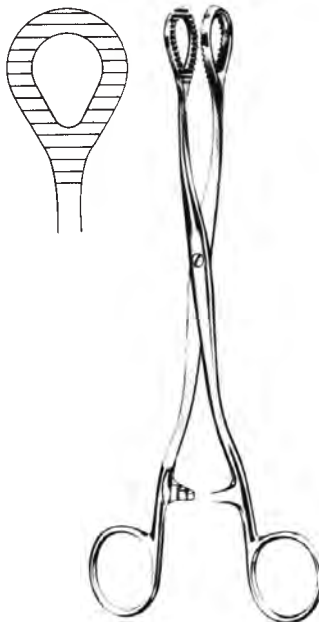

HEYWOOD-SMITH

- 69402-21 21 cm, 8 1/4"
- 69402-25 25 cm, 10"

Hämorrhoidal-Ligatoren, Hämorrhoidalzangen
 Haemorrhoidal Ligators, Haemorrhoidal Forceps
 Ligadores para hemorroides, Pinzas-clamps para hemorroides
 Legatori emorroidali, Pinze per emorroidi

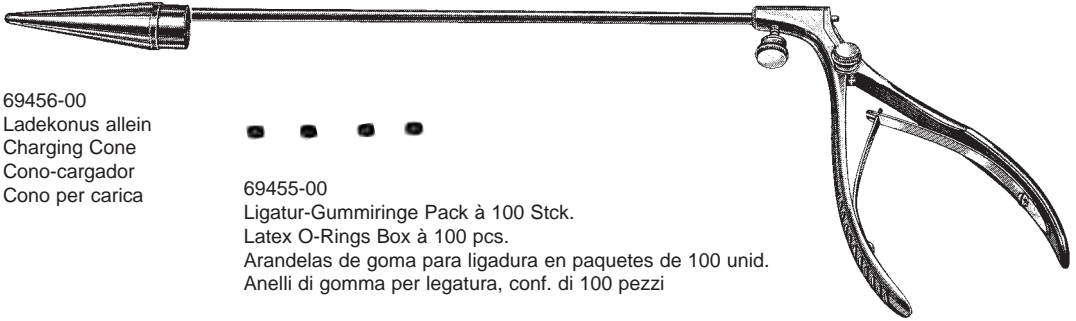

69456-00
 Ladekonus allein
 Charging Cone
 Cono-cargador
 Cono per carica



69455-00
 Ligatur-Gummiringe Pack à 100 Stck.
 Latex O-Rings Box à 100 pcs.
 Arandelas de goma para ligadura en paquetes de 100 unid.
 Anelli di gomma per legatura, conf. di 100 pezzi

MC GIVNEY
 LI GATOR
 69450-18
 18 cm, 7"



69457-12
 Ø 12 mm

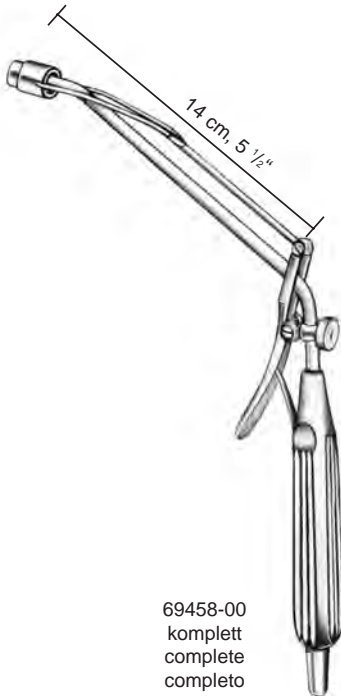

69458-00
 komplett
 complete
 completo



Ø 10 mm
 69458-10
 Ladekonus
 Charging cone
 Cono-cargador
 Cono per carica



Ø 10 mm
 69458-11 11 mm
 69458-16 16 mm
 Saugkopf
 Aspiration tip
 Cabeza de aspiración
 Testa d'aspirazione



RUDD
 69457-31
 31,5 cm, 12 1/2"
 kplt./cplt.

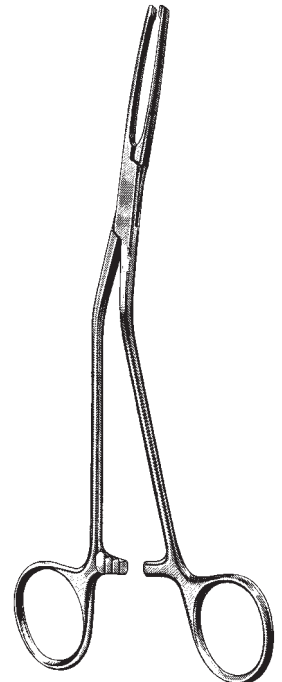

MC GIVNEY
 69460-00
 19 cm, 7 1/2"

Lateral-Scheidenspekula
 Lateral Vaginal Retractor
 Espéculos vaginales
 Specoli vaginali



71100-00

Lateralspreizer allein
 Vaginal retractor lateral only
 Espéculo vaginal solo
 Specolo vaginale laterale, solo

VU-MORE

Fig.	mm	
2	95x35	71115-02
3	115x35	71115-03

Scheidenspekula
Vaginal Specula
Espéculos vaginales
Specoli vaginali

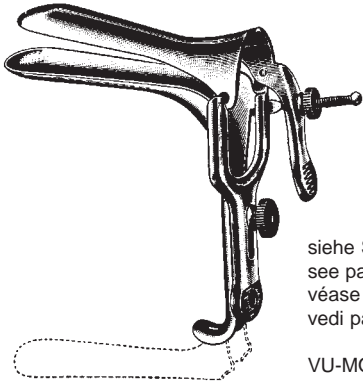

siehe Seite 569
see page no. 569
véase pagina no. 569
vedi pagina nr. 569

VU-MORE

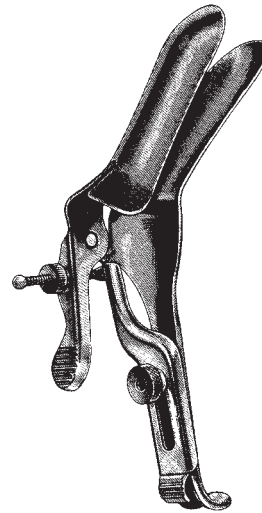

rechts offen
open right-side
abierto a la derecha
aperta a destra

GRAVE

Fig.	mm	Standard
1	75x20	71110-01
2	95x35	71110-02
3	115x35	71110-03

GRAVE

71116-02
mittel, medium, mediano, medio
101x35 mm

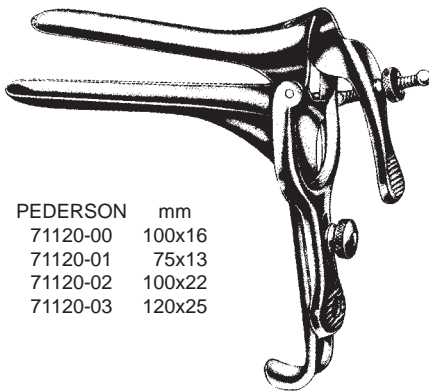

Fig.	PEDERSON	mm
	71120-00	100x16
1	71120-01	75x13
2	71120-02	100x22
3	71120-03	120x25

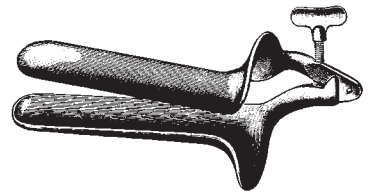
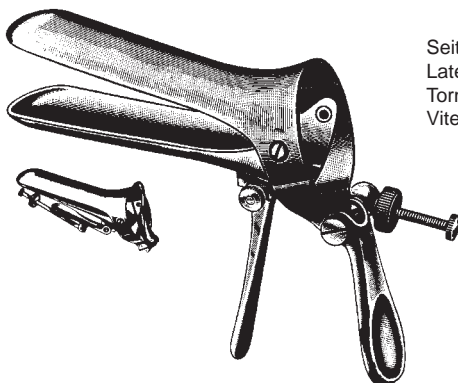

Fig.	COLLIN	mm
1	71130-01	85x30
2	71130-02	100x35
3	71130-03	110x40



Seitliche Schraube
Lateral Screw
Tornillo lateral
Vite laterale

CUSCO

Fig.	mm	Standard
1	75x32	71140-01
2	85x35	71140-02
3	100x35	71140-03
4	75x17	71142-04

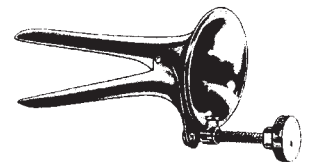

COLLIN
71132-00
65x10 mm

für Jungfrauen
for virgins
para vírgenes
per vergini

Scheidenspekula
 Vaginal Specula
 Espécules vaginales
 Specoli vaginali

Mittelschraube
 Central Screw
 Tornillo central
 Vite centrale

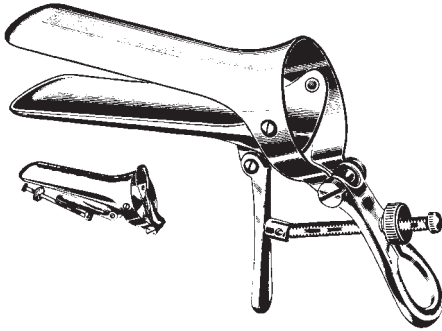

Fig.	CUSCO	mm
1	71150-01	75x32
2	71150-02	85x35
3	71150-03	100x37

Schweizer Modell
 Swiss Pattern
 Modelo suizo
 Modello svizzero

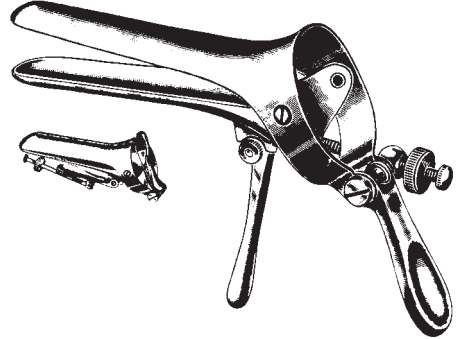
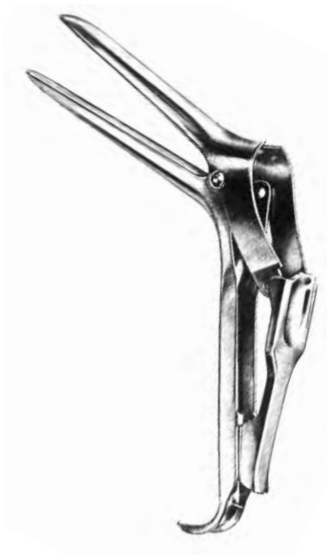

Fig.	CUSCO	mm
1	71160-01	90x23-25
2	71160-02	100x25-27
3	71160-03	110x27-30



	SEMM	mm
71161-17	100 x 17 - 20 mm	
71161-25	100 x 25 - 30 mm	

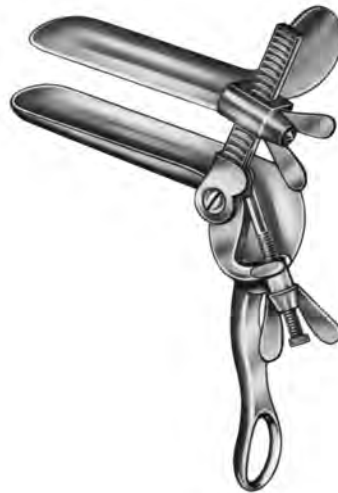

Fig.	TRÉLAT	mm
1	71170-01	85x33
2	71170-02	95x35
3	71170-03	115x43

Scheidenspekula
Vaginal Specula
Espéculos vaginales
Specoli vaginali

Satz bestehend aus je 1 Spekula und 1 Halter
Set consisting of 1 specula and 1 retractor
Juego de 1 espéculo y 1 valva
Serie da 1 specolo e 1 valva

Spekula
Speculum
Espéculo
Specolo

Halter
Retractor
Valva
Valve



Fig. KRISTELLER
1 71210-01
2 71210-02
3 71210-03

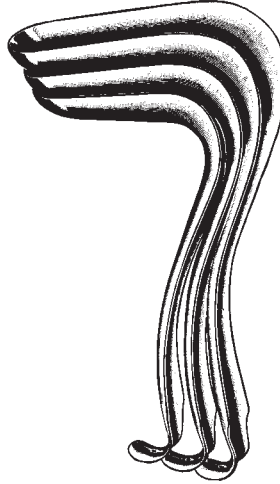

Fig. KRISTELLER mm
1 71211-01 70x27
2 71211-02 80x30
3 71211-03 90x36



Fig. KRISTELLER mm
1 71212-01 75x23
2 71212-02 85x26
3 71212-03 100x32



Fig. KRISTELLER
00 71240-00
0 71240-10
1 71240-01
2 71240-02
3 71240-03

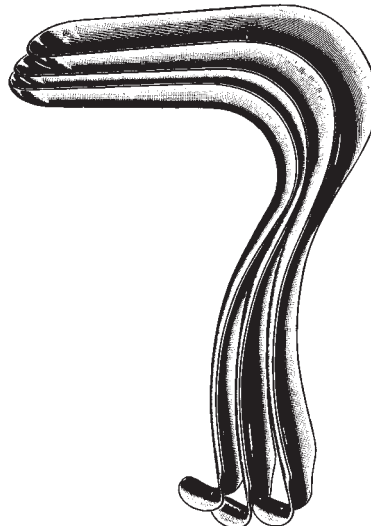

Fig. KRISTELLER mm
00 71241-00 110x18
0 71241-10 110x21
1 71241-01 110x27
2 71241-02 110x30
3 71241-03 110x36

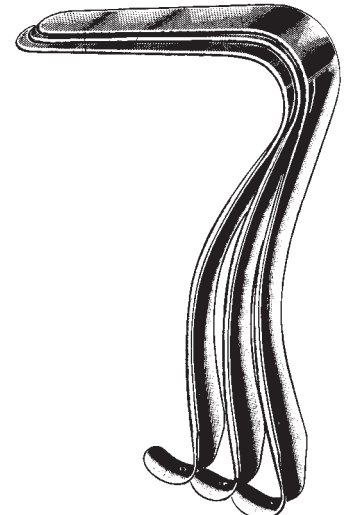

Fig. KRISTELLER mm
00 71242-00 115x14
0 71242-10 115x17
1 71242-01 115x23
2 71242-02 115x26
3 71242-03 115x32

Scheidenspekula
Vaginal Specula
Espéculos vaginales
Specoli vaginali



KALLMORGEN
71260-01 - 71262-02

Fig.	Serie	Spekula Speculum Espéculo Specolo	Halter Retractor Valva	mm	Valve	mm
1	71260-01	71261-01	70x40	71262-01	70x33	
2	71260-02	71261-02	90x40	71262-02	90x33	

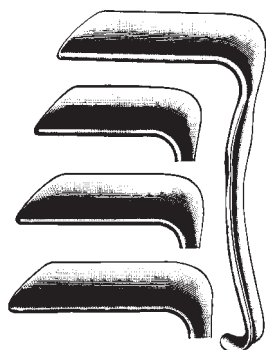

Fig.	Serie	mm
1	71271-01	75x38
2	71271-02	90x38
3	71271-03	100x38



Fig.	Serie	mm
1	71281-01	63x32
2	71281-02	76x32
3	71281-03	89x38

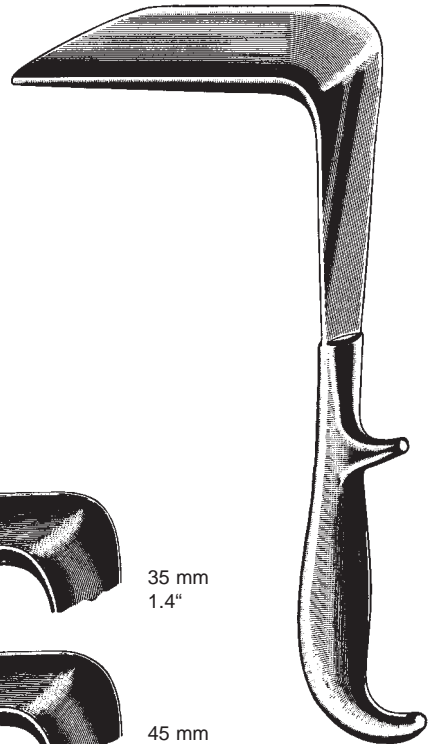

Fig.	Serie	mm
1	71291-01	60x25+30
2	71291-02	70x30+35
3	71291-03	80x35+40
Set	71291-00	(Fig. 1,2,3)

Scheidenspekula
Vaginal Specula
Espéculos vaginales
Specoli vaginali



DELEE
71300-01
23,5 cm, 9 1/4"



DOYEN
24 cm, 9 1/2"

leicht hohl
slightly concave
ligeramente concavos
leggermente concavi

Fig.		mm
1	71301-01	55x35
2	71301-02	85x35
3	71301-03	115x35



35 mm
1.4"

Fig.		mm
1	71303-01	55x45
2	71303-02	85x45
3	71303-03	115x45
4	71303-04	160x45
5	71303-05	180x45



45 mm
1.8"

Fig.		mm
1	71305-01	55x60
2	71305-02	85x60
3	71305-03	115x60
4	71305-04	160x60
5	71305-05	180x60



60 mm
2.4"

Scheidenspekula
 Vaginal Specula
 Espéculos vaginales
 Specoli vaginali



71306-01 - 71306-03

71306-01
 80 x 30 mm

71306-02
 85 x 35 mm

71306-03
 90 x 40 mm

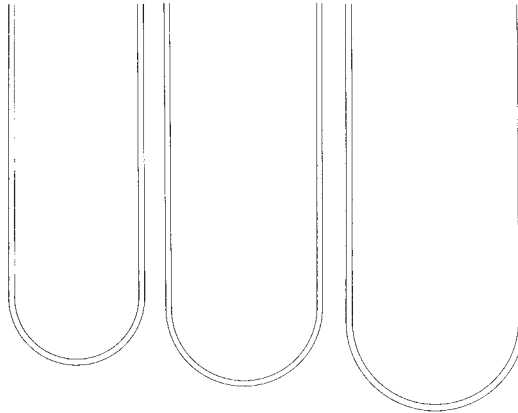

71306-04
 Gewicht 400 gr
 weight 400 grs
 peso 400 grs
 peso 400 grs

71306-05
 Gewicht 800 gr
 weight 800 grs
 peso 800 grs
 peso 800 grs

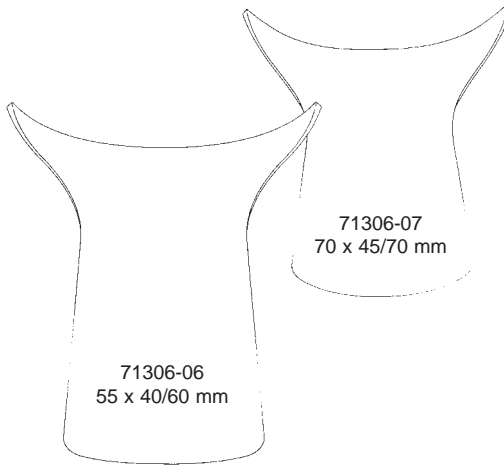

71306-06
 55 x 40/60 mm

71306-07
 70 x 45/70 mm

SCHERBAK
 71306-00
 Set komplett
 complete set
 juego completo
 set completo



71306-08
 Griff, handle,
 mango, manico

Scheidenspekula
Vaginal Specula
Espéculos vaginales
Specoli vaginali



O'SULLIVAN-O'CONNOR
71308-00



Fig. 1 = 45 x 17 mm 71308-01
Fig. 2 = 90 x 37 mm 71308-02
Fig. 3 = 90 x 45 mm 71308-03

71308-00

komplett bestehend aus:

1 Rahmen mit 2 beweglichen Seitenvälven
3 austauschbare Mittelvälven Fig. 1-3

1 frame with 2 mobile lateral blades
3 interchangeable blades Fig. 1-3

1 Marco con 2 separadores móviles laterales
3 separadores centrales intercambiables fig. 1-3

1 telaio regolabile con 2 valve laterali mobili
3 valve intercambiabili fig. 1-3

71308-04
Rahmen allein
Frame only
Marco solo
Telaio solo

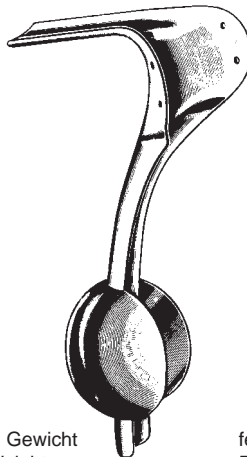

abnehmbares Gewicht
Detachable Weight
Peso desmontable
Peso smontabile

71307-00
1,4 kg
75 x 38 mm

AUVARD
24 cm, 9 1/2"

festes Gewicht
Fixed Weight
Peso fijo
Peso fisso

71309-00
1,4 kg
105 x 38 mm

Scheidenspekula, Endospekula
 Vaginal Specula, Endospekula
 Espéculos vaginales, Endo-espéculos
 Specoli vaginali, Endospecoli

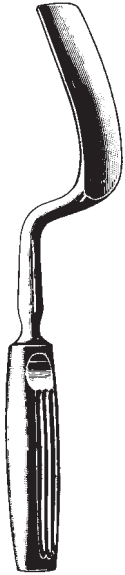

mm	BREISKY	
100x20	71310-20	28 cm, 11"
100x25	71310-25	28 cm, 11"
100x30	71310-30	28 cm, 11"
100x35	71310-35	28 cm, 11"
100x40	71310-40	28 cm, 11"
130x20	71313-20	33 cm, 13"
130x25	71313-25	33 cm, 13"
130x30	71313-30	33 cm, 13"
130x35	71313-35	33 cm, 13"
130x40	71313-40	33 cm, 13"
155x40	71315-40	35 cm, 13 3/4"



mm	LANDAU	
100x28	71319-28	29 cm, 11 1/2"
100x38	71319-38	29 cm, 11 1/2"

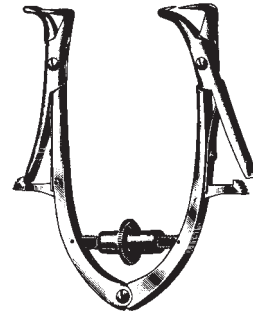

FRIEDMANN	
71351-15	15 cm, 6"



KOGAN		
71360-24	3 mm	24 cm, 9 1/2"
71361-24	4 mm	24 cm, 9 1/2"
71362-24	5 mm	24 cm, 9 1/2"



KOGAN		
71363-24	3 mm	24 cm, 9 1/2"
71364-24	4 mm	24 cm, 9 1/2"
71365-24	5 mm	24 cm, 9 1/2"

Uterus Dilatatoren
 Uterine Dilators
 Dilatadores uterinos
 Dilatatori uterini

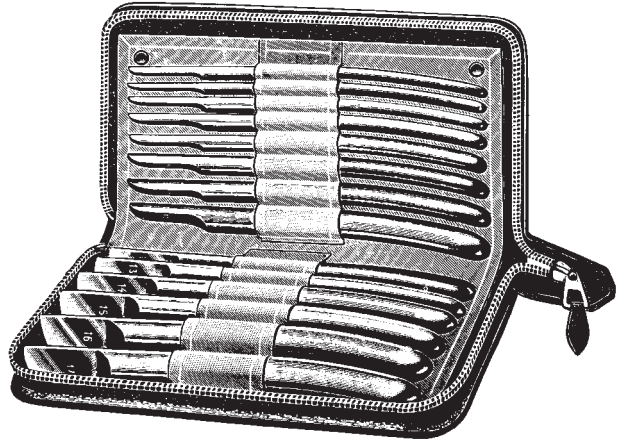

mm Ø	HEGAR		mm Ø
1	71410-01	71415-01	1,5
2	71410-02	71415-02	2,5
3	71410-03	71415-03	3,5
4	71410-04	71415-04	4,5
5	71410-05	71415-05	5,5
6	71410-06	71415-06	6,5
7	71410-07	71415-07	7,5
8	71410-08	71415-08	8,5
9	71410-09	71415-09	9,5
10	71410-10	71415-10	10,5
11	71410-11	71415-11	11,5
12	71410-12	71415-12	12,5
13	71410-13	71415-13	13,5
14	71410-14	71415-14	14,5
15	71410-15	71415-15	15,5
16	71410-16	71415-16	16,5
17	71410-17	71415-17	17,5
18	71410-18	71415-18	18,5
19	71410-19	71415-19	19,5
20	71410-20		
21	71410-21		
22	71410-22		
23	71410-23		
24	71410-24		
25	71410-25		
26	71410-26		
27	71410-27		
28	71410-28		
29	71410-29		
30	71410-30		

HEGAR
 71405-14 4-17 mm
 14 St./pces./pzas./pezzi

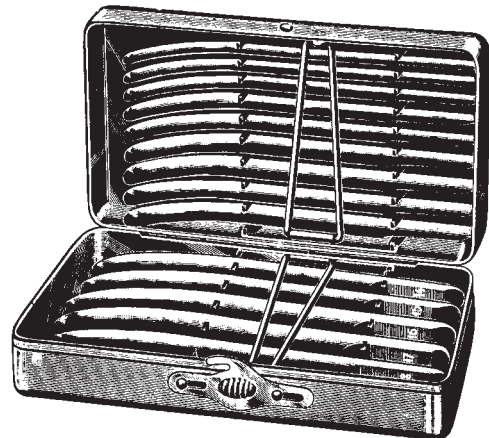

mm HEGAR
 4-17 71406-14 14 St./pces./pzas./pezzi
 1-26 71406-26 26 St./pces./pzas./pezzi

71404-14 Satz/Set/Juego/Set
 71410-04 - 71410-17 = 14
 71404-26 Satz/Set/Juego/Set
 71410-01 - 71410-26 = 26

in Metalletui, in metal case,
 en estuche de metal, in astuccio metallico

Uterus Dilatatore
 Uterine Dilators
 Dilatadores uterinos
 Dilattatori uterini

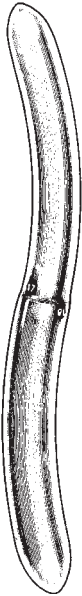

mm	HEGAR
1/ 2	71420-01
3/ 4	71420-03
5/ 6	71420-05
7/ 8	71420-07
9/10	71420-09
11/12	71420-11
13/14	71420-13
15/16	71420-15
17/18	71420-17
19/20	71420-19
21/22	71420-21
23/24	71420-23
25/26	71420-25

71424-08 Satz/Set/Juego/Set
 71420-03 - 71420-17 = 8
 3/4 - 17/18 mm

71424-13 Satz/Set/Juego/Set
 71420-01 - 71420-25 = 13
 1/2 - 25/26 mm

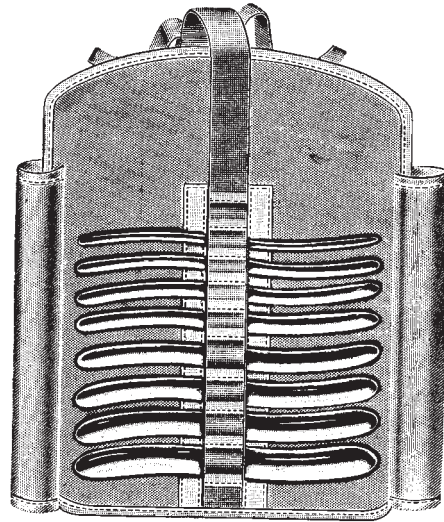

mm HEGAR
 3/4 - 17/18 71425-08 8 St./pces./pzas./pezzi

in Stofftasche, in khaki roll,
 en bolsa de tela, in borsa di tela

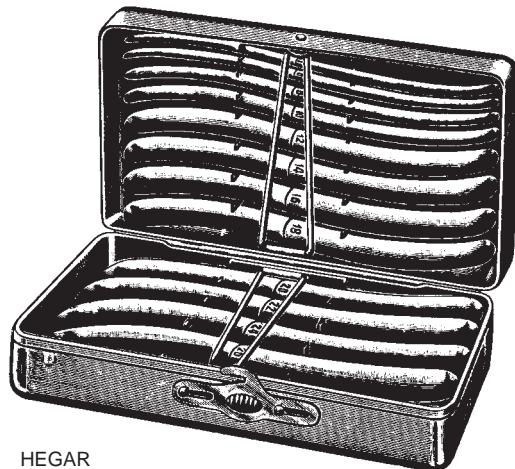

mm HEGAR
 3-4 - 17/18 71426-08 8 St./pces./pzas./pezzi
 1/2 - 25/26 71426-13 13 St./pces./pzas./pezzi

in Metalletui, in metal case,
 en estuche de metal, in astuccio metallico

Uterus Dilatatore
 Uterine Dilators
 Dilatadores uterinos
 Dilatatori uterini

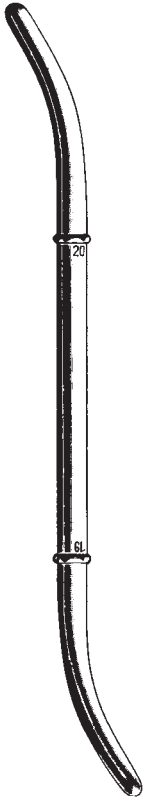

in Stofftasche
 in khaki roll
 en bolsa de tela
 in borsa di tela

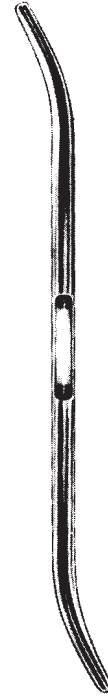
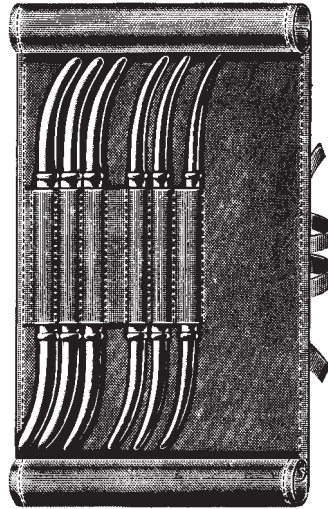

mm	HANK	Fig./U.S.
4,5/ 5	71430-10	9/10
5,5/ 6	71430-12	11/12
6,5/ 7	71430-14	13/14
7,5/ 8	71430-16	15/16
8,5/ 9	71430-18	17/18
9,5/10	71430-20	19/20

71435-06 Satz, Set, Juego, Serie = 6

HANK
 71436-08
 Satz, Set, Juego, Serie = 6

PRATT		
71438-13 - 71438-41		
71438-00		
Satz, Set, Juego, Set = 8		
size	mm	
71438-13	13-15	4,5/ 5,0
71438-17	17-19	5,6/ 6,3
71438-21	21-23	7,0/ 7,6
71438-25	25-27	8,3/ 9,0
71438-29	29-32	9,6/10,3
71438-33	33-35	11,0/11,6
71438-37	37-39	12,3/13,0
71438-41	41-43	13,6/14,3

Uterus Dilatorem
Uterine Dilators
Dilatadores uterinos
Dilatatori uterini

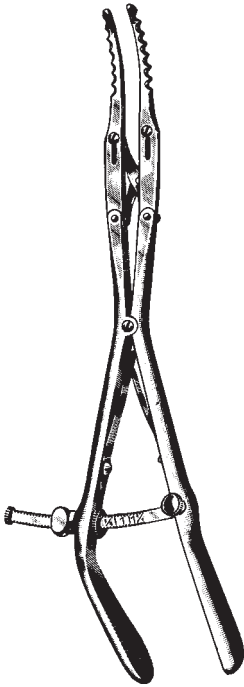

GOODELL
71441-34
34 cm, 13 1/2"

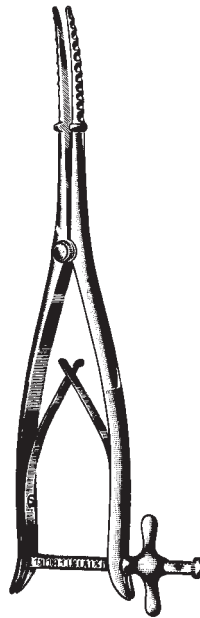

WYLIE
71443-29
29 cm, 11 1/2"

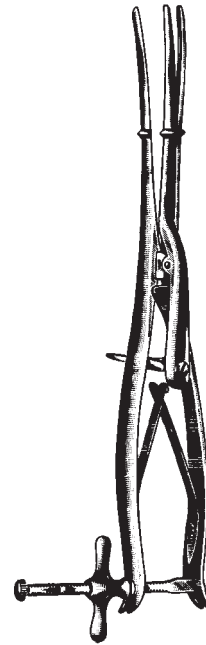

SIMS
71445-29
29 cm, 11 1/2"

Hakenzangen
 Tenaculum Forceps
 Pinzas para coger el cuello del útero
 Pinze per abbassare il collo dell'utero

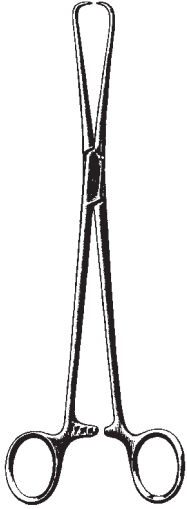

SCHRÖDER (POZZI)
 71502-25
 25 cm, 10"

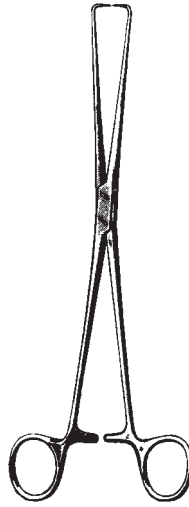

BRAUN
 71504-25
 25 cm, 10"



SKENE
 71505-24
 24 cm, 9 1/2"

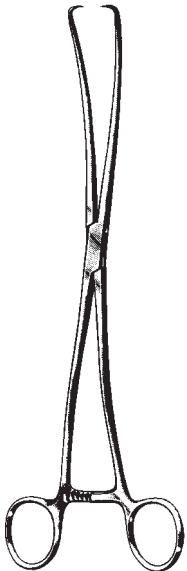

DUPLAY
 71507-28
 28 cm, 11"

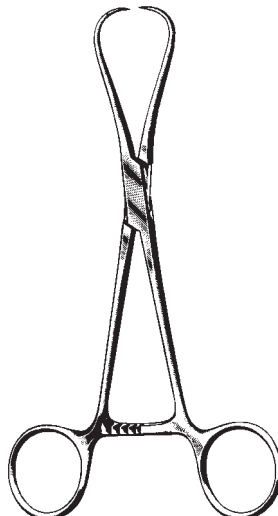

STAUDE-MOORE
 71508-17
 17 cm, 6 3/4"

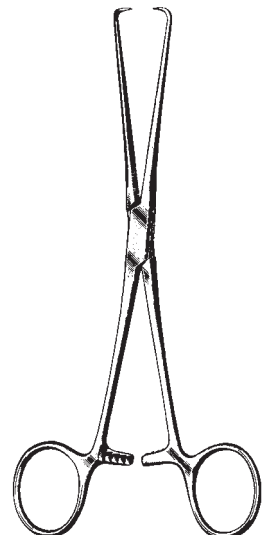

BARRETT
 71510-18
 18 cm, 7"

Hakenzangen
 Tenaculum Forceps, Vulsellum Forceps
 Pinzas para coger el cuello del útero
 Pinze per abbassare il collo dell'utero

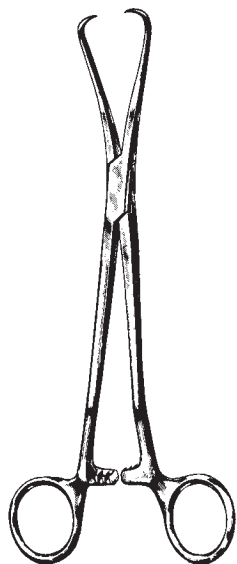

JARCHO
 71512-20
 20 cm, 8"

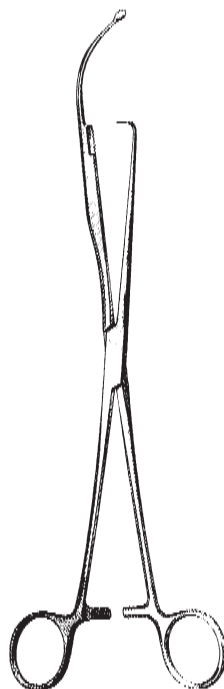

HULKA
 71512-28
 28 cm, 11"

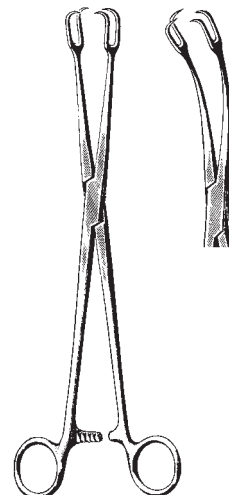

SCHRÖDER
 71514-24 71515-24
 24 cm, 9 1/2"

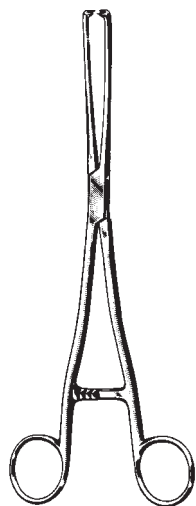

MUSEUX
 71524-06 6 mm 71525-06
 71524-08 8 mm 71525-08
 71524-10 10 mm 71525-10
 24 cm, 9 1/2"

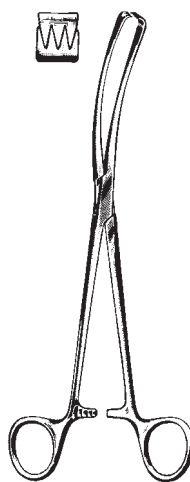

TEALE
 71531-23
 23 cm, 9"

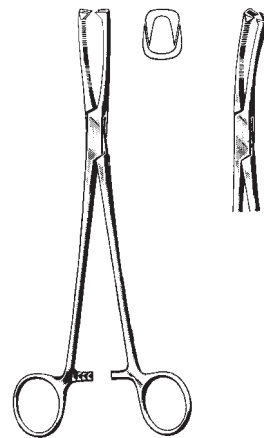

JACOBS
 71532-21 71533-21
 21 cm, 8 1/4"

Hakenzangen
 Tenaculum Forceps, Vulsellum Forceps
 Pinzas para coger el cuello del útero
 Pinze per abbassare il collo dell'utero

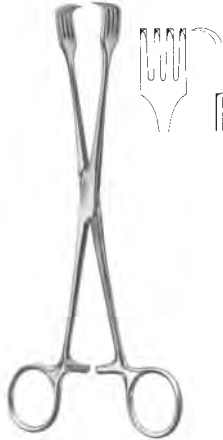

CZERNY
 71536-21
 20 cm, 8"



PRATT
 71536-28
 28 cm, 11"



SCHRÖDER
 71537-27
 27 cm, 10 1/2"

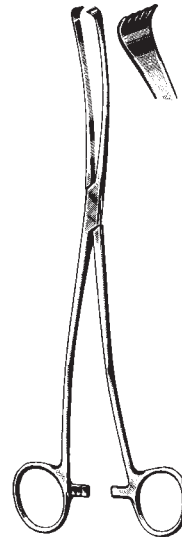

IOWA
 71539-26
 26 cm, 10 1/4"

Uterus Polypenzangen, Uterus-Faßzangen
 Uterine Polypus Forceps, Uterine Elevating Forceps
 Pinzas para pólipos uterinos, Pinzas para el útero
 Pinze per polipi uterini, Pinze per afferrare l'utero

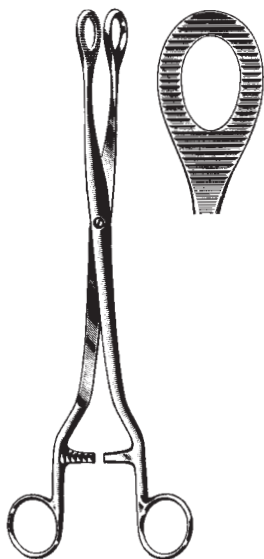

NOTO
 71540-27
 27 cm, 10 1/2"

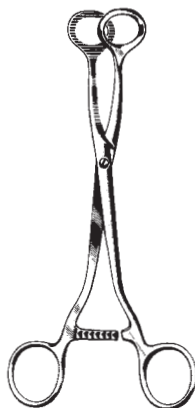

DOYEN
 71542-20
 20 cm, 8"

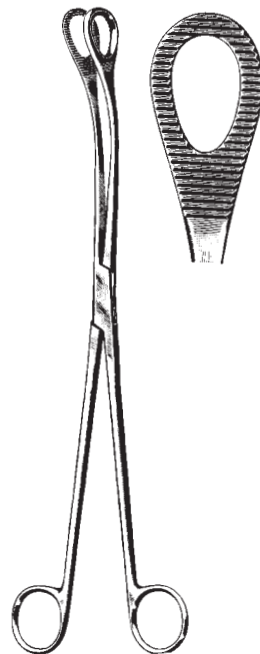

KELLY
 71543-32
 32 cm, 12 3/4"



DARTIGUES
 71545-27
 27 cm, 10 1/2"



SOMER
 71547-23
 23 cm, 9"

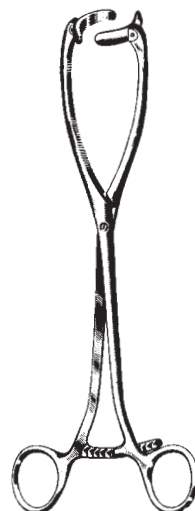

COLLIN
 71549-25
 25 cm, 10"

Amniotom, Uterus Depressoren, Uterus-Sonden
 Amniotome, Uterine Depressors, Uterine Sounds
 Amniótomo, Depresores uterinos, Histerómetros
 Amniotomo, Depressori uterini, Isterometri



BEACHAM
 71559-26
 26 cm, 10 1/4"



BRAUN
 71565-28
 28 cm, 11"



SIMS
 71567-26
 26 cm, 10 1/4"



fest
 rigid
 rigido
 rigida
 71580-32
 32 cm, 12 3/4"

biegsam
 malleable
 maleable
 malleabile
 SIMS
 71581-32



fest
 rigid
 rigido
 rigida
 71582-32
 32 cm, 12 3/4"

biegsam
 malleable
 maleable
 malleabile
 MARTIN
 71583-32



COLLIN
 71584-28
 28 cm, 11"



VALLEIX
 71585-25
 25 cm, 10"

Biopsie-Küretten
 Uterine Biopsy Aspirating Curettes
 Curetas aspiradoras p. la biopsia uterina
 Curette per biopsia



RANDALL
 71590-04
 24 cm, 9 1/2"
 Ø 4 mm

NOVAK
 71592-01 1 mm
 71592-02 2 mm
 71592-03 3 mm
 71592-04 4 mm

HEANY
 71593-00
 22,5 cm, 9"

KEVORKIAN
 4,0 mm
 30 cm, 11 3/4"
 ohne Korb
 without basket
 sin cesta
 senza cestello
 71594-40

mit Korb
 with basket
 con cesta
 con cestello
 71596-40

MOD. MUENCHEN
 71598-27
 27 cm, 10 1/2"

Biopsiezangen
 Biopsy Forceps
 Pinzas para biopsia
 Pinze taglienti per biopsia



SCHUMACHER
 24 cm, 9 1/2"



SCHUBERT
 71604-21 21 cm, 8 1/4"
 71604-28 28 cm, 11"

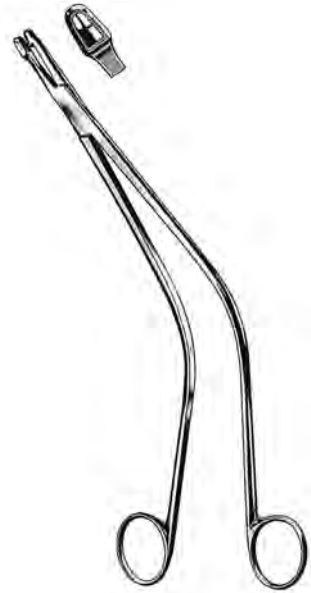

SCHUBERT
 71605-26
 26 cm, 10 1/4"



THOMAS-GAYLOR
 71606-24
 24 cm, 9 1/2"



van DOREN
 71611-25
 25 cm, 10"



FAURE
 71612-21
 21 cm, 8 1/4"

Uterus Biopsiezangen
 Biopsy Specimen Forceps
 Pinzas para biopsia
 Pinze per biopsia

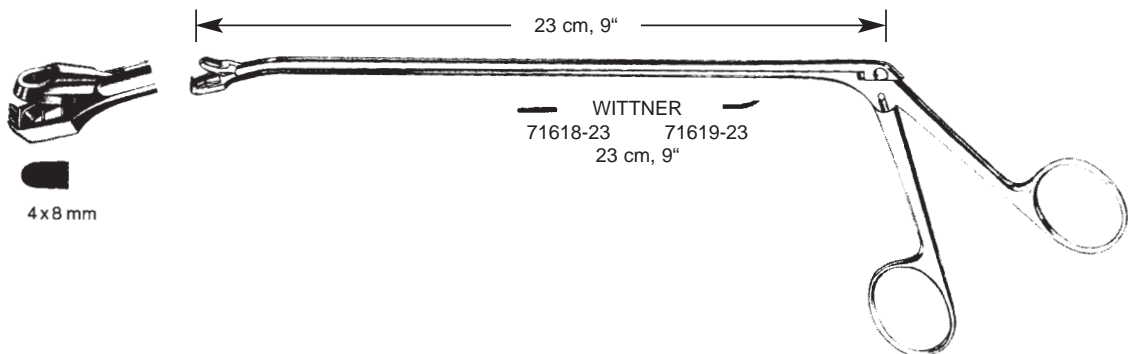
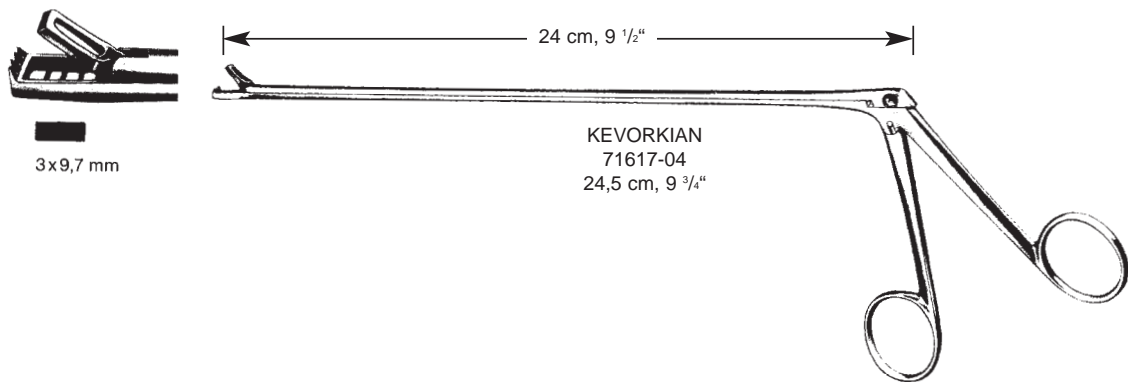
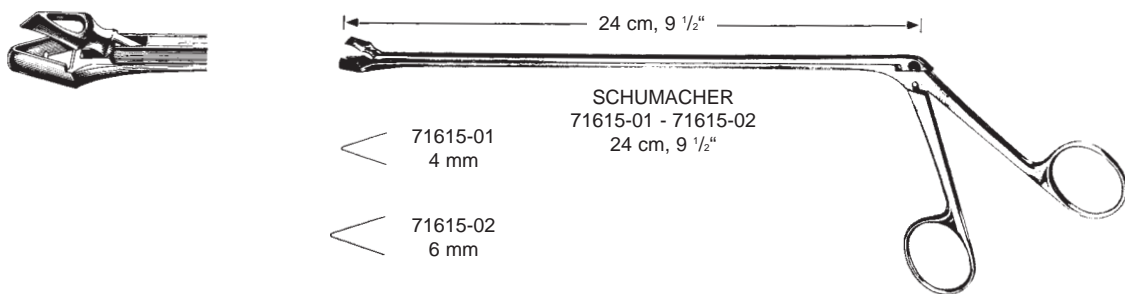
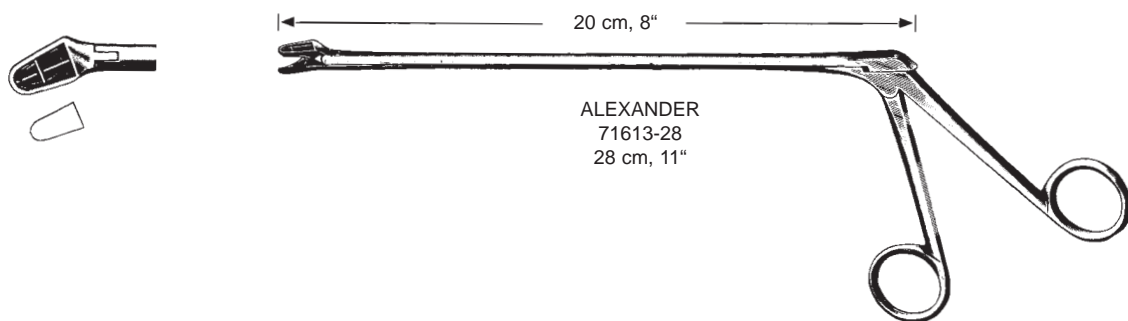

Uterus Biopsiezangen
 Biopsy Specimen Forceps
 Pinzas sacabocado p. biopsia
 Pinze per biopsia

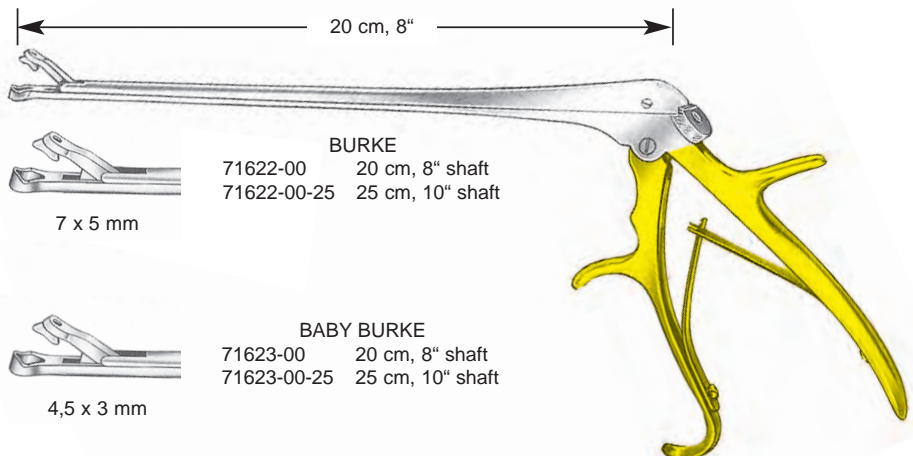
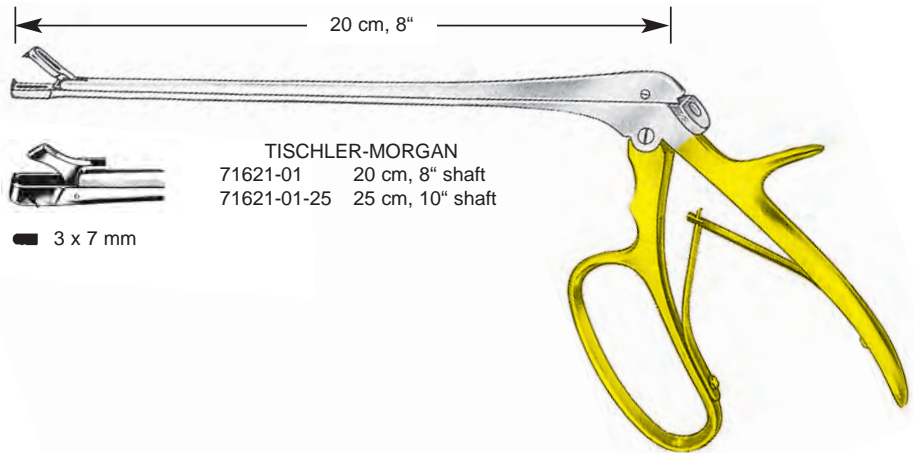
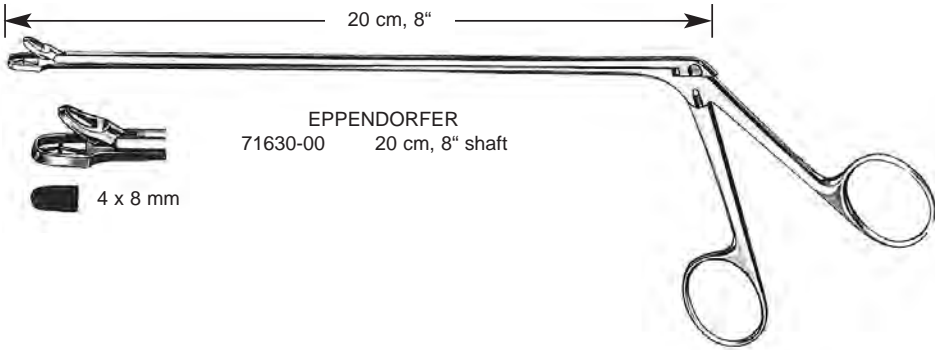

Uterus Biopsiezangen
 Biopsy Specimen Forceps
 Pinzas sacabocado p. biopsia
 Pinze per biopsia

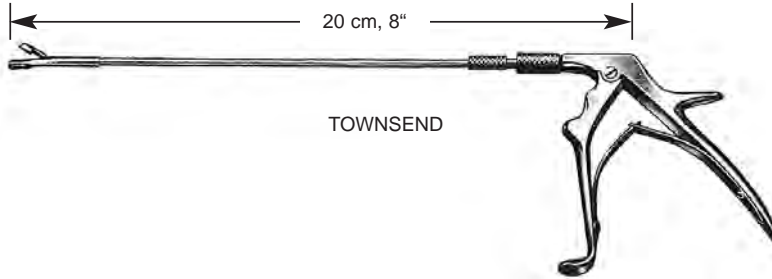

TOWNSEND

71624-10
 Griff allein
 Handle only
 Mango solo
 Manico solo



Fig. 1

TISCHLER-Morgan



Fig. 6

TISCHLER-UP



Fig. 3

oval ● 3,7x5 mm



Fig. 7

TISCHLER-DOWN



Fig. 4

KEVORKIAN



Fig. 8

MINI-TOWNSEND-UP



Fig. 5

mini



Fig. 9

MINI-TOWNSEND-DOWN

Fig.	Strumento completo	Asta operativa sola
1	71624-01	71624-11
3	71624-03	71624-13
4	71624-04	71624-14
5	71624-05	71624-15
6	71624-06	71624-16
7	71624-07	71624-17
8	71624-08	71624-18
9	71624-09	71624-19

komplett
 compl. instr.
 Instrum. compl.

Aufsatz allein
 Tip only
 Punta sola

Uterus Biopsiezangen
 Biopsy Specimen Forceps
 Pinzas sacabocado p. biopsia
 Pinze per biopsia



2,3 x 4,2 mm

20 cm, 8"

BABY-TISCHLER
 71626-00 20 cm, 8" shaft
 71626-00-25 25 cm, 10" shaft
 mit Sure-Lock



3 x 9,5 mm

TISCHLER-KEVORKIAN
 71627-00

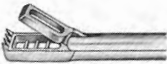

3 x 8 mm

20 cm, 8"

KEVORKIAN-PACIFIC
 71628-00 20 cm, 8" shaft
 71628-00-25 25 cm, 10" shaft
 mit Sure-Lock



Uterus Biopsiezangen
Biopsy Specimen Forceps
Pinzas sacabocado p. biopsia
Pinze per biopsia

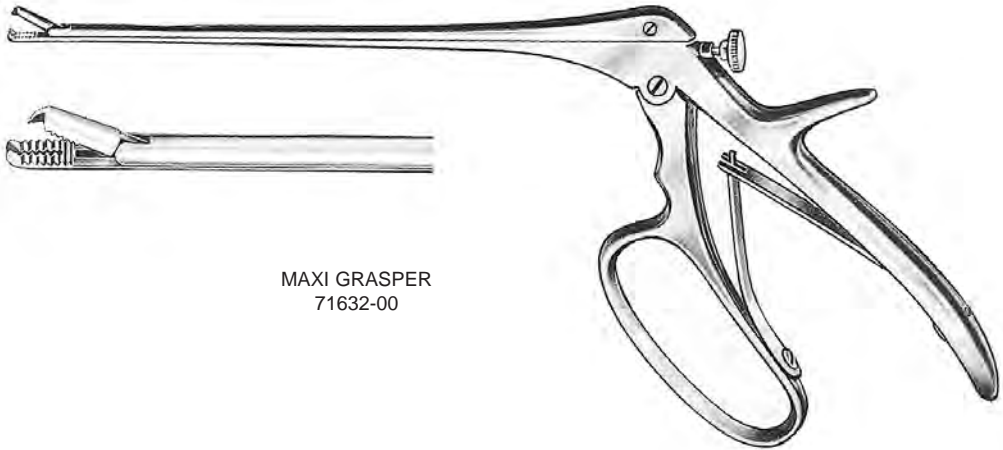

MAXI GRASPER
71632-00

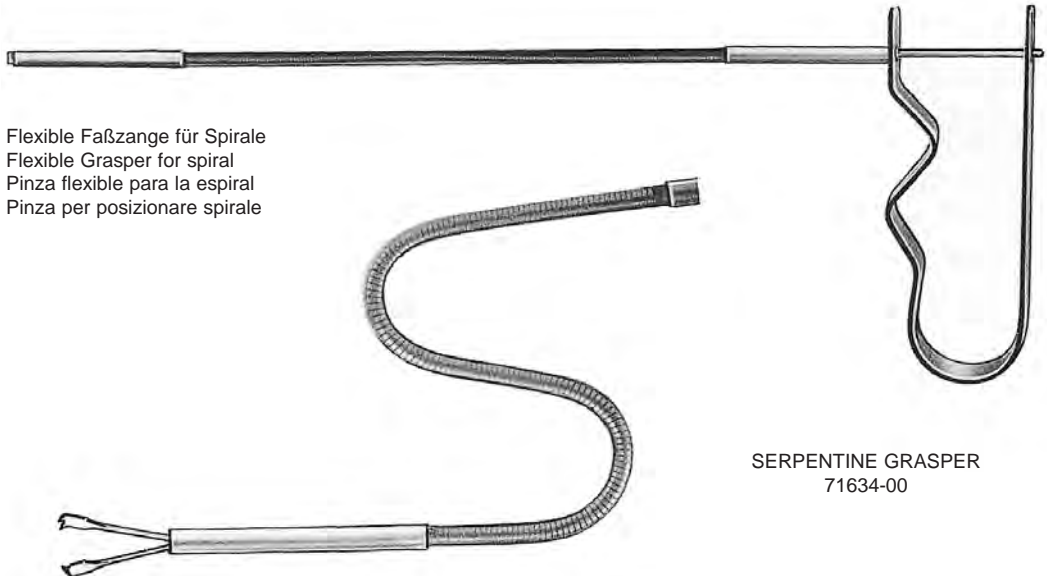

Flexible Faßzange für Spirale
Flexible Grasper for spiral
Pinza flexible para la espiral
Pinza per posizionare spirale

SERPENTINE GRASPER
71634-00



I.U.D.
Extractor Hook
71635-26
26 cm, 10 1/4"

Myomheber, Myommesser, Fistelhäkchen, Meßinstrumente, Uteruslöffel
 Myoma Screw, Myoma Knife, Fistula Hook, Measuring Instruments, Uterine Curettes
 Tirabuzón para fibromas, Bisturi para fibromas, Ganchos para fistulas, Instrumental para medir, Curetas uterinas
 Tiramiomi, Bisturi per fibromi, Uncini per fistole, Strumenti per misure, Curette uterine

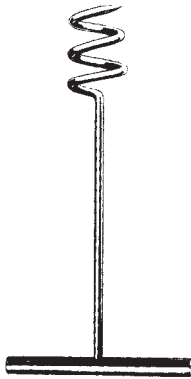

DOYEN
 71641-17
 17 cm, 6 3/4"

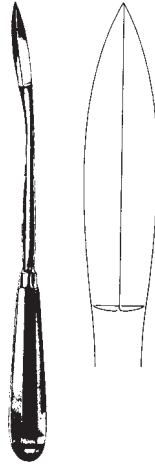

SEGOND
 71643-27
 27 cm, 10 1/2"

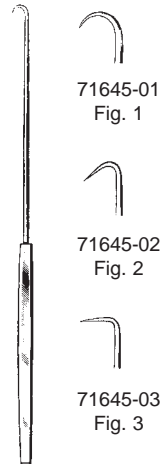

EMMET
 71645-01 - 71645-03
 22 cm, 8 3/4"

71645-01
 Fig. 1

71645-02
 Fig. 2

71645-03
 Fig. 3

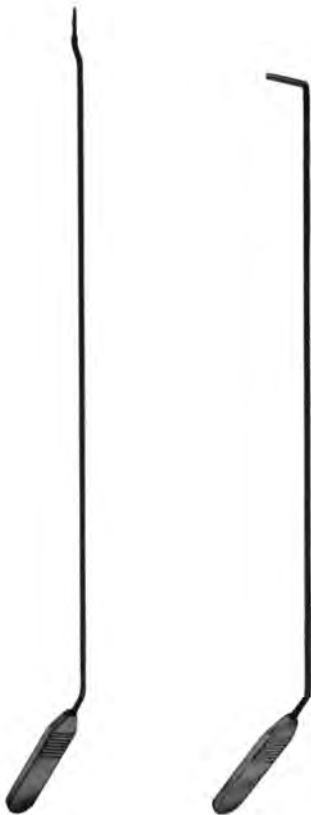

71646-01

71646-02

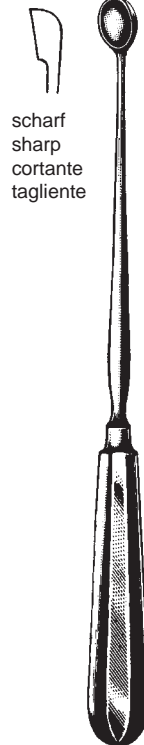

scharf
 sharp
 cortante
 tagliente

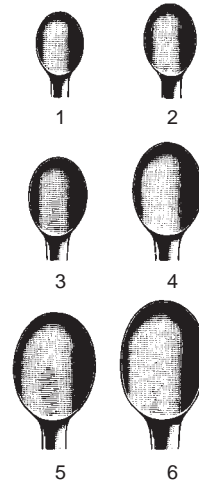

Fig. SIMON
 1 71702-01 6,8 mm
 2 71702-02 8,5 mm
 3 71702-03 10,0 mm
 4 71702-04 11,5 mm
 5 71702-05 13,0 mm
 6 71702-06 14,5 mm
 25 cm, 10"

Uterus-Küretten
Uterine Currettes
Curetas uterinas
Curette uterine



SCHRÖDER
31 cm, 12 1/4"



71703-01
6,8 mm



71703-02
8,5 mm



71703-03
10 mm



71703-04
11,5 mm



71703-05
13 mm



71703-06
14,5 mm

scharf/stumpf
sharp/blunt
cortante/roma
tagliente/smussa



BLAKE
71704-27
27 cm, 10 1/2"

Salpingograph
Salpingograph
Salpingógrafo
Salpingografo

71650-00

Schultze Salpingograph
bestehend aus:

- 71650-01 1 Tubenkatheter
- 71650-02 1 Zwischenstück
- 71650-03 1 Manometer
- 71650-04 1 Kegel, klein
- 71650-05 1 Kegel, mittel
- 71650-06 1 Kegel, groß
- 71650-07 1 Recordspritze mit
Luer-Lock-Ansatz 10cc

Salpingógrafo compuesto de:

- 71650-01 1 cateter de tubo
- 71650-02 1 pieza de conexion
- 71650-03 1 manometro
- 71650-04 1 cono pequeño
- 71650-05 1 cono mediano
- 71650-06 1 cono grande
- 71650-07 1 jeringa con
conexion Luer-Lock 10cc

Salpingografo composto da:

- 71650-01 1 Catetere per tubo
- 71650-02 1 Raccordo
- 71650-03 1 Manometro
- 71650-04 1 Cono, piccolo
- 71650-05 1 Cono, medio
- 71650-06 1 Cono, grande
- 71650-07 1 Siringa record con
Raccordo Luer-Lock 10cc

71660-00

Schultze Salpingograph, jedoch ohne
Manometer

Schultze Salpingograph without
manometer

Schultze Salpingografo sin manometro

Schultze Salpingografo senza
manometro

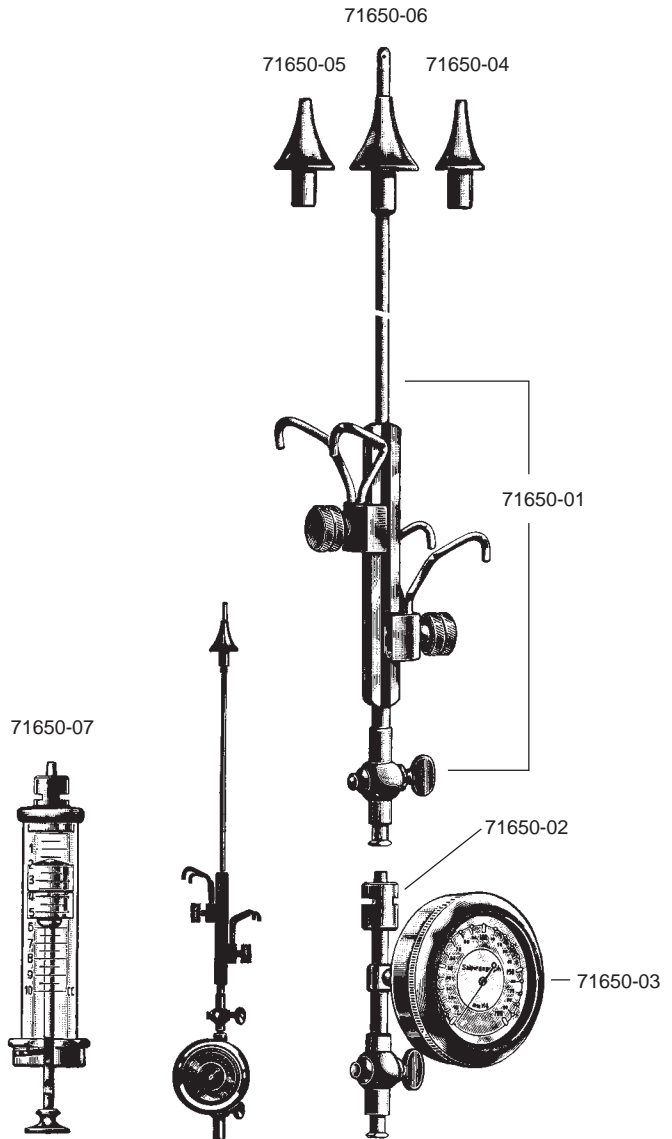

SCHULTZE
71650-00
compl.

im Etui
in case
en estuche
in astuccio

Uterus-Küretten
 Uterine Curettes
 Curetas uterinas
 Curette Uterine

SIMS

 71710-05 - 71717-14
 28 cm, 11"

	scharf sharp cort. tagl.	Fig.	mm	stumpf blunt roma smussa
fest	71710-05	00	5,0	71715-05
rig.	71710-06	0	6,0	71715-06
	71710-07	1	7,5	71715-07
	71710-08	2	8,5	71715-08
	71710-09	3	10,0	71715-09
	71710-11	4	11,5	71715-11
	71710-12	5	13,5	71715-12
	71710-14	6	14,5	71715-14

RECAMIER

 71720-05 - 71727-20
 31 cm, 12 1/4"

	scharf sharp cort. tagl.	Fig.	mm	stumpf blunt roma smussa
fest	71720-05	00	5	71725-05
rig.	71720-06	0	6	71725-06
	71720-07	1	7	71725-07
	71720-08	2	8	71725-08
	71720-09	3	9	71725-09
	71720-11	4	11	71725-11
	71720-12	5	12	71725-12
	71720-14	6	14	71725-14
	71720-15	7	15	71725-15
	71720-16	8	16	71725-16
	71720-19	9	19	71725-19
	71720-20	10	20	71725-20



BUMM

 71730-30 - 71737-40
 28 cm, 11"

	scharf sharp cort. tagl.	Fig.	stumpf blunt roma smussa
fest	71730-30	14	71735-30
rig.	71730-35	15	71735-35
	71730-40	16	71735-40

flexibel	71732-30	14	71737-30
flexible	71732-35	15	71737-35
fless.	71732-40	16	71737-40

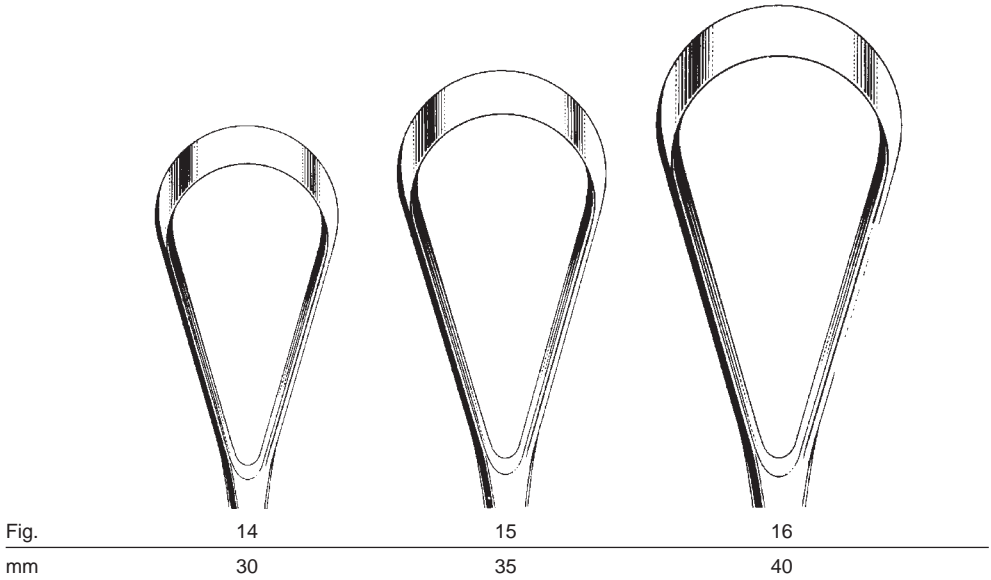
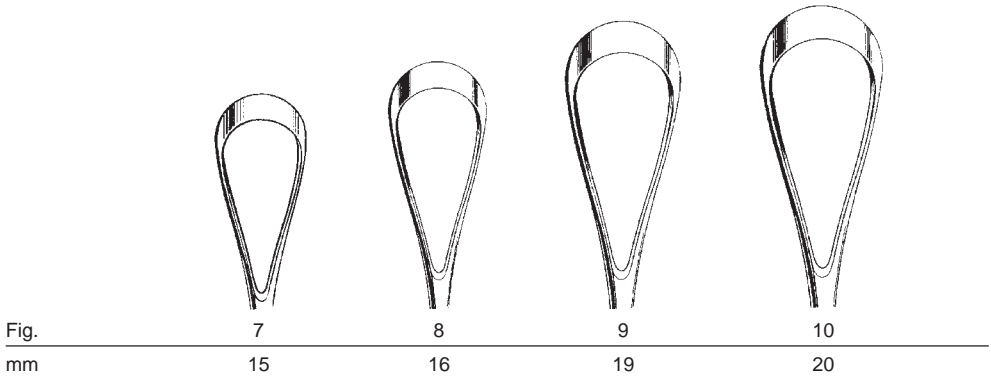
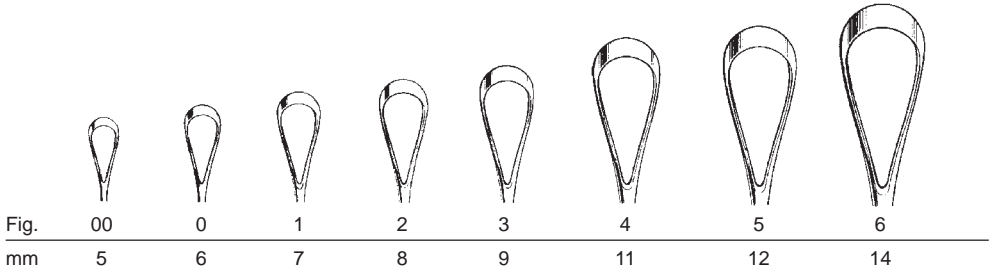
Uterus-Küretten
 Uterine Curettes
 Curetas uterinas
 Curette uterine



SIMS
 RECAMIER
 BUMM
 71710-05 - 71735-28

Uterus-Küretten
 Uterine Curettes
 Curetas uterinas
 Curette uterine



THOMAS
 28 cm, 11"
 stumpf
 blunt
 roma
 smussa

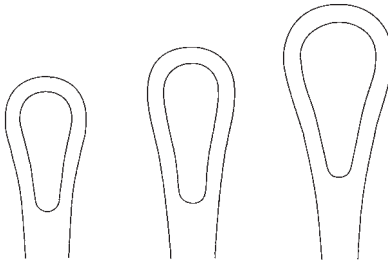

Fig.0
 6 mm
 71736-00

Fig.1
 7 mm
 71736-07

Fig.2
 8 mm
 71736-08

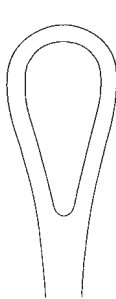

Fig.3
 9 mm
 71736-09



Fig. 4
 10 mm
 71736-10

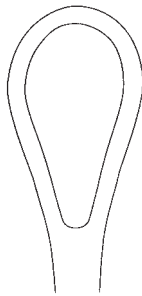

Fig. 5
 11 mm
 71736-11

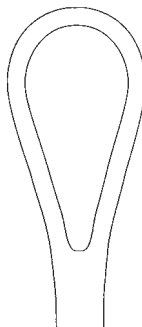
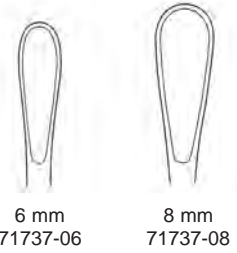

Fig. 6
 12 mm
 71736-12



GOURDET
 28 cm, 11"



6 mm
 71737-06

8 mm
 71737-08



10 mm
 71737-10



12 mm
 71737-12



14 mm
 71737-14

Biopsie- und Absaugküretten, Schlauch-Verbindungsstück
 Specimen and Aspirating Curettes, Hose connecting piece
 Curetas para biopsia y aspiración, Pieza conexión para tubos
 Curette di aspirazione per biopsia, Raccordo di connessione per tubi



71803-03
3 mm Ø

71803-04
4,5 mm Ø

71803-06
6 mm Ø

71803-08
8 mm Ø

71803-10
10 mm Ø

71803-12
12 mm Ø

71803-14
14 mm Ø



71803-15

Amnioskope
Amnioscope
Amnioscopio
Amnioscopio



71810-12 12 x 24 mm Ø 20 cm (8") lang
71810-16 16 x 24 mm Ø 20 cm (8") lang
71810-20 20 x 24 mm Ø 20 cm (8") lang



71810-50
Kaltlichtklammer
Cold Light clamp
Adaptador de iluminacion
Adattore di illuminazione

Geburtszangen
Obstetrical Forceps
Forceps obstétricos
Forcipi

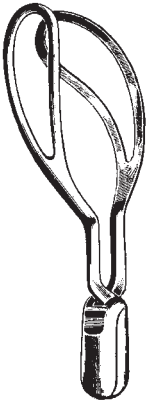

WRIGLEY
73101-23
23 cm, 9"

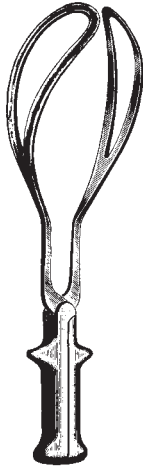

SIMPSON
73102-30
30 cm, 11 3/4"

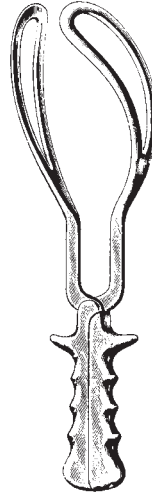

SIMPSON-BRAUN
73105-33 33 cm, 13"
73105-36 36 cm, 14"

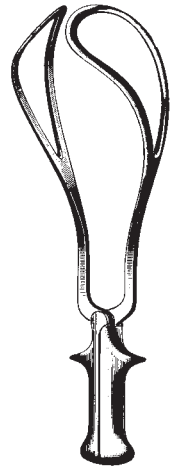

De LEE
73107-30
30 cm, 11 3/4"



De LEE
73108-36 36 cm, 14"
73108-39 39 cm, 15 1/2"

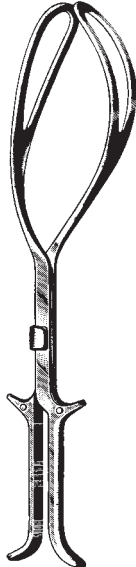

KIELLAND
73110-41
41 cm, 16"



ELLIOT
73115-32 32 cm, 12 3/4"
73115-38 38 cm, 15"

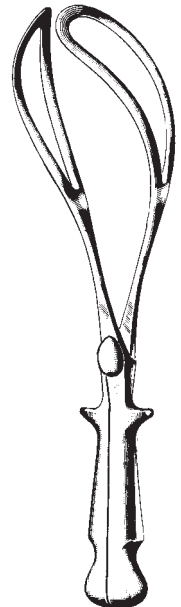

NAEGELE
73119-36 36 cm, 14"
73119-40 40 cm, 15 3/4"

Geburtszangen
 Obstetrical Forceps
 Forceps obstétricos
 Forcipi

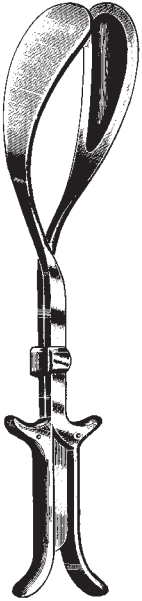

LUIKART
 73125-40
 40 cm, 15 3/4"

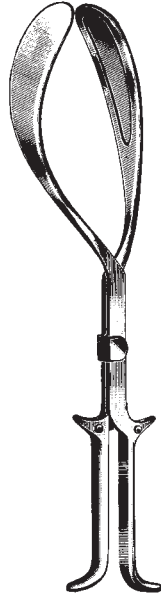

KIELLAND-LUIKART
 73127-40
 40 cm, 15 3/4"

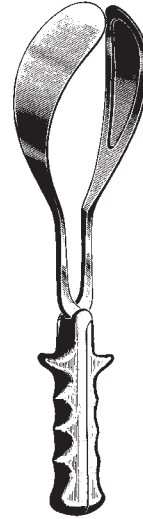

SIMPSON-LUIKART
 73135-36
 36 cm, 14"

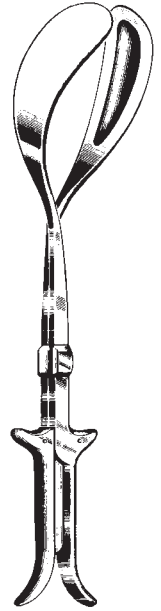

McLEAN-TUCKER-LUIKART
 73139-40
 40 cm, 15 3/4"

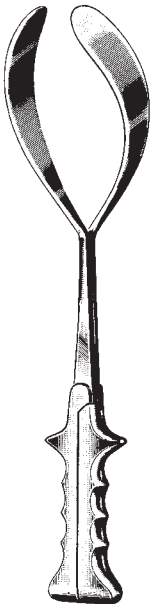

McLEAN-TUCKER
 73141-39
 39 cm, 15 1/2"

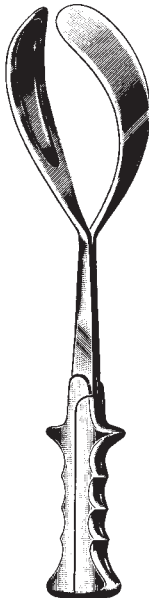

McLEAN-LUIKART
 73143-39
 39 cm, 15 1/2"

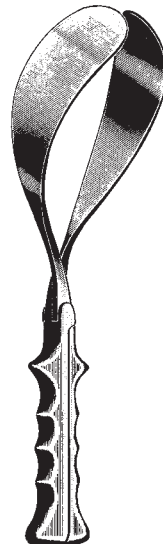

McLEAN
 73145-36
 36 cm, 14"

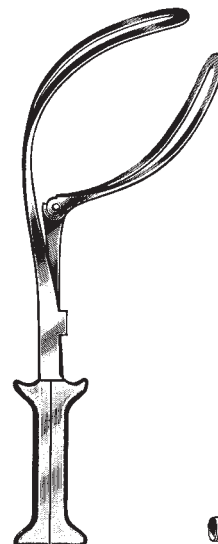

BARTON
 73147-36
 36 cm, 14"

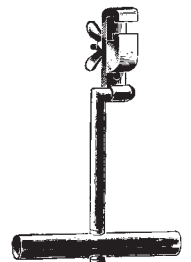

BARTON
 73148-17
 17 cm, 6 3/4"

Geburtszangen, Zughebel
 Obstetrical Forceps, Traction handles
 Forceps obstétricos, Dispositivos de tracción
 Forcipi, Leve per trazione

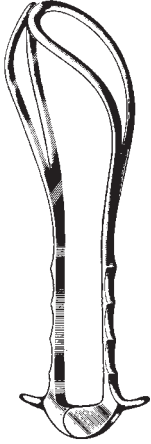

BOERMA
 73151-29
 29 cm, 11 1/2"

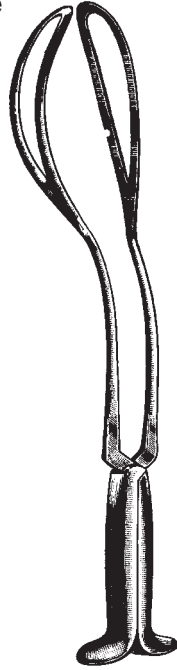

PIPER
 73155-44
 44 cm, 17 1/4"

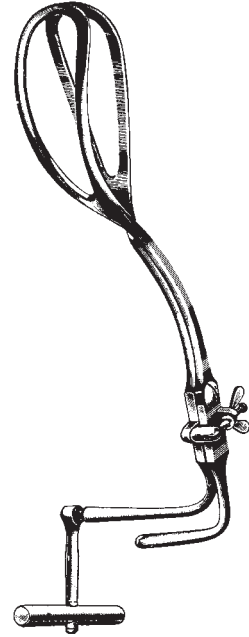

PIPER
 73157-40
 40 cm, 15 3/4"

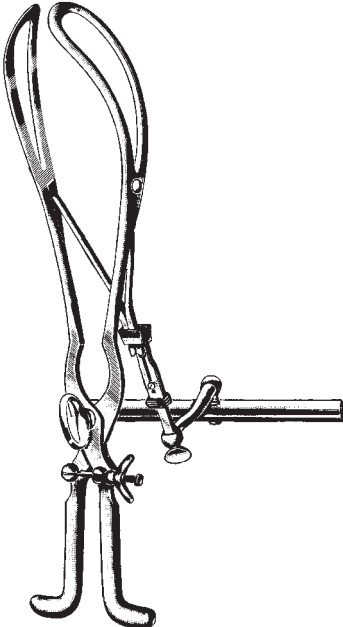

TARNIER
 73162-40
 40 cm, 15 3/4"

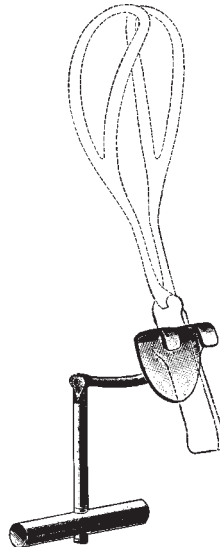

BILL
 73170-00
 21 cm, 8 1/4"

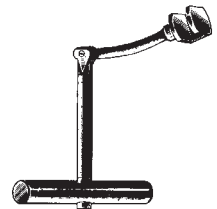

LUIKART-BILL
 73171-21
 21 cm, 8 1/4"

Haken, Kopfschwartzangen, Uterus-Klemmzange, Nabelschnurklemmen, Beckenzirkel
 Scalp flap forceps, Uterine haemostatic forceps, Umbilical cord clamps, Pelvimeters
 Pinzas para cuero cabelludo, Pinzas-clamps uterinas para hemóstasis, Clamp umbilical, Pelvímetros
 Pinza per il cuoio capelluto, Pinza uterina, Pinza ombelicale, Pelvimetri



SMELLIE
 73181-33
 33 cm, 13"

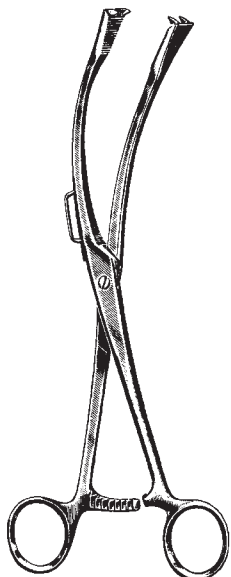

GAUSS
 73183-27
 27 cm, 10 1/2"

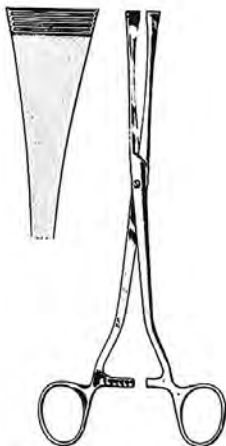

GREEN-ARMYTAGE
 73184-21
 21 cm, 8 1/4"



COLLIN
 73187-09
 9 cm, 3 1/2"

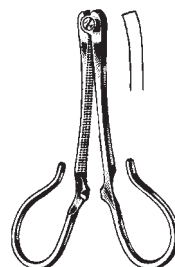

KANE
 73189-09
 8,5 cm, 3 1/4"

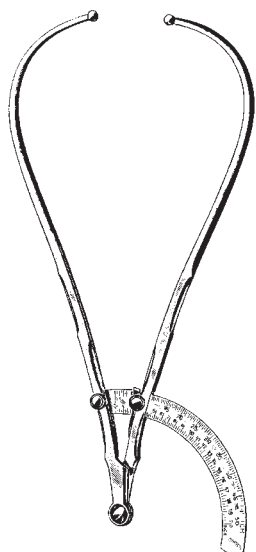

MARTIN
 73191-34
 34 cm, 13 1/2"

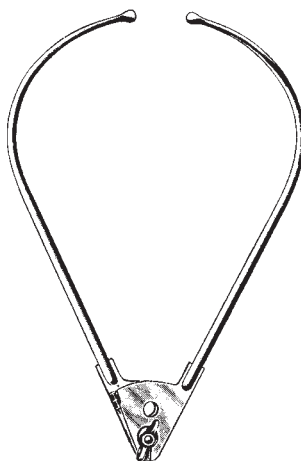

COLLIER
 73193-30
 30 cm, 11 3/4"

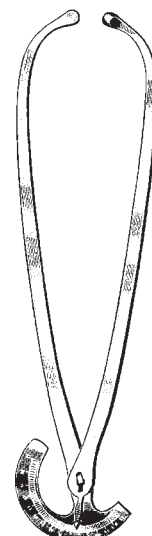

COLLIN
 73195-35
 35 cm, 14"

Abortuszangen, Abortuslöffel
 Ovum Forceps, Abortion Scoops
 Pinzas para aborto, Cucharillas para aborto
 Ostetricia, Curette per aborto



SAENGER
 73242-27 73243-27
 27 cm, 10 1/2"

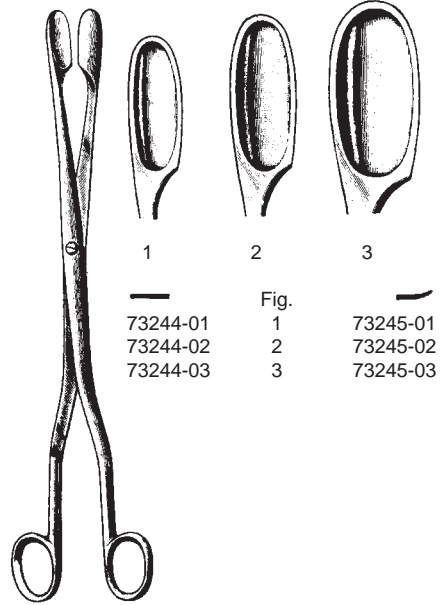

WINTER
 73244-01 - 73245-03
 28 cm, 11"

	Fig.	
73244-01	1	73245-01
73244-02	2	73245-02
73244-03	3	73245-03

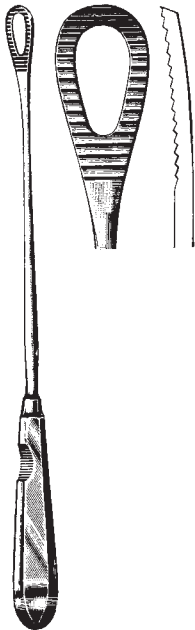

PESTALOZZA
 73252-30
 30 cm, 11 3/4"



CUZZI
 73254-14 - 73254-21
 30 cm, 11 3/4"

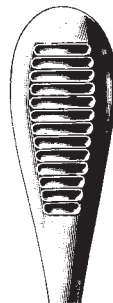

73254-14
 14,5 mm

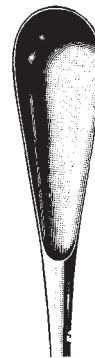

73254-18
 18 mm

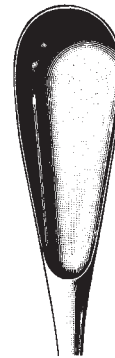

73254-21
 21 mm

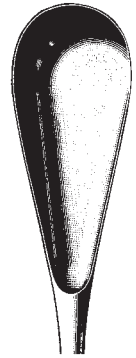

Abortuslöffel, Geburtslöffel, Kranioklast, Basiotrip, Perforatorie, Dekapitationshaken
 Abortion Scoops, Elevating Spoon, Cranioclast, Basiotribe, Perforators, Decapitating hook
 Cucharillas para aborto, Separador obstetrico, Craneoclasto, Basiotribo, Perforacráneos, Gancho para decapitación
 Curette per aborto, Cucchiaio Ostetrico, cranioclasto, Basiotribo, spezzacrani, Uncino per decapitazione



stumpf
blunt
roma
smussa



WALLICH
73256-42
42 cm, 16 1/2"



SELLHEIM
73259-28
28 cm, 11"

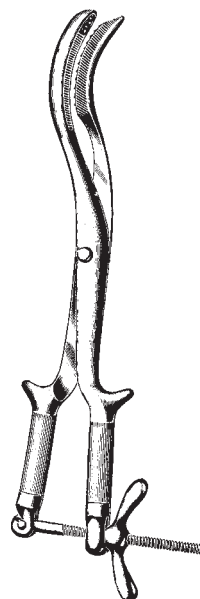

BRAUN
73302-42
42 cm, 16 1/2"



TARNIER
73304-46
46 cm, 18"

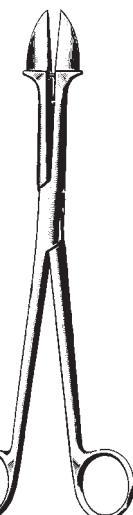

SMELLIE
73306-25
25 cm, 10"



BRAUN
73309-30
30 cm, 11 3/4"

Hauthäkchen, Komedonenquetscher, Lupusküretten, Hautküretten, Haut-Trephinen
 Skin hooks, Comedone extractors, Lupus curettes, Skin curettes, Cutaneous punches
 Ganchos cutáneos, Saca comedones, Curetas para lupus, Curetas cutáneas, Trépanos cutáneos
 Uncini cutanei, Schiaccia comedoni, Curette per lupus, Curette cutanee, Trefine cutanee



KILNER
75103-15
15 cm, 6"



SCHAMBERG
75111-10
10 cm, 4"



UNNA
75113-14
14 cm, 5 1/2"

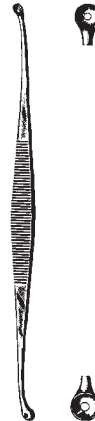

UNNA
75115-14
14 cm, 5 1/2"



WALTON
75118-14
14 cm, 5 1/2"



SAALFELD
75121-10
10 cm, 4"

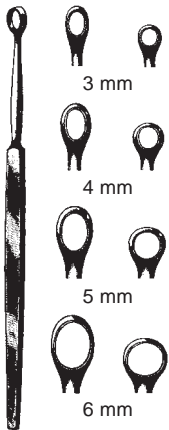

14 cm, 5 1/2"

FOX	FOX
75128-01 1 mm	75129-01 1 mm
75128-02 2 mm	75129-02 2 mm
75128-03 3 mm	75129-03 3 mm
75128-04 4 mm	75129-04 4 mm
75128-05 5 mm	75129-05 5 mm
75128-06 6 mm	75129-06 6 mm

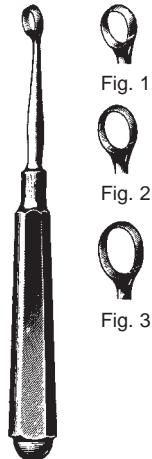

PIFFARD
14,5 cm, 5 3/4"
75130-01 Fig. 1
75130-02 Fig. 2
75130-03 Fig. 3

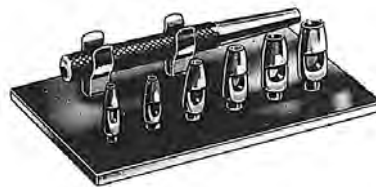

75138-00
Satz komplett mit 6 Aufsätzen
Set complete with 6 tips
Juego con 6 puntas
Serie completa con 6 trefini

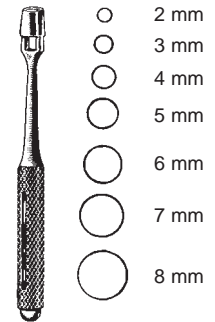

KEYES
10 cm, 4"
75140-02 2 mm
75140-03 3 mm
75140-04 4 mm
75140-05 5 mm
75140-06 6 mm
75140-07 7 mm
75140-08 8 mm

Nagelzangen, -Scheren
Nail Nippers, Scissors
Alicates corta-uñas
Tronchesini forbici per unghie



75301-10

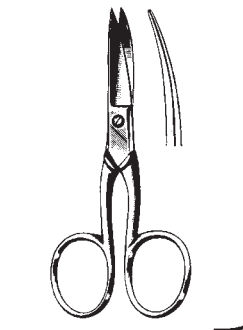

75304-10 10 cm, 4" 75305-10



75331-14
14 cm, 5 1/2"
stainless



TURNBULL
75341-11 11,5 cm, 4 1/2"
75341-13 13,5 cm, 5 1/4"
stainless

Nagelhautzangen, Hautscheren, Nagelfeilen
 Cuticle Nippers, Cuticle Scissors, Nail Files
 Pinzas y Tjeras cuticulares, Limas para uñas
 Tronchesine per unghie e pelle, Limette per le unghie



75373-10
 10,5 cm, 4"

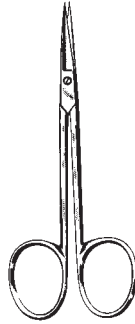

75378-10
 10 cm, 4"

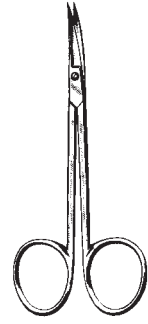

75379-10
 10 cm, 4"



75382-16



75386-10 10 cm, 4"
 75386-12 12 cm, 4 3/4"

Bürstenspender, Handwaschbürsten
Brush Dispensor, Nail brushes
Dispensador de cepillos, Cepillo para uñas
Distributore di spazzole, Spazzole per unghie

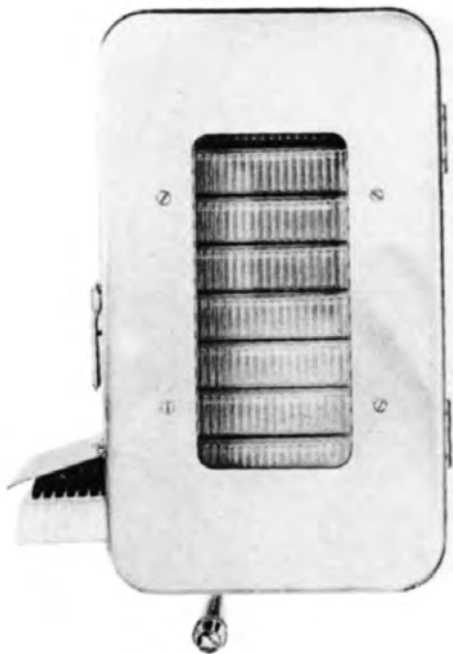

75396-01
Bürstenspender für 10 Bürsten
Brush dispensor for 10 brushes
Distribuidor de cepillos para 10 cepillos
Distributore per spazzolini da 10

75396-02
Bürstenspender für 20 Bürsten
Brush dispensor for 20 brushes
Distribuidor de cepillos para 20 cepillos
Distributore per spazzolini da 20

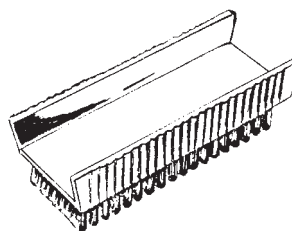

75397-00

Pack. à 10 St.
Box of 10 pcs
caja de 10 pzas.
confezione da 10 pezzi

Hygiene
Hygiene
Higiene
Igiene



PROBE AND PACKER
75450-00
14,5 cm, 5 3/4"



SPATULA AND PACKER
75440-00
14,5 cm, 5 3/4"



mit Loch, with hole,
con agujero, con foro

75430-12 = 1,5 mm + 2 mm
75430-13 = 1,5 mm + 2,5 mm
14,5 cm, 5 3/4"



14,5 cm, 5 3/4"
ohne Loch, without hole,
sin agujero, senza foro

75400-01 = 1 mm
75400-02 = 1,5 mm
75400-03 = 2 mm
75400-04 = 2,5 mm

mit Loch, with hole,
con agujero, con foro

75410-01 = 1 mm
75410-02 = 1,5 mm
75410-03 = 2 mm
75410-04 = 2,5 mm

Hygiene
Hygiene
Higiene
Igiene

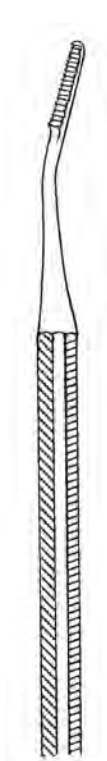

75420-15
15 cm, 6"

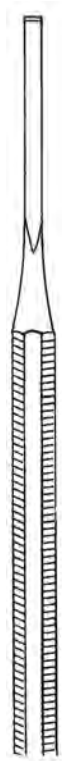

75430-01
12,5 cm, 5"

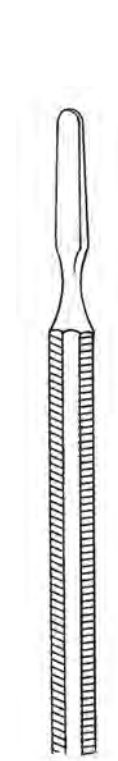

75440-11
11,5 cm, 4 1/2"

Nagelzangen
Nail Nippers
Alicates corta-uñas
Tronchesini per unghie

stainless steel

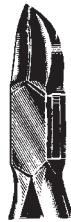

75450-13
concave

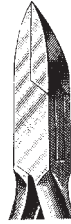

75460-13
gerade
straight
recto
retta



75450-13 - 75460-13
13 cm, 5 1/8"

stainless steel



75470-11
10 cm
4"



75475-11
11,5 cm
4 1/2"

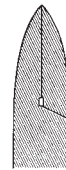

75480-13
12,5 cm
5"

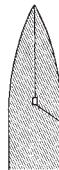

fine
75485-13
12,5 cm
5"

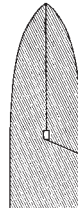

75490-15
15 cm
6"

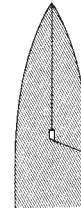

fine
75500-15
15 cm
6"

Nagelzangen
 Nail Nippers
 Alicates corta-uñas
 Tronchesini per unghie

stainless steel

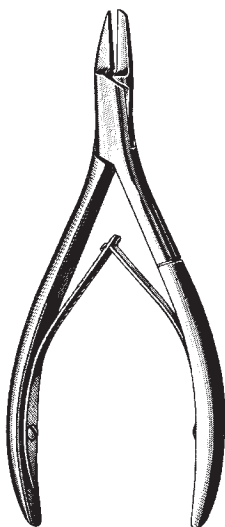

ANVIL
 75550-13
 13 cm, 5 1/8"

stainless steel

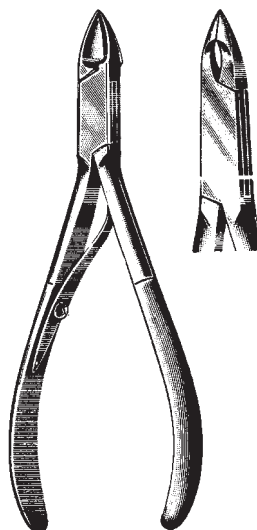

75600-10
 10 cm, 4"

stainless steel



75618-15
 15,2 cm, 6"

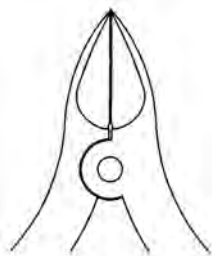

gerade
 straight

stainless steel

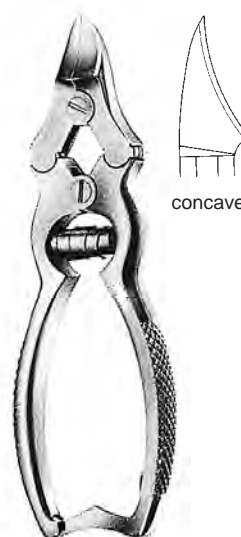

75620-15
 15,5 cm, 6"

concave

Nagelzangen, Nagelscheren
Nail Nippers, Nail scissors
Alicates corta-uñas, Tijeras para uñas
Tronchesini per unghie, Forbici per unghie



75630-12
12 cm, 4³/₄"



75640-15
15 cm, 6"

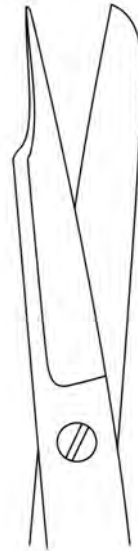

Nagelspaltscheren
Nail splitting scissors
Tijeras para hender uñas
Forbici per staccare unghie

Nadel-Sterilisierkästen, Kappenzangen
 Needle Sterilizing cases, Sterilizing Forceps
 Estuches para esterilizar agujas, Combinacion tapa-pinza
 Scatole per sterilizzare aghi, Pinza coperchio

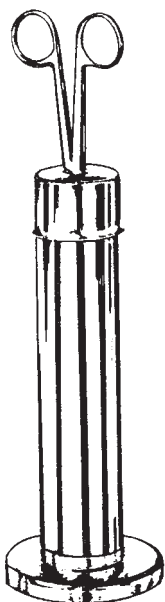

89111-25 25 cm, 10"
 89111-32 32 cm, 12³/₄"



89112-65
 65 x 15 mm



89113-65



89114-00
 150 x 95 x 13 mm



89115-50 50 x 25 x 4,5 mm
 89115-65 65 x 42 x 8,0 mm
 89115-75 75 x 25 x 4,5 mm



89116-50 50 x 25 x 4,5 mm
 89116-65 65 x 42 x 8,0 mm
 89116-75 75 x 25 x 4,5 mm

Sterilisierkästen
Sterilizing Cases
Cajas para esterilización
Scatole per sterilizzazione



89117-20 200 x 100 x 25 mm
89117-23 230 x 130 x 25 mm
89117-27 275 x 230 x 25 mm

89118-20
89118-23
89118-27

Sterilisier-Behälter mit Silikonmatte
Micro instrument tray with silicone mat
Caja para instrumental micro-quirurgico con alfombrilla de silicona
Scatola per sterilizzazione con stuoia in silicone

Silikonmatte
Silicone mat
Alfombrilla de silicona
Stuoia in silicone

Instrumentenkästen
Instrument Boxes
Cajas para instrumentos
Scatole per strumenti



Abmessungen in mm	ohne Knopfdeckel
Sizes in mm	lid without knob
tamaños en mm	tapa sin botón
misura in mm	coperchio senza bottone

l x b x h mm	
165x 85x35	89122-16
200x100x50	89122-21
260x150x50	89122-26
310x200x50	89122-30

Sterilisierkästen
Sterilizing Cases
Cajas para esterilización
Scatole per sterilizzazione



Abmessungen in mm (l x b x h)
Sizes in mm (l x b x h)
tamaños en mm (l x f x a)
misura in mm (l x l x a)

230 x 130 x 50
260 x 150 x 50
275 x 235 x 50
300 x 200 x 50
325 x 275 x 50
420 x 175 x 50

230 x 130 x 75
260 x 150 x 75
300 x 200 x 75
325 x 275 x 75
420 x 175 x 75

Behälter
Containers
Recipientes
Recipienti

89124-23
89124-26
89124-27
89124-30
89124-32
89124-42

89125-23
89125-26
89125-30
89125-32
89125-42

Satz Spezialfilter (5 Paar)
Set of spezial filters (5 pairs)
Juego de filtros especiales (5 pares)
Set die 5 paia di filtri speciali

89126-23
89126-26
89126-27
89126-30
89126-32
89126-42

89127-23
89127-26
89127-30
89127-32
89127-42

Schalen
Trays
Bandejas
Bacinelle

18/10
Stainless Steel
Acero inoxidable
Acciajo inossidabile

matt
satin finish
pulidas mate
opaco



Abmessungen in mm sizes in mm Tamaños en mm misura in mm Ø x h	Inhalt capacity capacidad capacità l	
40x19	0,05	89127-04
61x30	0,07	89127-06
80x40	0,14	89127-08
116x50	0,35	89127-11
128x55	0,45	89127-12
147x65	0,70	89127-14
167x75	1,10	89127-16
187x85	1,60	89127-18



Abmessungen in mm sizes in mm Tamaños en mm misura in mm Ø x h	Inhalt capacity capacidad capacità l	
110x28	0,15	89129-11



	mm x mm	l
89133-16	165 x 60	0,75
89133-17	175 x 70	1,00
89133-22	220 x 80	2,00
89133-24	240 x 110	3,00
89133-25	255 x 115	4,00
89133-31	310 x 120	6,00
89133-34	345 x 125	8,50
89133-38	380 x 130	11,00



89139-17	170 x 100 x 35 mm	0,50 l
89139-25	250 x 140 x 40 mm	1,25 l
89139-27	275 x 150 x 45 mm	2,25 l

Meßbecher, Dose, Standgefäß, Mehrzweckschalen
 Graduated Measures, Box, Jars, Universal Trays
 Copas graduadas, Recipientes, Tarros, Bandejas para instrumentos
 Bicchieri graduati, Recipienti, Recipienti cilindrici, Bacinelle per strumenti

18/10
 Stainless Steel
 Acero inoxidable
 Acciaio inossidabile

matt
 satin finish
 pulidas mate
 opaco



l	
0,25	89140-02
0,5	89140-05
1,0	89140-10
2,0	89140-20



89141-10
 100 x 20 mm



	mmxmm
89142-01	30x 90
89142-02	50x100
89142-03	50x130
89142-04	50x175
89142-05	75x100
89142-06	75x130
89142-07	75x175



89147-21 - 89147-42

	l x b x h
89147-21	210x160x10 mm
89147-24	240x180x10 mm
89147-30	310x150x10 mm
89147-31	310x210x10 mm
89147-35	350x240x10 mm
89147-40	400x270x20 mm
89147-42	420x280x10 mm



89145-23 - 89145-40

	l x b x h
89145-23	230x155x30 mm
89145-30	300x175x30 mm
89145-31	300x175x40 mm
89145-35	350x240x36 mm

Medizinlöffel, -becher, Tablettenschale, Sputumbecher, Stechbecken, Plazentabecken
 Medicine Spoon and Cups, Trays for tablets, Sputum Cup, Bed Pan, Placenta Pan
 Cuchara graduada, Vasos graduados, Platos para tabletas, Escupidera, Silleta, Cubeta para placenta
 Cucchiaino per medicinali, bicchieri per medicinali, Bacinelle per compresse, Sputacchiera, Padella, bacinella per placenta



89146-20 20 cc
110 x 20 mm



89147-10 100 cc
89147-25 250 cc



89148-25 25 cc
89148-50 50 cc



89148-31
ø 310 mm



89148-32



89148-35
350 x 290 x 90 mm



89149-13 110 x 13 mm
89149-20 95 x 20 mm



89150-30
90 x 80 mm

Verbandstofftrommel, Sterilisiersiebschalen
 Sterilizing Drums, Sterilization Trays
 Tambores p. esterilización, Cestas de esterilización
 Tamburi p. sterilizzazione, Cestelli per sterilizzazione



SCHIMMELBUSCH

	Ø
	mmxmm
89152-08	125x 80
89152-10	125x100
89152-12	125x125
89155-08	150x 80
89155-10	150x100
89155-13	150x130
89155-15	150x150
89155-19	150x190
89159-14	190x145
89159-16	190x165
89159-19	190x190
89159-24	190x240
89164-14	240x145
89164-16	240x165
89164-19	240x190
89164-24	240x240
89164-29	240x290
89164-34	240x340
89164-39	240x390
89169-14	290x145
89169-16	290x165
89169-19	290x190
89169-24	290x240
89169-29	290x290
89169-34	290x340
89169-39	290x390
89174-14	340x145
89174-16	340x165
89174-19	340x190
89174-24	340x240
89174-29	340x290
89174-34	340x340
89174-39	340x390
89179-14	390x145
89179-16	390x165
89179-19	390x190
89179-24	390x240
89179-29	390x290
89179-34	390x340
89179-39	390x390
89179-49	390x490
89179-59	390x590

18/10
 Stainless Steel
 Acero inoxidable
 Acciaio inossidabile
 Acciaio inossidabile

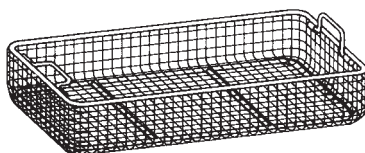

R390.03	255x245x 30 mm
R390.05	255x245x 50 mm
R390.07	255x245x 70 mm
R390.10	255x245x100 mm
R190.03	485x255x 30 mm
R190.05	485x255x 50 mm
R190.07	485x255x 70 mm
R190.10	485x255x100 mm
R191.03	540x255x 30 mm
R191.05	540x255x 50 mm
R191.07	540x255x 70 mm
R191.10	540x255x100 mm

Siebschalen, Endoskopiekorb
 Trays
 Bandejas
 Cestelli

Aus perforiertem Blech
 From Perforated Sheet Metal
 De chapa de acero perforada
 In acciaio perforato

18/10
 Stainless Steel
 Acero inoxidable
 Acciajo inossidabile



	cmxcmxcm
89250-10	24x24x 5
89250-20	24x24x 8
89250-30	24x24x10
89250-40	48x26x 5
89250-50	52x26x 8
89250-60	52x26x10

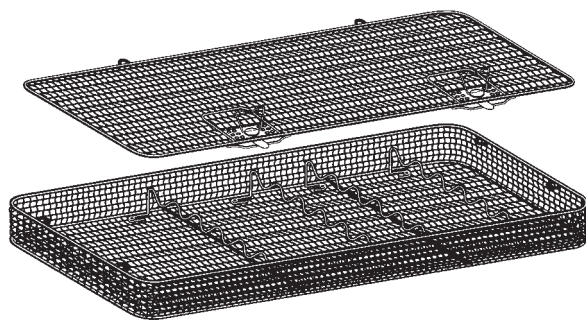

für Lichtleiterkabel
 for cold light cables
 para cables de luz fría
 per cavi a fibre/ottiche
 89255-60 420x250x60 mm

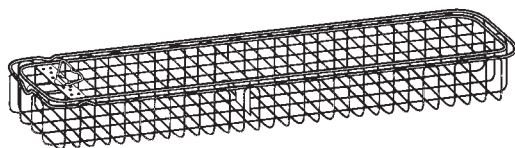

für 1 Endoskop, for 1 endoscope,
 para 1 endoscopio, per 1 endoscopio
 89256-29 290x80x52 mm
 89256-46 460x80x52 mm
 89256-67 670x80x52 mm

für 2 Endoskope, for 2 endoscopes,
 para 2 endoscopios, per 2 endoscopi rigidi
 89257-46 460x80x52 mm

Schlauchklemmen, Messgerät, Sterilisierklammern
 Tubing Clamp, Decimal spring caliper, Safety pins
 Pinzas para tubos, calibrador decimal, Cadres de esterilizacion
 Morsetti serratubi, compasso, pinze per sterilizzazione

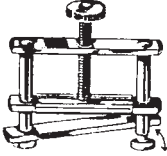

HOFFMANN
 89260-13 13 mm
 89260-17 17 mm
 89260-20 20 mm
 89260-25 25 mm
 89260-30 30 mm
 89260-40 40 mm

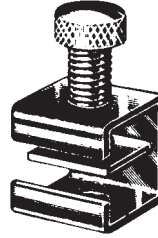

SIMPLEX
 89265-12

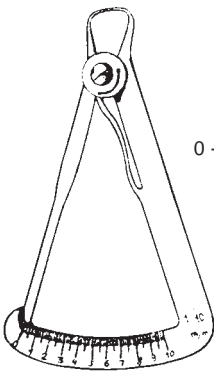

IWANSON
 89270-15

0 - 10 mm



BUNT
 29150-12
 12 cm, 4^{3/4}"

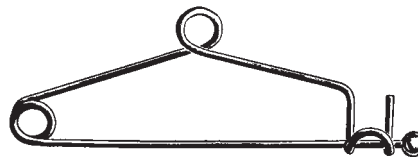

MAYO
 29152-14
 14 cm, 5^{1/2}"

Reinigungspistole
Water Jet Pistol
Pistola-lavatora
Pistola lavatrice



89500-00
komplett mit 9 Aufsätzen
complete with 9 tips
con 9 toberas
completa con 9 raccordi

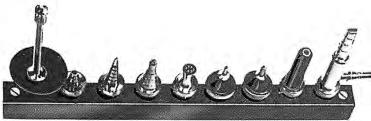

89500-01
Reinigungsaufsatz für Flaschen
Cleansing Tip for bottles
Tobera para botellas
Raccordo di lavaggio per bottiglie



89500-02
Reinigungsaufsatz für Recordspritzen-Konen
Cleansing Tip for Cones of Record Syringes
Tobera para conos de jeringas Record
Raccordo per coni di siringhe Record



89500-03
Reinigungsaufsatz für Katheter
Cleansing Tip for Catheters
Tobera para catéteres
Raccordo di lavaggio per cateteri



89500-04
Reinigungsaufsatz für Drainageschläuche
Cleansing Tip for Drainage Tubings
Tobera para tubos de drenaje
Raccordo di lavaggio per tubi di drenaggio



89500-05
Reinigungsaufsatz für Hohlgefäße (Brause)
Cleansing Tip for Receptacles (Shower)
Tobera para recipientes (ducha)
Raccordo di lavaggio per recipienti (doccia)

89500-12
Pistole allein
Pistol only
Pistola sola
Pistola sola

89500-06
Reinigungsaufsatz für Kanülen mit Recordkonus
Cleansing Tip for hypodermic needles with Record Cone
Tobera para agujas de inyección con cono Record
Raccordo di lavaggio per aghi ipodermici con cono Record



89500-07
Reinigungsaufsatz für Kanülen mit Luerkonus
Cleansing Tip for hypodermic needles with Luer Cone
Tobera para agujas de inyección con cono Luer
Raccordo di lavaggio per aghi ipodermici con cono Luer



89500-08
Reinigungsaufsatz für Meß- und Vollpipetten
Cleansing Tip for Meas. and Volumetric Pipettes
Tobera para pipetas de medida y volumétricas
Raccordo di lavaggio per pipette comuni e graduate



89500-09
Reinigungsaufsatz für feine Pipetten
Cleansing Tip for fine pipettes
Tobera para pipetas finas
Raccordo di lavaggio per pipette fine

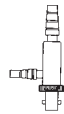

89500-10
Reinigungsaufsatz 31 cm (12 1/4") gerade
Cleansing Tip 31 cm (12 1/4") straight
Tobera 31 cm (12 1/4") recta
Raccordo 31 cm (12 1/4") rette



89500-11
Reinigungsaufsatz 30 cm (11 3/4") aufgebogen
Cleansing Tip 30 cm (11 3/4") curved
Tobera 30 cm (11 3/4") curva
Raccordo di lavaggio 30 cm (11 3/4") curvo

89501-03
Überwurfmutter zum Anschluß an Gewindehähne
Couplings for connection to water tap
Tuercas-hembras para conexión al grifo de agua
Dadi premistoppa per connessione ai rubinetti filettati

Hochfrequenz-Chirurgie
 High Frequency Surgery
 Electrocirugía
 Electrochirurgia

Mindestbestellmenge 10
 Minimum order quantity 10
 Cantidad minima 10
 Minimo di quantitativo 10



91010-01
 Fig. 1



91010-02
 Fig. 2 45°



91010-03
 Fig. 3 120°



91010-11
 Fig. 11
 Ø 3 mm



91010-12
 Fig. 12
 Ø 5 mm



91010-13
 Fig. 13
 Ø 8 mm



91010-14
 Fig. 14



91010-15
 Fig. 15 45°
 7,0x1,5 mm



91010-16
 Fig. 16 45°
 7 mm



91010-17
 Fig. 17
 6,0x1,3 mm



91010-18
 Fig. 18 30°
 7,0x1,7 mm



91010-21
 Fig. 21
 7,0x1,7 mm



91010-31
 Fig. 31 45°
 Ø 0,6 mm



91010-33
 Fig. 33 45°
 Ø 1,7 mm



91010-34
 Fig. 34 45°
 Ø 3,0 mm



91010-35
 Fig. 35



91010-36
 Fig. 36 90°

Schaft
 shaft
 vástago
 asta
 Ø 2,4 mm

Mindestbestellmenge 10
 Minimum order quantity 10
 Cantidad minima 10
 Minimo di quantitativo 10

Hochfrequenz-Chirurgie
 High Frequency Surgery
 Electrocirugia
 Elettrochirurgia



91011-51
 Fig. 51 45°
 Ø 3 mm



91011-52
 Fig. 52 45°
 7,0x1,7 mm



91011-53
 Fig. 53 45°



91011-54
 Fig. 54



91011-55
 Fig. 55



91011-56
 Fig. 56 45°
 Ø 5 mm



91011-61
 Fig. 61 45°



91011-62
 Fig. 62 90°

Schaft
 shaft
 vástago
 asta
 Ø 2,4 mm

Serie STANDARD



91020-01



91020-02

Schaft
 shaft
 vástago
 asta
 Ø 4 mm



91020-03



91020-04



Ø mm
 5 91022-05
 10 91022-10
 20 91022-20



Ø mm
 10 91024-10
 15 91024-15
 20 91024-20



Ø mm
 2 91030-02
 4 91030-04
 6 91030-06

Schaft
 shaft
 vástago
 asta
 Ø 4 mm

Bipolare Koagulation
 Bipolar Coagulation
 Coagulación bipolar
 Coagulazione bipolare



91102-11
 11 cm, 4 $\frac{3}{8}$ "

91104-11
 11 cm, 4 $\frac{3}{8}$ "

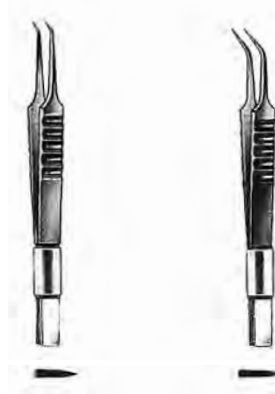

91109-11
 11 cm, 4 $\frac{3}{8}$ "
 45°

91113-11
 11 cm, 4 $\frac{3}{8}$ "
 45°



91115-11
 11 cm, 4 $\frac{3}{8}$ "
 45°



91122-16
 16,5 cm, 6 $\frac{1}{2}$ "

91123-16
 16,5 cm, 6 $\frac{1}{2}$ "



91124-16
 16,5 cm, 6 $\frac{1}{2}$ "
 1 mm



91125-16
 16,5 cm, 6 $\frac{1}{2}$ "

91127-16
 16,5 cm, 6 $\frac{1}{2}$ "
 1 mm

Bipolare Koagulation
Bipolar Coagulation
Coagulación bipolar
Coagulazione bipolare



91142-16
16,5 cm, 6 1/2"



91144-16
16,5 cm, 6 1/2"



91146-16
16,5 cm, 6 1/2"
1 mm



91152-19
19,5 cm, 7 3/4"



91154-19
19,5 cm, 7 3/4"
1 mm



91157-19
19,5 cm, 7 3/4"
1 mm



91159-19
19,5 cm, 7 3/4"
2 mm

Bipolare Koagulation
 Bipolar Coagulation
 Coagulación bipolar
 Coagulazione bipolare



91162-19
 19,5 cm, 7 3/4"



91164-19
 19,5 cm, 7 3/4"
 1 mm



91166-19
 19,5 cm, 7 3/4"
 2 mm



91167-19
 19,5 cm, 7 3/4"
 1 mm



91169-19
 19,5 cm, 7 3/4"
 1 mm



91172-03 - 91172-12
 22,5 cm, 8,9"



91172-03
 0,3 mm



91172-07
 0,7 mm



91172-12
 1,2 mm

Bipolare Koagulation
 Bipolar Coagulation
 Coagulación bipolar
 Coagulazione bipolare

Verbindungskabel
 Connection Cords
 Cables de conexión
 Cavi da connessione



		ERBE SELECT	AESCULAP	USA Mod.	MARTIN
3 m	118"	91190-30	91191-30	91192-30	91193-30
5 m	197"	91190-50		91192-50	91193-50

für Elektro-Chirurgie-Einheiten
 for Electrosurgery Equipment
 para Electrobisturías
 per Elettrobisturi

Instrumentenöl
Instrument oil
Oleo para instrumentos
Olio per strumenti

INSTRU CARE ist ein Instrumentenpflegeöl auf der Basis von hochreinen medizinischen Weißölen zum Erhalt der Funktionsfähigkeit und Werterhaltung von chirurgischen Instrumenten. Die Anwendung erfolgt nach der Reinigung bzw. vor dem Sterilisationsvorgang.

INSTRU CARE is an instrument oil for care and protection of surgical instruments and guarantees the function and protects the value of instruments. It will be used after cleansing and before sterilization process.

INSTRU CARE olio para instrumentos

INSTRU CARE è un olio estremamente puro per la lubrificazione e la pulizia dello strumentario chirurgico. Privo di silicone, appropriato per la sterilizzazione a vapore e ad aria calda. Fisiologicamente inerte con utilizzo prima della sterilizzazione.

Kunststoff-Flasche / plastic bottle / bottiglia / botella
100ml 98000-01

Sprühdose / aerosol / spray / spray
400ml 98000-02





THE INTERNATIONAL CERTIFICATION NETWORK
CERTIFICATE

IQNet and
DQS GmbH Deutsche Gesellschaft zur Zertifizierung von Managementsystemen
hereby certifies that the company

REDA Instrumente GmbH

Gänsäcker 34
D-78532 Tuttlingen

for the scope

Development, manufacturing and distribution of
surgical instruments and medical Products,
endoscopic instruments and accessories

has implemented and maintains a

Quality Management System.

An audit, documented in a report, has verified that
this quality management system fulfills the requirements
of the following standard:

DIN EN ISO 13485 : 2003
November 2003 edition

This certificate is valid until 2011-06-22

Frankfurt am Main 2006-06-23

Registration Number: DE-070894 MP23



Dr. Fabio Roversi
President of IQNet

Ass. iur. M. Drechsel
Managing Directors of DQS GmbH

S. Heinloth
Managing Directors of DQS GmbH



- IQNet Partners*:**
- AENOR Spain AFAQ AFNOR France AIB-Vinçotte International Belgium ANCE Mexico APCER Portugal CISQ Italy CQC China
 - CQM China CQS Czech Republic Cro Cert Croatia DQS Germany DS Denmark ELOT Greece FCAV Brazil
 - FONDONORMA Venezuela HKQAA China ICONTEC Colombia IMNC Mexico IRAM Argentina IQA Japan KPF Korea
 - MSZT Hungary Nemko AS Norway NSAI Ireland PCBC Poland PSB Certification Singapore QMI Canada Quality Austria Austria
 - RR Russia SAI Global Australia Inspecta Certification Finland SII Israel SIQ Slovenia SQS Switzerland SRAC Romania
 - TEST St Petersburg Russia YUQS Serbia and Montenegro

IQNet is represented in the USA by: AFAQ AFNOR, AIB-Vinçotte International, CISQ, DQS, NSAI, QMI and SAI Global

* The list of IQNet partners is valid at the time of issue of this certificate. Updated information is available under www.iqnet-certification.com



C E R T I F I C A T E

DQS GmbH

Deutsche Gesellschaft zur Zertifizierung von Managementsystemen

hereby certifies that the company

REDA Instrumente GmbH

Gänsäcker 34
D-78532 Tuttlingen

for the scope

Development, manufacturing and distribution of
surgical instruments and medical Products,
endoscopic instruments and accessories

has implemented and maintains a

Quality Management System.

An audit, documented in a report, has verified that this
quality management system fulfills the requirements
of the following standard:

DIN EN ISO 13485

November 2003 edition

This certificate is valid until 2011-06-22

Certificate Registration No. 070894 MP23

Frankfurt am Main 2006-06-23

Ass. iur. M. Drechsel

MANAGING DIRECTORS

Dipl.-Ing. S. Heiniöth



D-60433 Frankfurt am Main, August-Schanz-Straße 21



Akkreditiert durch
Zentralstelle der Länder
für Gesundheitsschutz
bei Arzneimitteln
und Medizinprodukten
ZLG-ZQ-987.99.07-46



C E R T I F I C A T E

DQS GmbH

Deutsche Gesellschaft zur Zertifizierung von Managementsystemen

hereby certifies that the company

REDA Instrumente GmbH

Gänsäcker 34
78532 Tuttlingen
Germany

has implemented and maintains a

Quality Management System.

An audit, documented in a report, performed by DQS
has verified that this quality management system
fulfills the requirements of

Annex II of Directive 93/42/EEC

with respect to the following medical devices:

Surgical instruments and Implants according to annex

As set out in section 5, Annex II, of the said directive,
the manufacture of these devices is subject to surveillance.

This certificate is valid until 2010-04-27

Certificate Registration No. 070894 MR2

Frankfurt am Main 2005-04-28



Ass. iur. M. Drechsel



Dipl.-Ing. S. Heinioth

MANAGING DIRECTORS

D-60433 Frankfurt am Main, August-Schanz-Straße 21

EC code number of DQS as notified body: 0297



**Annex to Certificate Registration No.: 070894 MR2
issued 2005-04-28**

REDA Instrumente GmbH

Gänsäcker 34
78532 Tuttlingen
Germany

Produktgruppen	Produkte	UMDNS
Traumatological Implants	bone plates bone screws bone wires bone staples bone nails bone pins bone bolts	13-050 16-101 16-104 16-103 16-078 16-085 16-077
Instrumente for HF-surgery	Monopolar and Bipolar HF-Electrode HF-Adapters Electrode Holders Electrodes active, foot controlled	15-579 11-494 11-497 16-206
Orthopedical Implants	Prostheses joint, shoulder Prostheses joint, hip Prostheses joint Prostheses	16-099 16-150 13-158 13-131
Insufflator	for Laparoscopy	16-849
Suction-Irrigation	for Endoscopy	17-424
Pumps	for Arthroscopy, for Hysteroscopy and for Urology	17-233 17-677 17-677

This annex (Issued: 2007-09-27) is only valid in connection
with the above-mentioned certificate.



C E R T I F I C A T E

DQS GmbH

Deutsche Gesellschaft zur Zertifizierung von Managementsystemen

hereby certifies that the company

REDA Instrumente GmbH

Gänsäcker 34
78532 Tuttlingen
Germany

has implemented and maintains a

Quality Management System

with respect to the aspects of manufacture concerned
with securing and maintaining sterile conditions.

An audit, documented in a report, performed by DQS
has verified that this quality management system
fulfills the requirements of

Annex V of Directive 93/42/EEC

with respect to the following medical devices:

scalpel blades sterile (UMDNS 12-252)

As set out in section 4, Annex V, of the said directive,
the manufacture of these devices is subject to surveillance.

This certificate is valid until 2010-04-27

Certificate Registration No. 070894 MR5s

Frankfurt am Main 2005-04-28



Ass. iur. M. Drechsel

MANAGING DIRECTORS



Dipl.-Ing. S. Heinloth

D-60433 Frankfurt am Main, August-Schanz-Straße 21

EC code number of DQS as notified body: 0297

03112-00.....5	05151-01.....27	05310-03.....37	07224-00.....43	09120-11.....51
03112-01.....5	05151-02.....27	05310-04.....37	07225-00.....43	09120-13.....51
03112-02.....5	05160-01.....28	05311-01.....37	07290-09.....45	09120-14.....51
03113-00.....6	05160-02.....28	05311-02.....37	07291-11.....45	09120-15.....51
03113-01.....6	05160-03.....28	05311-03.....37	07294-13.....45	09120-16.....51
03113-02.....6	05160-04.....28	05311-04.....37	07296-00.....45	09120-18.....51
03114-00.....7	05170-24.....28	05320-01.....37	07402-01.....46	09120-20.....51
03114-01.....7	05190-17.....28	05320-02.....37	07402-02.....46	09121-11.....51
03114-02.....7	05190-20.....28	05320-03.....37	07402-03.....46	09121-13.....51
03120-00.....8	05190-25.....28	05320-04.....37	07402-04.....46	09121-14.....51
03122-00.....9	05203-00.....31	05321-01.....37	07402-05.....46	09121-15.....51
03126-00.....10	05204-00.....31	05321-02.....37	07402-06.....46	09121-16.....51
03132-00.....11	05210-00.....29	05321-03.....37	07402-07.....46	09121-18.....51
03132-01.....11	05210-01.....29	05321-04.....37	07402-08.....46	09121-20.....51
03132-02.....11	05210-02.....29	07103-00.....38	07402-09.....46	09124-14.....51
03133-00.....12	05210-03.....29	07103-01.....38	07402-10.....46	09125-14.....51
03133-01.....12	05210-04.....29	07103-02.....38	07403-01.....47	09128-14.....52
03133-02.....12	05211-00.....29	07104-00.....39	07403-02.....47	09130-14.....52
03161-00.....13	05211-01.....29	07104-02.....39	07410-05.....47	09131-14.....52
03161-01.....14	05211-02.....29	07105-02.....39	07412-05.....47	09140-14.....52
03161-02.....15	05211-03.....29	07106-01.....39/1	07420-08.....48	09141-14.....52
03161-03C.....16	05211-04.....29	07106-02.....39/1	07421-09.....48	09150-14.....52
03161-03T.....16	05220-00.....29	07107-00.....39/2	07422-19.....48	09151-14.....52
03167-03.....20	05220-01.....29	07107-01.....39/2	07423-16.....48	09160-14.....52
03171-00.....17	05220-02.....29	07107-03.....39/2	07423-20.....48	09160-17.....52
03171-01.....17	05220-03.....29	07107-04.....39/2	07423-24.....48	09160-23.....52
03171-02.....17	05220-04.....29	07108-00.....40	07424-11.....48	09161-14.....52
03180-90.....21	05221-00.....29	07109-03.....40	07424-14.....48	09161-17.....52
03180-92.....21	05221-01.....29	07109-10.....41	07424-17.....48	09161-23.....52
03180-93.....21	05221-02.....29	07109-13.....41	07425-11.....48	09164-14.....52
03180-94.....21	05221-03.....29	07109-15.....41	07490-00.....49	09164-17.....52
03195-00.....22	05221-04.....29	07110-00.....42	07490-01.....49	09164-23.....52
03195-01.....22	05223-00.....31	07111-00.....42	07490-02.....49	09165-14.....52
03195-04.....22	05224-00.....31	07112-00.....42	07495-31.....50	09165-17.....52
03195-06.....22	05230-00.....30	07113-00.....42	07496-00.....49	09165-23.....52
03195-07.....22	05230-01.....30	07115-00.....42	07496-31.....50	09170-15.....52
03195-08.....22	05230-02.....30	07116-00.....42	07498-00.....50	09170-17.....52
03195-09.....22	05230-03.....30	07118-00.....42	07499-00.....50	09170-21.....52
03195-10.....22	05230-04.....30	07119-00.....42	07499-01.....50	09171-15.....52
03246-00.....23	05233-18.....32	07120-00.....42	09102-11.....51	09171-17.....52
03246-01.....23	05234-28.....32	07121-00.....42	09102-13.....51	09171-21.....52
03246-02.....23	05234-37.....32	07122-00.....42	09102-14.....51	09174-15.....52
03248-00.....23	05238-01.....32	07123-00.....42	09102-15.....51	09174-17.....52
03260-15.....23	05238-02.....33	07124-00.....42	09102-16.....51	09174-21.....52
03262-18.....23	05238-03.....33	07125-00.....42	09102-18.....51	09175-15.....52
03288-17.....24	05239-01.....29, 30	07130-00.....42	09102-20.....51	09175-17.....52
03288-20.....24	05239-02.....29, 30	07161-00.....41	09103-11.....51	09175-21.....52
03292-22.....24	05239-03.....29, 30	07162-00.....41	09103-13.....51	09180-17.....52
03294-24.....24	05240-30.....34	07165-00.....41	09103-14.....51	09181-17.....52
03304-20.....24	05241-11.....34	07167-00.....41	09103-15.....51	09190-16.....53
03306-17.....24	05241-22.....34	07200-17.....44	09103-16.....51	09191-16.....53
03308-18.....24	05300-01.....36	07200-20.....44	09103-18.....51	09194-16.....53
03310-01.....25	05300-02.....36	07201-13.....44	09103-20.....51	09195-16.....53
03310-02.....25	05300-03.....36	07201-16.....44	09104-14.....51	09202-10.....53
03312-01.....25	05300-04.....36	07201-19.....44	09105-14.....51	09203-10.....53
03314-01.....25	05300-05.....36	07201-22.....44	09110-11.....51	09204-22.....53
03320-19.....25	05300-06.....36	07202-12.....44	09110-13.....51	09206-10.....53
03340-10.....25	05301-01.....35	07203-16.....44	09110-14.....51	09207-10.....53
03340-15.....25	05301-02.....35	07203-19.....44	09110-15.....51	09280-12.....53/1
03340-20.....25	05301-03.....35	07203-22.....44	09110-16.....51	09280-15.....53/1
03340-30.....25	05301-04.....35	07204-11.....44	09110-18.....51	09280-18.....53/1
03340-50.....25	05301-05.....35	07205-09.....44	09110-20.....51	09280-20.....53/1
03350-15.....25	05301-06.....35	07210-00.....43	09111-11.....51	09280-23.....53/1
03360-21.....26	05301-07.....35	07211-00.....43	09111-13.....51	09280-25.....53/1
03361-10.....26	05302-01.....36	07212-00.....43	09111-14.....51	09280-28.....53/1
05130-05.....27	05302-02.....36	07213-00.....43	09111-15.....51	09280-30.....53/1
05130-10.....27	05302-03.....36	07215-00.....43	09111-16.....51	09281-12.....53/1
05140-05.....27	05303-01.....36	07218-00.....43	09111-18.....51	09281-15.....53/1
05140-08.....27	05304-01.....36	07219-00.....43	09111-20.....51	09281-18.....53/1
05150-21.....27	05310-01.....37	07220-00.....43	09114-14.....51	09281-20.....53/1
05150-27.....27	05310-02.....37	07222-00.....43	09115-14.....51	09281-23.....53/1

09281-25.....53/1	09346-11.....54	09497-15.....61	09831-12.....67	10012-19.....73
09281-28.....53/1	09347-09.....58	09501-22.....63	09835-12.....67	10013-19.....73
09281-30.....53/1	09348-01.....55	09501-23.....63	09850-10.....68	10014-19.....73
09282-15.....53/1	09348-02.....55	09505-22.....63	09851-10.....68	10015-19.....73
09282-18.....53/1	09348-03.....55	09505-23.....63	09852-10.....68	10016-17.....73
09282-20.....53/1	09348-04.....55	09510-20.....62	09853-10.....68	10017-17.....73
09282-23.....53/1	09348-05.....55	09510-23.....62	09854-11.....69	10018-20.....73
09282-25.....53/1	09348-06.....55	09511-20.....62	09859-16.....69	10019-20.....73
09282-28.....53/1	09349-09.....58	09511-23.....62	09860-16.....69	10020-17.....73
09283-15.....53/1	09349-12.....55	09512-20.....62	09861-16.....69	10021-17.....73
09283-18.....53/1	09350-09.....57	09512-23.....62	09898-20.....69/1	10022-20.....73
09283-20.....53/1	09350-10.....56	09513-20.....62	09901-09.....69/1	10023-20.....73
09283-23.....53/1	09351-09.....57	09513-23.....62	09901-11.....69/1	10024-17.....73
09283-25.....53/1	09352-09.....57	09514-20.....62	09901-14.....69/1	10025-17.....73
09283-28.....53/1	09353-09.....57	09514-23.....62	09901-18.....69/1	10026-20.....73
09284-12.....53/1	09354-10.....57	09515-20.....62	09901-20.....69/1	10027-20.....73
09284-15.....53/1	09355-10.....57	09515-23.....62	09905-14.....69	10028-14.....73
09284-18.....53/1	09356-10.....57	09516-23.....62	09905-18.....69	10029-14.....73
09284-20.....53/1	09357-10.....57	09517-23.....62	09906-18.....69/1	10030-18.....73
09284-23.....53/1	09358-11.....56	09523-24.....62	09906-20.....69/1	10031-18.....73
09284-25.....53/1	09360-11.....58	09525-22.....63	09911-23.....69/1	10032-23.....73
09284-28.....53/1	09361-11.....58	09530-17.....63	09913-20.....69/2	10033-23.....73
09284-30.....53/1	09362-11.....58	09531-17.....63	09913-22.....69/2	10034-14.....73
09285-12.....53/1	09363-11.....58	09536-27.....63	09915-23.....69/2	10035-14.....73
09285-15.....53/1	09370-11.....58	09537-27.....63	09921-16.....69/2	10036-18.....73
09285-18.....53/1	09371-11.....58	09540-16.....58	09921-19.....69/2	10037-18.....73
09285-20.....53/1	09374-11.....58	09541-16.....61	09930-14.....70	10038-23.....73
09285-23.....53/1	09375-11.....58	09542-16.....61	09931-14.....70	10039-23.....73
09285-25.....53/1	09381-11.....58	09543-16.....61	09933-23.....70	10040-18.....74
09285-28.....53/1	09401-18.....58	09548-18.....64	09935-23.....70	10041-18.....74
09285-30.....53/1	09403-15.....58	09550-10.....64	09937-23.....70	10042-18.....74
09286-15.....53/1	09405-16.....59	09551-16.....64	09939-23.....70	10044-14.....74
09286-18.....53/1	09406-16.....59	09553-16.....64	09941-20.....70	10045-14.....74
09286-20.....53/1	09425-17.....59	09560-14.....64	09950-15.....70	10046-14.....74
09286-23.....53/1	09427-17.....59	09560-22.....64	09950-18.....70	10047-14.....74
09286-25.....53/1	09435-18.....59	09580-11.....65	09960-14.....71	10048-14.....74
09286-28.....53/1	09437-19.....59	09581-11.....65	09961-14.....71	10049-14.....74
09287-15.....53/1	09439-17.....59	09582-15.....65	09962-14.....71	10102-11.....75
09287-18.....53/1	09468-15.....59	09583-15.....65	09962-17.....71	10104-11.....75
09287-20.....53/1	09470-11.....59	09601-22.....65	09962-23.....71	10110-12.....75
09287-23.....53/1	09473-21.....59	09610-18.....65	09963-14.....71	10111-12.....75
09287-25.....53/1	09475-00.....60	09611-18.....65	09963-17.....71	10113-11.....75
09287-28.....53/1	09475-25.....60	09613-20.....65/1	09963-23.....71	10115-11.....75
09289-28.....53/2	09475-45.....60	09614-19.....65/1	09964-15.....71	10117-11.....75
09290-25.....53/2	09475-60.....60	09617-13.....65/1	09964-17.....71	10119-10.....75
09291-18.....54	09475-90.....60	09619-17.....65/1	09965-15.....71	10120-16.....76
09291-20.....54	09476-00.....60	09641-30.....65/2	09965-17.....71	10120-18.....76
09291-23.....54	09476-25.....60	09643-19.....65/2	09966-11.....71	10120-22.....76
09295-18.....54	09476-45.....60	09643-25.....65/2	09967-11.....71	10121-16.....76
09295-20.....54	09476-60.....60	09651-24.....65/2	09970-14.....71	10121-18.....76
09295-23.....54	09476-90.....60	09661-23.....65/2	09970-18.....71	10121-22.....76
09302-14.....54	09477-01.....60	09770-18.....66	09970-20.....71	10122-16.....76
09303-14.....54	09478-25.....60	09772-21.....66	09970-23.....71	10122-18.....76
09304-14.....54	09478-45.....60	09774-21.....66	09971-14.....71	10122-22.....76
09305-14.....54	09478-60.....60	09775-13.....66	09971-18.....71	10123-16.....76
09310-12.....54	09479-25.....60	09777-13.....66	09971-20.....71	10123-18.....76
09310-15.....54	09479-45.....60	09802-09.....66	09971-23.....71	10123-22.....76
09312-12.....54	09479-60.....60	09802-11.....66	09980-11.....72	10124-16.....76
09314-12.....54	09480-25.....61	09803-09.....66	09981-11.....72	10124-18.....76
09320-15.....54	09480-40.....61	09803-13.....66	09982-12.....72	10124-22.....76
09321-15.....54	09480-60.....61	09804-14.....66	09983-12.....72	10125-16.....76
09321-18.....54	09481-25.....61	09809-15.....66	09984-11.....72	10125-18.....76
09325-15.....54	09481-40.....61	09820-13.....67	09985-11.....72	10125-22.....76
09340-09.....54	09481-60.....61	09821-13.....67	09986-11.....72	10126-00.....77
09340-10.....54	09490-16.....61	09823-12.....67	09990-14.....72	10126-25.....77
09340-11.....54	09490-23.....61	09824-12.....67	09990-18.....72	10126-45.....77
09341-09.....54	09491-16.....61	09825-12.....67	09993-15.....72	10126-60.....77
09341-10.....54	09491-23.....61	09826-12.....67	09993-18.....72	10126-90.....77
09341-11.....54	09492-16.....61	09827-12.....67	09995-12.....72	10127-00.....77
09344-11.....54	09492-23.....61	09828-12.....67	10010-19.....73	10127-25.....77
09345-11.....54	09496-15.....61	09829-12.....67	10011-19.....73	10127-45.....77

10127-60.....77	11120-20.....81/1	11231-20.....84	11403-04.....90	12340-20.....99
10127-90.....77	11120-25.....81/1	11232-15.....83	11404-04.....90	12340-24.....99
10128-09.....78	11120-30.....81/1	11233-20.....84	11405-05.....90	13001-08.....101
10128-15.....78	11122-12.....81/1	11234-20.....84	11407-07.....90	13001-10.....101
10129-15.....78	11122-13.....81/1	11235-20.....84	11802-09.....91	13001-12.....101
10130-15.....78	11122-14.....81/1	11236-15.....84	11802-10.....91	13002-08.....101
10131-14.....78	11122-15.....81/1	11236-20.....84	11802-11.....91	13002-10.....101
10131-16.....78	11122-18.....81/1	11237-20.....84	11810-07.....91	13002-12.....101
10132-18.....78	11122-21.....81/1	11240-14.....84	11810-09.....91	13005-10.....101
10133-10.....79	11122-25.....81/1	11242-14.....84	11810-11.....91	13005-14.....101
10135-10.....79	11124-15.....81/1	11246-18.....85	11812-10.....91	13005-20.....101
10137-01.....78	11126-18.....81	11248-18.....85	11813-10.....91	13006-10.....101
10137-02.....78	11126-21.....81	11250-14.....85	11815-12.....91	13006-14.....101
10140-08.....79	11126-25.....81	11252-20.....85	11816-10.....91	13006-20.....101
10141-08.....79	11130-11.....81/1	11256-15.....85	11817-10.....91	13010-30.....102
10142-08.....79	11130-13.....81/1	11256-20.....85	11821-11.....92	13010-35.....102
10143-08.....79	11130-14.....81/1	11256-25.....85	11822-13.....92	13010-40.....102
10151-11.....79	11130-16.....81/1	11257-15.....85	11823-13.....92	13010-50.....102
10153-11.....79	11130-18.....81/1	11258-15.....85	11824-14.....92	13011-30.....102
10155-11.....79	11130-20.....81/1	11259-15.....85	11825-14.....92	13011-35.....102
10202-18.....80	11132-16.....81/1	11260-12.....86	11828-15.....92	13011-40.....102
10203-18.....80	11132-18.....81/1	11260-15.....86	11829-15.....92	13011-50.....102
10313-14.....80	11132-20.....81/1	11261-15.....86	11900-01.....93	13012-30.....102
10313-16.....80	11132-25.....81/1	11270-12.....86	11901-05.....93	13012-35.....102
10320-09.....80	11132-30.....81/1	11270-15.....86	11910-01.....93	13012-40.....102
10330-19.....80	11140-11.....81/1	11271-15.....86	12102-12.....94	13012-50.....102
10331-19.....80	11140-13.....81/1	11271-18.....86	12103-12.....94	13013-30.....102
10333-19.....80	11140-14.....81/1	11272-15.....86	12104-15.....94	13013-35.....102
11102-10.....81	11140-16.....81/1	11273-15.....86	12105-15.....94	13013-40.....102
11102-11.....81	11140-18.....81/1	11274-06.....86	12108-18.....94	13013-50.....102
11102-13.....81	11140-20.....81/1	11274-08.....86	12109-18.....94	13014-30.....102
11102-14.....81	11140-25.....81/1	11274-10.....86	12110-15.....95	13014-35.....102
11102-16.....81	11150-13.....81/1	11302-17.....86	12110-20.....95	13014-40.....102
11102-18.....81	11150-14.....81/1	11302-23.....86	12110-24.....95	13014-50.....102
11102-20.....81	11150-16.....81/1	11303-17.....86	12110-30.....95	13015-30.....102
11102-25.....81	11160-13.....81/1	11304-17.....86	12200-16.....96	13015-35.....102
11102-30.....81	11160-14.....81/1	11305-17.....87	12201-16.....96	13015-40.....102
11103-14.....81	11160-16.....81/1	11310-17.....87	12291-22.....97	13015-50.....102
11104-12.....81	11170-12.....81/2	11311-17.....87	12293-22.....97	13090-40.....100
11104-13.....81	11170-15.....81/2	11312-17.....87	12295-22.....97	13090-45.....100
11104-14.....81	11174-12.....81/2	11312-18.....87	12297-22.....97	13090-50.....100
11104-15.....81	11174-15.....81/2	11313-17.....87	12302-16.....98	13091-40.....100
11104-18.....81	11176-12.....81/2	11314-01.....87	12302-20.....98	13091-45.....100
11104-21.....81	11176-15.....81/2	11314-02.....87	12302-24.....98	13091-50.....100
11104-25.....81	11177-12.....81/2	11315-01.....87	12304-16.....98	13092-07.....103
11106-13.....81	11178-12.....81/2	11315-02.....87	12304-20.....98	13092-08.....103
11106-15.....81	11179-12.....81/2	11316-14.....88	12304-24.....98	13092-10.....103
11110-11.....81	11180-12.....82	11316-16.....88	12304-30.....98	13092-12.....103
11110-13.....81	11180-15.....82	11316-20.....88	12306-16.....98	13093-07.....103
11110-14.....81	11181-12.....82	11317-00.....88	12306-20.....98	13093-08.....103
11110-16.....81	11181-15.....82	11317-12.....88	12306-24.....98	13093-10.....103
11110-18.....81	11186-12.....82	11317-23.....88	12306-30.....98	13093-12.....103
11110-20.....81	11186-15.....82	11318-18.....88	12308-16.....98	13096-06.....103
11110-25.....81	11187-12.....82	11318-20.....88	12308-20.....98	13096-07.....103
11110-30.....81	11187-18.....83	11318-25.....88	12308-24.....98	13096-09.....103
11112-18.....81	11187-20.....83	11319-12.....88	12308-30.....98	13096-11.....103
11112-21.....81	11187-25.....83	11319-14.....88	12309-16.....98	13097-06.....103
11112-25.....81	11187-30.....83	11320-18.....88	12309-20.....98	13097-07.....103
11114-14.....81	11188-12.....82	11320-23.....88	12309-24.....98	13097-09.....103
11114-16.....81	11188-15.....82	11322-15.....89	12309-30.....98	13097-11.....103
11114-20.....81	11189-12.....82	11322-18.....89	12310-16.....98	13098-06.....100
11114-25.....81	11189-15.....83	11322-23.....89	12310-20.....98	13099-07.....100
11116-18.....81	11189-20.....83	11324-23.....89	12310-24.....98	13102-04.....104
11116-21.....81	11189-25.....83	11325-15.....89	12310-30.....98	13102-05.....104
11116-25.....81	11190-10.....83	11325-23.....89	12320-15.....99	13103-04.....104
11120-10.....81/1	11220-17.....83	11325-25.....89	12320-20.....99	13103-05.....104
11120-11.....81/1	11221-17.....83	11326-23.....89	12320-24.....99	13110-50.....104
11120-13.....81/1	11222-17.....83	11328-15.....89	12330-16.....99	13110-55.....104
11120-14.....81/1	11223-17.....83	11328-20.....89	12330-20.....99	13110-65.....104
11120-16.....81/1	11224-17.....83	11401-01.....90	12330-24.....99	13110-70.....104
11120-18.....81/1	11225-17.....83	11403-03.....90	12340-16.....99	13110-75.....104

13110-90.....104	13311-13.....108	13384-20.....112	13451-24.....118	13597-10.....127
13111-50.....104	13311-14.....108	13384-26.....112	13453-18.....118	13597-20.....127
13111-55.....104	13311-16.....108	13385-20.....112	13453-24.....118	13597-30.....127
13111-65.....104	13311-18.....108	13385-26.....112	13455-01.....118	13597-40.....127
13111-70.....104	13311-20.....108	13386-20.....112	13455-02.....118	13598-24.....126
13111-75.....104	13311-22.....108	13386-26.....112	13456-01.....119	13599-24.....126
13111-90.....104	13311-24.....108	13387-20.....112	13456-02.....119	13600-20.....127
13115-00.....104	13311-26.....108	13387-26.....112	13456-03.....119	13601-20.....127
13210-10.....104	13311-30.....108	13390-20.....112	13457-28.....119	13605-26.....128
13211-10.....104	13312-14.....108	13391-20.....112	13459-18.....119	13702-14.....129
13212-10.....104	13312-16.....108	13393-20.....112	13459-28.....119	13704-16.....129
13213-10.....104	13313-14.....108	13394-20.....112	13471-14.....119/1	13704-18.....129
13214-10.....104	13313-16.....108	13395-20.....112	13471-16.....119/1	13710-15.....129
13215-10.....104	13320-13.....108	13410-18.....112	13471-18.....119/1	13710-18.....129
13220-12.....105	13320-14.....108	13411-18.....112	13471-22.....119/1	13710-20.....129
13220-14.....105	13320-16.....108	13412-18.....113	13473-22.....119/1	13712-15.....129
13220-18.....105	13320-18.....108	13413-18.....113	13474-19.....119/1	13712-18.....129
13220-21.....105	13320-20.....108	13414-20.....113	13474-24.....119/1	13712-20.....129
13221-12.....105	13320-22.....108	13415-14.....113	13474-26.....119/1	13720-18.....130
13221-14.....105	13320-24.....108	13415-18.....113	13475-14.....119/1	15101-09.....132
13221-18.....105	13320-26.....108	13416-18.....113	13475-18.....119/1	15103-07.....132
13221-21.....105	13320-30.....108	13420-14.....114	13477-15.....119/2	15103-09.....132
13222-12.....105	13321-13.....108	13421-01.....114	13477-19.....119/2	15105-09.....132
13223-12.....105	13321-14.....108	13421-02.....114	13479-22.....119/2	15107-10.....132
13224-12.....105	13321-16.....108	13421-03.....114	13479-25.....119/2	15107-13.....132
13225-12.....105	13321-18.....108	13421-04.....114	13479-28.....119/2	15108-14.....132
13226-12.....105	13321-20.....108	13421-05.....114	13480-15.....119/2	15111-09.....132
13227-12.....105	13321-22.....108	13421-06.....114	13480-18.....119/2	15111-11.....132
13230-12.....105	13321-24.....108	13421-07.....114	13481-15.....119/2	15111-13.....132
13230-14.....105	13321-26.....108	13422-00.....114	13481-18.....119/2	15111-15.....132
13230-18.....105	13321-30.....108	13422-01.....114	13491-19.....119/2	15115-11.....132
13230-21.....105	13322-14.....108	13422-02.....114	13493-23.....120	15117-13.....132
13231-12.....105	13322-16.....108	13422-03.....114	13495-18.....120	15121-11.....133
13231-14.....105	13323-14.....108	13422-06.....114	13497-20.....120	15121-13.....133
13231-18.....105	13323-16.....108	13425-02.....114	13499-16.....120	15123-11.....133
13231-21.....105	13330-13.....109	13425-03.....114	13501-23.....120	15123-13.....133
13232-12.....105	13330-15.....109	13425-04.....114	13503-21.....121	15125-14.....133
13233-12.....105	13330-18.....109	13425-05.....114	13505-21.....121	15140-16.....133
13240-14.....106	13330-20.....109	13425-06.....114	13507-22.....121	15150-19.....133
13241-14.....106	13331-13.....109	13428-21.....115	13507-23.....121	15161-18.....133
13242-16.....106	13331-15.....109	13431-13.....115	13513-23.....122	15164-15.....133
13243-16.....106	13331-18.....109	13431-16.....115	13515-23.....122	15164-20.....133
13244-14.....106	13331-20.....109	13431-18.....115	13517-23.....122	17110-20.....134
13245-14.....106	13340-16.....109	13431-20.....115	13519-20.....122	17110-25.....134
13250-14.....107	13340-20.....109	13431-23.....115	13519-22.....122	17111-20.....134
13250-18.....107	13341-16.....109	13431-25.....115	13519-24.....122	17111-25.....134
13251-14.....107	13341-20.....109	13431-28.....115	13520-23.....122	17112-20.....134
13251-18.....107	13345-12.....109	13432-19.....116	13520-24.....122	17112-25.....134
13254-14.....107	13345-14.....109	13433-19.....116	13523-23.....123	17113-20.....134
13255-14.....107	13350-16.....109	13434-28.....116	13551-14.....123	17113-25.....134
13256-14.....106	13350-20.....109	13435-28.....116	13551-18.....123	17120-28.....134
13257-14.....106	13351-16.....109	13438-01.....116	13551-20.....123	17121-28.....134
13258-16.....106	13351-20.....109	13438-02.....116	13554-21.....123	17131-21.....134
13259-16.....106	13356-15.....109	13438-03.....116	13555-21.....123	17133-17.....135
13260-14.....107	13358-15.....109	13438-04.....116	13556-24.....123	17160-22.....135
13261-14.....107	13358-20.....109	13441-01.....117	13561-20.....123	17160-25.....135
13262-16.....107	13360-15.....110	13441-02.....117	13563-20.....123	17161-22.....135
13263-16.....107	13364-14.....110	13441-03.....117	13570-23.....124	17161-25.....135
13264-16.....107	13366-19.....110	13441-04.....117	13571-25.....124	17170-18.....136
13265-16.....107	13368-14.....110	13442-21.....117	13573-22.....124	17170-20.....136
13270-14.....106	13368-16.....110	13442-26.....117	13574-24.....125	17170-25.....136
13271-14.....106	13370-13.....110	13443-21.....117	13575-24.....125	17171-18.....136
13310-13.....108	13372-13.....110	13443-26.....117	13579-21.....125	17171-20.....136
13310-14.....108	13374-14.....110	13444-21.....117	13580-60.....126	17171-25.....136
13310-16.....108	13376-16.....110	13444-26.....117	13580-80.....126	17172-18.....136
13310-18.....108	13377-25.....111	13445-21.....117	13591-20.....126	17172-25.....136
13310-20.....108	13377-26.....111	13445-26.....117	13593-20.....126	17173-18.....136
13310-22.....108	13380-15.....111	13447-20.....117	13595-10.....127	17173-25.....136
13310-24.....108	13381-15.....111	13448-22.....117	13595-20.....127	17174-25.....136
13310-26.....108	13382-15.....111	13449-22.....117	13595-30.....127	17175-25.....136
13310-30.....108	13383-15.....111	13450-24.....118	13595-40.....127	17180-18.....136

17180-25.....136	19171-40.....143	19229-02.....150	19299-01.....156	19372-22.....163
17207-13.....137	19171-50.....143	19229-03.....150	19300-02.....156	19374-45.....163
17210-13.....137	19171-60.....143	19230-10.....151	19300-03.....156	19374-55.....163
17210-16.....137	19171-70.....143	19230-12.....151	19300-04.....156	19374-65.....163
17210-18.....137	19172-30.....143/1	19230-14.....151	19300-06.....156	19378-25.....163
17220-25.....137	19173-20.....143/1	19230-16.....151	19301-02.....156	19380-35.....163
17226-25.....137	19173-30.....143/1	19230-18.....151	19301-03.....156	19380-50.....163
17227-25.....137	19173-40.....143/1	19231-11.....151	19301-04.....156	19381-50.....163
17229-25.....137	19174-17.....143/1	19231-13.....151	19301-06.....156	19382-50.....163
17230-26.....138	19174-25.....143/1	19231-15.....151	19302-01.....157	19385-38.....164
17231-26.....138	19174-37.....143/1	19232-08.....151	19302-02.....157	19385-57.....164
17233-26.....138	19174-40.....143/1	19232-10.....151	19302-03.....157	19388-40.....164
19102-12.....139	19175-28.....143/1	19232-12.....151	19302-04.....157	19388-50.....164
19102-15.....139	19176-25.....143/2	19232-14.....151	19302-05.....157	19388-65.....164
19104-15.....139	19177-27.....143/2	19232-16.....151	19302-06.....157	19400-01.....165
19110-13.....139	19178-28.....143/2	19232-18.....151	19304-19.....157	19400-02.....165
19110-18.....139	19179-28.....144	19233-08.....152	19306-20.....157	19400-03.....165
19120-00.....139	19180-19.....145	19233-11.....152	19307-01.....157	19480-22.....164
19120-14.....139	19181-22.....145	19233-15.....152	19307-02.....157	19480-27.....164
19120-15.....139	19181-25.....145	19233-17.....152	19310-01.....158	19482-45.....164
19120-17.....139	19183-25.....145	19233-20.....152	19310-02.....158	19482-73.....164
19122-13.....140	19185-25.....145	19233-23.....152	19310-03.....158	19482-82.....164
19123-11.....140	19187-25.....145	19234-20.....153	19310-04.....158	19484-01.....164
19124-15.....140	19187-38.....146	19235-21.....153	19310-05.....158	19484-02.....164
19125-14.....140	19187-50.....146	19236-01.....153	19312-01.....158	19490-22.....166
19126-13.....140	19187-75.....146	19236-02.....153	19312-02.....158	19490-43.....166
19127-11.....140	19189-25.....146	19236-08.....152	19312-03.....158	19490-65.....166
19131-21.....141	19189-38.....146	19236-10.....152	19312-04.....158	19492-25.....164
19132-15.....141	19189-50.....146	19236-12.....152	19312-05.....158	19493-80.....167
19134-20.....141	19189-75.....146	19236-14.....152	19314-07.....159	19494-00.....167
19135-19.....141	19190-64.....147	19236-16.....152	19314-10.....159	19494-12.....167
19137-16.....141	19191-25.....147	19236-18.....152	19314-12.....159	19494-13.....167
19140-00.....142	19191-40.....147	19240-10.....153	19314-14.....159	19494-14.....167
19140-01.....142	19191-62.....147	19240-20.....153	19314-15.....159	19494-16.....167
19140-02.....142	19192-23.....147	19250-16.....153	19314-16.....159	19494-18.....167
19150-01.....142	19195-01.....148	19250-24.....153	19314-20.....159	19494-45.....166
19150-02.....142	19195-02.....148	19270-02.....153	19315-06.....159	19494-60.....166
19150-03.....142	19195-03.....148	19270-03.....153	19315-21.....159	19494-75.....166
19150-04.....142	19210-12.....149	19270-04.....153	19317-21.....159	19495-60.....167
19152-25.....142	19211-12.....149	19270-06.....153	19318-40.....159	19495-80.....167
19152-31.....142	19212-01.....149	19271-02.....153	19318-57.....159	19496-00.....167
19152-38.....142	19212-02.....149	19271-03.....153	19318-78.....159	19496-12.....167
19152-51.....142	19214-13.....149	19271-04.....153	19330-40.....158	19496-14.....167
19152-64.....142	19214-18.....149	19271-06.....153	19330-55.....158	19496-50.....166
19158-51.....142	19215-01.....149	19280-01.....154	19332-19.....160	19496-90.....166
19158-64.....142	19215-02.....149	19280-02.....154	19332-21.....160	19497-14.....167
19158-76.....142	19215-03.....149	19280-03.....154	19340-10.....160	19498-01.....167
19158-82.....142	19215-13.....149	19280-04.....154	19340-15.....160	19498-02.....167
19159-50.....142	19215-18.....149	19280-06.....154	19340-20.....160	19498-03.....167
19159-64.....142	19216-01.....149	19281-01.....154	19344-14.....160	19610-07.....168
19159-70.....142	19216-02.....149	19281-02.....154	19344-20.....160	19611-07.....168
19159-90.....142	19216-05.....149	19281-03.....154	19344-26.....160	19620-07.....168
19160-17.....143	19216-07.....149	19281-04.....154	19345-01.....160	19620-10.....168
19161-17.....143	19216-10.....149	19281-06.....154	19345-02.....160	19621-07.....168
19168-06.....143	19217-03.....149	19282-02.....154	19345-03.....160	19621-10.....168
19168-08.....143	19217-05.....149	19282-03.....154	19348-22.....160	19630-10.....168
19168-10.....143	19217-07.....149	19282-04.....154	19350-35.....161	19631-10.....168
19168-12.....143	19220-01.....150	19282-06.....154	19350-60.....161	19634-10.....168
19168-17.....143	19220-02.....150	19296-01.....155	19350-70.....161	19635-10.....168
19168-20.....143	19220-03.....150	19296-02.....155	19360-04.....162	19636-14.....168
19168-25.....143	19220-04.....150	19296-03.....155	19364-40.....162	19637-14.....168
19169-25.....143	19221-01.....150	19296-04.....155	19364-50.....162	19640-14.....169
19170-20.....143	19221-02.....150	19296-06.....155	19364-60.....162	19641-14.....169
19170-25.....143	19221-03.....150	19296-08.....155	19364-70.....162	19650-10.....169
19170-32.....143	19221-04.....150	19297-01.....155	19366-08.....162	19651-10.....169
19170-40.....143	19226-02.....150	19297-02.....155	19367-08.....162	19654-13.....169
19170-45.....143	19226-03.....150	19297-03.....155	19370-40.....163	19655-13.....169
19170-50.....143	19226-04.....150	19297-04.....155	19370-50.....163	19670-14.....169
19170-65.....143	19227-02.....150	19297-06.....155	19370-60.....163	19670-16.....169
19170-76.....143	19227-03.....150	19297-08.....155	19370-75.....163	19670-20.....169
19171-30.....143	19227-04.....150	19298-01.....156	19370-85.....163	19670-24.....169

19671-14.....169	19724-55.....179	19798-01.....188	19960-01.....197	21154-04.....202
19671-16.....169	19724-60.....179	19798-02.....188	19960-02.....197	21154-05.....202
19671-20.....169	19725-40.....179	19798-03.....188	19960-03.....197	21154-06.....202
19671-24.....169	19725-45.....179	19798-04.....188	19960-04.....197	21160-04.....202
19672-11.....171	19725-50.....179	19799-01.....189	19960-05.....197	21160-06.....202
19673-11.....171	19725-55.....179	19799-02.....189	19960-06.....197	21160-07.....202
19674-15.....171	19725-60.....179	19799-03.....189	19970-01.....198	21160-08.....202
19675-00.....170	19744-00.....180	19799-04.....189	19980-01.....197	21160-10.....202
19675-13.....171	19744-17.....180	19799-05.....189	19980-02.....197	21160-12.....202
19676-00.....170	19745-40.....180	19799-06.....189	19980-03.....197	21160-14.....202
19677-13.....171	19745-45.....180	19800-01.....189/1	19980-04.....197	21162-12.....203
19677-19.....170	19745-50.....180	19800-02.....189/1	19980-05.....197	21190-14.....203
19677-25.....170	19745-55.....180	19800-03.....189/1	19980-06.....197	21270-12.....203
19677-32.....170	19745-60.....180	19800-04.....189/1	19980-18.....198	21270-14.....203
19678-05.....170	19745-65.....180	19802-09.....189/1	19990-18.....198	21270-16.....203
19678-06.....170	19745-70.....180	19802-11.....189/1	19995-22.....198	21270-18.....203
19678-16.....171	19747-45.....180	19802-14.....189/1	19995-38.....198	21270-23.....203
19679-20.....172	19747-50.....180	19802-16.....189/1	19998-03.....198	21272-12.....203
19679-22.....172	19747-55.....180	19802-18.....189/1	19998-05.....198	21272-14.....203
19680-19.....172	19747-60.....180	19803-14.....189/1	21102-11.....199	21272-16.....203
19681-19.....172	19747-65.....180	19804-18.....189/2	21102-13.....199	21272-18.....203
19681-21.....172	19748-01.....180	19805-18.....189/2	21102-14.....199	21272-23.....203
19682-26.....173	19748-02.....180	19806-18.....189/2	21102-16.....199	21290-12.....203
19683-26.....173	19748-03.....180	19810-22.....190	21102-18.....199	21290-14.....203
19684-14.....173	19748-04.....180	19812-60.....190	21102-20.....199	21290-16.....203
19684-16.....173	19754-00.....181	19813-00.....191	21102-25.....199	21290-18.....203
19684-20.....173	19758-85.....181	19816-00.....191	21104-11.....199	21292-12.....203
19684-26.....173	19759-00.....181	19820-01.....195	21104-13.....199	21292-14.....203
19685-14.....173	19760-14.....181	19820-02.....193, 195	21104-14.....199	21292-16.....203
19685-16.....173	19762-16.....181	19820-03.....193, 195	21104-16.....199	21292-18.....203
19685-20.....173	19764-18.....182	19820-10.....193, 195	21104-18.....199	21310-15.....203
19685-26.....173	19764-20.....182	19820-20.....193, 194	21104-20.....199	21320-12.....203
19686-32.....174	19764-25.....182	19820-90.....192, 193	21104-25.....199	21320-18.....203
19687-01.....175	19765-01.....183	19820-91.....192, 193	21106-11.....199	21331-25.....203
19687-02.....175	19765-02.....183	19820-99.....193	21106-13.....199	21340-45.....203
19688-01.....175	19765-03.....183	19821-01.....193	21106-14.....199	23104-00.....204
19688-02.....175	19765-04.....183	19821-02.....193	21106-16.....199	23110-30.....204
19689-01.....175/1	19766-90.....182	19821-03.....193	21106-18.....199	23110-35.....204
19689-02.....175/1	19767-01.....184	19821-04.....193, 195	21106-20.....199	23110-40.....204
19690-31.....176	19767-02.....184	19822-01.....193	21106-25.....199	23110-45.....204
19692-32.....176	19767-18.....184	19822-02.....193	21108-14.....199	23110-50.....204
19694-01.....177	19770-01.....186	19822-21.....194	21109-18.....199	23110-55.....204
19694-02.....177	19770-02.....186	19822-22.....194	21110-13.....199	23110-60.....204
19694-03.....177	19770-03.....186	19822-22L.....194	21110-14.....199	23123-30.....204
19696-18.....178	19770-04.....186	19822-23.....193	21110-16.....199	23123-40.....204
19698-18.....178	19770-05.....186	19822-24.....193	21110-18.....199	23123-50.....204
19710-00.....178	19771-00.....185	19822-25.....193, 194	21110-20.....199	23125-11.....204
19710-01.....178	19771-01.....185	19822-26.....193, 194	21111-14.....199	23128-19.....204
19710-40.....178	19771-02.....185	19824-06.....193, 194	21112-14.....199	23140-02.....204
19710-45.....178	19771-03.....185	19825-06.....193, 194	21115-10.....199	23150-10.....205
19710-50.....178	19772-00.....185	19826-06.....193, 194	21120-16.....199	23150-12.....205
19710-55.....178	19772-03.....185	19831-25.....193, 194	21121-14.....199	23150-14.....205
19710-60.....178	19780-01.....186	19833-33.....193, 194	21121-18.....199	23150-16.....205
19711-00.....178	19781-55.....185	19834-01.....193, 194	21122-13.....199	23150-18.....205
19711-01.....178	19781-65.....185	19902-10.....267	21122-18.....199	23150-20.....205
19711-40.....178	19782-00.....185	19903-00.....267	21125-01.....200	23170-25.....205
19711-45.....178	19783-00.....187	19910-00.....196	21125-02.....200	23170-30.....205
19711-50.....178	19783-01.....187	19911-00.....196	21125-03.....200	23170-33.....205
19711-55.....178	19783-24.....185	19912-50.....196	21125-04.....200	23170-35.....205
19711-60.....178	19784-30.....187/1	19912-70.....196	21150-00.....201	23180-27.....205
19712-00.....178	19784-40.....187/1	19913-50.....196	21150-02.....201	23180-40.....205
19713-00.....178	19784-50.....187/1	19913-70.....196	21150-03.....201	23181-40.....205
19720-00.....179	19784-60.....187/1	19914-41.....196	21150-06.....201	23195-08.....207
19720-15.....179	19784-78.....187/1	19914-67.....196	21150-09.....201	23195-10.....207
19721-00.....179	19784-80.....187/1	19915-48.....196	21150-12.....201	23195-12.....207
19721-15.....179	19784-98.....187/1	19915-64.....196	21150-15.....201	23195-14.....207
19724-00.....179	19784-99.....187/1	19916-64.....196	21150-80.....201	23195-16.....207
19724-11.....179	19790-01.....187	19916-80.....196	21150-90.....201	23195-18.....207
19724-40.....179	19790-02.....187	19917-64.....196	21154-01.....202	23197-08.....207
19724-45.....179	19795-01.....188	19918-64.....196	21154-02.....202	23197-10.....207
19724-50.....179	19795-02.....188	19918-88.....196	21154-03.....202	23197-12.....207

23197-14.....207	25184-24.....209	25436-13.....212	27120-24.....218	27423-02.....222
23197-16.....207	25184-26.....209	25438-13.....212	27120-27.....218	27423-03.....222
23197-18.....207	25184-30.....209	25438-15.....213	27121-21.....218	27423-04.....222
23198-08.....207	25190-16.....209	25446-25.....213	27121-24.....218	27423-05.....222
23198-10.....207	25190-18.....209	25447-25.....213	27121-27.....218	27423-06.....222
23198-12.....207	25190-20.....209	25450-14.....213	27130-13.....219	27423-07.....222
23198-14.....207	25194-16.....209	25450-17.....213	27131-13.....219	27423-08.....222
23198-16.....207	25194-18.....209	25450-20.....213	27133-24.....219	27423-09.....222
23198-18.....207	25194-20.....209	25450-24.....213	27134-32.....219	27433-01.....222
23210-00.....206	25196-13.....209	25452-14.....213	27135-24.....219	27433-02.....222
23250-20.....206	25196-18.....209	25452-17.....213	27139-19.....219	27433-03.....222
23250-40.....206	25214-16.....210	25452-20.....213	27201-15.....220	27433-04.....222
23302-01.....206	25214-18.....210	25452-24.....213	27201-19.....220	27433-05.....222
23302-02.....206	25214-20.....210	25460-18.....213	27201-21.....220	27433-06.....222
23302-03.....206	25214-23.....210	25460-20.....213	27202-15.....220	27433-07.....222
23302-04.....206	25214-26.....210	25460-23.....213	27202-19.....220	27433-08.....222
23302-05.....206	25214-31.....210	25465-20.....213	27202-21.....220	27433-09.....222
23302-06.....206	25224-13.....210	25465-25.....213	27203-15.....220	27433-10.....222
23302-07.....206	25224-15.....210	25466-17.....213	27203-19.....220	27433-11.....222
23302-08.....206	25224-18.....210	25466-20.....213	27203-21.....220	27433-12.....222
23310-14.....206	25224-20.....210	25467-17.....213	27204-15.....220	27433-13.....222
23310-18.....206	25224-23.....210	25467-20.....213	27204-19.....220	27433-14.....222
23330-14.....206	25224-26.....210	25610-11.....214	27204-21.....220	27433-15.....222
23330-20.....206	25225-13.....210	25612-13.....214	27240-00.....220	27433-16.....222
23350-20.....206	25225-15.....210	25612-15.....214	27240-01.....220	27434-01.....222
23350-30.....206	25225-18.....210	25614-12.....214	27240-02.....220	27434-02.....222
23351-20.....206	25225-20.....210	25615-12.....214	27240-03.....220	27434-03.....222
23351-30.....206	25225-23.....210	25620-16.....214	27271-19.....221	27434-04.....222
23352-15.....206	25225-26.....210	25621-16.....214	27273-19.....221	27434-05.....222
23352-20.....206	25230-18.....210	25624-16.....214	27275-30.....221	27434-06.....222
25110-12.....208	25230-20.....210	25625-16.....214	27277-25.....221	27434-07.....222
25114-12.....208	25230-23.....210	25627-14.....214	27285-20.....221	27434-08.....222
25120-12.....208	25241-21.....210	25628-14.....214	27288-22.....221	27434-09.....222
25122-12.....208	25241-26.....210	25650-10.....216	27289-22.....221	27434-10.....222
25128-13.....208	25245-21.....210	25651-10.....216	27291-18.....221	27434-11.....222
25129-13.....208	25245-26.....210	25656-10.....216	27291-27.....221	27434-12.....222
25130-13.....208	25250-27.....210	25657-10.....216	27297-23.....221	27434-13.....222
25134-13.....208	25254-27.....210	25660-13.....217	27298-23.....221	27434-14.....222
25136-11.....208	25260-27.....210	25661-13.....217	27403-01.....222	27434-15.....222
25137-11.....208	25264-27.....210	25667-18.....215	27403-02.....222	27434-16.....222
25140-13.....208	25285-20.....211	25667-21.....215	27403-03.....222	27441-01.....223
25144-13.....208	25285-24.....211	25668-18.....215	27403-04.....222	27441-02.....223
25146-13.....208	25285-26.....211	25668-21.....215	27403-05.....222	27441-03.....223
25148-13.....208	25290-18.....211	25670-14.....215	27403-06.....222	27441-04.....223
25150-12.....208	25292-18.....211	25671-14.....215	27403-07.....222	27441-05.....223
25150-14.....208	25293-27.....211	25672-14.....215	27403-08.....222	27441-06.....223
25154-12.....208	25311-20.....211	25673-14.....215	27403-09.....222	27441-07.....223
25154-14.....208	25311-27.....211	25676-14.....215	27403-10.....222	27441-08.....223
25160-15.....209	25315-20.....211	25677-14.....215	27403-11.....222	27441-09.....223
25160-18.....209	25315-27.....211	25678-09.....215	27403-12.....222	27441-10.....223
25160-20.....209	25324-18.....211	25678-14.....216	27403-13.....222	27441-11.....223
25160-23.....209	25324-26.....211	25679-09.....215	27403-14.....222	27441-12.....223
25164-15.....209	25330-21.....212	25679-14.....216	27403-15.....222	27443-01.....223
25164-18.....209	25330-23.....212	25680-13.....215	27403-16.....222	27443-02.....223
25164-20.....209	25334-23.....212	25684-13.....215	27413-01.....222	27443-03.....223
25164-23.....209	25405-12.....212	25700-18.....217	27413-02.....222	27443-04.....223
25170-15.....209	25406-12.....212	25701-18.....217	27413-03.....222	27443-05.....223
25174-15.....209	25407-12.....212	25720-14.....217	27413-04.....222	27443-10.....223
25180-12.....209	25408-12.....212	25721-14.....217	27413-05.....222	27443-20.....223
25180-14.....209	25410-14.....212	25722-14.....217	27413-06.....222	27443-30.....223
25180-16.....209	25410-17.....212	25723-14.....217	27413-07.....222	27450-01.....223
25180-18.....209	25414-14.....212	25730-18.....217	27413-08.....222	27450-02.....223
25180-20.....209	25414-17.....212	25731-18.....217	27413-09.....222	27450-03.....223
25180-24.....209	25414-18.....212	27109-20.....218	27413-10.....222	27450-04.....223
25180-26.....209	25415-14.....212	27110-21.....218	27413-11.....222	27450-05.....223
25180-30.....209	25415-17.....212	27110-24.....218	27413-12.....222	27450-06.....223
25184-12.....209	25415-20.....212	27110-27.....218	27413-13.....222	27452-01.....223
25184-14.....209	25430-16.....212	27111-21.....218	27413-14.....222	27452-02.....223
25184-16.....209	25434-11.....212	27111-24.....218	27413-15.....222	27452-03.....223
25184-18.....209	25434-13.....212	27111-27.....218	27413-16.....222	27452-04.....223
25184-20.....209	25434-16.....212	27120-21.....218	27423-01.....222	27452-05.....223

27452-06.....223	31210-50.....230	33245-23.....240	33412-24.....247	33477-03.....253
27465-10.....223	31210-65.....230, 231/2	33247-23.....240	33413-14.....247	33477-04.....253
27465-20.....223	31211-50.....230	33251-26.....240	33414-21.....247	33477-05.....253
27467-01.....223	31211-65.....230	33253-26.....240	33415-23.....248	33477-06.....253
27467-02.....223	31212-02.....230, 231-3	33257-23.....240	33415-25.....248	33478-98.....253
27467-03.....223	31250-00.....231	33258-23.....240	33415-28.....248	33478-99.....253
27467-04.....223	31350-28.....232	33259-23.....240	33416-17.....248	33479-00.....253
27467-05.....223	31360-30.....232	33260-24.....240	33417-18.....248	33479-01.....253
27475-10.....223	31362-28.....232	33261-22.....240	33420-20.....249	33479-02.....253
27475-20.....223	31366-23.....232	33274-14.....241	33421-20.....249	33479-03.....253
27477-01.....223	31370-20.....233	33274-17.....241	33423-23.....249	33479-04.....253
27477-02.....223	31380-18.....233	33274-19.....241	33424-10.....249	33479-05.....253
27477-03.....223	31390-18.....233	33274-22.....241	33441-13.....249	33479-06.....253
27477-04.....223	31395-18.....233	33275-14.....241	33441-18.....249	33480-97.....254
27477-05.....223	31397-24.....233	33275-17.....241	33441-20.....249	33480-98.....254
27485-10.....223	33100-01.....234	33275-19.....241	33442-19.....250	33481-00.....254
27485-20.....223	33100-02.....234	33275-22.....241	33443-18.....250	33481-01.....254
27487-01.....223	33101-12.....234	33280-15.....241	33444-15.....250	33481-02.....254
27487-02.....223	33101-14.....234	33281-15.....241	33450-01.....250	33481-03.....254
27487-03.....223	33102-01.....234	33282-19.....241	33450-02.....250	33481-04.....254
27487-04.....223	33102-02.....234	33283-17.....241	33467-97.....251	33481-05.....254
27487-05.....223	33103-14.....235	33284-15.....241	33467-98.....251	33481-06.....254
27610-12.....224	33105-17.....235	33286-18.....241	33468-00.....251	33482-01.....253
27612-12.....224	33107-16.....235	33289-18.....241	33468-01.....251	33482-02.....253
27614-12.....224	33109-16.....235	33290-23.....242	33468-02.....251	33482-03.....253
27616-12.....224	33115-15.....236	33290-27.....242	33468-03.....251	33482-97.....254
27620-18.....224	33117-15.....236	33291-23.....242	33468-04.....251	33482-98.....254
27630-12.....224	33119-15.....236	33291-27.....242	33469-96.....251	33483-00.....254
27640-13.....224	33131-15.....236	33292-26.....242	33469-97.....251	33483-01.....254
27642-14.....224	33133-15.....236	33293-27.....242	33469-98.....251	33483-02.....254
27660-07.....224	33136-17.....236	33295-24.....242	33470-00.....251	33483-03.....254
27660-11.....224	33137-17.....236	33360-21.....243	33470-01.....251	33483-04.....254
27660-12.....224	33142-20.....236	33362-21.....243	33470-02.....251	33483-05.....254
27660-14.....224	33143-20.....236	33365-19.....243	33470-03.....251	33483-06.....254
27660-16.....224	33147-20.....237	33366-19.....243	33470-04.....251	33484-97.....254
27660-18.....224	33148-18.....237	33366-23.....243	33470-05.....251	33484-98.....254
27660-20.....224	33150-16.....237	33366-26.....243	33470-06.....251	33485-00.....254
27660-22.....224	33151-16.....237	33368-26.....243	33471-96.....251	33485-01.....254
27670-00.....225	33152-17.....237	33370-22.....244	33471-97.....251	33485-02.....254
27680-00.....226	33153-17.....237	33370-27.....244	33471-98.....251	33485-03.....254
29102-16.....227	33154-18.....237	33370-30.....244	33472-00.....251	33485-04.....254
29102-20.....227	33155-18.....237	33372-22.....244	33472-01.....251	33485-05.....254
29102-24.....227	33156-18.....237	33372-26.....244	33472-02.....251	33485-06.....254
29110-27.....227	33157-02.....237	33372-33.....244	33472-03.....251	33485-21.....255
29120-20.....227	33157-03.....237	33378-15.....244	33472-04.....251	33485-99.....255
29120-28.....227	33157-04.....238	33378-17.....244	33472-05.....251	33486-00.....255
29121-20.....227	33157-05.....238	33378-21.....244	33472-06.....251	33486-01.....255
29121-28.....227	33157-06.....238	33380-15.....244	33473-01.....252	33486-02.....255
29130-23.....227	33158-03.....238	33380-17.....244	33473-02.....252	33486-99.....255
29140-20.....227	33158-04.....238	33380-21.....244	33473-03.....252	33487-00.....255
29140-30.....227	33158-05.....238	33382-33.....244	33473-04.....252	33487-01.....255
29145-55.....227	33159-03.....238	33382-45.....244	33473-05.....252	33487-02.....255
29150-12.....227, 624	33159-04.....238	33384-33.....244	33473-06.....252	33487-99.....255
29152-14.....227, 624	33159-05.....238	33384-45.....244	33474-96.....251	33488-00.....255
31101-24.....229	33201-18.....238	33391-15.....245	33474-97.....251	33488-01.....255
31103-23.....229	33202-18.....238	33391-19.....245	33474-98.....251	33488-02.....255
31103-26.....229	33205-18.....238	33391-24.....245	33475-00.....251	33489-00.....255
31103-37.....229	33211-15.....238	33391-26.....245	33475-01.....251	33489-01.....255
31120-19.....229	33213-15.....238	33391-28.....245	33475-02.....251	33489-02.....255
31130-14.....229	33216-18.....239	33395-17.....245	33475-03.....251	33489-03.....255
31201-11.....231/1	33217-18.....239	33395-25.....245	33475-04.....251	33490-10.....256
31201-22.....231/1	33219-23.....239	33395-26.....245	33475-05.....251	33490-20.....256
31201-39.....231/1, 231/3	33220-20.....239	33395-27.....245	33475-06.....251	33490-30.....256
31201-58.....231/1, 231/3	33230-22.....239	33402-17.....246	33476-01.....253	33490-40.....256
31202-16.....231/1, 231/3	33230-26.....239	33404-20.....246	33476-02.....253	33490-50.....256
31203-50.....231/2	33231-22.....239	33405-20.....246	33476-03.....253	33491-01.....256
31204-01.....231/2	33231-26.....239	33406-20.....246	33476-98.....253	33491-02.....256
31205-08.....231/2	33235-23.....239	33407-19.....246	33476-99.....253	33491-03.....256
31205-20.....231/2	33237-23.....239	33409-13.....246	33477-00.....253	33491-04.....256
31210-21.....230	33241-30.....240	33410-19.....246	33477-01.....253	33491-05.....256
31210-22.....230	33243-30.....240	33412-16.....247	33477-02.....253	33491-06.....256

33491-07.....256	33620-07.....259	33644-19.....261	33660-15.....263	33675-19.....265
33491-08.....256	33620-08.....259	33644-25.....261	33660-20.....263	33675-25.....265
33492-13.....257	33622-02.....259	33644-32.....261	33660-25.....263	33675-32.....265
33492-16.....257	33622-03.....259	33645-06.....261	33660-30.....263	33676-01.....266
33492-20.....257	33622-04.....259	33645-09.....261	33661-07.....263	33676-02.....266
33494-13.....257	33622-05.....259	33645-13.....261	33661-10.....263	33676-05.....266
33494-14.....257	33622-06.....259	33645-16.....261	33661-15.....263	33676-10.....266
33494-17.....257	33622-07.....259	33645-19.....261	33661-20.....263	33676-16.....266
33495-16.....257	33622-08.....259	33645-25.....261	33661-25.....263	33676-25.....266
33496-00.....257	33623-02.....259	33645-32.....261	33661-30.....263	33677-05.....266
33496-01.....257	33623-03.....259	33647-06.....261	33664-04.....263	33677-10.....266
33496-12.....257	33623-04.....259	33647-09.....261	33664-06.....263	33677-16.....266
33497-00.....257	33623-05.....259	33647-14.....261	33664-08.....263	33677-25.....266
33498-00.....257	33623-06.....259	33647-16.....261	33664-10.....263	33678-24.....267
33498-01.....257	33623-07.....259	33647-19.....261	33664-12.....263	33679-13.....267
33498-12.....257	33623-08.....259	33647-25.....261	33665-04.....263	33680-22.....267
33500-01.....256	33625-02.....259	33647-32.....261	33665-06.....263	33682-01.....268
33500-02.....256	33625-03.....259	33649-09.....261	33665-08.....263	33682-02.....268
33500-03.....256	33625-04.....259	33649-14.....261	33665-10.....263	33682-22.....267
33500-03.....258	33625-05.....259	33649-16.....261	33665-12.....263	33683-01.....268
33509-05.....258	33625-06.....259	33649-19.....261	33665-24.....264	33683-02.....268
33509-08.....258	33625-07.....259	33649-25.....261	33665-26.....264	33683-03.....268
33510-12.....258	33625-08.....259	33649-32.....261	33665-55.....264	33683-04.....268
33510-14.....258	33626-25.....260	33650-04.....261	33665-90.....264	33683-05.....268
33510-16.....258	33626-35.....260	33650-06.....261	33666-22.....264	33683-06.....268
33600-02.....259	33627-04.....260	33650-08.....261	33668-03.....265	33684-00.....269
33600-03.....259	33627-06.....260	33650-10.....261	33668-05.....265	33686-25.....270
33600-04.....259	33628-03.....260	33650-13.....261	33668-06.....265	33687-75.....270
33600-05.....259	33628-05.....260	33650-16.....261	33668-08.....265	33688-45.....270
33600-06.....259	33630-06.....260	33650-18.....261	33668-09.....265	33689-90.....270
33600-08.....259	33630-08.....260	33650-20.....261	33668-13.....265	33690-22.....270
33600-09.....259	33630-10.....260	33650-25.....261	33668-16.....265	33691-34.....271
33600-10.....259	33630-12.....260	33650-30.....261	33668-19.....265	33692-26.....271
33602-04.....259	33630-15.....260	33650-38.....261	33669-05.....264	33693-32.....271
33602-06.....259	33630-20.....260	33650-44.....261	33669-10.....264	33693-33.....271
33602-08.....259	33630-25.....260	33650-50.....261	33669-15.....264	33693-34.....271
33602-10.....259	33630-30.....260	33651-04.....261	33670-05.....264	33694-01.....270
33602-12.....259	33631-10.....260	33651-06.....261	33670-06.....265	33694-03.....270
33602-14.....259	33631-12.....260	33651-08.....261	33670-09.....265	33695-40.....271
33602-16.....259	33631-15.....260	33651-10.....261	33670-10.....264	33696-75.....271
33604-04.....259	33631-20.....260	33651-13.....261	33670-13.....265	33698-98.....271
33604-06.....259	33631-25.....260	33651-16.....261	33670-15.....264	33699-00.....270
33604-08.....259	33631-30.....260	33651-18.....261	33670-16.....265	33699-17.....271
33604-10.....259	33632-06.....260	33651-20.....261	33670-19.....265	33700-01.....272
33604-12.....259	33632-08.....260	33651-25.....261	33670-25.....265	33700-01-01.....272
33604-14.....259	33632-10.....260	33651-30.....261	33670-32.....265	33700-02.....272
33604-16.....259	33632-12.....260	33651-38.....261	33671-06.....265	33700-03.....272
33605-04.....259	33632-15.....260	33651-44.....261	33671-09.....265	33700-04.....272
33605-06.....259	33632-20.....260	33651-50.....261	33671-13.....265	33700-05.....273
33605-08.....259	33632-25.....260	33652-02.....262	33671-16.....265	33700-06.....273
33605-10.....259	33632-30.....260	33652-03.....262	33671-19.....265	33700-07.....273
33605-12.....259	33633-06.....260	33652-04.....262	33671-25.....265	33700-08.....273
33605-14.....259	33633-08.....260	33652-06.....262	33671-32.....265	33702-15.....274
33605-16.....259	33633-10.....260	33652-08.....262	33672-06.....265	33703-15.....274
33610-04.....259	33633-12.....260	33652-10.....262	33672-09.....265	33704-01.....274
33610-06.....259	33633-15.....260	33652-12.....262	33672-13.....265	33704-02.....274
33610-08.....259	33633-20.....260	33652-15.....262	33672-16.....265	33705-05.....274
33610-10.....259	33633-25.....260	33654-02.....262	33672-19.....265	33705-10.....274
33610-12.....259	33633-30.....260	33654-03.....262	33672-25.....265	33705-15.....274
33610-14.....259	33634-06.....260	33654-04.....262	33672-32.....265	33705-20.....274
33611-04.....259	33634-08.....260	33654-06.....262	33673-06.....265	33705-25.....274
33611-06.....259	33634-10.....260	33654-08.....262	33673-09.....265	33706-18.....274
33611-08.....259	33634-12.....260	33654-10.....262	33673-13.....265	33707-17.....275
33611-10.....259	33634-15.....260	33654-12.....262	33673-16.....265	33708-19.....275
33611-12.....259	33634-20.....260	33654-15.....262	33673-19.....265	33709-21.....275
33611-14.....259	33634-25.....260	33656-28.....262	33673-25.....265	33710-19.....275
33620-02.....259	33634-30.....260	33657-28.....262	33673-32.....265	33711-16.....276
33620-03.....259	33644-06.....261	33658-28.....262	33675-06.....265	33711-18.....275
33620-04.....259	33644-09.....261	33659-28.....262	33675-09.....265	33711-20.....275
33620-05.....259	33644-13.....261	33660-07.....263	33675-13.....265	33711-21.....275
33620-06.....259	33644-16.....261	33660-10.....263	33675-16.....265	33712-16.....276

33713-16.....276	33803-05.....284	34101-01.....295	34320-10.....302	34402-22.....306
33713-17.....276	33803-07.....284	34101-02.....295	34320-15.....302	34402-23.....306
33714-15.....276	33803-43.....285	34101-03.....295	34320-20.....302	34402-24.....306
33715-20.....276	33804-15.....285	34101-04.....295	34320-25.....302	34402-25.....306
33716-18.....276	33805-22.....285	34101-05.....295	34320-27.....302	34402-28.....306
33717-19-01.....277	33805-33.....285	34101-06.....295	34320-30.....302	34402-30.....306
33717-19-02.....277	33807-24.....285	34101-07.....295	34320-32.....302	34403-08.....306
33718-16.....277	33809-22.....285	34105-01.....296	34320-35.....302	34403-10.....306
33719-17.....277	33810-24.....286	34110-00.....296	34320-40.....302	34403-11.....306
33720-19.....277	33811-06.....286	34112-00.....296	34320-45.....302	34403-12.....306
33720-21.....277	33811-08.....286	34112-01.....296	34320-50.....302	34403-13.....306
33721-17.....278	33812-16.....286/1	34112-02.....296	34320-60.....302	34403-14.....306
33723-17.....278	33813-12.....286/1	34114-39.....296	34320-70.....302	34403-15.....306
33725-17.....278	33814-44.....286/2	34116-30.....296	34321-10.....302	34403-16.....306
33727-17.....278	33814-65.....286/2	34118-31.....296	34321-15.....302	34403-17.....306
33728-24.....278	33823-26.....288	34120-23.....296	34321-20.....302	34403-18.....306
33729-01.....278	33825-26.....288	34161-13.....297	34321-25.....302	34403-19.....306
33729-02.....278	33826-00.....289	34162-13.....297	34321-27.....302	34403-20.....306
33729-03.....278	33826-01.....289	34172-00.....297	34321-30.....302	34403-22.....306
33729-04.....278	33826-02.....289	34172-01.....297	34321-32.....302	34403-23.....306
33729-05.....278	33826-03.....289	34175-00.....297	34321-35.....302	34403-24.....306
33729-06.....278	33827-17.....289	34175-01.....297	34321-40.....302	34403-25.....306
33729-07.....278	33828-21.....290	34210-20.....298	34321-45.....302	34403-28.....306
33729-24.....278	33829-25.....290	34212-25.....298	34321-50.....302	34403-30.....306
33731-22.....279	33830-23.....290	34212-30.....298	34321-60.....302	34404-08.....306
33733-22.....279	33831-16.....291	34212-35.....298	34321-65.....302	34404-09.....306
33740-19.....280	33832-01.....291	34212-40.....298	34321-70.....302	34404-10.....306
33741-18.....280	33832-02.....291	34214-05.....298	34321-80.....302	34404-11.....306
33742-18.....280	33832-03.....291	34214-08.....298	34321-90.....302	34404-12.....306
33743-18.....280	33832-04.....291	34214-10.....298	34322-00.....302	34404-13.....306
33745-19.....280	33832-05.....291	34214-12.....298	34322-11.....302	34404-14.....306
33746-19.....280	33833-16.....291	34214-16.....298	34322-15.....302	34404-15.....306
33747-18.....280	33910-17.....292	34216-10.....298	34322-20.....302	34404-16.....306
33748-20.....280	33911-17.....292	34216-15.....298	34322-25.....302	34404-17.....306
33749-10.....280	33913-17.....292	34216-20.....298	34322-27.....302	34404-18.....306
33749-13.....280	33921-22.....292	34220-24.....298	34322-32.....302	34404-19.....306
33749-19.....280	33923-22.....292	34222-25.....298	34322-35.....302	34404-20.....306
33754-17.....282	33950-01.....292	34222-30.....298	34322-45.....302	34404-22.....306
33755-17.....282	33950-02.....292	34222-35.....298	34392-14.....304	34404-23.....306
33756-17.....282	33950-03.....292	34230-28.....298	34393-18.....304	34404-24.....306
33757-17.....282	33950-04.....292	34231-15.....298	34393-21.....304	34404-25.....306
33758-01.....281	33950-05.....292	34232-00.....298	34394-14.....304	34404-28.....306
33758-02.....281	33960-15.....292	34240-27.....299	34401-08.....306	34404-30.....306
33758-04.....280	33960-25.....292	34241-00.....299	34401-10.....306	34405-08.....306
33758-06.....280	33960-45.....292	34242-09.....299	34401-11.....306	34405-09.....306
33758-08.....280	33960-55.....292	34242-14.....299	34401-12.....306	34405-10.....306
33759-06.....282	33961-15.....292	34242-16.....299	34401-13.....306	34405-11.....306
33759-12.....282	33962-16.....292	34242-22.....299	34401-14.....306	34405-12.....306
33759-19.....282	33963-12.....293	34243-02.....299	34401-15.....306	34405-13.....306
33759-25.....282	33964-15.....293	34244-10.....299	34401-16.....306	34405-14.....306
33760-01.....282	33964-19.....293	34244-14.....299	34401-17.....306	34405-15.....306
33760-02.....282	33964-24.....293	34244-16.....299	34401-18.....306	34405-16.....306
33760-03.....282	33965-15.....293	34244-17.....299	34401-20.....306	34405-17.....306
33761-21.....282	33965-19.....293	34246-00.....299	34401-22.....306	34405-18.....306
33763-01.....282	33965-24.....293	34248-00.....299	34401-23.....306	34405-19.....306
33763-02.....282	33966-11.....293	34250-00.....299	34401-24.....306	34405-20.....306
33763-03.....282	33966-15.....293	34252-00.....299	34401-25.....306	34405-22.....306
33763-04.....282	33967-15.....293	34270-00.....299	34401-28.....306	34405-23.....306
33765-17.....283	33967-20.....294	34270-01.....299	34401-30.....306	34405-24.....306
33767-19.....283	33968-30.....294	34280-00.....300	34402-08.....306	34405-25.....306
33769-30.....283	33968-60.....294	34290-00.....300	34402-10.....306	34405-28.....306
33771-71.....283	33969-18.....294	34295-00.....300	34402-11.....306	34405-30.....306
33771-73.....283	33969-23.....294	34296-00.....300	34402-12.....306	34406-08.....306
33801-08.....284	33970-01.....294	34296-05.....300	34402-13.....306	34406-09.....306
33801-12.....284	33970-02.....294	34296-10.....300	34402-14.....306	34406-10.....306
33801-18.....284	33970-03.....294	34296-15.....300	34402-15.....306	34406-11.....306
33801-43.....284	33971-24.....294	34296-20.....300	34402-16.....306	34406-12.....306
33801-70.....284	33972-22.....294	34296-25.....301	34402-17.....306	34406-13.....306
33802-01.....284	33973-27.....294	34296-30.....301	34402-18.....306	34406-14.....306
33802-02.....284	33975-30.....294	34296-35.....301	34402-19.....306	34406-15.....306
33802-14.....284	33977-28.....294	34296-40.....301	34402-20.....306	34406-16.....306

34432-14.....308	34438-12.....308	34444-24.....309	34480-03.....311	34555-18.....319
34432-16.....308	34438-14.....308	34444-25.....309	34492-01.....311	34555-20.....319
34432-18.....308	34438-16.....308	34444-28.....309	34492-02.....311	34556-18.....319
34432-20.....308	34438-18.....308	34444-30.....309	34492-03.....311	34558-32.....320
34432-22.....308	34438-20.....308	34444-32.....309	34502-16.....312	34559-47.....320
34432-23.....308	34438-24.....308	34444-35.....309	34502-21.....312	34560-57.....320
34432-24.....308	34438-25.....308	34445-12.....309	34514-18.....312	34570-01.....321
34432-26.....308	34438-28.....308	34445-14.....309	34514-27.....312	34570-02.....321
34432-28.....308	34438-30.....308	34445-16.....309	34515-01.....313	34573-35.....321
34432-30.....308	34438-32.....308	34445-18.....309	34515-02.....313	34583-60.....321
34433-08.....308	34438-35.....308	34445-20.....309	34515-09.....312	34584-60.....321
34433-10.....308	34439-12.....308	34445-24.....309	34515-10.....312	34585-60.....321
34433-12.....308	34439-14.....308	34445-25.....309	34515-11.....312	34588-01.....321
34433-14.....308	34439-16.....308	34445-28.....309	34515-12.....312	34588-02.....321
34433-16.....308	34439-18.....308	34445-30.....309	34515-13.....312	34588-03.....321
34433-18.....308	34439-20.....308	34445-32.....309	34515-15.....312	34590-00.....322
34433-20.....308	34439-24.....308	34445-35.....309	34515-20.....312	34590-01.....322
34433-22.....308	34439-25.....308	34446-12.....309	34518-01.....312	34590-02.....322
34433-23.....308	34439-28.....308	34446-14.....309	34518-02.....312	34596-29.....322
34433-24.....308	34439-30.....308	34446-16.....309	34518-03.....312	34596-37.....322
34433-26.....308	34439-32.....308	34446-18.....309	34519-01.....313	34596-42.....322
34433-28.....308	34439-35.....308	34446-20.....309	34519-02.....313	34596-49.....322
34433-30.....308	34440-12.....308	34446-24.....309	34520-02.....314	34597-06.....322
34434-08.....308	34440-14.....308	34446-25.....309	34520-03.....314	34597-07.....322
34434-10.....308	34440-16.....308	34446-28.....309	34520-04.....314	34597-08.....322
34434-12.....308	34440-18.....308	34446-30.....309	34520-05.....314	34597-09.....322
34434-14.....308	34440-20.....308	34446-32.....309	34520-06.....314	34597-10.....322
34434-16.....308	34440-24.....308	34446-35.....309	34520-07.....314	34597-11.....322
34434-18.....308	34440-25.....308	34447-12.....309	34520-08.....314	34597-12.....322
34434-20.....308	34440-28.....308	34447-14.....309	34520-09.....314	34597-13.....322
34434-22.....308	34440-30.....308	34447-16.....309	34520-10.....314	34597-14.....322
34434-23.....308	34440-32.....308	34447-18.....309	34520-12.....314	34597-15.....322
34434-24.....308	34440-35.....308	34447-20.....309	34520-15.....314	34597-16.....322
34434-26.....308	34441-12.....308	34447-24.....309	34528-01.....315	34597-17.....322
34434-28.....308	34441-14.....308	34447-25.....309	34528-02.....315	34597-18.....322
34434-30.....308	34441-16.....308	34447-28.....309	34528-03.....315	34597-19.....322
34435-08.....308	34441-18.....308	34447-30.....309	34530-28.....315	34597-20.....322
34435-10.....308	34441-20.....308	34447-32.....309	34531-21.....315	34612-00.....322
34435-12.....308	34441-24.....308	34447-35.....309	34533-17.....316	34613-00.....322
34435-14.....308	34441-25.....308	34450-08.....310	34534-15.....316	34615-00.....322
34435-16.....308	34441-28.....308	34450-10.....310	34534-18.....316	34617-00.....322
34435-18.....308	34441-30.....308	34450-12.....310	34535-16.....316	34620-25.....323
34435-20.....308	34441-32.....308	34450-14.....310	34536-14.....316	34624-01.....323
34435-22.....308	34441-35.....308	34450-15.....310	34537-19.....316	34624-02.....323
34435-23.....308	34442-12.....309	34450-18.....310	34538-01.....316	34624-03.....323
34435-24.....308	34442-14.....309	34450-20.....310	34538-02.....316	34624-04.....323
34435-26.....308	34442-16.....309	34450-22.....310	34538-03.....316	34628-01.....323
34435-28.....308	34442-18.....309	34450-25.....310	34539-01.....316	34628-02.....323
34435-30.....308	34442-20.....309	34450-30.....310	34539-02.....316	34628-15.....323
34436-12.....308	34442-24.....309	34460-08.....310	34539-03.....316	34628-25.....323
34436-14.....308	34442-25.....309	34460-10.....310	34540-01.....317	34628-35.....323
34436-16.....308	34442-28.....309	34460-12.....310	34540-02.....317	34629-01.....323
34436-18.....308	34442-30.....309	34460-14.....310	34540-16.....317	34632-25.....324
34436-20.....308	34442-32.....309	34460-15.....310	34540-18.....317	34634-25.....324
34436-24.....308	34442-35.....309	34460-16.....310	34541-23.....317	34634-35.....324
34436-25.....308	34443-12.....309	34460-20.....310	34542-15.....317	34637-23.....325
34436-28.....308	34443-14.....309	34460-22.....310	34543-23.....317	34639-22.....325
34436-30.....308	34443-16.....309	34460-25.....310	34544-18.....317	34640-18.....325
34436-32.....308	34443-18.....309	34460-30.....310	34545-22.....318	41011-15.....326
34436-35.....308	34443-20.....309	34470-08.....310	34546-16.....318	41011-19.....326
34437-12.....308	34443-24.....309	34470-10.....310	34546-18.....318	41015-23.....326
34437-14.....308	34443-25.....309	34470-12.....310	34548-18.....318	41015-26.....326
34437-16.....308	34443-28.....309	34470-14.....310	34549-14.....318	41017-23.....326
34437-18.....308	34443-30.....309	34470-15.....310	34550-13.....318	41017-26.....326
34437-20.....308	34443-32.....309	34470-16.....310	34550-18.....318	41019-14.....326
34437-24.....308	34443-35.....309	34470-20.....310	34551-17.....318	41020-00.....326
34437-25.....308	34444-12.....309	34470-22.....310	34552-16.....319	41025-01.....327
34437-28.....308	34444-14.....309	34470-25.....310	34554-15.....319	41025-02.....327
34437-30.....308	34444-16.....309	34470-30.....310	34554-18.....319	41026-35.....327
34437-32.....308	34444-18.....309	34480-01.....311	34554-20.....319	41026-50.....327
34437-35.....308	34444-20.....309	34480-02.....311	34555-15.....319	41027-00.....327

41028-00.....327	41244-19.....336	41306-07.....337/1	41512-03.....344	41604-58T.....349
41051-20.....328	41245-19.....336	41306-09.....337/1	41512-04.....344	41604-62.....349
41052-20.....328	41250-11.....336	41306-12.....337/1	41512-05.....344	41604-62T.....349
41053-20.....328	41250-15.....336	41307-00.....338	41513-01.....344	41604-79.....349
41054-20.....328	41250-18.....336	41307-03.....338	41513-02.....344	41604-79T.....349
41056-18.....328	41253-07.....336	41307-04.....338	41513-03.....344	41604-87.....349
41058-18.....328	41253-11.....336	41307-05.....338	41513-04.....344	41604-87T.....349
41061-16.....329	41253-15.....336	41307-06.....338	41513-05.....344	41605-10.....350
41064-16.....329	41253-18.....336	41401-16.....339	41514-01.....344	41605-10T.....350
41068-20.....329	41254-06.....337	41405-17.....339	41514-02.....344	41605-12.....350
41069-20.....329	41254-10.....337	41405-27.....339	41514-03.....344	41605-12T.....350
41070-29.....329	41254-13.....337	41406-01.....339	41514-04.....344	41605-13.....350
41074-23.....329/1	41254-16.....337	41406-02.....339	41514-05.....344	41605-13T.....350
41075-24.....329/1	41254-19.....337	41420-01.....340	41515-01.....344	41606-62.....350
41076-03.....329/1	41254-25.....337	41420-02.....340	41515-02.....344	41606-62T.....350
41076-04.....329/1	41254-32.....337	41420-03.....340	41515-03.....344	41606-65.....350
41076-05.....329/1	41254-38.....337	41421-01.....340	41515-04.....344	41606-65T.....350
41076-07.....329/1	41290-21.....337	41421-02.....340	41515-05.....344	41606-78.....350
41078-23.....329/2	41294-40.....337	41421-03.....340	41520-03.....344/1	41606-78T.....350
41079-21.....329/2	41295-06.....337	41422-01.....340	41520-05.....344/1	41606-84.....350
41080-19.....330	41295-07.....337	41422-02.....340	41522-03.....344/1	41606-84T.....350
41081-19.....330	41295-08.....337	41422-03.....340	41522-05.....344/1	41607-56.....350
41083-19.....330	41295-09.....337	41430-01.....340	41524-03.....344/1	41607-56T.....350
41085-20.....330	41295-10.....337	41430-02.....340	41524-05.....344/1	41607-57.....350
41090-33.....330	41295-11.....337	41430-03.....340	41526-03.....344/1	41607-57T.....350
41091-31.....330	41295-12.....337	41431-01.....340	41526-05.....344/1	41607-58.....350
41091-41.....330	41297-06.....337	41431-02.....340	41527-03.....344/1	41607-58T.....350
41092-30.....332	41297-07.....337	41431-03.....340	41527-05.....344/1	41607-59.....350
41092-40.....332	41297-08.....337	41432-01.....340	41529-03.....344/1	41607-59T.....350
41092-50.....332	41297-09.....337	41432-02.....340	41529-05.....344/1	41607-60.....350
41092-60.....332	41297-10.....337	41432-03.....340	41540-02.....344/2	41607-60T.....350
41092-70.....332	41297-11.....337	41440-01.....340	41540-03.....344/2	41607-72.....350
41094-00.....332	41297-12.....337	41440-02.....340	41540-04.....344/2	41607-72T.....350
41096-21.....332	41298-12.....337	41440-03.....340	41540-05.....344/2	41607-73.....350
41097-22.....331	41299-03.....336	41441-01.....340	41542-02.....344/2	41607-73T.....350
41141-25.....332	41299-05.....336	41441-02.....340	41542-03.....344/2	41607-82.....350
41143-21.....332	41299-07.....336	41441-03.....340	41542-04.....344/2	41607-82T.....350
41145-21.....332	41300-02.....337/1	41442-01.....340	41542-05.....344/2	41608-57.....350
41146-18.....332	41300-03.....337/1	41442-02.....340	41600-62.....349	41608-57T.....350
41146-24.....332	41300-04.....337/1	41442-03.....340	41600-62T.....349	41608-80.....350
41147-21.....332	41300-05.....337/1	41443-26.....341	41600-70.....349	41608-80T.....350
41149-22.....332	41301-15.....337/1	41445-25.....341	41600-70T.....349	41609-70.....350
41151-24.....332	41301-20.....337/1	41447-27.....341	41600-78.....349	41609-70T.....350
41155-20.....333	41301-25.....337/1	41448-02.....342	41600-78T.....349	41610-61.....351
41156-18.....333	41301-35.....337/1	41448-03.....342	41600-92.....349	41610-61T.....351
41158-01.....333	41302-01.....337/1	41448-04.....342	41600-92T.....349	41610-68.....351
41158-02.....333	41302-02.....337/1	41449-01.....342	41601-10.....349	41610-68T.....351
41158-03.....333	41303-09.....337/2	41449-02.....342	41601-10T.....349	41610-70.....351
41161-01.....333	41303-12.....337/2	41449-03.....342	41601-11.....349	41610-70T.....351
41161-02.....333	41303-15.....337/2	41451-01.....343	41601-11T.....349	41611-74.....351
41161-03.....333	41303-18.....337/2	41451-02.....343	41601-13.....349	41611-74T.....351
41161-04.....333	41303-25.....337/2	41451-03.....343	41601-13T.....349	41611-87.....351
41161-05.....333	41303-30.....337/2	41452-01.....343	41602-60.....349	41611-87T.....351
41210-23.....334	41303-45.....337/2	41452-02.....343	41602-60T.....349	41611-92.....351
41211-23.....334	41304-06.....338	41452-03.....343	41602-68.....349	41611-92T.....351
41213-23.....334	41304-08.....338	41453-01.....343	41602-68T.....349	41612-07.....351
41221-00.....334	41304-10.....338	41453-02.....343	41602-75.....349	41612-07T.....351
41222-00.....334	41305-05.....338	41453-03.....343	41602-75T.....349	41612-09.....351
41223-00.....334	41305-06.....338	41458-20.....343	41602-87.....349	41612-09T.....351
41224-00.....334	41305-07.....338	41510-01.....344	41602-87T.....349	41612-11.....351
41230-19.....335	41305-08.....338	41510-02.....344	41603-55.....349	41612-11T.....351
41231-19.....335	41305-09.....338	41510-03.....344	41603-55T.....349	41612-12.....351
41232-19.....335	41305-10.....338	41510-04.....344	41603-61.....349	41612-12T.....351
41233-19.....335	41305-12.....338	41510-05.....344	41603-61T.....349	41612-62.....351
41234-19.....335	41305-14.....338	41511-01.....344	41603-65.....349	41612-62T.....351
41236-19.....335	41305-15.....338	41511-02.....344	41603-65T.....349	41613-74.....352
41237-19.....335	41305-18.....338	41511-03.....344	41603-74.....349	41613-74T.....352
41238-19.....335	41305-20.....338	41511-04.....344	41603-74T.....349	41613-84.....352
41239-19.....335	41305-25.....338	41511-05.....344	41604-54.....349	41613-84T.....352
41242-19.....336	41305-30.....338	41512-01.....344	41604-54T.....349	41613-96.....352
41243-19.....336	41306-05.....337/1	41512-02.....344	41604-58.....349	41613-96T.....352

41614-58.....352	41627-33T.....355	41647-11.....358	41826-26...368/2 - 368/4	43228-12.....373
41614-58T.....352	41627-40.....355	41648-07.....358	41830-30...368 - 368/4	43231-12.....373
41614-65.....352	41627-40T.....355	41648-09.....358	41832-32.....368/4	43233-13.....373
41614-65T.....352	41628-33.....355	41648-11.....358	41842-42...368 - 368/1	43240-01.....373
41614-72.....352	41628-33T.....355	41649-07.....359	41842-44.....368/1	43240-02.....373
41614-72T.....352	41628-40.....355	41649-09.....359	41842-46.....368/1	43240-03.....373
41615-49.....352	41628-40T.....355	41649-11.....359	41843-50...368 - 368/1	43240-04.....373
41615-49T.....352	41628-46.....355	41650-07.....359	41850-41...368 - 368/1	43245-12.....373
41615-50.....352	41628-46T.....355	41650-09.....359	41860-14.....369	43251-12.....373
41615-50T.....352	41629-32.....355	41650-11.....359	41860-17.....369	43253-12.....373
41615-51.....352	41629-32T.....355	41651-07.....359	41860-20.....369	43256-12.....373
41615-51T.....352	41629-38.....355	41651-09.....359	41870-08.....369	43258-12.....373
41616-79.....353	41629-38T.....355	41651-11.....359	41870-11.....369	43262-12.....373
41616-79T.....353	41630-36.....355	41652-07.....359	41870-14.....369	43271-11.....373
41616-91.....353	41630-36T.....355	41652-09.....359	41870-17.....369	43273-13.....373
41616-91T.....353	41630-38.....355	41652-11.....359	41880-01...368 - 369	43304-12.....374
41617-10.....353	41630-38T.....355	41653-18.....360	41880-02...368 - 369	43305-12.....374
41617-10T.....353	41631-36.....355	41654-18.....360	41880-03.....369	43308-12.....374
41617-65.....353	41631-36T.....355	41655-18.....360	43101-03.....370	43309-12.....374
41617-65T.....353	41631-40.....355	41656-18.....360	43101-04.....370	43310-13.....374
41617-72.....353	41631-40T.....355	41657-17.....360	43104-07.....370	43311-13.....374
41617-72T.....353	41631-44.....355	41657-21.....360	43105-06.....370	43314-13.....374
41617-78.....353	41631-44T.....355	41657-23.....360	43105-05.....370	43321-12.....374
41617-78T.....353	41632-36.....355	41658-17.....360	43107-08.....370	43325-13.....374
41618-55.....353	41632-36T.....355	41658-21.....360	43109-07.....370	43327-12.....374
41618-55T.....353	41633-35.....355	41658-23.....360	43109-09.....370	43330-13.....374
41618-56.....353	41633-35T.....355	41659-17.....360	43110-08.....370	43331-11.....374
41618-56T.....353	41633-40.....355	41659-21.....360	43111-07.....370	43332-12.....374
41618-57.....353	41633-40T.....355	41659-23.....360	43113-07.....370	43334-12.....374
41618-57T.....353	41634-35.....355	41660-17.....360	43115-05.....370	43336-12.....374
41618-79.....353	41634-35T.....355	41660-21.....360	43121-07.....370	43340-13.....374
41618-79T.....353	41634-60.....355	41660-23.....360	43123-07.....370	43342-12.....374
41618-88.....353	41634-60T.....355	41661-40.....361	43125-05.....370	43351-01.....375
41618-88T.....353	41634-70.....355	41661-50.....361	43125-07.....370	43351-02.....375
41619-00.....353	41634-70T.....355	41662-50.....361	43127-08.....370	43351-03.....375
41619-00T.....353	41635-57.....355	41663-01.....361	43128-08.....370	43353-13.....375
41620-58.....354	41635-57T.....355	41663-02.....361	43129-07.....371	43355-13.....375
41620-58T.....354	41636-45.....355	41664-10.....362	43130-07.....371	43357-13.....375
41620-59.....354	41636-45T.....355	41664-14.....362	43132-08.....371	43363-01.....375
41620-59T.....354	41637-33.....356	41665-10.....362	43133-08.....371	43363-02.....375
41620-60.....354	41637-33T.....356	41665-14.....362	43135-07.....371	43370-12.....375
41620-60T.....354	41637-40.....356	41666-00.....362	43139-07.....371	43372-13.....375
41620-61.....354	41637-40T.....356	41667-30.....363	43140-08.....371	43373-13.....375
41620-61T.....354	41638-38.....356	41667-50.....363	43141-08.....371	43376-13.....375
41620-62.....354	41638-38T.....356	41668-50.....363	43150-11.....371	43377-13.....375
41620-62T.....354	41638-46.....356	41669-50.....363	43170-00.....371	43380-13.....375
41620-63.....354	41638-46T.....356	41670-50.....363	43170-01.....371	43381-13.....375
41620-63T.....354	41639-44.....356	41672-01.....364	43170-02.....371	43383-13.....375
41620-70.....354	41639-44T.....356	41672-02.....364	43170-03.....371	43386-13.....375
41620-70T.....354	41640-40.....356	41672-03.....364	43172-13.....371	43387-02.....376
41620-78.....354	41640-40T.....356	41672-04.....364	43180-01.....372	43388-02.....376
41620-78T.....354	41641-07.....357	41674-50.....365	43180-02.....372	43389-02.....376
41620-88.....354	41641-09.....357	41674-80.....365	43180-03.....372	43390-05.....376
41620-88T.....354	41641-11.....357	41675-50.....365	43181-01.....372	43391-13.....376
41621-58.....354	41642-07.....357	41675-80.....365	43181-02.....372	43402-05.....377
41621-58T.....354	41642-09.....357	41676-50.....365	43181-03.....372	43402-10.....377
41621-62.....354	41642-11.....357	41676-80.....365	43183-13.....372	43402-15.....377
41621-62T.....354	41643-07.....357	41677-50.....365	43185-13.....372	43402-18.....377
41622-58.....354	41643-09.....357	41677-80.....365	43187-13.....372	43402-20.....377
41622-58T.....354	41643-11.....357	41678-50.....365	43202-01.....372	43402-25.....377
41622-62.....354	41644-07.....357	41678-80.....365	43202-02.....372	43402-35.....377
41622-62T.....354	41644-09.....357	41679-25.....366	43202-03.....372	43402-40.....377
41623-56.....354	41644-11.....357	41680-00.....366	43210-01.....372	43402-45.....377
41623-56T.....354	41645-07.....358	41801-01.....368/2	43210-02.....372	43404-10.....377
41624-56.....354	41645-09.....358	41802-00.....368	43210-03.....372	43404-20.....377
41624-56T.....354	41645-11.....358	41802-02.....368/2	43213-12.....372	43404-24.....377
41625-56.....354	41646-07.....358	41803-01.....368/2	43214-04.....372	43404-30.....377
41625-56T.....354	41646-09.....358	41807-00.....368/3	43214-08.....372	43404-35.....377
41626-56.....354	41646-11.....358	41810-10...368 - 368/3	43218-12.....373	43407-13.....377
41626-56T.....354	41647-07.....358	41821-21...368/3 - 368/4	43221-11.....373	43410-01.....377
41627-33.....355	41647-09.....358	41822-22...368/2 - 368/4	43226-12.....373	43410-02.....377

43412-01.....377	43830-10.....383	44150-01.....392	45014-45.....399	45097-02.....406
43412-02.....377	43831-10.....383	44150-03.....392	45014-55.....399	45097-03.....406
43414-02.....378	43833-10.....383	44150-05.....392	45014-65.....399	45097-10.....406
43420-01.....378	43840-10.....383	44150-10.....392	45014-75.....399	45097-15.....406
43420-02.....378	43841-10.....383	44150-15.....392	45015-00.....399	45098-01.....407
43420-03.....378	43843-10.....383	44151-05.....392	45015-45.....399	45098-02.....407
43424-13.....378	43850-08.....383	44151-10.....392	45015-55.....399	45098-05.....407
43441-01.....378	43851-08.....383	44151-15.....392	45015-65.....399	45098-10.....407
43441-02.....378	43852-08.....383	44164-10.....392	45015-75.....399	45098-20.....407
43443-13.....378	43853-08.....383	44166-07.....392	45018-00.....399	45098-50.....407
43445-13.....378	43855-07.....384	44181-10.....392	45018-50.....399	45099-01.....407
43447-13.....378	43857-07.....384	44190-08.....392	45018-60.....399	45099-02.....407
43449-01.....378	43861-07.....384	44202-08.....392	45018-70.....399	45099-05.....407
43449-02.....378	43863-07.....384	44210-10.....392	45018-80.....399	45099-10.....407
43461-13.....378	43865-07.....384	44220-10.....392	45020-01.....400	45099-20.....407
43462-13.....378	43869-07.....384	44240-09.....393	45020-02.....400	45099-50.....407
43467-13.....378	43881-07.....384	44242-09.....393	45020-03.....400	45109-00.....407
43482-20.....378	43883-07.....384	44246-09.....393	45020-04.....400	45110-00.....407
43485-13.....378	43885-07.....384	44254-09.....393	45030-04.....401	45110-01.....407
43487-14.....378	43887-07.....384	44256-09.....393	45030-06.....401	45110-02.....407
43501-06.....379	43891-09.....385	44258-09.....393	45030-07.....401	45110-03.....407
43501-10.....379	43902-09.....385	44265-10.....393	45030-08.....401	45110-04.....407
43501-12.....379	43903-09.....385	44267-10.....393	45030-10.....401	45110-05.....407
43511-13.....379	43907-10.....385	44274-11.....393	45036-03.....402	45111-00.....407
43513-14.....379	43909-10.....385	44300-00.....394	45036-06.....402	45112-00.....407
43515-14.....379	43914-10.....385	44301-00.....394	45036-07.....402	45112-01.....407
43517-09.....379	43916-10.....385	44310-00.....394	45036-08.....402	45112-02.....407
43521-12.....379	43920-11.....385	44311-00.....394	45036-09.....401	45112-03.....407
43523-12.....379	43924-11.....386	44320-00.....394	45036-10.....401	45112-04.....407
43524-10.....379	43926-11.....386	44330-00.....394	45060-01.....403	45112-05.....407
43525-05.....379	43940-05.....386	44340-00.....394	45060-02.....403	45114-00.....407
43525-07.....379	43940-08.....386	44350-00.....394	45060-03.....403	45115-00.....407
43525-10.....379	43942-05.....386	44370-00.....394/1	45060-04.....403	45115-01.....407
43526-12.....379	43942-08.....386	44371-00.....394/1	45060-05.....403	45115-02.....407
43542-12.....380	43944-07.....387	44372-00.....394/1	45061-00.....403	45115-03.....407
43544-12.....380	43946-07.....387	44373-00.....394/1	45070-01.....403	45115-04.....407
43546-13.....380	43948-10.....387	44374-00.....394/1	45070-02.....403	45115-05.....407
43548-13.....380	43950-10.....387	44380-00.....394/2	45070-03.....403	45116-00.....407
43583-07.....380	43952-10.....387	44390-00.....394/2	45070-04.....403	45117-00.....407
43589-13.....380	43953-10.....387	44404-00.....394/2	45070-05.....403	45117-01.....407
43593-09.....380	43955-10.....387	44406-00.....394/2	45070-06.....403	45117-02.....407
43602-01.....381	43956-10.....387	44408-00.....395	45071-00.....403	45117-03.....407
43602-02.....381	44015-20.....389	44420-09.....395	45072-01.....404	45117-04.....407
43602-03.....381	44015-27.....389	44422-09.....395	45073-01.....404	45117-05.....407
43605-12.....381	44017-08.....389	44424-08.....395	45073-02.....404	45133-01.....408
43605-34.....381	44046-11.....389	44425-10.....395	45073-03.....404	45133-02.....408
43605-56.....381	44050-11.....389	44426-09.....395	45073-04.....404	45133-03.....408
43608-12.....381	44052-11.....389	44428-09.....395	45073-05.....404	45133-04.....408
43609-14.....381	44054-09.....389	45009-00.....399	45073-06.....404	45133-05.....408
43610-01.....381	44066-09.....390	45009-02.....399	45074-01.....404	45150-18.....408
43610-02.....381	44067-09.....390	45009-03.....399	45075-00.....404	45151-16.....408
43613-00.....381	44068-09.....390	45009-04.....399	45076-01.....404	45152-01.....408
43614-00.....381	44069-09.....390	45010-00.....399	45080-00.....405	45152-02.....408
43614-01.....381	44074-10.....390	45010-20.....399	45090-00.....405	45153-16.....408
43614-12.....381	44076-05.....390	45010-30.....399	45090-02.....405	45160-15.....408
43614-23.....381	44076-10.....390	45010-45.....399	45090-03.....405	45162-18.....408
43614-34.....381	44078-05.....390	45010-55.....399	45090-04.....405	45164-17.....408
43614-45.....381	44078-10.....390	45010-65.....399	45090-05.....405	45165-17.....408
43614-56.....381	44101-07.....390	45010-75.....399	45090-06.....405	45171-12.....409
43614-67.....381	44103-09.....391	45011-00.....399	45090-08.....405	45180-01.....409
43614-78.....381	44106-10.....391	45011-03.....399	45091-00.....406	45180-02.....409
43802-07.....382	44109-10.....391	45011-04.....399	45091-01.....406	45180-03.....409
43803-07.....382	44111-10.....391	45011-05.....399	45091-02.....406	45181-13.....409
43804-07.....382	44114-10.....391	45011-07.....399	45091-03.....406	45184-16.....409
43805-07.....382	44115-10.....391	45011-08.....399	45091-04.....406	45185-15.....409
43810-10.....382	44117-10.....391	45012-00.....399	45091-15.....406	45190-01.....409
43811-10.....382	44119-10.....391	45012-40.....399	45091-17.....406	45190-02.....409
43813-10.....382	44121-10.....391	45012-55.....399	45091-22.....406	45192-01.....409
43820-10.....382	44125-06.....391	45012-65.....399	45096-50.....406	45192-02.....409
43821-10.....382	44127-06.....391	45012-75.....399	45096-75.....406	45192-03.....409
43823-10.....382	44129-07.....391	45014-00.....399	45097-01.....406	45192-04.....409

45192-05.....409	45390-35.....415	45743-10.....419	47191-01.....425	47332-30.....433
45192-06.....409	45390-50.....415	45745-03.....419	47191-02.....425	47332-40.....433
45193-01.....409	45391-35.....415	45745-06.....419	47191-03.....425	47338-20.....433
45193-02.....409	45392-35.....415	45745-10.....419	47191-04.....425	47338-25.....433
45193-03.....409	45393-50.....415	45747-03.....419	47192-16.....426	47338-30.....433
45194-01.....410	45394-50.....415	45747-06.....419	47195-01.....426	47339-20.....433
45194-02.....410	45400-01.....416	45747-10.....419	47195-02.....426	47339-25.....433
45194-03.....410	45400-02.....416	45751-16.....420	47197-01.....426	47339-30.....433
45194-04.....410	45400-03.....416	45753-16.....420	47197-02.....426	47340-15.....433
45201-11.....410	45401-25.....416	45755-16.....420	47223-01.....426	47340-18.....433
45201-13.....410	45402-10.....416	45757-16.....420	47223-02.....426	47340-20.....433
45203-11.....410	45403-13.....416	45760-01.....420	47223-03.....426	47342-25.....433
45206-14.....410	45404-13.....416	45760-02.....420	47223-04.....426	47342-30.....433
45206-16.....410	45410-01.....417	45762-01.....420	47223-05.....426	47342-40.....433
45208-14.....410	45411-01.....417	45762-02.....420	47224-01.....426	47343-00.....433/1
45220-16.....411	45412-01.....417	45766-35.....420	47224-02.....426	47343-15.....433/1
45222-17.....411	45413-01.....417	45766-40.....420	47224-03.....426	47343-17.....433/1
45225-02.....411	45414-01.....417	45766-45.....420	47224-04.....426	47343-20.....433/1
45243-14.....411	45701-01.....418	45766-50.....420	47224-05.....426	47343-25.....433/1
45245-12.....411	45701-02.....418	45802-16.....420	47235-05.....427	47343-30.....433/1
45246-12.....411	45703-15.....418	45803-16.....420	47235-07.....427	47344-15.....433/1
45246-14.....411	45704-15.....418	45805-16.....420	47235-09.....427	47344-17.....433/1
45251-10.....412	45705-15.....418	45807-20.....420	47235-11.....427	47344-20.....433/1
45253-11.....412	45706-35.....418	47050-01.....421	47237-01.....427	47344-25.....433/1
45255-08.....412	45709-10.....418	47050-02.....421	47237-02.....427	47344-30.....433/1
45257-08.....412	45709-14.....418	47050-03.....421	47237-03.....427	47345-15.....433/1
45261-08.....412	45709-16.....418	47050-04.....421	47239-01.....427	47347-20.....433/1
45261-14.....412	45709-20.....418	47050-05.....421	47239-02.....427	47350-26.....433/2
45261-16.....412	45709-26.....418	47050-06.....421	47240-19.....427	47351-26.....433/2
45263-08.....412	45709-28.....418	47050-07.....421	47242-00.....427	47352-24.....433/2
45263-14.....412	45709-30.....418	47060-01.....421	47242-01.....427	47355-03.....433/2
45265-08.....412	45710-15.....419	47060-02.....421	47251-21.....428	47370-16.....434
45267-20.....412	45711-15.....419	47060-03.....421	47255-01.....428	47371-16.....434
45267-25.....412	45713-15.....419	47102-01.....421	47255-02.....428	47372-16.....434
45267-30.....412	45715-17.....419	47102-02.....421	47256-20.....428	47373-16.....434
45269-30.....412	45720-03.....419	47102-03.....421	47303-03.....428	47374-16.....434
45271-08.....412	45720-06.....419	47103-01.....422	47303-04.....428	47375-16.....434
45273-08.....412	45720-10.....419	47103-02.....422	47303-05.....428	47375-19.....434
45275-08.....412	45722-03.....419	47103-03.....422	47303-06.....428	47376-16.....435
45310-40.....413	45722-06.....419	47112-01.....421	47304-01.....429	47379-16.....435
45312-55.....413	45722-10.....419	47112-02.....421	47304-02.....429	47380-15.....435
45313-55.....413	45722-12.....419	47112-03.....421	47304-03.....429	47382-15.....435
45315-55.....413	45722-15.....419	47113-03.....421	47304-04.....429	47384-15.....435
45317-55.....413	45722-20.....419	47116-13.....423	47305-01.....429	47385-15.....435
45320-70.....413	45722-25.....419	47118-13.....423	47305-02.....429	47386-01.....435
45321-70.....413	45724-03.....419	47120-35.....423	47305-03.....429	47386-02.....435
45322-70.....413	45724-06.....419	47120-50.....423	47311-10.....430	47387-01.....435
45350-40.....413	45724-10.....419	47120-75.....423	47311-25.....430	47387-02.....435
45350-70.....413	45724-12.....419	47120-90.....423	47311-30.....430	47390-03.....436
45352-40.....413	45724-15.....419	47124-35.....423	47315-00.....430	47390-04.....436
45353-60.....413	45724-20.....419	47124-50.....423	47316-00.....430	47390-05.....436
45355-60.....413	45724-25.....419	47124-75.....423	47316-16.....431	47392-03.....436
45357-40.....413	45725-05.....419	47124-90.....423	47317-00.....430	47392-04.....436
45359-40.....413	45725-10.....419	47139-12.....423	47317-11.....431	47392-05.....436
45360-35.....413	45730-03.....419	47139-14.....423	47317-65.....431	47410-04.....437
45362-45.....414	45730-06.....419	47139-16.....423	47317-70.....431	47410-05.....437
45363-45.....414	45730-10.....419	47139-18.....423	47317-90.....431	47410-16.....437
45365-45.....414	45732-03.....419	47151-15.....424	47318-11.....431	47411-16.....437
45367-50.....414	45732-06.....419	47151-18.....424	47318-65.....431	47413-19.....437
45369-50.....414	45732-10.....419	47154-20.....424	47318-70.....431	47415-18.....437
45370-50.....414	45733-05.....419	47155-20.....424	47318-90.....431	47417-19.....437
45371-40.....414	45733-10.....419	47158-20.....424	47319-35.....432	47419-19.....437
45373-30.....414	45735-05.....419	47159-20.....424	47319-45.....432	47420-01.....438
45375-60.....414	45735-10.....419	47161-16.....424	47323-19.....430	47420-02.....438
45377-60.....414	45736-15.....419	47161-20.....424	47325-19.....430	47420-03.....438
45381-30.....414	45737-15.....419	47167-18.....425	47331-20.....433	47420-04.....438
45383-30.....414	45741-03.....419	47169-18.....425	47331-25.....433	47420-20.....438
45385-01.....414	45741-06.....419	47171-14.....425	47331-30.....433	47421-21.....438
45385-02.....414	45741-10.....419	47173-14.....425	47331-40.....433	47421-23.....439
45387-01.....414	45743-03.....419	47181-18.....425	47332-20.....433	47422-22.....439
45387-02.....414	45743-06.....419	47185-18.....425	47332-25.....433	47423-22.....439

47424-16.....439	47522-09.....445	49107-19.....451	49360-10.....459	51111-23.....465
47425-19.....439	47523-01.....446	49108-15.....451	49400-01.....459	51131-22.....465
47426-22.....439	47523-02.....446	49109-19.....451	49501-22.....459	51133-23.....465
47428-21.....439	47526-16.....446	49110-19.....452	49501-23.....459	51134-21.....465
47430-22.....439	47527-16.....446	49111-15.....452	49501-24.....459	51135-01.....465
47450-04.....439	47529-16.....446	49115-01.....452	49503-22.....459	51135-02.....465
47451-04.....439	47532-19.....446	49115-02.....452	49503-23.....459	51139-25.....465
47454-04.....440	47533-19.....446	49117-11.....452	49503-24.....459	51143-24.....465
47454-07.....440	47534-19.....446	49119-14.....453	49605-07.....460	51151-19.....465
47454-09.....440	47535-01.....446	49230-11.....453	49605-10.....460	51165-22.....466
47454-12.....440	47535-02.....446	49231-12.....453	49605-11.....460	51167-22.....466
47455-06.....440	47540-16.....447	49231-14.....453	49605-12.....460	51168-23.....466
47458-04.....440	47541-14.....447	49231-16.....453	49605-14.....460	51169-23.....466
47458-07.....440	47542-12.....447	49235-19.....453	49605-16.....460	51170-24.....466
47458-09.....440	47551-16.....447	49250-16.....453	49610-12.....460	51171-22.....466
47458-12.....440	47551-16L.....447	49250-18.....453	49610-13.....460	51172-19.....466
47460-04.....440	47552-16.....447	49255-16.....453	49610-16.....460	51173-21.....466
47460-07.....440	47553-15.....447/1	49255-99.....453	49613-10.....461	51174-21.....466
47460-12.....440	47554-01.....447/1	49265-12.....454	49615-12.....461	51177-23.....466
47461-00.....440	47554-02.....447/1	49265-14.....454	49620-15.....461	51178-21.....466
47463-10.....440	47554-03.....447/1	49267-12.....454	49623-16.....461	51179-17.....466
47463-12.....440	47555-08.....447/1	49270-16.....454	49627-01.....461	51181-19.....467
47463-14.....440	47556-16.....447/1	49270-19.....454	49630-02.....461	51183-19.....467
47470-04.....441	47557-17.....447/1	49272-13.....454	49635-18.....462	51185-19.....467
47470-05.....441	47558-15.....448	49274-09.....454	49640-05.....462	51187-19.....467
47470-06.....441	47559-20.....448	49274-11.....454	49640-07.....462	51191-19.....467
47470-07.....441	47560-18.....448	49274-13.....454	49640-09.....462	51193-19.....467
47471-02.....441	47562-18.....448	49274-15.....454	49650-06.....462	51202-19.....467
47471-03.....441	47563-22.....448	49287-02.....455	49650-07.....462	51203-19.....467
47471-04.....441	47564-16.....448	49287-03.....455	49650-09.....462	51205-18.....467
47471-05.....441	47565-10.....448	49287-04.....455	49650-11.....462	51205-23.....467
47471-06.....441	47566-12.....448	49287-05.....455	49660-18.....463	51207-21.....467
47471-07.....441	47571-23.....449	49288-02.....455	49665-24.....463	51209-20.....467
47471-08.....441	47572-23.....449	49288-03.....455	49670-19.....463	51210-20.....468
47471-10.....441	47573-23.....449	49288-04.....455	49670-23.....463	51211-21.....468
47471-12.....441	47575-23.....449	49288-05.....455	49671-01.....463/1	51213-21.....468
47472-10.....441	47601-21.....449	49310-00.....455	49671-01CL.....463/1	51219-22.....468
47472-12.....441	47607-01.....449	49310-01.....455	49671-02.....463/1	51250-28.....468
47472-14.....441	47607-02.....449	49310-02.....455	49671-02CL.....463/1	51252-28.....468
47472-16.....441	47607-03.....449	49310-03.....455	49673-01.....463/2	51256-28.....468
47473-01.....442	47607-04.....449	49310-04.....455	49673-02.....463/2	51257-40.....468
47473-02.....442	47607-05.....449	49310-05.....455	49673-03.....463/2	51257-50.....468
47473-03.....442	47607-06.....449	49310-10.....455	49673-04.....463/2	51259-03.....468
47474-01.....442	47620-00.....450	49310-12.....455	49675-18.....463/3	51259-04.....468
47474-02.....442	47620-01.....450	49315-00.....456	49680-10.....463/3	51259-05.....468
47474-03.....442	47620-02.....450	49315-01.....456	49680-20.....463/3	51260-00.....469
47481-05.....442/1	47620-03.....450	49315-02.....456	49685-21.....463/3	51270-00.....470
47482-05.....442/1	47620-04.....450	49315-03.....456	49691-15.....463/3	51270-01.....470
47484-04.....442/1	47620-05.....450	49315-10.....456	49692-15.....463/3	51270-02.....470
47484-06.....442/1	47620-06.....450	49317-00.....456	49694-25.....463/4	51270-03.....470
47484-08.....442/1	47630-00.....450	49317-01.....456	49694-25CL.....463/4	51270-04.....470
47486-16.....442/1	47630-01.....450	49317-02.....456	49695-01.....463/5	51290-02.....470
47487-16.....442/1	47630-02.....450	49317-03.....456	49695-02.....463/5	51290-05.....470
47489-16.....442/1	47630-03.....450	49317-10.....456	49696-18.....463/6	51290-10.....470
47502-16.....443	47630-04.....450	49320-00.....457	49700-01.....464	51290-20.....470
47504-18.....443	47636-01.....450	49320-01.....457	49700-02.....464	51291-00.....470
47507-17.....443	47636-02.....450	49320-02.....457	49705-08.....464/1	51292-00.....470
47507-19.....443	47636-03.....450	49320-03.....457	49705-12.....464/1	51293-00.....470
47511-21.....443	47636-04.....450	49320-10.....457	49705-16.....464/1	51293-45.....470
47513-21.....443	47641-01.....450	49320-20.....457	49705-20.....464/1	51293-90.....470
47514-16.....443	47641-02.....450	49340-00.....457	49710-04.....464/2	53101-22.....471
47516-16.....443	47641-03.....450	49342-01.....458	49710-06.....464/2	53102-20.....471
47518-21.....444	47642-01.....450	49342-02.....458	49710-08.....464/2	53103-22.....471
47520-21.....444	47642-02.....450	49342-03.....458	49711-04.....464/2	53111-18.....471
47521-01.....444	47642-03.....450	49342-04.....458	49711-06.....464/2	53115-01.....471
47521-02.....444	49102-16.....451	49342-05.....458	49713-06.....464/2	53115-02.....471
47521-03.....444	49103-17.....451	49345-01.....458	49713-08.....464/2	53115-03.....471
47522-01.....445	49104-15.....451	49345-02.....458	51103-18.....465	53115-04.....471
47522-04.....445	49105-16.....451	49345-03.....458	51103-20.....465	53121-24.....471
47522-05.....445	49106-01.....451	49345-04.....458	51103-22.....465	53130-00.....472
47522-07.....445	49106-02.....451	49345-05.....458	51109-24.....465	53131-20.....472

53132-20.....472	53272-18.....473	57107-22.....480	61008-19.....493	61050-03.....510
53132-30.....472	53272-20.....473	57111-21.....480	61008-23.....493	61050-04.....510
53132-40.....472	53272-22.....473	57123-35.....480	61009-16.....494	61050-05.....510
53132-50.....472	53272-24.....473	57125-35.....480	61011-19.....494	61050-07.....510
53132-60.....472	53272-26.....473	57126-34.....481	61011-20.....494	61062-16.....512
53150-00.....472	53272-28.....473	57131-26.....481	61013-18.....494	61063-16.....512
53152-00.....472	53272-30.....473	57137-27.....481	61013-19.....494	61138-14.....513
53154-00.....472	53274-12.....473	57138-21.....481	61013-20.....494	61138-16.....513
53155-00.....472	53276-10.....473	57141-36.....481	61014-15.....495	61138-18.....513
53157-00.....472	53280-01.....474	57146-28.....481	61014-18.....495	61138-20.....513
53158-02.....472	53280-02.....474	57147-28.....481	61015-15.....495	61139-14.....513
53158-03.....472	53280-03.....474	57210-16.....482	61015-18.....495	61139-16.....513
53160-02.....472	53280-04.....474	57210-20.....482	61016-20.....495	61139-18.....513
53160-03.....472	53280-05.....474	57210-25.....482	61017-26.....496	61139-20.....513
53162-00.....472	53280-06.....474	57214-75.....482	61017-27.....496	61140-17.....514
53164-01.....472	53280-07.....474	57230-13.....482	61017-31.....496	61141-16.....514
53164-02.....472	53280-08.....474	57230-17.....482	61017-33.....496	61143-15.....514
53166-00.....472	53280-09.....474	57230-18.....482	61018-28.....497	61145-15.....514
53170-00.....472	53280-10.....474	57234-75.....482	61019-30.....498	61147-17.....514
53175-00.....472	53280-11.....474	57236-20.....483	61020-27.....498	61149-17.....515
53177-01.....472	53290-01.....475	57236-25.....483	61021-24.....499	61151-17.....515
53177-02.....472	53290-02.....475	57236-30.....483	61022-24.....499	61153-16.....515
53230-01.....473	53290-03.....475	57242-20.....483	61023-25.....500	61153-17.....515
53230-02.....473	53290-04.....475	57242-25.....483	61023-26.....500	61156-16.....515
53230-03.....473	53290-05.....475	57242-30.....483	61024-01.....501	61156-17.....515
53230-04.....473	53290-06.....475	57244-13.....483	61024-02.....501	61156-18.....515
53230-05.....473	53290-07.....475	57245-13.....484	61025-20.....502	61157-17.....516
53230-06.....473	53290-08.....475	57246-16.....484	61025-24.....502	61158-10.....516
53230-07.....473	53290-09.....475	57246-21.....484	61025-25.....502	61158-11.....516
53230-08.....473	55111-13.....476	57247-95.....485	61025-26.....502	61158-12.....517
53240-01.....473	55111-14.....476	57248-14.....485	61025-27.....502	61159-12.....517
53240-02.....473	55113-14.....476	57249-01.....485	61026-01.....503	61159-13.....517
53240-03.....473	55115-07.....476	57249-02.....485	61026-02.....503	61161-14.....517
53240-04.....473	55116-15.....476	57251-15.....486	61026-03.....503	61161-18.....517
53240-05.....473	55117-17.....476	57252-19.....486	61026-04.....503	61161-19.....517
53240-06.....473	55118-16.....477	57260-02.....487	61026-05.....504	61172-15.....518
53240-07.....473	55119-16.....477	57260-03.....487	61027-23.....504	61172-16.....518
53240-08.....473	55120-15.....477	57260-04.....487	61027-25.....504	61173-16.....518
53250-01.....473	55122-16.....477	57260-06.....487	61029-25.....504	61174-17.....518
53250-02.....473	55124-16.....477	57260-09.....487	61030-21.....505	61175-17.....518
53250-03.....473	55151-05.....477	57260-16.....487	61030-22.....505	61176-17.....518
53250-04.....473	55151-07.....477	57264-16.....487	61031-17.....505	61177-17.....518
53250-05.....473	55151-09.....477	57266-13.....488	61032-18.....506	61178-16.....519
53250-06.....473	55200-00.....478	57270-00.....489	61032-20.....506	61179-18.....519
53250-07.....473	55220-04.....479	57270-65.....489	61032-23.....506	61180-17.....519
53250-08.....473	55220-05.....479	57270-75.....489	61032-25.....506	61187-16.....519
53260-01.....473	55220-06.....479	57270-80.....489	61033-23.....506	61187-17.....519
53260-02.....473	55220-07.....479	57283-14.....489	61033-24.....506	61188-20.....520
53260-03.....473	55220-08.....479	57284-16.....489	61033-25.....506	61189-21.....520
53260-04.....473	55220-09.....479	57286-16.....489	61034-21.....507	61190-17.....520
53260-05.....473	55220-10.....479	57288-30.....489	61034-23.....507	61191-16.....520
53260-06.....473	55220-11.....479	57289-32.....489	61034-27.....507	61192-17.....520
53260-07.....473	55220-12.....479	57290-20.....490	61034-31.....507	61259-15.....521
53260-08.....473	55220-13.....479	57291-20.....490	61035-21.....507	61261-16.....521
53270-08.....473	55240-04.....479	57301-30.....490	61035-23.....507	61263-16.....521
53270-10.....473	55240-05.....479	57307-24.....490	61035-27.....507	61266-01.....522
53270-12.....473	55240-06.....479	57309-22.....490	61035-31.....507	61266-02.....522
53270-14.....473	55240-07.....479	57311-22.....490	61036-18.....508	61266-03.....522
53270-16.....473	55240-08.....479	57313-22.....490	61036-19.....508	61266-04.....522
53270-18.....473	55240-09.....479	57321-23.....491	61036-23.....508	61266-05.....522
53270-20.....473	55240-10.....479	57323-23.....491	61036-27.....508	61372-01.....523
53270-22.....473	55240-11.....479	57325-15.....491	61037-20.....508	61372-02.....523
53270-24.....473	55240-12.....479	57327-26.....491	61037-21.....508	61372-03.....523
53270-26.....473	55240-13.....479	57329-26.....491	61037-25.....508	61372-04.....523
53270-28.....473	55501-15.....479	61000-21.....492	61037-29.....508	61372-05.....523
53270-30.....473	55503-15.....479	61000-22.....492	61038-12.....509	61372-06.....523
53272-08.....473	55511-21.....479	61001-21.....492	61039-12.....509	61372-07.....523
53272-10.....473	55520-15.....479	61001-22.....492	61040-21.....510	61372-08.....523
53272-12.....473	55520-20.....479	61003-21.....492	61045-18.....511	61372-09.....523
53272-14.....473	55523-17.....479	61003-22.....492	61046-19.....511	61373-01.....523
53272-16.....473	57102-23.....480	61005-22.....493	61050-01.....510	61373-02.....523
	57105-22.....480	61007-22.....493	61050-02.....510	61373-03.....523

61373-04.....	523	61506-00.....	528	63173-06.....	533	65217-18.....	540	67147-27.....	552
61373-05.....	523	61700-01.....	528	63173-07.....	533	65217-21.....	540	67149-27.....	552
61373-06.....	523	61700-33.....	528	63173-08.....	533	65217-23.....	540	67150-00.....	552
61373-07.....	523	61710-01.....	528	63174-00.....	268	65220-13.....	540	67155-00.....	552
61373-08.....	523	61710-33.....	528	63175-27.....	534	65220-22.....	540	67160-00.....	552
61373-09.....	523	61810-05.....	529	63178-01.....	534	65220-25.....	540	67163-00.....	553
61374-01.....	523	61810-10.....	529	63178-03.....	534	65220-28.....	540	67165-00.....	553
61374-02.....	523	61810-15.....	529	63180-17.....	534	65221-13.....	540	67169-00.....	553
61374-03.....	523	61810-20.....	529	63180-21.....	534	65221-22.....	540	67169-01.....	553
61374-04.....	523	61810-25.....	529	63180-24.....	534	65221-25.....	540	67172-20.....	553/1
61374-05.....	523	61810-30.....	529	63180-27.....	534	65221-28.....	540	67172-28.....	553/1
61374-06.....	523	61810-35.....	529	63210-32.....	534	65226-22.....	540	67175-08.....	553/1
61374-07.....	523	61810-40.....	529	63231-01.....	535	65226-25.....	540	67177-11.....	553/1
61374-08.....	523	61810-45.....	529	63231-02.....	535	65226-28.....	540	67178-12.....	553/2
61374-09.....	523	61810-50.....	529	63231-03.....	535	65227-22.....	540	67178-14.....	553/2
61460-15.....	524	61810-70.....	529	63231-04.....	535	65227-25.....	540	67179-14.....	553/2
61460-19.....	524	61810-90.....	529	63231-05.....	535	65227-28.....	540	67184-39.....	554
61461-15.....	524	61820-05.....	529	63231-06.....	535	65230-21.....	541	67185-35.....	554
61461-19.....	524	61820-10.....	529	63232-01.....	536	65230-23.....	541	67201-08.....	554
61461-28.....	525	61820-15.....	529	63232-02.....	536	65230-25.....	541	67201-10.....	554
61462-19.....	524	61820-20.....	529	65102-12.....	537	65231-21.....	541	67201-12.....	554
61462-28.....	525	61820-25.....	529	65102-14.....	537	65231-23.....	541	67201-14.....	554
61463-19.....	524	61820-30.....	529	65108-15.....	537	65231-25.....	541	67201-16.....	554
61463-28.....	525	61820-35.....	529	65110-15.....	537	65236-25.....	541	67201-18.....	554
61464-15.....	524	61820-40.....	529	65120-15.....	537	65237-25.....	541	67201-20.....	554
61464-19.....	524	61820-45.....	529	65120-19.....	537	65238-33.....	541	67201-22.....	554
61464-28.....	525	61820-50.....	529	65120-22.....	537	65239-33.....	541	67201-24.....	554
61465-15.....	524	61820-70.....	529	65120-24.....	537	65241-23.....	542	67201-26.....	554
61465-19.....	524	61820-90.....	529	65124-16.....	537	65242-30.....	542	67201-28.....	554
61465-28.....	525	61910-01.....	530	65124-20.....	537	65255-19.....	543	67201-30.....	554
61466-15.....	524	61910-02.....	530	65124-22.....	537	65256-19.....	543	67201-32.....	554
61466-19.....	524	61910-03.....	530	65124-25.....	537	65259-24.....	543	67201-34.....	554
61466-28.....	525	61910-04.....	530	65124-30.....	537	65260-24.....	543	67201-36.....	554
61467-15.....	524	61920-14.....	530	65130-15.....	537	65261-15.....	544	67205-08.....	554
61467-19.....	524	61920-23.....	530	65132-16.....	538	65262-12.....	544	67205-10.....	554
61467-28.....	525	61930-18.....	530	65132-20.....	538	65263-15.....	544	67205-12.....	554
61468-19.....	524	61930-21.....	530	65140-15.....	538	65263-20.....	544	67205-14.....	554
61468-28.....	525	63101-23.....	531	65140-19.....	538	65265-26.....	545	67205-16.....	554
61469-19.....	524	63103-23.....	531	65145-15.....	538	65265-28.....	545	67205-18.....	554
61469-28.....	525	63106-20.....	531	65150-20.....	538	65270-15.....	545	67205-20.....	554
61470-15.....	524	63107-20.....	531	65154-18.....	538	65272-07.....	545	67205-22.....	554
61470-19.....	524	63110-20.....	531	65160-14.....	539	65272-10.....	545	67205-24.....	554
61471-15.....	524	63111-20.....	531	65160-16.....	539	65274-00.....	545	67205-26.....	554
61471-19.....	524	63117-22.....	531	65160-18.....	539	65280-05.....	546	67205-28.....	554
61471-28.....	525	63125-28.....	532	65160-20.....	539	65280-07.....	546	67205-30.....	554
61472-19.....	524	63130-13.....	532	65160-24.....	539	65280-10.....	546	67205-32.....	554
61472-28.....	525	63130-18.....	532	65164-16.....	539	65282-26.....	546	67205-34.....	554
61473-19.....	524	63130-21.....	532	65164-20.....	539	65284-08.....	546	67205-36.....	554
61473-28.....	525	63142-34.....	532	65168-16.....	539	65284-23.....	546	67205-38.....	554
61481-15.....	524	63150-00.....	532	65168-20.....	539	65290-30.....	547	67205-40.....	554
61481-19.....	524	63150-01.....	532	65170-18.....	539	65291-30.....	547	67206-08.....	554
61482-15.....	524	63150-02.....	532	65170-20.....	539	65310-15.....	548	67206-09.....	554
61482-19.....	524	63150-03.....	532	65172-20.....	539	65310-21.....	548	67206-10.....	554
61482-28.....	525	63150-04.....	532	65172-23.....	539	65310-29.....	548	67206-11.....	554
61483-19.....	524	63150-05.....	532	65174-20.....	539	65310-35.....	548	67206-12.....	554
61483-28.....	525	63150-06.....	532	65178-19.....	539	65320-00.....	549	67206-13.....	554
61484-19.....	524	63150-07.....	532	65178-23.....	539	67101-21.....	550	67206-14.....	554
61484-28.....	525	63150-08.....	532	65180-16.....	539	67103-22.....	550	67206-15.....	554
61488-16.....	526	63150-09.....	532	65210-18.....	540	67105-21.....	550	67206-16.....	554
61489-16.....	526	63150-10.....	532	65210-21.....	540	67105-22.....	550	67206-17.....	554
61490-15.....	526	63150-11.....	532	65210-23.....	540	67106-20.....	550	67206-18.....	554
61491-15.....	526	63150-12.....	532	65211-18.....	540	67110-23.....	550	67206-19.....	554
61492-16.....	526	63150-13.....	532	65211-21.....	540	67111-23.....	550	67206-20.....	554
61493-01.....	527	63170-21.....	533	65211-23.....	540	67122-23.....	551	67206-21.....	554
61493-02.....	527	63170-22.....	533	65216-13.....	540	67123-23.....	551	67206-22.....	554
61493-03.....	527	63170-23.....	533	65216-16.....	540	67125-24.....	551	67206-23.....	554
61495-01.....	527	63173-01.....	533	65216-18.....	540	67130-00.....	552	67206-24.....	554
61495-02.....	527	63173-02.....	533	65216-21.....	540	67130-01.....	552	67206-25.....	554
61495-03.....	527	63173-03.....	533	65216-23.....	540	67130-02.....	552	67206-26.....	554
61495-04.....	527	63173-04.....	533	65217-13.....	540	67130-03.....	552	67206-27.....	554
61500-00.....	528	63173-05.....	533	65217-16.....	540	67132-00.....	552	67206-28.....	554

67206-29.....554	69127-01.....560	69460-00.....568	71300-01.....574	71410-17.....578
67206-30.....554	69127-02.....560	71100-00.....569	71301-01.....574	71410-18.....578
67207-08.....554	69127-03.....560	71110-01.....570	71301-02.....574	71410-19.....578
67207-09.....554	69130-19.....560	71110-02.....570	71301-03.....574	71410-20.....578
67207-10.....554	69142-06.....560	71110-03.....570	71303-01.....574	71410-21.....578
67207-11.....554	69142-08.....560	71115-02.....569	71303-02.....574	71410-22.....578
67207-12.....554	69142-12.....560	71115-03.....569	71303-03.....574	71410-23.....578
67207-13.....554	69147-00.....561	71116-02.....570	71303-04.....574	71410-24.....578
67207-14.....554	69147-02.....561	71120-00.....570	71303-05.....574	71410-25.....578
67207-15.....554	69147-03.....561	71120-01.....570	71305-01.....574	71410-26.....578
67207-16.....554	69147-04.....561	71120-02.....570	71305-02.....574	71410-27.....578
67207-17.....554	69148-00.....561	71120-03.....570	71305-03.....574	71410-28.....578
67207-18.....554	69150-15.....561	71130-01.....570	71305-04.....574	71410-29.....578
67207-19.....554	69210-22.....562	71130-02.....570	71305-05.....574	71410-30.....578
67207-20.....554	69212-16.....562	71130-03.....570	71306-00.....575	71415-01.....578
67207-21.....554	69212-19.....562	71132-00.....570	71306-01.....575	71415-02.....578
67207-22.....554	69212-22.....562	71140-01.....570	71306-02.....575	71415-03.....578
67207-23.....554	69220-05.....562	71140-02.....570	71306-03.....575	71415-04.....578
67207-24.....554	69220-10.....562	71140-03.....570	71306-04.....575	71415-05.....578
67207-25.....554	69220-14.....562	71142-04.....570	71306-05.....575	71415-06.....578
67207-26.....554	69220-20.....562	71150-01.....571	71306-06.....575	71415-07.....578
67207-27.....554	69224-21.....563	71150-02.....571	71306-07.....575	71415-08.....578
67207-28.....554	69224-27.....563	71150-03.....571	71306-08.....575	71415-09.....578
67207-29.....554	69225-22.....563	71160-01.....571	71307-00.....576	71415-10.....578
67207-30.....554	69225-30.....563	71160-02.....571	71308-00.....576	71415-11.....578
67211-06.....555	69226-25.....564	71160-03.....571	71308-01.....576	71415-12.....578
67211-08.....555	69226-29.....564	71161-17.....571	71308-02.....576	71415-13.....578
67211-10.....555	69226-38.....564	71161-25.....571	71308-03.....576	71415-14.....578
67211-12.....555	69227-01.....565	71170-01.....571	71308-04.....576	71415-15.....578
67211-14.....555	69227-02.....565	71170-02.....571	71309-00.....576	71415-16.....578
67211-16.....555	69227-03.....565	71170-03.....571	71310-20.....577	71415-17.....578
67211-18.....555	69227-04.....565	71210-01.....572	71310-25.....577	71415-18.....578
67211-20.....555	69227-05.....565	71210-02.....572	71310-30.....577	71415-19.....578
67211-22.....555	69227-06.....565	71210-03.....572	71310-35.....577	71420-01.....579
67211-24.....555	69228-01.....565	71211-01.....572	71310-40.....577	71420-03.....579
67213-06.....555	69229-01.....565	71211-02.....572	71313-20.....577	71420-05.....579
67213-08.....555	69229-02.....565	71211-03.....572	71313-25.....577	71420-07.....579
67213-10.....555	69251-01.....563	71212-01.....572	71313-30.....577	71420-09.....579
67213-12.....555	69251-02.....563	71212-02.....572	71313-35.....577	71420-11.....579
67213-14.....555	69251-03.....563	71212-03.....572	71313-40.....577	71420-13.....579
67213-16.....555	69261-41.....566	71240-00.....572	71315-40.....577	71420-15.....579
67213-18.....555	69263-30.....566	71240-01.....572	71319-28.....577	71420-17.....579
67213-20.....555	69301-28.....566	71240-02.....572	71319-38.....577	71420-19.....579
67213-22.....555	69301-35.....566	71240-03.....572	71351-10.....577	71420-21.....579
67213-24.....555	69301-42.....566	71240-10.....572	71360-24.....577	71420-23.....579
67219-08.....555	69302-28.....566	71241-00.....572	71361-24.....577	71420-25.....579
67219-10.....555	69302-35.....566	71241-01.....572	71362-24.....577	71424-08.....579
67219-12.....555	69302-42.....566	71241-02.....572	71363-24.....577	71424-13.....579
67219-14.....555	69303-28.....566	71241-03.....572	71364-24.....577	71425-08.....579
67219-16.....555	69303-35.....566	71241-10.....572	71365-24.....577	71426-08.....579
67219-18.....555	69303-42.....566	71242-00.....572	71404-14.....578	71426-13.....579
67219-20.....555	69304-28.....566	71242-01.....572	71404-26.....578	71430-10.....580
67219-22.....555	69304-35.....566	71242-02.....572	71405-14.....578	71430-12.....580
67219-24.....555	69304-42.....566	71242-03.....572	71406-14.....578	71430-14.....580
67240-08.....556	69311-23.....567	71242-10.....572	71406-26.....578	71430-16.....580
67240-11.....556	69311-33.....567	71260-01.....573	71410-01.....578	71430-18.....580
67240-13.....556	69311-40.....567	71260-02.....573	71410-02.....578	71430-20.....580
67240-16.....556	69321-23.....567	71261-01.....573	71410-03.....578	71435-06.....580
67240-21.....556	69321-33.....567	71261-02.....573	71410-04.....578	71436-08.....580
67240-26.....556	69321-40.....567	71262-01.....573	71410-05.....578	71438-13.....580
67240-32.....556	69402-21.....567	71262-02.....573	71410-06.....578	71438-17.....580
67250-07.....556	69402-25.....567	71271-01.....573	71410-07.....578	71438-21.....580
67251-07.....556	69450-18.....568	71271-02.....573	71410-08.....578	71438-25.....580
69105-22.....559	69455-00.....568	71271-03.....573	71410-09.....578	71438-29.....580
69110-15.....559	69456-00.....568	71281-01.....573	71410-10.....578	71438-33.....580
69115-15.....559	69457-12.....568	71281-02.....573	71410-11.....578	71438-37.....580
69121-00.....559	69457-31.....568	71281-03.....573	71410-12.....578	71438-41.....580
69125-17.....559	69458-00.....568	71291-00.....573	71410-13.....578	71441-34.....581
69126-01.....560	69458-10.....568	71291-01.....573	71410-14.....578	71443-29.....581
69126-02.....560	69458-11.....568	71291-02.....573	71410-15.....578	71445-29.....581
69126-03.....560	69458-16.....568	71291-03.....573	71410-16.....578	71502-25.....582

71504-25.....582	71624-07.....591	71715-11.....597	71736-09.....599	73256-42.....607
71505-24.....582	71624-08.....591	71715-12.....597	71736-10.....599	73259-28.....607
71507-28.....582	71624-09.....591	71715-14.....597	71736-11.....599	73302-42.....607
71508-17.....582	71624-10.....591	71717-05.....597	71736-12.....599	73304-46.....607
71510-18.....582	71624-11.....591	71717-06.....597	71737-06.....599	73306-25.....607
71512-20.....583	71624-13.....591	71717-07.....597	71737-08.....599	73309-30.....607
71512-28.....583	71624-14.....591	71717-08.....597	71737-10.....599	75103-15.....608
71514-24.....583	71624-15.....591	71717-09.....597	71737-12.....599	75111-10.....608
71515-24.....583	71624-16.....591	71717-11.....597	71737-14.....599	75113-14.....608
71524-06.....583	71624-17.....591	71717-12.....597	71737-30.....597	75115-14.....608
71524-08.....583	71624-18.....591	71717-14.....597	71737-35.....597	75118-14.....608
71524-10.....583	71624-19.....591	71720-05.....597	71737-40.....597	75121-10.....608
71525-06.....583	71626-00.....592	71720-06.....597	71803-03.....600	75128-01.....608
71525-08.....583	71626-00-25.....592	71720-07.....597	71803-04.....600	75128-02.....608
71525-10.....583	71627-00.....592	71720-08.....597	71803-06.....600	75128-03.....608
71531-23.....583	71628-00.....592	71720-09.....597	71803-08.....600	75128-04.....608
71532-21.....583	71628-00-25.....592	71720-11.....597	71803-10.....600	75128-05.....608
71533-21.....583	71630-00.....590	71720-12.....597	71803-12.....600	75128-06.....608
71536-21.....584	71632-00.....593	71720-14.....597	71803-14.....600	75129-01.....608
71536-28.....584	71634-00.....593	71720-15.....597	71803-15.....600	75129-02.....608
71537-27.....584	71635-26.....593	71720-16.....597	71810-12.....601	75129-03.....608
71539-26.....584	71641-17.....594	71720-19.....597	71810-16.....601	75129-04.....608
71540-27.....585	71643-27.....594	71720-20.....597	71810-20.....601	75129-05.....608
71542-20.....585	71645-01.....594	71722-05.....597	71810-50.....601	75129-06.....608
71543-32.....585	71645-02.....594	71722-06.....597	73101-23.....602	75130-01.....608
71545-27.....585	71645-03.....594	71722-07.....597	73102-30.....602	75130-02.....608
71547-23.....585	71646-01.....594	71722-08.....597	73105-33.....602	75130-03.....608
71549-25.....585	71646-02.....594	71722-09.....597	73105-36.....602	75138-00.....608
71559-26.....586	71650-00.....596	71722-11.....597	73107-30.....602	75140-02.....608
71565-28.....586	71650-01.....596	71722-12.....597	73108-36.....602	75140-03.....608
71567-26.....586	71650-02.....596	71722-14.....597	73108-39.....602	75140-04.....608
71580-32.....586	71650-03.....596	71722-15.....597	73110-41.....602	75140-05.....608
71581-32.....586	71650-04.....596	71722-16.....597	73115-32.....602	75140-06.....608
71582-32.....586	71650-05.....596	71722-19.....597	73115-38.....602	75140-07.....608
71583-32.....586	71650-06.....596	71722-20.....597	73119-36.....602	75140-08.....608
71584-28.....586	71650-07.....596	71725-05.....597	73119-40.....602	75301-10.....609
71585-25.....586	71660-00.....596	71725-06.....597	73125-40.....603	75304-10.....609
71590-04.....587	71702-01.....594	71725-07.....597	73127-40.....603	75305-10.....609
71592-01.....587	71702-02.....594	71725-08.....597	73135-36.....603	75331-14.....609
71592-02.....587	71702-03.....594	71725-09.....597	73139-40.....603	75341-11.....609
71592-03.....587	71702-04.....594	71725-11.....597	73141-39.....603	75343-13.....609
71592-04.....587	71702-05.....594	71725-12.....597	73143-39.....603	75373-10.....610
71593-00.....587	71702-06.....594	71725-14.....597	73145-36.....603	75378-10.....610
71594-40.....587	71703-01.....595	71725-15.....597	73147-36.....603	75379-10.....610
71596-40.....587	71703-02.....595	71725-16.....597	73148-17.....603	75382-16.....610
71598-27.....587	71703-03.....595	71725-19.....597	73151-29.....604	75386-10.....610
71604-01.....588	71703-04.....595	71725-20.....597	73155-44.....604	75386-12.....610
71604-02.....588	71703-05.....595	71727-05.....597	73157-40.....604	75396-01.....611
71604-21.....588	71703-06.....595	71727-06.....597	73162-40.....604	75396-02.....611
71604-28.....588	71704-27.....595	71727-07.....597	73170-00.....604	75397-00.....611
71605-26.....588	71710-05.....597	71727-08.....597	73171-21.....604	75400-01.....612
71606-24.....588	71710-06.....597	71727-09.....597	73181-33.....605	75400-02.....612
71611-25.....588	71710-07.....597	71727-11.....597	73183-27.....605	75400-03.....612
71612-21.....588	71710-08.....597	71727-12.....597	73184-21.....605	75400-04.....612
71613-28.....589	71710-09.....597	71727-14.....597	73187-09.....605	75410-01.....612
71615-01.....589	71710-11.....597	71727-15.....597	73189-09.....605	75410-02.....612
71615-02.....589	71710-12.....597	71727-16.....597	73191-34.....605	75410-03.....612
71617-04.....589	71710-14.....597	71727-19.....597	73193-30.....605	75410-04.....612
71618-23.....589	71712-05.....597	71727-20.....597	73195-35.....605	75420-15.....612/1
71619-23.....589	71712-06.....597	71730-30.....597	73242-27.....606	75430-01.....612/1
71621-01.....590	71712-07.....597	71730-35.....597	73243-27.....606	75430-12.....612
71621-01-25.....590	71712-08.....597	71730-40.....597	73244-01.....606	75430-13.....612
71622-00.....590	71712-09.....597	71732-30.....597	73244-02.....606	75440-00.....612
71622-00-25.....590	71712-11.....597	71732-35.....597	73244-03.....606	75440-11.....612/1
71623-00.....590	71712-12.....597	71732-40.....597	73245-01.....606	75450-00.....612
71623-00-25.....590	71712-14.....597	71735-30.....597	73245-02.....606	75450-13.....612/2
71624-01.....591	71715-05.....597	71735-35.....597	73245-03.....606	75460-13.....612/2
71624-03.....591	71715-06.....597	71735-40.....597	73252-30.....606	75470-11.....612/2
71624-04.....591	71715-07.....597	71736-00.....599	73254-14.....606	75475-11.....612/2
71624-05.....591	71715-08.....597	71736-07.....599	73254-18.....606	75480-13.....612/2
71624-06.....591	71715-09.....597	71736-08.....599	73254-21.....606	75485-13.....612/2

75490-15.....612/2	89140-02.....620	89179-29.....622	91011-55.....629
75500-15.....612/2	89140-05.....620	89179-34.....622	91011-56.....629
75550-13.....613	89140-10.....620	89179-39.....622	91011-61.....629
75600-10.....613	89140-20.....620	89179-49.....622	91011-62.....629
75618-15.....613	89141-10.....620	89179-59.....622	91020-01.....629
75620-15.....613	89142-01.....620	R390.03.....622	91020-02.....629
75630-12.....614	89142-02.....620	R390.05.....622	91020-03.....629
75640-15.....614	89142-03.....620	R390.07.....622	91020-04.....629
89111-25.....615	89142-04.....620	R390.10.....622	91022-05.....629
89111-32.....615	89142-05.....620	R190.03.....622	91022-10.....629
89112-65.....615	89142-06.....620	R190.05.....622	91022-20.....629
89113-65.....615	89142-07.....620	R190.07.....622	91024-10.....629
89114-00.....615	89145-23.....620	R190.10.....622	91024-15.....629
89115-50.....615	89145-30.....620	R191.03.....622	91024-20.....629
89115-65.....615	89145-31.....620	R191.05.....622	91030-02.....629
89115-75.....615	89145-35.....620	R191.07.....622	91030-04.....629
89116-50.....615	89146-20.....268/621	R191.10.....622	91030-06.....629
89116-65.....615	89147-10.....621	89250-10.....623	91102-11.....630
89116-75.....615	89147-21.....620	89250-20.....623	91104-11.....630
89117-20.....616	89147-24.....620	89250-30.....623	91109-11.....630
89117-23.....616	89147-25.....621	89250-40.....623	91113-11.....630
89117-27.....616	89147-30.....620	89250-50.....623	91115-11.....630
89118-20.....616	89147-31.....620	89250-60.....623	91122-16.....630
89118-23.....616	89147-35.....620	89255-60.....623	91123-16.....630
89118-27.....616	89147-40.....620	89256-29.....623	91124-16.....630
89122-16.....617	89147-42.....620	89256-46.....623	91125-16.....630
89122-21.....617	89148-25.....621	89256-67.....623	91127-16.....630
89122-26.....617	89148-31.....621	89257-46.....623	91142-16.....631
89122-30.....617	89148-32.....621	89260-13.....624	91144-16.....631
89124-23.....618	89148-35.....621	89260-17.....624	91146-16.....631
89124-26.....618	89148-50.....621	89260-20.....624	91152-19.....631
89124-27.....618	89149-13.....621	89260-25.....624	91154-19.....631
89124-30.....618	89149-20.....621	89260-30.....624	91157-19.....631
89124-32.....618	89150-30.....621	89260-40.....624	91159-19.....631
89124-42.....618	89152-08.....622	89265-12.....624	91162-19.....632
89125-23.....618	89152-10.....622	89270-15.....624	91164-19.....632
89125-26.....618	89152-12.....622	89500-00.....626	91166-19.....632
89125-30.....618	89155-08.....622	89500-01.....626	91167-19.....632
89125-32.....618	89155-10.....622	89500-02.....626	91169-19.....632
89125-42.....618	89155-13.....622	89500-03.....626	91172-03.....632
89126-23.....618	89155-15.....622	89500-04.....626	91172-07.....632
89126-26.....618	89155-19.....622	89500-05.....626	91172-12.....632
89126-27.....618	89159-14.....622	89500-06.....626	91190-30.....633
89126-30.....618	89159-16.....622	89500-07.....626	91190-50.....633
89126-32.....618	89159-19.....622	89500-08.....626	91191-30.....633
89126-42.....618	89159-24.....622	89500-09.....626	91192-30.....633
89127-04.....619	89164-14.....622	89500-10.....626	91192-50.....633
89127-06.....619	89164-16.....622	89500-11.....626	91193-30.....633
89127-08.....619	89164-19.....622	89500-12.....626	91193-50.....633
89127-11.....619	89164-24.....622	89501-03.....626	98000-01.....634
89127-12.....619	89164-29.....622	91010-01.....628	98000-02.....634
89127-14.....619	89164-34.....622	91010-02.....628	
89127-16.....619	89164-39.....622	91010-03.....628	
89127-18.....619	89169-14.....622	91010-11.....628	
89127-23.....618	89169-16.....622	91010-12.....628	
89127-26.....618	89169-19.....622	91010-13.....628	
89127-30.....618	89169-24.....622	91010-14.....628	
89127-32.....618	89169-29.....622	91010-15.....628	
89127-42.....618	89169-34.....622	91010-16.....628	
89129-11.....619	89169-39.....622	91010-17.....628	
89133-16.....619	89174-14.....622	91010-18.....628	
89133-17.....619	89174-16.....622	91010-21.....628	
89133-22.....619	89174-19.....622	91010-31.....628	
89133-24.....619	89174-24.....622	91010-33.....628	
89133-25.....619	89174-29.....622	91010-34.....628	
89133-31.....619	89174-34.....622	91010-35.....628	
89133-34.....619	89174-39.....622	91010-36.....628	
89133-38.....619	89179-14.....622	91011-51.....629	
89139-17.....619	89179-16.....622	91011-52.....629	
89139-25.....619	89179-19.....622	91011-53.....629	
89139-27.....619	89179-24.....622	91011-54.....629	

Anlegezange, OLIVECRONA-TOENNIS	326	anatomische Pinzette, POTTS-SMITH.....	81	Arterienklemme, MAYO-GUYON.....	122
Abfallzange, SAUERBRUCH	227	anatomische Pinzette, SEMKEN	86	Arterienklemme, MEEKER.....	119
Abortuskürette, PESTALOZZA	606	anatomische Pinzette, TAYLOR.....	87	Arterienklemme, Micro-HARTMANN	104
Abortuslöffel, CUZZI.....	606	anatomische Pinzette, TC	81	Arterienklemme, MIXTER	119/1
Abortuslöffel, WALLICH.....	607	anatomische Pinzette, STILLE	81	Arterienklemme, MIXTER-BABY	119/1
Abortuszange, SAEGER	606	ANDERSON-ADSON, Wundspreizer	172	Arterienklemme, MOYNIHAN	120
Abortuszange, WINTER.....	606	ANDERSON, Wundhaken	198	Arterienklemme, O'SHAUGNESSY	119/2
ABRAHAM, Tonsillenfaßzange	468	ANDREW, Zungendrücker	452	Arterienklemme, OVERHOLT	114
ABRAHAM, Tonsillennmesser	466	ANDREW-PYNCHON, Saugrohr	28	Arterienklemme, PEAN	108, 110
Absaugküretten	600	Anestophon	23	Arterienklemme, PENNINGTON	109
Absaugrohr, BUIE	566	Aneurysmaklemme, DeBAKEY-BAHNSON	506	Arterienklemme, PROVIDENCE-HOSPITAL	106
ADLERKREUTZ, Gefäßpinzette.....	84	Anlegepinzette, MEHDORN	362	Arterienklemme, ROBERTS	117
ADSON, anatomische Pinzette	81/2	Anlegezange	357 - 360	Arterienklemme, ROCHESTER-CARMALT	109
ADSON, Arterienklemme	112	Anlegezange, JOHNS-HOPKINS	104	Arterienklemme, ROCHESTER-OCHSNER	108
ADSON-BABY, Arterienklemme	113	Anlegezange, McKENZIE	326	Arterienklemme, ROCHESTER-PEAN	108
ADSON-BABY, Wundspreizer	173	Anlegezange, SMITHWICK.....	326	Arterienklemme, RUMEL	117
ADSON, chirurgische Pinzette	81/2	Anlegezange, SWEET	326	Arterienklemme, SAROT	118
ADSON, Durahaken.....	329	ANTRUM, Kürette.....	435	Arterienklemme, SPENCER-WELLS	109
ADSON, Halteklemme	298	Antrumkürette, COAKLEY	449	Arterienklemme, STILLE	122
ADSON, Hohlmeißelzange	236	Antrumraspel, WIENER	443	Arterienklemme, TOENNIS.....	117
ADSON, Hypophysepinzette	334	Antrumraspel, GALLAHER	446	Arterienklemme, ZENKER	118
ADSON-Micro, anatomische Pinzette.....	81/2	Anuskop, HIRSCHMANN	562	Arterienklemme, OVERHOLT-MIXTER.....	115
ADSON-Micro, chirurgische Pinzette	82	Anuskop, IVES-FANSLER	562	Arterienklemme, OVERHOLT-BABY	114
ADSON, Nadelhalter.....	211	Anuskop, KELLY	562, 563	Arterienklemme, OVERHOLT-GEISSENDOERFER.....	114
ADSON, Raspator	282	ANVIL, Nagelspaltzange.....	613	Arterienklemme, OVERHOLT-MIXTER.....	115
ADSON, Saugrohr	337	Aorta-Aneurysmaklemme, DeBAKEY	496 - 498	ASCH, Septumrichtzange	449
ADSON, Wundspreizer	172 - 174	Aortadilatator, COOLEY	528	Atrauma-Arterienklemme, DeBAKEY-MOSQUITO	509
ADSON-BROWN, chirurgische Pinzette	82	Aortadilatator, TUBBS	528	Atrauma-Arterienklemme, DeBAKEY-PEAN.....	513
AEBLI, Ophthalmologie-Schere	58	Aortaklemme, DIETRICH	510	Atrauma-Arterienklemme, DeBAKEY-RANKIN	512
AESCLAP, Verbindungskabel	633	Aortaklemme, MORRIS-DeBAKEY	506	Atrauma-Bulldogklemme, DeBAKEY	103
Ahle, OBWEGESER	463, 463/3	Aortaklemme, DeBAKEY	499, 500	Atrauma-Bulldogklemme, GLOVER	103
AIR-INJECTION, Augenkanüle	394	Aortaklemme, WEBER.....	501	Atrauma-Darmfaßzange	539
ALAN-PARKS, Mastdarm-Spekula	561	Approximator, BIEMER	366	Atraumaklemmen.....	492 - 523, 526, 527
ALDERDYCE, Elevator	282	Approximator, BIEMER-MÜLLER	363	Atrauma-Neonatalklemme.....	523
ALEXANDER, Biopsiezange	589	Approximator, MÜLLER.....	364	Atrauma-Pinzette, DeBAKEY	98
ALEXANDER, Flachmeißel	259	ARCHER, Splitterzange.....	92	Atrauma-Pinzette, DeBAKEY TC	99
ALEXANDER, Hohlmeißel	259	ARLT, Starschlinge	378	Atrauma-Gefäßklemme, BECK	516
ALEXANDER, Raspator	276	Armsystem	188, 189	AUFBRANC-COBRA, Knochenhebel	289
ALEXANDER, Uterus-Biopsiezange	589	ARRUGA, Extraktionshaken	375	AUFBRANC-COBRA, Wundhaken	289
ALLEN, Blinddarmklemme	544	ARRUGA, Kapselpinzette	391	Aufreiber, KUENTSCHER	321
ALLIS, Darmfaßzange	537	ARRUGA, Lidsperrerr	370	AUFRICHT, Nasenhaken	447
ALLIS-ADAIR, Darmfaßzange.....	537	ARRUGA, Nadelhalter	214	AUFRICHT, Nasenraspel	443
ALLIS-BABY, Darmfaßzange	537	ARRUGA, Wundlöffel.....	378	Aufsatz allein f. Uterus-Biopsiezangen	591
ALLISON, Lungenspatel	489	Arterienklemme, BIRKETT	116	Aufsatz f. Reinigungspistole.....	626
ALM, Wundhaken	168	Arterienklemme, MIXTER	116	Aufsatz, BARACANI.....	472
ALU, Stimmgabeln	403	Arterienklemme, ADSON	112	Aufsatz, BRUENINGS	472
ALVIS, Fremdkörperkürette	374	Arterienklemme, ADSON-BABY	113	Aufsatz, CORDES.....	472
Amnioskop	601	Arterienklemme, BAINBRIDGE	119/2	Aufsatz, FRAENKEL	472
Amniotom, BEACHAM	586	Arterienklemme, BENGOLEA	112	Aufsatz, KRAUSE	472
Amputationsmesser, CATLIN.....	44	Arterienklemme, CRAFOORD	118	Aufsatz, LANGE	472
Amputationsmesser, LANGENBECK	44	Arterienklemme, CRAFOORD-SELLORS	119	Aufsatz, SCHEINMANN	472
Amputationsmesser, LISTON	44	Arterienklemme, CRILE	107	Aufsatz, SCHUMACHER	472
Amputationsmesser, REDA	44	Arterienklemme, CRILE-RANKIN	107	Aufsatz, SEIFERT	472
Amputationssäge, BIER	296	Arterienklemme, DANDY	109	Aufsätze f. SLUDER-BALLENGER	470
Amputationssäge, CHARRIERE	296	Arterienklemme, DESJARDINS	121	Augenkanüle, AIR-INJECTION	394
Amputationssäge, SATTERLEE	296	Arterienklemme, FUCHSIG	113	Augenkanüle, JENSEN	394
Analspreizer, SMITH-BUIE.....	561	Arterienklemme, GEMINI	115	Augenkanüle, LACRIMAL	394
Anastomosenklemme, BECK	516, 520	Arterienklemme, GRAY	121	Augenkanüle, McINTYRE	394
Anastomosenklemme, COOLEY-DERRA	519	Arterienklemme, GUYON	122	Augenkanüle, SHEETS.....	394/2
Anastomosenklemme, DE MARTEL-WOLFSON.....	546	Arterienklemme, HALSTED-MOSQUITO	105	Augenkanülen	394
Anastomosenklemme, DeBAKEY	505	Arterienklemme, HARTMANN	104	Augenmagnet, REDA	395
Anastomosenklemme, LAMBERT-KAY	505	Arterienklemme, HEISS.....	112	Augenschere, BARRAQUER	75
Anastomosenklemme, DERRA	515	Arterienklemme, JACOBSON	105	Augenschere, NOYES	75
Anastomosenklemme, POTTS	493	Arterienklemme, JOHNS-HOPKINS	120	Augenschere, VANNAS	79
anatomische Pinzette, BROPHY	84	Arterienklemme, KANTROWITZ	119/1	Augenschere, WECKER	75
anatomische Pinzette	81	Arterienklemme, KELLY	106	Augenschere, WESTCOTT	75
anatomische Pinzette, ADSON	81/2	Arterienklemme, KELLY-RANKIN	106	Aurikelklemme, HARKEN	503
anatomische Pinzette, ADSON-Micro.....	81/2	Arterienklemme, KOCHER	108	Autopsiesäge.....	231/1
anatomische Pinzette, BONNEY	88	Arterienklemme, LAHEY	119/2	AUVARD, Scheidenspekula	576
anatomische Pinzette, CUSHING	83	Arterienklemme, LAWRENCE	119	AXENFELD, Chlazonionskürette	377
anatomische Pinzette, GERALD	86, 87	Arterienklemme, LERICHE	111	AYER, Chlazonionspinzette	393
anatomische Pinzette, McINDOE	85	Arterienklemme, LOVEFACE	109		
anatomische Pinzette, USA	81	Arterienklemme, LOWER	120		

B	Bauchdeckenhalter, DE BAKEY	189/1	Biopsiezange, THOMAS-GAYLOR	588	
BABCOCK, Darmfäßzange	539	Bauchdeckenhalter, DOYEN	189/1	Biopsiezange, TISCHLER-DOWN	591
BABINSKI, Perkussionshammer	24	Bauchdeckenhalter, GELPI	189/1, 189/2	Biopsiezange, TISCHLER-MORGAN	591
BABY- BURKE, Uterus-Biopsiezange	590	Bauchdeckenhalter, RIGBY	189/2	Biopsiezange, TISCHLER-UP	591
BABY-GOSSET, Bauchdeckenhalter	181	Bauchdeckenhalter, JACKSON-BURROWS	189/2	Biopsiezange, TOWNSEND	591
BABY-KÖCHER, Darmklemme	540	Bauchspatel	143	Biopsiezange, VAN DOREN	588
BABY-METZENBAUM, Supercutschere	71	Bauchspatel, KADER	143/1	Biopsiezange, WITNER	589
BABY-OLSEN-HEGAR, Nadelhalter	212	Bauchspatel, KÖRTE	143/1	Bipolare Koagulation	630 - 633
BABY-WEBSTER, Nadelhalter	208	Bauchspatel, KÜMMEL	143/2, 144	Bipolarkabel	633
BABY-YANKAUER, Saugrohr	27	Bauchspatel, LERICHE	143/2	Bipolarpinzette	630 - 632
BABYPHON, Blutdruckmeßgerät	10	BAUMGARTNER, Nadelhalter	208	BIRCHER-GANSKE, Knochenhaltezange	246
BABY-TISCHLER, Uterus-Biopsiezange	592	BEACHAM, Amniotom	586	BIRKETT, Arterienklemme	116
BACKHAUS, Tuchklemme	132	BECHERT, Linsenmanipulator	379	BISHOP-HARMAN, Irispinzette	386
BACKHAUS-CLIP, Tuchklemme	132	BECK, Anastomosenklemme	516, 520	BISHOP-HARMON, Spül- und Saugkanüle	394/1
BAILEY-BABY, Rippenkontraktor	489	Beckenzirkel, COLLIER	605	BLAKE, Gallensteinzange	531
BAILEY-GIBBON, Rippenkontraktor	489	Beckenzirkel, COLLIN	605	BLAKE, Uteruskürette	595
BAILEY, Rippenkontraktor	489	Beckenzirkel, MARTIN	605	Blasenhalssperrer, MILLIN	553
BAINBRIDGE, Arterienklemme	119/2	BECKER, Cystotom	375	Blasenspatel, KÖCHER	552
BAINBRIDGE, Mehrzweck-Gefäßklemme	495	BECKMANN, Ringmesser	450	Blasenspatel, LEGUEU	552
BAKES, Gallengangdilator	532	BECKMANN, Wundspreizer	176	Blasenwundspreizer, LEGUEU	553
BALFOUR-BABY, Bauchdeckenhalter	182	BECKMANN-ADSON, Wundspreizer	175	Blasenwundspreizer, MILLIN	552
BALFOUR, Bauchdeckenhalter	182	BECKMANN-EATON, Wundspreizer	176	Blasenwundspreizer, THOMSON-WALKER	552
BALFOUR, Haken	193	BEEBEE, Kronenschere	68	Blasenwundspreizer, JUDD-MASSON	552
BALFOUR, Valve f. Bauchdeckenhalter	183	BEER, Cilienpinzette	395	Blattosteotom, OBWEGESER	464/1
BALFOUR-US, Bauchdeckenhalter	184	BEESON, Gips spreizer	232	Bleihand	250
BALL AND SOCKET, Tuchklemme	133	Beinhautmesser	47	Blinddarmklemme, ALLEN	544
BALLENGER, Schwingmesser	436	Beleuchtungsstab f. MORGAN	565	Blinddarmklemme, KLEINSCHMIDT	544
BALLENGER, Septumelektor	439	BELLUCCI, Mikro-Ohrscherchen	413, 417	BLOHME, Tonsillenzange	467
BALLENGER, Tonsillenzange	467	BENDER, Einschläger	322	BLOUNT, Knochenhebel	288
Bandmaß	25	BENGOLEA, Arterienklemme	112	BLOUNT, Meniskushaken	289
Bandscheibenstanze, FERRIS-SMITH-KERRISON	344, 344/2	BENNETT, Knochenhebel	283	BLUMENTHAL, Hohlmeißelzange	236
Bandscheibenstanze, COLCLOUGH	344/1	BENSAUDE, Proktoskop	565	Blutdruckmessgerät, BABYPHON	10
BANE-HARTMANN, Hohlmeißelzange	237	BENSON, Pylorus spreizer	544	Blutdruckmessgerät, DIPLOMAT	5
BANGERTER, Zykliodialysespatel	379	BERENS, Diszisionsmesser	372	Blutdruckmessgerät, EXACTA	8
BARACANI, Aufsatz	472	BERGMANN, Hammer	272	Blutdruckmessgerät, PRECISA	9
BARANY, Lärmtrommel	405	BERGMANN, Verbandschere	69/1	Blutschöpföffel	268
BARBARA, Häkchen	419	BERKE, Beckelpinzette	389	Blutstillungsmeißel, PASSOW	260
BARBARA, Nadel	419	BERLINER, Perkussionshammer	24	BODENHAMMER, Mastdarmspekula	559
BARKAN, Goniotomiemesser	373	BERNHARD, Tuchklemme	133	BOEHLER, Extensionsbügel	312
BARNHILL, Ringmeser	450	BERRY, Drahtzange	319	BOERMA, Geburtszange	604
BARON, Saugrohr	336	Beschaidungsgerät, MOGEN	556	BOETTCHEr, Tonsillenschere	59
BARR, Mastdarmspekula	559	BETHUNE, Rippenschere	481	BÖHLER, Hohlmeißelzange	238
BARRAQUER, Augenschere	75	Biegehebel, LANE	325	BÖHLER, Knochensplitterzange	241
BARRAQUER, Cilienpinzette	395	BIEMER, Approximator	366	Bohrapparat, STILLE-SHERMAN	298
BARRAQUER, Fixationspinzette	390	BIEMER, Gefäßclip	361	Bohrdraht, KIRSCHNER	306, 307
BARRAQUER, Irispinzette	384	BIEMER-MÜLLER, Approximator	363	Bohrdrahtspender	305, 310
BARRAQUER Keratoplastik-Messer	373	BIER, Amputationssäge	296	Bohrdrahtstütze	299
BARRAQUER, Lidsperrer	370	BILL, Zughebel	604	Bohrer	298, 302
BARRAQUER, Nadelhalter	216, 217	BILLEAU, Ohrschlinge	409	Bohrer, CRUTCHFIELD	327
BARRAQUER-KATZIN, Irispinzette	384	Biopsie- und Absaugkürette	600	Bohrer, ERRICO	299
BARRAQUER-TROUTMAN, Nadelhalter	216	Biopsiekannüle, MENGHINI	206	Bohrer, Mc KENZIE	299
BARRET, Hakenzange	582	Biopsiekürette, HEANY	587	BOIES, Elevator	277
BARTON, Geburtszange	603	Biopsiekürette, KEVORKIAN	587	Bolzenschneider	320
BARTON, Zughebel	603	Biopsiekürette, MOD. MÜNCHEN	587	BONACCOLTO, Strabismuspinzette	385
Batteriegriff f. Kaltlicht	33	Biopsiekürette, NOVAK	587	BONN, Irispinzette	387
Batteriegriff f. Warmlicht	32	Biopsiekürette, RANDALL	587	BONNEY, anatomische Pinzette	88
Bauch- u. Darmspatel, KÜMMEL	143/2	Biopsieküretten	600	BONNEY, chirurgische Pinzette	88
Bauchdeckenhalter, BABY-GOSSET	181	Biopsienadel, FRANKLIN-SILVERMANN	206	BOSE, Trachealhaken	477
Bauchdeckenhalter, BALFOUR	182	Biopsiezange, KEVORKIAN-PACIFIC	592	BOSE, Trachealspreizer	476
Bauchdeckenhalter, BALFOUR-BABY	182	Biopsiezange, TISCHLER-KEVORKIAN	592	BOUCHERON, Ohrspekula	399
Bauchdeckenhalter, BALFOUR-US	184	Biopsiezange, TISCHLER-MORGAN	590	BOWMAN, Diszionsmesser	372
Bauchdeckenhalter, CHARNELY	289	Biopsiezange, ALEXANDER	589	BOWMAN, Diszisionsnadel	374
Bauchdeckenhalter, COLLIN	190	Biopsiezange, BABY-TISCHLER	592	BOWMAN, Lidsperrer	370
Bauchdeckenhalter, COLLIN-LOKITTLE	191	Biopsiezange, BURKE	590	BOWMAN, Tränenkanalsonde	381
Bauchdeckenhalter, DENIS-BROWNE	185	Biopsiezange, BURKE-BABY	590	Box, PETRI	620
Bauchdeckenhalter, FRAZIER	181	Biopsiezange, EPPENDORFER	590	BOYNTON, Nadelhalter	214
Bauchdeckenhalter, GOSSET	181	Biopsiezange, FAURE	588	BOYS-ALLIS, Darmfäßzange	538
Bauchdeckenhalter, KIRSCHNER	185, 187, 187/1	Biopsiezange, KEVORKIAN	589, 591	BOZEMANN, Nadelhalter	211
Bauchdeckenhalter O'SULLIVAN-O'CONNOR	181	Biopsiezange, MAXI GRASPER	593	BOZEMANN, Tamponzange	138
Bauchdeckenhalter, RICARD	181	Biopsiezange, MINI-TOWNSEND-DOWN	591	BOZEMANN-DOUGLAS, Tamponzange	138
Bauchdeckenhalter, ROCHARD	186	Biopsiezange, MINI-TOWNSEND-UP	591	BRAND, Sehnenfaßinstrument	293
Bauchdeckenhalter, COLLIN	190	Biopsiezange, SCHUBERT	588	BRAND, Sehenschäler	294
		Biopsiezange, SCHUMACHER	588, 589	BRAUN, Dekapitationshaken	607

BRAUN, Hakenzange	582	CASPAR, Stössel	258	Circumcisionsgerät	556
BRAUN, Kranioklast	607	CASPAR, Wundspreizer	179	CITELLI, Knochenstanze	430
BRAUN, Uterusdepressor	586	CASTANEDA, Neonatal-Gefäßklemme	527	CLAR, Stirnlampe	22
BRAUN-STADLER, Episotomie-Schere	64	CASTROVIEJO, Disziionsmesser	372	CLARK, Lidsperrrer	370
BREAST, Wundhaken	198	CASTROVIEJO, Fixierpinzette	390	CLAUS, Tonsillennadel	466
BREISKY, Scheidenspekula	577	CASTROVIEJO, Hornhautschere	79	CLAUS-EICKEN, Tonsillennadel	466
Breiten-Messinstrument	594	CASTROVIEJO, Kapselpinzette	391	CLAYMAN, Hähchen	376
BRISTOW, Knochenhebel	290	CASTROVIEJO, Klängenbrecher	45	CLEVELAND, Hohlmeißelzange	235
BRODIE, Hohlsonde	199	CASTROVIEJO, Lidsperrrer	371	Clipanlegezange, ETHICON	524, 525
Bronchoskopiezange, CHEVALIER-JACKSON	473	CASTROVIEJO, Meßzirkel	380	Clipanlegezange, HORIZON	524, 525
Bronchusklemme	126	CASTROVIEJO, Nadelhalter	215, 216	Clipanlegezange, PILLING	524, 525
Bronchusklemme, FINOCCHIETTO	490	CASTROVIEJO, Nahtpinzette	392	Clipanlegezange, SLS Clips	524, 525
Bronchusklemme, HARRINGTON	490	CASTROVIEJO, Tränenkanaldilatator	381	CLOWARD, Laminektomiezange	342
Bronchusklemme, LEES	504	CASTROVIEJO, Zykloalysespatel	379	CLOWARD, Wirbelkörperspreizer	339
Bronchusklemme, PRICE-THOMAS	490	CASTROVIEJO-Micro, Nadelhalter	215	CLOWARD, Wundsperrerr	178
Bronchusklemme, SEMB	491	CASTROVIEJO-STANDARD, Nadelhalter	216	COAKLEY, Antrumkürette	449
BROPHY, anatomische Pinzette	84	CATLIN, Amputationsmesser	44	COAKLEY, Kieferhöhentroker	204
BROPHY, chirurgische Pinzette	84	Cauter, WADSWORTH-TODD	378	Coarctationsklemme, DeBAKEY	507
BROWN, Gewebepinzette	83	CAWOOD-MINNESOTA, Wangenhalter	451	Coarctationsklemme, POTTS	492
BROWN, Nadelhalter	209	Chalazionskürette, AXENFELD	377	COBB, Hohlmeißel	262
BRUENINGS, Aufsatz	472	Chalazionskürette, HEBRA	377	COBB, Kürette	252
BRUENINGS, Ohrspekula	401	Chalazionskürette, MEYHOEFER	377	COBB, Raspator	280
BRUENINGS, Septumzange	425	Chalazionspinzette, AYER	393	COBB, scharfer Löffel	252
BRUENINGS, Tonsillennmesser	466	Chalazionspinzette, DESMARES	393	COLCLOUGH, Bandscheibenstanze	344/1
BRUENINGS, Tonsillenschürer	468	Chalazionspinzette, LAMBERT	393	COLLER-CRILE, Arterienklemme	106
BRUENINGS, Verlängerungsrohr	472	CHANDLER, Elevator	282	COLLIER, Beckenzirkel	605
BRUENINGS, Zungenspatel	451	CHAPUT, Gewebefaßzange	110	COLLIER, Nadelhalter	208
BRUNETTI, Meißel	268	CHARNLEY, Bauchdeckenhalter	289	COLLIN, Bauchdeckenhalter	190
BRÜNINGS-LUCAS, Flachmeißel	260	CHARRIERE, Amputationssäge	296	COLLIN, Beckenzirkel	605
BRUNNER, Darmklemme	543	CHATEL, Sterilisierzange	227	COLLIN, Darmfaßzange	539
BRUNNER, Führungshohlsonde	221	CHELSEA-EATON, Proktoskop	563	COLLIN, Dynamometer	25
BRUNNER, Rippenschere	481	CHERON, Tupferzange	137	COLLIN, Gewebefaßzange	110
BRUNNER, Wundhaken	167	CHERRY, Laminektomiesperrrer	488	COLLIN, Hammer	270
BRUNS, scharfer Löffel	251	CHEVALIER-JACKSON, Bronchoskopiezange	473	COLLIN-LOKTITE, Bauchdeckenhalter	191
BRUNS, Verbandschere	70	CHEVALIER-JACKSON, Trachealkanüle	479	COLLIN, Nabelschnurklemme	605
Bruststütze, KLEINSASSER	36	CHILDE, Wundklammerzange	224	COLLIN, Scheidenspekula	570
Bruststütze, NEGUS	459	chirurgische Nadel, KEITH	223	COLLIN, Sonde	586
BRYANT, Tupferzange	137	chirurgische Nadel, KOENIG	223	COLLIN, Tupferzange	137
BUCHWALD, Zungenspatel	451	chirurgische Nadeln	222	COLLIN, Uterus-Faßzange	585
BUCK, Fremdkörperhebel	412	chirurgische Pinzette	81/1	COLLIN, Uterus-Sonde	586
BUCK, Ohrkürette	407	chirurgische Pinzette, GERALD	87	COLLIN, Wundhaken	139
BUCK, Perkussionshammer	24	chirurgische Pinzette, POTTS-SMITH	81	COLLIN, Wundklammerzange	224
BUCK-GRAMCKO, Knochenhebel	285	chirurgische Pinzette, WAUGH	83	COLLIN, Zungenzange	453
BUJIE, Rektal-Absaugrohr	566	chirurgische Pinzette, ADSON	81/2, 82	COLLIN-DUVAL, Faßpinzette	85
Bulldogklemme, ATRAUMA	100	chirurgische Pinzette, ADSON-Micro	82	COLLIN-HARTMANN, Wundhaken	141
Bulldogklemme, DeBAKEY	103	chirurgische Pinzette, ADSON-BROWN	82	Columella-Pinzette, COTTLE	448
Bulldogklemme, GLOVER	103	chirurgische Pinzette, BONNEY	88	COLVER, Tonsillenfaßzange	467
Bulldogklemme, JOHNS-HOPKINS	104	chirurgische Pinzette, BROPHY	84	CONE, Schädelstanze	331
BÜLOW-GUNAR-HEY, Schlauchklemme	130	chirurgische Pinzette, CUSHING	83	CONNIN-AMSLER, Markierungsinstrument	380
BUMM, Uteruskürette	597, 598	chirurgische Pinzette, FERRIS-SMITH	85	CONVERSE, Nasenhaken	448
BUNELL, Handbohrapparat	299	chirurgische Pinzette, GILLIES	86	CONVERSE, Nasenmesser	435
BUNELL, Sehnenführer	294	chirurgische Pinzette, LANE	84	COOLEY, Aortadilatator	528
BUNELL, Sehenschäler	292	chirurgische Pinzette, USA	81/1	COOLEY, Katheterklemme	510
BUNGE, Exenterationslöffel	378	chirurgische Pinzette TC, OEHLER	81/1	COOLEY, Kinder-Gefäßklammen	522
BUNT, Sterilisierklammer	227, 624	chirurgische Pinzette, SEMKEN	86	COOLEY, Mehrzweck-Gefäßklemme	520
BURCH, Fixiergabel	373	chirurgische Pinzette, STILLE	81/1	COOLEY, Rippensperrrer	485, 487
BURKE, Uterus-Biopsiezange	590	chirurgische Pinzette, TAYLOR	87	COOLEY, Wundhaken	148
Bürstenspender	611	chirurgische Schere, IRIS	54	COOLEY-DERRA, Anastomosenklemme	519
BUSCH, Schere	64	chirurgische Schere, JOSEPH	54	COOLEY-NEONATAL, Rippensperrrer	485
BUSHE, scharfer Löffel	256	chirurgische Schere, KILNER	54	COOLY, Saugrohr	28
C		chirurgische Schere, REYNOLDS	54	COOPER, Unterbindungsnadel	219
CANFIELD, Tonsillennmesser	466	chirurgische Schere, SANVENERO	54	CORDES, Aufsatz	472
CAPLAN, Nasenzange	428	chirurgische Schere, STANDARD	51	CORONAL-BROW, Wundhaken	198
Cardiovascular-Klemme	526	chirurgische Schere, FERGUSSON	66	CORWIN-HEGAR, Drahtzange	319
CARMALT, Splitterpinzette	91	chirurgische Schere, METZENBAUM S	54	CORYLLOS, Rippenschere	480
CAROLL, Sehnenfaßinstrument	293	chirurgische Schere, SYSTRUNK	66	CORYLLOS, Wundhaken	166
Carotis-Shuntklemme, JAVID	511	Cilienpinzette, BARRAQUER	395	COS, Mikro-Ohrzängchen	414
CARPENTER, Tonsillenelevator	465	Cilienpinzette, BEER	395	COTTLE, Columella-Pinzette	448
CARPENTER, Tonsillennmesser	465	Cilienpinzette, DOUGLAS	395	COTTLE, Bulldogschere	56
Cartilageschere, MARTIN	65/1	Cilienpinzette, GRADLE	395	COTTLE, Fixierpinzette	410
CASPAR, Laminektomiespreizer	179, 180	Cilienpinzette, LITTAUER	395	COTTLE, Hammer	273
CASPAR, Spreizer	197	Cilienpinzette, REDA	395	COTTLE, Hauthäkchen	447/1, 448
		CINELLI, Septummeißel	441	COTTLE, Knorpelquetscher	440

COTTLE, Nasenhaken.....	447, 447/1	Darmquetschklemme, PAYR-BABY.....	548	DESJARDINS, Gallensteinlöffel.....	534
COTTLE, Nasenmesser.....	435	Darmschere.....	66	DESJARDINS, Gallensteinsonde.....	532
COTTLE, Nasenschere.....	59	Darmspatel.....	143	DESJARDINS, Gallensteinzange.....	531
COTTLE, Nasenspekula.....	423	Darmspatel, HABERER.....	143/1	DESMARRES, Chalazionspinzette.....	393
COTTLE, Osteotom.....	440	Darmspatel, KADER.....	143/1	DESMARRES, Wundhaken.....	151
COTTLE, Schere.....	56	Darmspatel, KÖRTE.....	143/1	DEUTSCHMANN, Starmesser.....	371
COTTLE, Septumelektor.....	439	Darmspatel, KÜMMEL.....	143/2	DeVILBISS, Schädelzange.....	332
COTTLE, Septummeißel.....	440	Darmspatel, LERICHE.....	143/2	Diagnostik-Besteck ECO "C".....	16
COTTLE-JOSEPH, Septumelektor.....	439	Darmspatel, REVERDIN.....	143/1	Diagnostik-Besteck ECO "T".....	16
COTTLE-KAZANJIAN, Knochensplitterzange.....	241	Darmspatel, RIBBON.....	143	Diagnostik-Besteck, RI-MINI.....	17
COTTLE-NEIVERT, Hauthäkchen.....	448	DARTIGUES, Uterusfußzange.....	585	Diagnostik-Besteck, UNI III.....	15
COXETER, Metallkatheter.....	555	DASTOOR, Strabismuspinzette.....	386	DIEFFENBACH, Gefäßklemme.....	104
CRAFOOD-SELLORS, Arterienklemme.....	119	DAUBENSPECK, scharfer Löffel.....	255	DIETER, Mikro-Ohrzängchen.....	414
CRAFOOD, Arterienklemme.....	118	DAVIDSON (SCAPULA), Wundhaken.....	166	DIETRICH, Aortaklemme.....	510
CRAFOOD, Lungenschere.....	65/2	DAVIEL, Starlöffel.....	377	DIETRICH, Gefäßschere.....	60
CREGO, Elevator.....	282	DAVIS, Duradissektor.....	332	DIETRICH, Mini-Bulldogklemme.....	101
CRILE, Arterienklemme.....	107	DAVIS, Fremdkörpernadel.....	374	Dilatationsbougie, DITTEL.....	554
CRILE, Nadelhalter.....	213	DAVIS, Sterilsierspinzette.....	227	Dilatationsbougie, GUYON.....	554
CRILE, Nervhaken.....	328	DAVIS-BOYLE, Mundsperrer.....	455	Dilatationsbougie, VAN BUREN.....	554
CRILE, Wundhaken.....	140	DAVIS-BOYLE, Sperrer.....	455	Dilatator, HANK.....	580
CRILE-MURRAY, Nadelhalter.....	209	DAVIS-BOYLE, Zugendrücker.....	455	Dilatator, HEGAR.....	578, 579
CRILE-RANKIN, Arterienklemme.....	107	DAVIS-MEYER, Mundsperrer.....	457	Dilatator, PRATT.....	580
CRILE-WOOD, Nadelhalter.....	209	DAY, Häkchen.....	409	DINGMANN, Elevator.....	463/3
CRITCHETT, Lidsperrer.....	370	DeBAKEY, Aorta-Aneurysmaklemme.....	496-498	DINGMANN, Knochenhaltezange.....	246
CRUTCHFIELD, Bohrer.....	327	DeBAKEY, Aortaklemme.....	499, 500	DINGMANN, Mundsperrer.....	456
CRUTCHFIELD, Schädelhalter.....	327	DeBAKEY, Bauchdeckenhalter.....	189/1	DINGMANN, Raspator.....	463, 463/3
CULLER, Irisspatel.....	378	DeBAKEY, Gefäßdilator.....	529	DINGMANN, Sperrer.....	456
CUSCO, Scheidenspekula.....	570, 571	DeBAKEY, Gefäßklemme.....	494-496	DIPLOMAT, Blutdruckmeßgerät.....	5
Cushing (TAYLOR), Pinzette TC.....	87	DeBAKEY, Ligaturklemme.....	499, 500	Dissektor, FISCH.....	420
CUSHING, anatomische Pinzette.....	83	DeBAKEY, Mehrzweck-Gefäßklemme.....	495, 508, 514-517	Dissektor, GORNEY.....	277
CUSHING, chirurgische Pinzette.....	83	DeBAKEY, Nadelhalter.....	210	Dissektor, PENFIELD.....	333
CUSHING, Bohrer.....	299	DeBAKEY, Saugrohr.....	28	Disziionsmesser, BOWMAN.....	372
CUSHING, Hirnspatel.....	336, 369	DeBAKEY, Tangentialklemme.....	502	Disziionsmesser, BERENS.....	372
CUSHING, Laminektomiezeange.....	349	DeBAKEY-SATINSKY, Tangentialklemme.....	502	Disziionsmesser, CASTROVIEJO.....	372
CUSHING, Nervenhaken.....	328	DE BOER, Rippensperrer.....	486	Disziionsmesser, GRAEFFE.....	372
CUSHING, Pinzette.....	87	DE LEE, Geburtszange.....	602	Disziionsmesser, WHEELER.....	373
CUSHING, Wundhaken.....	151, 152	DE MARTEL, Führungsinstrument.....	330	Disziionsmesser, ZIEGLER.....	373
CUZZI, Abortuslöffel.....	606	DE MARTEL-WOLFSON, Anastomosenklemme.....	546	Disziionsnadel.....	374
Cystotom, BECKER.....	375	DE MARTEL-WOLFSON, Darmklemme.....	546	Disziionsnadel, BOWMAN.....	374
Cystotom, GRAEFFE.....	375	DE MARTEL-WOLFSON, Klemmenhalterung.....	546	DITTEL, Dilatationsbougie.....	554
CZERNY, Hakenzange.....	584	DE MARTEL-WOLFSON, Klemmenschießzange.....	546	DIX, Fremdkörperflachmeißel.....	374
CZERNY, Mastdarm-Spekula.....	559	DEAN, Irlmesser.....	372	DIX, Fremdkörperinstrument.....	380
D		DEAN, Tonsillenschere.....	59	Doppelkürette.....	612
DANDY, Arterienklemme.....	109	DEAVER, Präparierschere.....	52	Doppellöffel, VOLKMANN.....	257
DANDY, Nervenhaken.....	328	DEAVER, Wundhaken.....	145, 146	DOUGHTY, Zungenspatel.....	458
DARLING, Wundspreizer.....	178	DEAVER-GRIP, Wundhaken.....	146	DOUGLAS, Cilienpinzette.....	395
Darmfaßzange, DOYEN-BABY.....	540	DeBAKEY, Anastomosenklemme.....	505	DOUGLAS, Kieferhöhlentroktr.....	204
Darmfaßzange, LOCKWOOD-ALLIS.....	538	DeBAKEY, Atrauma-Bulldogklemme.....	103	DOUGLAS, Tonsillennmesser.....	466
Darmfaßzange, ALLIS.....	537	DeBAKEY, Atrauma-Pinzette.....	98	DOYEN, Bauchdeckenhalter.....	189/1
Darmfaßzange, ALLIS-ADAIR.....	537	DeBAKEY, Atrauma-Pinzette TC.....	99	DOYEN, Darmklemme.....	540
Darmfaßzange, ALLIS-BABY.....	537	DeBAKEY Atrauma-Pinzette TITAN.....	99	DOYEN, gynäkologische Schere.....	63
Darmfaßzange, ATRAUMA.....	539	DeBAKEY, Coarctationsklemme.....	507	DOYEN, Hohlsonde.....	199
Darmfaßzange, BABCOCK.....	539	DeBAKEY-BAHNSON, Aneurysmaklemme.....	506	DOYEN, Myomheber.....	594
Darmfaßzange, BOYS-ALLIS.....	538	DeBAKEY-DIETHRICH, Mini-Bulldogklemme.....	101	DOYEN, Raspator.....	278
Darmfaßzange, COLLIN.....	539	DeBAKEY-MOSQUITO, Atrauma-Arterienklemme.....	509	DOYEN, Scheidenspekula.....	574
Darmfaßzange, DUVAL.....	539	DeBAKEY-PEAN, Atrauma-Arterienklemme.....	513	DOYEN, Schere.....	63
Darmfaßzange, JUDD-ALLIS.....	538	DeBAKEY-RANKIN, Atrauma-Arterienklemme.....	512	DOYEN, Tuchklemme.....	133
Darmfaßzange, LITTLEWOOD.....	538	DEJERINE, Perkussionshammer.....	24	DOYEN, Uterus-Polypenzange.....	585
Darmfaßzange, THOMS-ALLIS.....	538	Dekapitationsshaken, BRAUN.....	607	DOYEN, Wundhaken.....	163
Darmfaßzange, WILLIAMS.....	539	DELEE, Scheidenspekula.....	574	DOYEN-BABY, Darmklemme.....	540
Darmklemme, BABY-KOCHER.....	540	DEMELE, Drahtspanninstrument.....	315	DOYEN-JANSEN (MOLT), Mundsperrer.....	454
Darmklemme, BRUNNER.....	543	DEMELE, Drahtumführungs-nadel.....	315	DOYEN-STILLE, Wundhaken.....	167
Darmklemme, DE MARTEL-WOLFSON.....	546	DENHART, Mundsperrer.....	454	Drahtfaßzange.....	316, 318
Darmklemme, DOYEN.....	540	DENIS-BROWNE, Bauchdeckenhalter.....	185	Drahtgeflecht.....	311
Darmklemme, FEHLAND.....	542	DERF, Nadelhalter.....	208	Drahtkeifzange.....	317, 318, 320
Darmklemme, HAYES.....	545	Dermatom, HUMBY.....	50	Drahtsäge, OLIVECRONA.....	332
Darmklemme, KOCHER.....	540	Dermatom, SCHINK.....	49	Drahtschere, UNIVERSAL.....	67
Darmklemme, MAYO-ROBSON.....	541	Dermatom, SILVER.....	50	Drahtspanninstrument, DEMEL.....	315
Darmklemme, RESANO.....	542	Dermatom, WATSON.....	50	Drahtspanninstrument, LOUÏE.....	315
Darmklemme, SCUDDER.....	541	DERRA, Anastomosenklemme.....	515	Drahtumführungs-nadel, DEMEL.....	315
Darmklemme, STONE-WATT.....	545	D'ERRICO, Nervwurzelhaken.....	329/2	Drahtvalven f. Bauchdeckenhalter.....	184
Darmquetschklemme, PAYR.....	548	DESCHAMPS, Unterbindungsnadel.....	218	Drahtzange TC, BERRY.....	319
		DESJARDINS, Arterienklemme.....	121	Drahtzange TC, CORWIN-HEGAR.....	319

Drahtzange TC, MAYO-HABERISSER	319	ERRICO, Bohrer	299	Fertigschläger, KUENTSCHER	321
Dreibackenspannfutter Handgriff	300	Ersatzklinge	49	Fiberglas-Lichtträger, KLEINSASSER	36
DUBOIS, gynäkologische Schere	63	Ersatzklinge, steril	50	Finger-Goniometer	25
DUPLAY, Hakenzange	582	Ersatzlämpchen	29, 30	Fingerringsäge, REDA	297
DUPLAY, Kornzange	134	Ersatzsägeblätter	230	Fingerringsäge, WALTON	297
DUPLEX, Stethoskop	23	ESMARCH, Gipsmesser	233	Fingersäge, LANGENBECK	296
DUPUY-WEISS, Tonsillennadel	466	ESMARCH, Staubinde	296	Fingerschützer, LANGENBECK	311
Dura-Dissektor, DAVIS	332	ESMARCH, Verbandschere	69/2	FINOCHIETTO, Bronchusklemme	490
Dura-Dissektor, FRAZIER	333	ETHICON, Cilpanlegezange	524, 525	FINOCHIETTO, Nadelhalter	211
Dura-Dissektor, HOEN	333	EYES, Tonsillenschürer	468	FINOCHIETTO, Rippensperrer	482, 484
Dura-Dissektor, HORSLEY	333	EXACTA, Blutdruckmeßgerät	8	FINOCHIETTO-BABY, Rippensperrer	482
Dura-Dissektor, MILLIGAN	332	Exenterationslöffel, BUNGE	378	FINOCHIETTO-BURFORD, Rippensperrer	483
Dura-Dissektor, OLIVECRONA	332	Extensionsbügel, BOEHLER	312	FINSEN, Wundhaken	168
Dura-Dissektor, SACHS	332	Extensionsbügel, KIRSCHNER	312	FISCH, Dissektor	420
Dura-Dissektor, TOENNIS	332	Extensionsbügel, KIRSCHNER US	312	FISCH, feines Häkchen	335
Dura-Dissektor, WOODSON	333	Extirpationsmeißel, ROLLET	374	FISCHER, Irispinzette	384
Dura-Haken, JACOBSON	335	Extraktor	322	FISH, Sonde	199
Dura-Messer, KOOS	335	Extraktionshaken	322	FISHER, Tonsillennmesser	466
Dura-Haken	335	Extraktionshaken, ARRUGA	375	Fistelhäkchen, EMMETT	594
Dura-Haken, ADSON	329	Extraktionshaken, I.U.D.	593	Fistelsonde, LOCKHART-MUMMERY	200
DURANTE, Fußpinzette	88	Extraktor, KUENTSCHER	322	Fistelsonde, PRATT	563
Dura-Schere, SCHMIEDEN-TAYLOR	65/1	F		Fixationspinzette, BARRAQUER	390
DUVAL, Darmfaßzange	539	Face-Lift-Schere, FREEMAN	74	Fixationspinzette, ELSCHNIG	389
DUVAL, Fußpinzette	85	Face-Lift-Schere, GORNEY	73	Fixationspinzette, GRAEFE	389
Dynamometer, COLLIN	25	Face-Lift-Schere, KAYE	73	Fixationspinzette, GREEN	390
E		Face-Lift-Schere, REES	73	Fixationspinzette, LESTER	389
ECHLIN, Hohlmeißelzange	240	Face-Lift-Schere, REES	73	Fixiergabel, BURCH	373
ECO "C" Diagnostik-Besteck	16	Fadengabel, REDA	221	Fixierpinzette, CASTROVIEJO	390
ECO "T" Diagnostik-Besteck	16	Fadengabel f. Tracheotomie	475	Fixierpinzette, COTTLE	410
EICKEN (KILLIAN), Spülkanüle	433	Fadenpinzette, McPHERSON	392	Fixierpinzette, GRAEFE	83
Ein- u. Ausschlaginstrumente	321	Fadenpinzette, Mod. TUEBINGEN	392	Fixierpinzette, KIRBY-ARTHUR	385
Einmal-Skalpelle, steril	43	Fadenpinzette, PAUFIQUE	392	Fixiervorrichtung, LEYLA	368/4
Einschläger, BENDER	322	Fadenschere, HEATH	66	Fixiervorrichtung, ROCHARD	186
Elektrode, monopolar	629	Fadenschere, LITTAUER	66	Flachbohrer, CUSHING	299
Elektrodenball-Koagulation	629	Fadenschere, NORTHBENT	66	Flachmeißel	259, 264, 267
Elektroden-Drahtschlinge	629	Fadenschere, SPENCER	66	Flachmeißel, HOKE	265
Elektroden-Koagulation	629	FANSLER, Proktoskop	564	Flachmeißel, ALEXANDER	259
Elektroden-Lanzette	629	FARABEUF, Knochenhaltezange	243	Flachmeißel, BRÜNNINGS-LUCAS	260
Elektroden-Nadel	629	FARABEUF, Raspator	274	Flachmeißel, HIBBS	265
Elektroden-Schlinge	628, 629	FARABEUF, Wundhaken	139	Flachmeißel, LEXER	263
Elevator, CHANDLER	282	FARABEUF-COLLIN, Raspator	274	Flachmeißel, PARTSCH	259
Elevator, ALDERDYCE	282	FARABEUF-LAMBOTTE, Knochenhaltezange	243	Flachmeißel, STILLE	260
Elevator, BOIES	277	FARRELL, Watteträger	203	Flachzange	316, 317
Elevator, CREGO	282	Fußpinzette	305	flexible Faßzange, SERPENTINE-GRASPER	593
Elevator, DINGMANN	463/3	Fußpinzette, COLLIN-DUVAL	85	flexible Hirnsattelhalter, LEYLA	368/2
Elevator, FREER	434	Fußpinzette, DURANTE	88	flexibler Spannarm, LEYLA	368/3
Elevator, KEY	282	Fußpinzette, DUVAL	85	FOERSTER, Irispinzette	383
Elevator, LEMPERT	420	Fußpinzette, LERCHE	83	FOERSTER, Tupferzange	136
Elevator, McDONALD	283	Fußpinzette, RUSS, MODELL	85	FOMON, Hauthäkchen	447/1
Elevator, MURPHY-LANE	283	Fußzange	316	FOMON, Nasenhaken	447/1
Elevator, SAYRE	281	Fußzange, SERPENTINE-GRASPER	593	FOMON, Nasenraspel	444
Elevator, WATSON-CHEYNE	283	Fußzange, MARTEL	110	FOMON, Nasenschere	58
Elevatoren	280	Fußzange, PRATT	110	FOMON, Raspator	277
ELLIOT, Geburtszange	602	Fußzange, WILLET-MARTEL	110	FOMON, Rhinoplastschere	65/1
ELLIS, Fremdkörperhohlmeißel	374	FAULKNER, Kürette	449	FOMON, Septummeißel	441
ELSCHING, Fixationspinzette	389	FAURE, Biopsiezange	588	FOMON, Nasenraspel TC	445
ELSCHING, Hornhautmesser	373	FAURE, Peritoneumklemme	123	FOX, Lupuskürette	608
ELSCHING, Kapselpinzette	391	FAVALORO, Gefäßschere	61	FRAENKEL, Aufsatz	472
ELSCHING, Zyklodialsysspätel	379	FEHLAND, Darmklemme	542	FRAENKEL, Kehlkopfpolypenzange	471
EMMETT, Fistelhäkchen	594	FEILCHENFELD, Splitterpinzette	91	FRANCIS, Fremdkörpernadel	374
Endarterektomie-Stripper	202	FELDHEIM, Knochenhalteklammer	249	FRANKLIN-SILVERMANN, Biopsiekanüle	206
Endernagel, STEINMANN	307, 308	FERGUSSON, chirurgische Schere	66	FRAZIER, Bauchdeckenhalter	181
Endoskopiekorb	623	FERGUSSON, Saugrohr	337	FRAZIER, Dura-Dissektor	333
Endospekula, KOGAN	577	FERGUSSON, Gallensteinlöffel	533	FRAZIER, Hauthäkchen	149
ENGEL, Gipszange	229	FERGUSSON, Hämorrhoidalklemme	109	FRAZIER, Punktionskanüle	337
Enukleations-Löffel, WELLS	378	FERGUSSON, Knochenhaltezange	243	FRAZIER/FERGUSSON, Saugrohr	337
Episiotomie-Schere, WALDMANN	64	FERGUSSON, Saugrohr	337	FREEMAN, Face-Lift-Schere	74
Episiotomie-Schere, BRAUN-STADLER	64	FERRIERA, Wundhaken	197	FREEMAN, Wundhaken	198
EPKER, Osteotome	464/2	FERRIS-SMITH, Laminektomiezange	343	FREER, Elevatorium	434
EPPENDORFER, Uterus-Biopsiezange	590	FERRIS-SMITH, chirurgische Pinzette	85	FREER, Hauthäkchen	448
ERBE, Verbindungskabel	633	FERRIS-SMITH-KERRISON, Bandscheibenstanze	344, 344/2	FREER, Mukosamesser	434
ERBE/SELECT, Verbindungskabel	633	FERRIS-SMITH-KERRISSON, zerlegbare Stanze	344/2	FREER, Nasenmesser	434
				FREER, Septumhohlmeißel	442/1

FREER, Septumlevator.....	437, 439	Geburtszange, SIMPSON.....	602	GOMMEL, mikro-chirurgische Pinzette.....	96
FREER, Septummeißel.....	439	Geburtszange, SIMPSON-BRAUN.....	602	GOMMEL, Mikro-Schere.....	80
FREER, Septummesser.....	434	Geburtszange, SIMPSON-LUIKART.....	603	Goniometer f. Finger.....	25
Fremdkörperflachmeißel, DIX.....	374	Geburtszange, TARNIER.....	604	Goniotomiemesser, SCHEIE.....	373
Fremdkörperhebel, BUCK.....	412	Geburtszange, WRIGLEY.....	602	Goniotomiemesser, BARKAN.....	373
Fremdkörperhebel, QUIRE.....	412	Geburtszangen.....	602 - 604	GOOD, Tonsillenschere.....	59
Fremdkörperhohlmeißel, ELLIS.....	374	Gefäßclip, BIEMER.....	361	GOODELL, Uterus-Dilatator.....	581
Fremdkörperhohlmeißel, WALTON.....	374	Gefäßclip, MEHDORN.....	362	GORNEY, Dissektor.....	277
Fremdkörperinstrument, DIX.....	380	Gefäßclip, MÜLLER.....	365	GORNEY, Face-Lift-Schere.....	73
Fremdkörperkurette, ALVIS.....	374	Gefäßclip, YASARGIL.....	345 - 356	GOSSET, Bauchdeckenhalter.....	181
Fremdkörpernadel.....	374	Gefäßdilator, DeBAKEY.....	529	GOURDET, Uteruslöffel.....	599
Fremdkörpernadel, DAVIS.....	374	Gefäßdissektor, ROBB.....	530	GRADLE, Cilienpinzette.....	395
Fremdkörpernadel, FRANCIS.....	374	Gefäßklemme, DeBAKEY.....	494- 496	GRADLE, Ophthalmologie-Schere.....	57
Fremdkörpernadel, LA FORCE.....	374	Gefäßklemme, DIEFFENBACH.....	104	GRAEFFE, Fixierpinzette.....	83
Fremdkörpernadel, LEVINSON.....	374	Gefäßklemme, LELAND-JONES.....	494	GRAEFFE, Hauthäkchen.....	149
Fremdkörperzängchen, HARTMANN.....	412	Gefäßklemme, POTTS.....	492, 493	GRAEFFE, Irispinzette.....	382
Fremdkörperzängchen, HARTMANN-HOFFMANN.....	412	Gefäßklemme, SATINSKY.....	491	GRAEFFE, Schere.....	56
Fremdkörperzängchen, HARTMANN-WULLSTEIN.....	412	Gefäßklemmen, atrauma.....	492 - 523, 526, 527	GRAEFFE, Schlielhaken.....	375
Fremdkörperzängchen, STRUEMPEL.....	412	Gefäßpinzette, ADLERKREUTZ.....	84	GRAEFFE, Starlöffel.....	377
Fremdkörperzange, MATHIEU.....	553/1	Gefäßpinzette, NELSON.....	89	GRAEFFE, Starmesser.....	371
FRENZEL, Nystagmusbrille.....	20	Gefäßpinzette, WANGENSTEEN.....	89	GRAEFFE, Cystotom.....	375
FRENZEL, Zungenspatel.....	451	Gefäßpinzette, STILLE-BARRAYA.....	88	GRAEFFE, Disziionsmesser.....	372
FRIEDMAN, Hohlmeißelzange.....	234	Gefäßschere, DeBAKEY.....	61	GRAEFFE, Fixationspinzette.....	389
FRIEDMAN-Mini, Hohlmeißelzange.....	234	Gefäßschere TC, DeBAKEY.....	60	GRAEFFE, Schlielhaken.....	375
FRIEDMANN, Spekula.....	577	Gefäßschere, DIETRICH.....	60	GRAEFFE, Lidsperrer.....	370
FRITSCH, Wundhaken.....	163	Gefäßschere, FAVALORO.....	61	GRAHAM, Nervhaken.....	329
FRYKHOLM, Hohlmeißelzange.....	240	Gefäßschere, KELLY.....	61	GRAIG, Septumzange.....	426
FUCHS, Kapselpinzette.....	391	Gefäßschere, KLINCKENBERG-LOTH.....	65/2	GRAVE, Scheidenspekula.....	570
FUCHSIG, Arterienklemme.....	113	Gefäßschere, POTTS-DE MARTEL.....	59	GRAY, Arterienklemme.....	121
Führungshohlsonde, KOENIG.....	221	Gefäßschere, POTTS-SMITH.....	61	GREEN, Fixationspinzette.....	390
Führungshohlsonde, KIRSCHNER.....	221	Gefäßschere, SATINSKY.....	65/2	GREEN, Hornhautdissektor.....	374
Führungshohlsonde, SCHMIEDEN-PAYR.....	221	Gefäß-Spülkanüle, SCHMID.....	338	GREEN, Muskelhäkchen.....	375
Führungshohlsonde, BRUNNER.....	221	GELPI, Bauchdeckenhalter.....	189/1, 189/2	GREEN, Wundhaken.....	160
Führungshohlsonde, PAYR.....	221	GELPI, Haken.....	193	GREEN-ARMYTAGE, Uteruszange.....	605
Führungshohlsonde, SCHMIEDEN.....	221	GEMINI, Arterienklemme.....	115	GREGORY, Profundaklemme.....	517
Führungshohlsonde, VIENNA.....	221	GERALD, anatomische Pinzette.....	86	GREVEN, Mikro-Ohrzängchen.....	414
Führungsinstrument, DE MARTEL.....	330	GERALD, chirurgische Pinzette.....	87	Griff allein f. Uterus-Biopsiezangen.....	591
Führungsnadel, REDON.....	207	GERSTER, Knochenhalteklammer.....	250	Griff f. Kehlkopfspiegel.....	473
Führungsspiß.....	321	GERZOG, Hammer.....	270	Griff f. SCHERBAK.....	575
G		Gewebefußpinzette, BROWN.....	83	Griff f. Stabinstrumente, Tracheotomie.....	475
Galeahaken, YASARGIL.....	330	Gewebefußpinzette, SINGLEY.....	88	Griff f. Meißel.....	266
GALLAHER, Antrumraspel.....	446	Gewebefußzange, CHAPUT.....	110	Griff f. Osteotome.....	266
Gallenblasenschere, THOREK.....	65/2	Gewebefußzange, COLLIN.....	110	Griff f. Skalpell.....	38 - 41
Gallengangdilator, BAKES.....	532	Gewebefußzange, TUFFIER.....	110	Griffe f. Skalpell Mini.....	41
Gallensteinlöffel, MOOR.....	532	Gewicht f. AUVARD.....	576	GROSS, Ohrlöffel.....	409
Gallensteinlöffel, DESJARDINS.....	534	Gewicht f. SCHERBAK.....	575	GROSS-MAIER, Kornzange.....	134
Gallensteinlöffel, FERGUSSON.....	533	GIERTZ-STILLE, Rippenschere.....	481	GRUBER, Ohrspekula.....	399
Gallensteinlöffel, LUER-KOERTE.....	533	GIGLI, Säge.....	332	GUILLEN, Saugraspatorium.....	433/1
Gallensteinlöffel, MAYO.....	534	GILL, Hornhautmesser.....	373	Gummibirne f. POLITZER.....	406
Gallensteinsonde, DESJARDINS.....	532	GILL, Irispinzette.....	384	Gumminge-Ligatur f. MC GIVNEY.....	568
Gallensteinsonde, MOYNIHAN.....	532	GILL-ARRUGA, Kapselpinzette.....	390	GUTHRIE, Hauthäkchen.....	149
Gallensteinsonde, MAYO.....	534	GILL-HESS, Irispinzette.....	384	GUYON, Arterienklemme.....	122
Gallensteinzange, BLAKE.....	531	GILLIES, chirurgische Pinzette.....	86	GUYON, Dilatationsbougie.....	554
Gallensteinzange, DESJARDINS.....	531	GILLIES, Hauthäkchen.....	448	GUYON, Katheter-Einführungsinstrument.....	554
Gallensteinzange, MIXTER.....	531	GILLIES, Nadelhalter.....	212	GUYON, Nierenklemme.....	122
Gallesteinzange, MAYO-BLAKE.....	531	GIL-VERNET, Wundhaken.....	152	GUYTON-LUNGSGAARD, Sklerotom.....	373
GASS, Häkchen.....	376	Gipsabreißzange, WOLFF.....	233	Gynäkologie-Schere, DOYEN.....	63
GAUSS, Kopfschwarte.....	605	Gipsmesser, ESMARCH.....	233	Gynäkologie-Schere, DUBOIS.....	63
Geburtslöffel, SELLHEIM.....	607	Gipsmesser, HOPKINS.....	233	Gynäkologie-Schere, SIEBOLD.....	62
Geburtszange, BARTON.....	603	Gipsmesser, REINER.....	233	Gynäkologie-Schere, SIMS.....	62
Geburtszange, BOERMA.....	604	Gipsmesser, WIGMORE.....	229	H	
Geburtszange, DE LEE.....	602	Gipssäge, elektrisch.....	230	HABERER, Darmspatel.....	143/1
Geburtszange, ELLIOT.....	602	Gipssäge, ENGEL.....	229	Hämorrhoidal-Klemme, FERGUSSON.....	109
Geburtszange, KIELLAND.....	602	Gipsschere, STILLE.....	229	Hämorrhoidal-Ligatur, MC GIVNEY.....	568
Geburtszange, KIELLAND-LUIKART.....	603	Gipsspreizer, REDA.....	232	HAGLUND-STILLE, Gipsspreizer.....	232
Geburtszange, LUIKART.....	603	Gipsspreizer, BEESON.....	232	HAGHT, Rippensperre.....	487
Geburtszange, McLEAN.....	603	Gipsspreizer, HAGLUND-STILLE.....	232	HAJEK, Hammer.....	273
Geburtszange, McLEAN-LUIKART.....	603	Gipsspreizer, HENNIG.....	232	HAJEK, Septummeißel.....	442/1
Geburtszange, McLEAN-TUCKER.....	603	GLOVER, Bulldogklemme.....	103	HAJEK-BALLENGER, Elevator.....	439
Geburtszange, McLEAN-TUCKER-LUIKART.....	603	GLOVER, Mehrzweckklemme.....	515, 518, 519	HAJEK-KÖFLER, Stanze.....	429, 431
Geburtszange, NAEGELE.....	602	GLUCK, Rippenschere.....	480	Häkchen, BARBARA.....	419
Geburtszange, PIPER.....	604	GOLETT, Wundhaken.....	141	Häkchen, CLAYMAN.....	376
		GOLDMANN-FOX, Zahnfleischschere.....	67		

Häkchen, DAY	409	Handgriff Dreibackenspannfutter	300	HIBBS, Osteotome	265
Häkchen, FISCH	335	Handgriff f. Stabinstrumente f. Tracheotomie	475	HIBBS, Wundhaken	164
Häkchen, GASS	376	Handwaschbürste	611	HILL-FERGUSON, Rektal-Spekulum	560
Häkchen, KUGLEN	376	HANK, Dilator	580	Hirnmesser	48
Häkchen, LUCAE	409	HANK, Uterus-Dilatator	580	Hirnspatel, CUSHING	336, 369
Häkchen, McGEE	419	HARGIS, Raspator	463/2	Hirnspatel, HEIFETZ	369
Häkchen, SHAMBAUGH	419	HARGIS, Unterkieferhaken	463, 463/6	Hirnspatel, OLIVECRONA	336
Häkchen, SINSKEY	376	HARGIS, Wundhaken	463	Hirnspatelhalter, LEYLA	368/2
Häkchen f. Tracheotomie	475	HARKEN, Aurikelklemme	503	HIRSCHMANN, Anuskop	562
Häkchen, WAGENER	409	HARMS, Sonde	381	HIRSCHMANN, Zyklodialysespatel	379
Haken, BALFOUR	193	HARRINGTON, Bronchusklemme	490	Handgriff f. NABATOFF	201
Haken, GELPI	193	HARRINGTON, Haken	193	Hochfrequenz-Chirurgie	628, 629
Haken, HARRINGTON	193	HARRINGTON, Wundhaken	147	HOEN, Dura-Dissektor	333
Haken, KELLY	193	HARRINGTON-PEMBERTON, Wundhaken	147	HOESEL, Nadelhalter	213
Haken, KIRSCHNER	185, 187	HARTMANN, Nasenzange	427	HOFFER, Wundhaken	465
Haken, SCOVILLE	196	HARTMANN, Arterienklemme	104	HOFFMANN, Schlauchklemme	624
Haken, SMELLIE	605	HARTMANN, Ohrzängchen	411	Hohlmeißel	259, 264
Haken, TAYLOR	196	HARTMANN, Fremdkörperzängchen	412	Hohlmeißel, PARTSCH	259
Haken, TESSIER	463/3	HARTMANN, Nasenspekula	422	Hohlmeißel, ALEXANDER	259
Hakenzange, BARRET	582	HARTMANN, Ohrkatheter	408	Hohlmeißel, COBB	262
Hakenzange, BRAUN	582	HARTMANN, Ohrspekula	399	Hohlmeißel, HIBBS	265
Hakenzange, CZERNY	584	HARTMANN, Polypenzange	424	Hohlmeißel, KILLIAN	442/1
Hakenzange, DUPLAY	582	HARTMANN, Spülkanüle	433	Hohlmeißel, LEXER	263
Hakenzange, HULKA	583	HARTMANN, Stimmgabel	403	Hohlmeißel, LEXER-Mini	263
Hakenzange, IOWA	584	HARTMANN, Zungendrucker	452	Hohlmeißel, NOVOTEX	264
Hakenzange, JACOBS	583	HARTMANN-HALLE, Nasenspekula	421	Hohlmeißel, SMITH-PETERSEN	261
Hakenzange, JARCHO	583	HARTMANN-HOFFMANN, Fremdkörperzängchen	412	Hohlmeißel, WEST	442/1
Hakenzange, MUSEUX	583	HARTMANN-WULLSTEIN, Fremdkörperzängchen	412	Hohlmeißel, ZIELKE	264
Hakenzange, PRATT	584	HAUGH, Mikro-Ohrzängchen	414	Hohlmeißel, STILLE	260
Hakenzange, SCHRÖDER	583	Hauthäkchen, COTTLE	447/1	Hohlmeißelzange, FRIEDMAN	234
Hakenzange, SCHRÖDER	584	Hauthäkchen, COTTLE-NEIVERT	448	Hohlmeißelzange, ADSON	236
Hakenzange, SCHRÖDER (POZZI)	582	Hauthäkchen, FOMON	447/1	Hohlmeißelzange, BANE-HARTMANN	237
Hakenzange, SKENE	582	Hauthäkchen, FRAZIER	149	Hohlmeißelzange, BLUMENTHAL	236
Hakenzange, STAUDE-MOORE	582	Hauthäkchen, FREER	448	Hohlmeißelzange, BOEHLER	238
Hakenzange, TEALE	583	Hauthäkchen, GILLIES	448	Hohlmeißelzange, CLEVELAND	235
HALLE, scharfer Löffel	253	Hauthäkchen, GRAEFE	149	Hohlmeißelzange, ECHLIN	240
HALLE, Septumelelevator	437	Hauthäkchen, GUTHRIE	149	Hohlmeißelzange, FRIEDMAN-Micro	234
Halogenlampe	29	Hauthäkchen, JOSEPH	149	Hohlmeißelzange, FRIEDMAN-Mini	234
HALSEY, Nadelhalter	208	Hauthäkchen, KILNER	608	Hohlmeißelzange, FRYKHOLM	240
HALSTED-MOSQUITO, Arterienklemme	105	Hauthäkchen, KLEINERT-KUTZ	149	Hohlmeißelzange, JANSEN	237
Halteam f. LEYLA	368/1	Hauthäkchen, REDA	150	Hohlmeißelzange, KLEINERT-KUTZ	237
Halteklemme, ADSON	298	Hautschere	610	Hohlmeißelzange, LEMPERT	237
Halter für Hirnspatel, LEYLA	368/4	Haut-Trephinen, KEYE	608	Hohlmeißelzange, LUER	236
Halter, KALLMORGEN	573	HAYES, Darmklemme	545	Hohlmeißelzange, MARQUARDT	239
Halter, KRISTTELLER	572	HAYES, Rektum-Anastosenklemme	545	Hohlmeißelzange, MAYFIELD	238
Halterahmen	187	HEANEY, Hysterektomieklammer	126	Hohlmeißelzange, MEAD	235
Hammer	270, 271, 273	HEANEY, Nadelhalter	210	Hohlmeißelzange, OLIVECRONA	237
Hammer, BERGMANN	272	HEANY, Biopsiekurette	587	Hohlmeißelzange, RUSKIN	239
Hammer, COLLIN	270	HEANY, Wundhaken	164	Hohlmeißelzange, SAUERBRUCH	240
Hammer, COTTLE	273	HEANY-BALLENTINE, Hysterektomieklammer	127	Hohlmeißelzange, SCAGLIETTI	240
Hammer, GERZOG	270	HEATH, Fadenschere	66	Hohlmeißelzange, SEMB	240
Hammer, HAJEK	273	HEATH, Hammer	273	Hohlmeißelzange, SMITH-PETERSEN	238
Hammer, HEATH	273	HEBRA, Chalazionskurette	377	Hohlmeißelzange, STELLBRINK	234
Hammer, KIRK	270	HEGAR, Uterus-Dilatator	578, 579	Hohlmeißelzange, ZAUFAL-JANSEN	238
Hammer, LUCAE	271	HEGENBARTH, Wundklammerpinzette	224	Hohlmeißelzange, LEKSELL (STILLE)	240
Hammer m. Ferrozellgriff	272	HEIFETZ, Hirnspatel	369	Hohlmeißelzange, STILLE-LUER	239
Hammer, MEAD	271	HEIMING, Nierensteinzange	536	Hohlmeißelzange, STILLE-RUSKIN	239
Hammer, OMBREDANNE	273	HEISS, Arterienklemme	112	Hohlsonde	199
Hammer, PARTSCH	271	HEISTER, Mundsperrer	454	Hohlsonde, BRODIE	199
Hammer, QUISLING	271	HENKE, Tonsillenelevator	465	Hohlsonde, DOYEN	199
Hammer, WILLIGER	271	HENLEY, Wundspreizer	170	Hohlsonde, NELATON	199
Hämorrhoidal-Ligator	568	HENNIG, Gipsspreizer	232	HOHMANN, Knochenhebel	284, 285
Hämorrhoidal-Ligator, RUDD	568	HEPP-SCHIEDL, Mikro-Schere	78	HOHMANN-Mini, Knochenhebel	286
Hämorrhoidal-Zange, MC GIVNEY	568	HERRICK, Nierenstielklemme	123	HOKE, Flachmeißel	265
Hämorrhoidal-Zange, HEYWOOD-SMITH	567	HESS, Irispinzette	384	HOKE, Osteotome	265
Handbohrapparat, MOORE	298	HESS, Kapselpinzette	391	HOLINGER, OP-Laryngoskop	37
Handbohrapparat, BUNELL	299	HESS, Nervwurzelhaken	329/1	HOLLINGER, Lichtträger	37
Handbohrapparat, HUDSON	299	HEYMANN, Nasenschere	58	HOLSHER, Nervwurzelhaken	329/1
Handbohrapparat, KIRSCHNER	299	HEYMANN, Septumzange	425	HOLTH, Kapselstanze	380
Handbohrapparat, RALK	300	HEYMANN-KNIGHT, Polypenzange	425	HOLZBACH, Hysterektomieklammer	126
Handbohrapparat, REDA	300	HEYWOOD-SMITH, Hämorrhoidalzange	567	HOLZHEIMER, Wundhaken	168
Handbohrapparat, STILLE	298	HIBBS, Flachmeißel	265	HOPKINS, Gipsmesser	233
Handgriff	300	HIBBS, Hohlmeißel	265	HORGAN, Valve f. Bauchdeckenhalter	183

HORIZON, Clipanlegezange.....	524, 525	Irisspatel, WECKER.....	378	Kapsel­faß­zange, MILLIN.....	550, 551
Hornhautdissektor, GREEN.....	374, 375	ISRAEL, Wundhaken.....	162	Kapsel­pin­zette, ARRUGA.....	391
Hornhautdissektor, PATON.....	373	ITERSON, Trachealhaken.....	477	Kapsel­pin­zette, CASTROVIEJO.....	391
Hornhautmesser, ELSCHNIG.....	373	IVES-FANSLER, Anuskop.....	562	Kapsel­pin­zette, ELSCHNIG.....	391
Hornhautmesser, GILL.....	373	IWANSON, Meißgerät.....	624	Kapsel­pin­zette, FUCHS.....	391
Hornhautmesser, SATO.....	373			Kapsel­pin­zette, GILL-ARRUGA.....	390
Hornhautmesser, TOOK.....	373	J		Kapsel­pin­zette, HESS.....	391
Hornhautschaber, KUHN.....	373	JACKSON-BURROWS, Bauchdeckenhalter.....	189/2	Kapsel­pin­zette, KALT.....	391
Hornhautschere, CASTROVIEJO.....	79	JACKSON, Kehlkopf­pin­zette.....	471	Kapsel­pin­zette, SCHWEIGGER.....	391
HORSLEY, Dura-Dissektor.....	333	JACKSON, Laryngoskop.....	37	Kapsel­pin­zette, TERSON.....	391
HÖSEL, Wundhaken.....	167	JACKSON, Pinzette.....	471	Kapselschere, RESANO.....	53/2
HOUSE, Kürette.....	420	JACKSON, Scheidenspekula.....	573	Kapsel­stan­ze, HOLTH.....	380
HOUSE, Mikro-Meißsonde.....	420	JACKSON, Sehnen­faß­zange.....	292	Kathetereinführungsinstrument, GUYON.....	554
HOUSE, Saugrohr.....	337/2	JACKSON, Trachelhaken.....	476	Kathetereinführungzange, MAGILL.....	28
HOWARTH, Septum­ele­va­tor.....	438	JACOBS, Hakenzange.....	583	Katheterklemme, COOLEY.....	510
HUBER, Universalgriff.....	472	JACOBSON, Arterienklemme.....	105	KAYE, Face-Lift-Schere.....	73
HUDSON, Handbohrapparat.....	299	JACOBSON, Dura-Haken.....	335	Kegel f. SCHULTZE Salpingograph.....	596
HUDSON, T-Handgriff.....	300	JACOBSON, Knopfsonde.....	335	Keil­deckel­halter, REICHERT.....	471
HULKA, Hakenzange.....	583	JACOBSON, Nadelhalter.....	215	Kehlkopfkanüle.....	470
HUMBY, Dermatom.....	50	JACOBSON, scharfer Löffel.....	257	Kehlkopf­pin­zette, JACKSON.....	471
HUNTER, Splitter­pin­zette.....	465	JAEGER, Lanzenmesser.....	372	Kehlkopf­pol­pen­zange, FRAENKEL.....	471
HURD, Tonsillen-Dissektor.....	465	JAEGER, Lidplatte.....	371	Kehlkopf­pol­pen­zange, JURASZ.....	471
Hypophysenkürette.....	334	JAMESON, Schielhaken.....	375	Kehlkopfspiegel.....	473
Hypophysenzange.....	341	JAMESON, Strabismus­pin­zette.....	385	Kehlkopfspiegel, MICHEL.....	423
Hypophysen­pin­zette, ADSON.....	334	JANSEN, Hohlmeißelzange.....	237	Kehlkopfspiegel-Griff.....	473
Hypophysen­pin­zet­ten.....	334	JANSEN, Nasen­pin­zette.....	424	Kehlkopfspritze.....	470
Hysterektomisierschere, WERTHEIM.....	63	JANSEN, scharfer Löffel.....	257	KEINASSER, OP-Laryngoskop.....	35
Hysterektomie­klemme, HOLZBACH.....	126	JANSEN, Wundhaken.....	168	KEITH, Nadel.....	223
Hysterektomie­klemme, SEGOND-LANDAU.....	125	JANSEN-GRUENWALD, Nasen­pin­zette.....	424	KELLY, Anuskop.....	562, 563
Hysterektomie­klemme, HEANEY.....	126	JARCHO, Hakenzange.....	583	KELLY, Arterienklemme.....	106
Hysterektomie­klemme, HEANY-BALLEN­TINE.....	127	JAVID, Carotis-Shuntklemme.....	511	KELLY, Gefäßschere.....	61
Hysterektomie­klemme, ROGERS.....	127	JENNINGS, Mundsperrerr.....	454	KELLY-GRIP, Wundhaken.....	142
Hysterektomie­klemme, WERTHEIM.....	124, 128	JENSEN, Augenkanüle.....	394	KELLY, Proktoskop.....	563, 564
Hysterektomie­klemme, SEGOND.....	125	JOHNSON-HORNE, Watteträger.....	203	KELLY, Uterus-Polpenzange.....	585
		JOHNS-HOPKINS, Anlegezange.....	104	KELLY, Wundhaken.....	164, 193
I		JOHNS-HOPKINS, Arterienklemme.....	120	KELLY-RANKIN, Arterienklemme.....	106
I.U.D., Extraktionsshaken.....	593	JOHNS-HOPKINS, Bulldogklemme.....	104	Keratoplastik-Messer, BARRAQUER.....	373
Imbusschlüssel.....	231/3	JOHNSON, Nadelhalter.....	211	Keratoplastik-Messer PAUFIQUE.....	373
Impaktor.....	322	JONES, Tuckklemme.....	132	KERN, Knochenhalte­zange.....	244
INGE, Wirbelkörperspreizer.....	339	JONES-CLIP, Tuckklemme.....	132	KERRISON, Stanze.....	428
Injektionskanüle.....	36	JORGENSEN, Präparierschere.....	53	KEVORKIAN, Biopsiekürette.....	587
INSTRU-CARE, Instrumentenöl.....	634	JOSEF, Nasenmesser.....	434, 435	KEVORKIAN, Uterus-Biopsiezange.....	589, 591
Instrumente f. Tracheotomie.....	475	JOSEPH (LEWIS), Nasenraspel.....	443	KEVORKIAN-PACIFIC, Uterus-Biopsiezange.....	592
Instrumentenbox.....	617	JOSEPH, chirurgische Schere.....	54	KEY, Elevator.....	282
Instrumentenkasten.....	617	JOSEPH, Haut­häk­chen.....	149	KEYES, Trepheine.....	608
Instrumentenöl, INSTRU-CARE.....	634	JOSEPH, Nasenmesser.....	434	Kieferhöhlenstanze, HAJEK-KOFLER.....	429, 431
Insufflationskanüle, VERESS.....	206	JOSEPH, Nasenraspel.....	443	Kieferhöhlenstanze, KERRISON.....	428
Intraorale Retraktoren.....	463/1, 463/4	JOSEPH, Nasensäge.....	446	Kieferhöhlentrok­lar, COAKLEY.....	204
Inzisions­schere.....	52	JOSEPH, Raspator.....	277	Kieferhöhlentrok­lar, DOUGLAS.....	204
IOWA, Hakenzange.....	584	JOSEPH, Septum­ele­va­tor.....	437	Kieferhöhlentrok­lar, LICHTWITZ.....	204
IOWA, Nadelführer.....	206	JUDD-ALLIS, Darm­faß­zange.....	538	Kieferhöhlentrok­lar, PIERCE.....	204
IRIS, Schere.....	54	JUDD-MASSON, Blasenwund­sp­rei­zer.....	552	KIELLAND, Geburtszange.....	602
Irisschere, KNAPP.....	55	JUERS, Mikro-Ohr­z­äng­chen.....	414	KIELLAND-LUIKART, Geburtszange.....	603
Irisschere, LITTLER.....	55	JURASZ, Kehlkopf­pol­pen­zange.....	471	KILLIAN, Hohlmeißel.....	442/1
IRIS, Supercutschere.....	72	JURASZ, Zange.....	471	KILLIAN, Nasenspekula.....	423
Irishäkchen, O'CONNOR.....	375			KILLIAN, Septum­ele­va­tor.....	438, 439
Irishäkchen, WIENER.....	375	K		KILLIAN, Septumschere.....	471
Iris­mes­ser, DEAN.....	372	Kabel, bipolar.....	633	KILLIAN, Spükanüle.....	433, 433/1
Iris­mes­ser, KNAPP.....	372	KABERSKE, Pulverbläser.....	405	KILLIAN-CLAUS, Septumhohlmeißel.....	442/1
Iris­mes­ser, ZIEGLER.....	372	KADER, Bauch- u. Darm­sp­atel.....	143/1	KILNER, chirurgische Schere.....	54
Iris­pin­zette, BARRAQUER.....	384	KALLMORGEN, Halter.....	573	KILNER, Haut­häk­chen.....	608
Iris­pin­zette, BARRAQUER-KATZIN.....	384	KALLMORGEN, Scheidenspekula.....	573	KILNER, Nadelhalter.....	212
Iris­pin­zette, BISHOP-HARMAN.....	386	KALLMORGEN, Spekula.....	573	KILNER, Nasenhaken.....	447/1
Iris­pin­zette, BONN.....	387	KALT, Kapsel­pin­zette.....	391	KILNER, Supercutschere.....	72
Iris­pin­zette, FISCHER.....	384	KALT, Nadelhalter.....	214	KILNER-DOUGHTY, Mundsperrerr.....	456
Iris­pin­zette, FOERSTER.....	383	KALT-ARRUGA, Nadelhalter.....	214	Kinder-Atrauma-Gefäßklemme.....	526, 527
Iris­pin­zette, GILL.....	384	Kaltlichtklammer für Amnioskope.....	601	Kinder-Aortaklemme, SUBRAMANIAN.....	521
Iris­pin­zette, GILL-HESS.....	384	Kaltlichtträger, HOLLINGER.....	37	Kinder-Aortaklemme, SUBRAMANIAN-MINITURE.....	521
Iris­pin­zette, GRAEFE.....	382	Kaltlichtträger, JACKSON.....	37	Kinder-Gefäßklemme, SUBRAMANIAN.....	521
Iris­pin­zette, HESS.....	384	KANE, Nabelschnurklemme.....	605	Kinder-Gefäßklemme, SUBRAMANIAN-MINITURE.....	521
Iris­pin­zette, TROUTMAN.....	384	KANTROWITZ, Arterienklemme.....	119/1	Kinder-Gefäßklemmen.....	527
Iris­pin­zette, STEVENS.....	383	Kanüle f. Sauggriff ZÖLLNER u. WULLSTEIN.....	337/1	Kinder-Gefäßklemmen, atrauma.....	523
Irisspatel, CULLER.....	378	Kappenzange, REDA.....	615	Kinder-Gefäßklemmen, COOLEY.....	522

Langenmesser, JAEGER.....	372	LISTON, Amputationsmesser.....	44	MASING, Nasenhaken.....	447
Lärmtrommel, BARANY.....	405	LISTON, Knochensplitterzange.....	241	MASSING-NEIVERT, Nasenhaken.....	447
LARSEN, Sehnenfaßpinzette.....	292	LITTAUER, Cilienpinzette.....	395	MASSON, Nadelhalter.....	210
Laryngoskop-Kaltlichtgriff, Batteriegriff.....	33	LITTAUER, Fadenschere.....	66	Maßstab, Metall.....	25
Laryngoskop-Warmlicht, Batteriegriff.....	32	LITTAUER, Ohrzängchen.....	411	Mastdarm-Biopsiezange, TURREL.....	567
Laryngoskop-Warmlichtgriff mit Trafo-Anschluß.....	34	LITTAUER, Polypenzange.....	425	Mastdarm-Biopsiezange, YEOMAN.....	566, 567
Laryngoskop, HOLLINGER.....	37	LITTLE, Wundhaken.....	157	Mastdarm-Spekula, ALAN-PARKS.....	561
Laryngoskop, JACKSON.....	37	LITTLER, Irisschere.....	55	Mastdarm-Spekula, BARR.....	559
Laryngoskop, MILLER.....	30	LITTLEWOOD, Darmfaßzange.....	538	Mastdarm-Spekula, BODENHAMMER.....	559
Lateralspreizer.....	59	LOCKHART-MUMMERY, Fistelsonde.....	200	Mastdarm-Spekula, CZERNY.....	559
LAWRENCE, Arterienklemme.....	119	LOCKLIN, Zahnfleischschere.....	69	Mastdarm-Spekula, MATHIEU.....	560
LEBSCHKE, Sternummeißel.....	267	LOCKWOOD-ALLIS, Darmfaßzange.....	538	Mastdarm-Spekula, PRATT.....	559
LEES, Bronchusklemme.....	504	Löffelzängchen.....	416	Mastdarm-Spekula, SIMS.....	559
LEGUE, Blasenwundspreizer.....	553	LONDON-COLLEGE, Zahnpinzette.....	93	Mastdarm-Spekula, SCHULZE-BERGMANN.....	560
LEGUJEU, Blasenpatel.....	552	LOPEZ-REINKE, Tonsillen-Dissektor.....	465	MASTIN, Muskelklemme.....	479
LEKSELL (STILLE), Hohlmeißelzange.....	240	LORENZ, Verbandschere.....	70	MATHIEU, Fremdkörperzange.....	553/1
LELAND-JONES, Gefäßklemme.....	494	LORNA, Tuchklemme.....	133	MATHIEU, Mastdarmspekula.....	560
LEMPERT, Elevator.....	420	LOUTE, Drahtspanninstrument.....	315	MATHIEU, Nadelhalter.....	213
LEMPERT, Hohlmeißelzange.....	237	LOVE, Nervwurzelhaken.....	329/2, 330	MATHIEU, Wundhaken.....	141
LEMPERT, scharfer Löffel.....	256	LOVE, Wundhaken.....	465	MATHIEU-OLSEN, Nadelhalter.....	212
LERCHE, Faßpinzette.....	83	LOVE-GRUENWALD, Laminektomiezange.....	340	MATSON, Raspator.....	279
LERICHE, Arterienklemme.....	111	LOVELACE, Arterienklemme.....	109	MATSON-ALEXANDER, Raspator.....	279
LERICHE, Bauchspatel.....	143/2	LOVELACE, Lungenfaßzange.....	490	MAUNDER, Mundkeil.....	459
LERICHE, Darmspatel.....	143/2	LOWER, Arterienklemme.....	120	MAXI-GRASPER, Uterus-Biopsiezange.....	593
LESTER, Fixationspinzette.....	389	LOWMAN, Knochenhalteklammer.....	249	MAYFIELD, Hohlmeißelzange.....	238
LEVINSON, Fremdkörpernadel.....	374	LOWMAN-HOGLUND, Knochenhalteklammer.....	249	MAYO, Gallensteinlöffel.....	534
LEWIN, Knochenhaltezange.....	246	LUBET-BARBON, Nasentamponzange.....	424	MAYO, Gallenseinsonde.....	534
LEWIS, Nasenraspel.....	443	LUC, Septumzange.....	426	MAYO, Pinzette.....	89
LEXER-BABY, Präparierschere.....	53	LUCAE, Häkchen.....	409	MAYO, Präparierschere.....	52
LEXER, Flachmeißel.....	263	LUCAE, Hammer.....	271	MAYO, Sterilisierklammer.....	227, 624
LEXER, Hohlmeißel.....	263	LUCAE, Ohrpinzette.....	410	MAYO, Supercuttschere.....	71
LEXER-Mini, Hohlmeißel.....	263	LUCAE, Parazentese-Nadel.....	408	MAYO, Zungenspatel.....	451
LEXER, Präparierschere.....	53	LUCAE, Stimmgabel.....	404	MAYO-ADAMS, Wundspreizer.....	171
LEYLA, Retraktor-System.....	368	LUER, Hohlmeißelzange.....	236	MAYO-BLAKE, Gallensteinzange.....	531
LICHTENBERG, Nadelhalter.....	213	LUER, Trachealkanüle.....	479	MAYO-COLLINS, Wundhaken.....	141
Lichtleiterkabel-Siebkorb.....	623	LUER, Wundhaken.....	140	MAYO-HABERISSER, Drahtzange.....	319
Lichtträger.....	37	LUER-KOERTE, Gallensteinlöffel.....	533	MAYO-HEGAR, Nadelhalter.....	209
Lichtträger, JACKSON.....	37	Luftdusche, POLITZER.....	406	MAYON-GUYON, Arterienklemme.....	122
Lichtträger, HOLLINGER.....	37	Luftpumpe.....	295	MAYO-NOBLE, Präparierschere.....	52
LICHTWITZ, Kieferhöhlentroker.....	204	LUIKART, Geburtszange.....	603	MAY, Ophthalmoskop UNI II.....	14
LICHTWITZ, Punktionskanüle.....	433	LUIKART-BILL, Zughebel.....	604	MAYO-ROBSON, Darmklemme.....	541
Lidplatte, JAEGER.....	371	Lungenfaßzange, LOVELACE.....	490	MAYO-STILLE, Präparierschere.....	52
Lidsperre, BARRAQUER.....	370	Lungenschere, CRAFOORD.....	65/2	MAYO-STILLE, Supercuttschere.....	71
Lidsperre, BOWMAN.....	370	Lungenspatel.....	489	MC DONALD, Elevator.....	283
Lidsperre, CLARK.....	370	Lungenspatel, ALLISON.....	489	McGIVNEY, Hämorhoidal-Ligator.....	568
Lidsperre, CRITCHETT.....	370	LUNGSSGAARD, Sklerotom.....	373	McGIVNEY, Hämorhoidal-Zange.....	568
Lidsperre, MURDOCK.....	370	LUNIATSCHEK, Tamponstopfer.....	465	McINDOE, Knochensplitterzange.....	241
Lidsperre, SMITH.....	370	Lupuskürette, FOX.....	608	McKENZIE, Bohrer.....	299
Lidsperre, ARRUGA.....	370	Lupuskürette, PIFFARD.....	608	McCULLOUGH, Strabismuspinzette.....	385
Lidsperre, CASTROVIEJO.....	371	M.....		McGEE, Häkchen.....	419
Lidsperre, GRAEFE.....	370	Magen-Darmnähapparat, PETZ.....	549	McGEE, Mikro-Ohrzängchen.....	414
Lidsperre, LANCASTER.....	371	Magen-Darmklemme, MIKULICZ.....	543	McINDOE, Knorpelschere.....	65/1
Lidsperre, LIEBERMAN.....	371	Magenquetschklemme, LANE.....	547	McINDOE, Pinzette.....	85
Lidsperre, LISTER-BURCH.....	370	MAGIL, Katheterzange.....	28	McINTYRE, Augenkanüle.....	394
Lidsperre, MELLINGER.....	370	MAIER, Kornzange.....	134	McIVOR, Mundsperrler.....	457
Lidsperre, MELLINGER-AXENFELD.....	370	MALTZ (COTTLE), Nasenraspel.....	444	McKENTY, Septumlevator.....	437, 438
Lidsperre, MUELLER.....	371	MALTZ, Nasenraspel.....	443	McKENZIE, Anlegezange.....	326
Lidsperre, PARK.....	371	Mandrin f. RUMEL-BELMONT.....	528	McLEAN, Geburtszange.....	603
Lidsperre, STEVENSON.....	371	Manometer.....	295	McLEAN-LUIKART, Geburtszange.....	603
Lidsperre, WEEK.....	370	Manometer f. SCHULTZE.....	596	McLEAN-TUCKER, Geburtszange.....	603
Lidsperre, WILLIAMS.....	370	Markierungsinstrument, CONNIN-AMSLER.....	380	McLEAN-TUCKER-LUIKART, Geburtszange.....	603
Lidsperre, ZIEGLER.....	371	Markraumborner.....	322	McPHERSON, Fadenpinzette.....	392
LIEBERMAN, Lidsperre.....	371	MARQUARD, Hohlmeißelzange.....	239	MEAD, Hammer.....	271
Ligatur-Gummiringe f. MC GIVNEY.....	568	MARSCHIK, Tonsillenfaßpinzette.....	468	MEAD, Hohlmeißelzange.....	235
Ligaturklemme, DeBAKEY.....	499, 500	MARTEL, Faßzange.....	110	Medizinbecher.....	621
Linsenhaken, STEVENS.....	375	MARTIN, Beckenzirkel.....	605	Medizinlöffel.....	268, 621
Linsenmanipulator, BECHERT.....	379	MARTIN, Cartilageschere.....	65/1	MEEKER, Arterienklemme.....	119
Lippenhalter.....	453, 451	MARTIN, Knochenhaltezange.....	246	MEHDORN, Anlegepinzette.....	362
Lippenhalter, CAWOOD-MINNESOTA.....	451	MARTIN, Uterussonde.....	586	MEHDORN, Gefäßclip.....	362
LISTER (SINUS), Tupferzange.....	137	MARTIN, Verbindungskabel.....	633	Mehrzweck-Gefäßklemme.....	520
LISTER, Supercuttschere.....	72	MARTIN, Wundsperrler.....	175/1	Mehrzweck-Gefäßklemme, BAINBRIDGE.....	495
LISTER, Verbandschere.....	69/1	MARTINI, scharfer Löffel.....	257	Mehrzweck-Gefäßklemme, GLOVER.....	515, 518, 519
LISTER-BURCH, Lidsperre.....	370			Mehrzweck-Gefäßklemme, DeBAKEY.....	495, 508, 514 - 517

Mehrzweckschale.....	620	MILLIN, Prostatafaßzange.....	550, 551	Nabelschnurschere, MOD. USA.....	64
Meißel, BRUNETTI.....	268	Mini-Bulldogklemme, DeBAKEY-DIETHRICH	101	Nabelschnurschere, SCHUMACHER	64
Meißelklinge.....	266	Mini-Schnellkupplungshandgriff	301	Nadel, BARBARA	419
MELLINGER, Lidsperrerr	370	Mini-Skalpell	41	Nadel, ROSEN	419
MELLINGER-AXENFELD, Lidsperrerr	370	Mini-Skalpellgriffe.....	41	Nadel, REVERDIN.....	220
MENGHINI, Biopsiekaniüle	206	Mini-Bulldogklemme, DIETRICH	101	Nadel, YOUNG-BOOMERANG	220
Meniskushaken, BLOUNT	289	Mini-Bulldogklemmen, DeBAKEY-DIETHRICH	101	Nadeldose	615
Meniskusmesser, NEFF	292	MINI-LAMBOTTE, Flachmeißel	262	Nadelelektrode, monopolar	628, 629
Meniskusmesser, SMILLIE	292	MINI-TOWNSEND-DOWN, Biopsiezange	591	Nadelführer, IOWA	206
MERCEDES, Thoraxsperrerr	489	MINI-TOWNSEND-UP, Biopsiezange	591	Nadelführer, BARRAQUER	216, 217
MERIAM, Zahnpinzette	93	MIXTER, Arterienklemme S-gebogen	116	Nadelführer, BARRAQUER - TROUTMAN	216
Meßbecher	620	MIXTER, Gallensteinzange	531	Nadelführer, MICROVASCULAR	210
Messer, Amputation	44	MIXTER-BABY, Arterienklemme.....	119/1	Nadelführer, ADSON	211
Messer, Zwischenknochen	44	MIXTER-O'SHAUGNESSY, Arterienklemme	119/2	Nadelführer, ARRUGA	214
Messer, PLESTER.....	418	Mobilisierhaken, TESSIER.....	463/3	Nadelführer, BABY-WEBSTER	208
Messer, ROSEN	418	MOD. BONN, Nahtpinzette	387	Nadelführer, BAUMGARTNER	208
Messer, SCHUKNECHT.....	418	MOD. TÜBINGEN, Fadenpinzette	392	Nadelführer, BOYNTON	214
Messer, TABB	418	MOD. TÜBINGEN, Nahtpinzette	387	Nadelführer, BOZEMANN	211
Messer, WULLSTEIN.....	418	MOD. MÜNCHEN, Biopsiekürette	587	Nadelführer, BROWN	209
Meißgerät, IWANSON	624	MOD. VIENNA, Nasenspekula	421	Nadelführer, CASTROVIEJO	215, 216
Meißinstrumente.....	594	MOELTGEN, Winkelmesser	25	Nadelführer, CASTROVIEJO-Micro	215
Meißscheiber	26	MOGEN, Beschneidungsgerät	556	Nadelführer, CASTROVIEJO-Standard	216
Meißsonde, HOUSE	420	MOLLISON, Wundspreizer	171	Nadelführer, COLLIER	208
Messzirkel, CASTROVIEJO	380	MOLT, Rasatorium	276	Nadelführer, CRILE	213
Metallkatheter	555	Monopolare Elektrode	629	Nadelführer, CRILE-MURRAY	209
Metallkatheter, COXETER.....	555	MOOR, Gallensteinlöffel.....	532	Nadelführer, CRILE-WOOD	209
METZENBAUM, chirurgische Schere S	54	MOORE, Handbohrapparat	298	Nadelführer, DE BAKEY	210
METZENBAUM FINO, Präparierschere TC	53	MOORFIELD, Nahtpinzette	392	Nadelführer, DERF	208
METZENBAUM, Nadelhalter	211	MORGAN, Proktoskop	565	Nadelführer, FINOCHIETTO	211
METZENBAUM, Präparierschere	53/1	MORTIZ-SCHMIDT, Zungenspatel	452	Nadelführer, GILLIES	212
METZENBAUM, Supercuttschere	71	MORRIS, Wundhaken	164	Nadelführer, HALSEY	208
METZENBAUM, Präparierschere TC	53/1	MORRIS-DeBAKEY, Aortaklemme	506	Nadelführer, HEANEY	210
MEYERDING, Laminektomiespreizer	180	MORSE, Rippenspererr	484	Nadelführer, HOESSEL	213
MEYERDING, Wundhaken	157, 177	MORSE-FAVALORO, Rippenspererr	484	Nadelführer, JACOBSON	215
MEYERDING, Wundspreizer	180	MOYNIHAN, Arterienklemme	120	Nadelführer, JOHNSON	211
MEYHOEFER, Chalasionskürette	377	MOYNIHAN, Gallensteinsonde	532	Nadelführer, KALT	214
MICHEL, Kehlkopfspiegel	423	MOYNIHAN, Tuchklemme	133	Nadelführer, KALT-ARRUGA	214
MICHEL, Wundklammern.....	224	MUELLER, Lidsperrerr	371	Nadelführer, KILNER.....	212
MICHEL, Wundklammerpinzette	224	Mukosamesser, FREER	434	Nadelführer, LANGENBECK	213
MICHEL, Wundklammerzange	224	MÜLLER, Approximator	364	Nadelführer, LICHTENBERG	213
Micro-FRIEDMANN, Hohlmeißelzange.....	234	MÜLLER, Gefäßclip	365	Nadelführer, MASSON	210
Micro-HARTMANN, Arterienklemme.....	104	Mundkeil, MAUNDER	459	Nadelführer, MATHIEU	213
MICROVASCULAR, Nadelhalter.....	210	Mundsperrerr, DAVIS-MEYER	457	Nadelführer, MATHIEU-OLSEN	212
MIDDELDORPF, Wundhaken.....	160	Mundsperrerr, DAVIS-BOYLE	455	Nadelführer, MAYO-HEGAR	209
MIDDLETON-JANSEN, Septumzange	430	Mundsperrerr, DENHART	454	Nadelführer, METZENBAUM	211
mikro-chirurgische Pinzette	94	Mundsperrerr, DINGMANN	456	Nadelführer, NEIVERT	208
mikro-chirurgische Pinzette, GOMEL	96	Mundsperrerr, HEISTER.....	454	Nadelführer, OLSEN-HEGAR	212
Mikro-Faßzängchen, Rohrschaft	415	Mundsperrerr, JENNINGS	454	Nadelführer, RYDER.....	210
Mikro-Kanüle f. ZÖLLNER und WULLSTEIN Sauggriff	337/1	Mundsperrerr, KILNER-DOUGHTY	456	Nadelführer, SAROT	211
Mikro-Löffelzängchen, WULLSTEIN	416	Mundsperrerr, McIVOR	457	Nadelführer, STEVENS.....	214
Mikro-Löffelzängchen, Rohrschaft	416	Mundsperrerr, ROSER-KOENIG	454	Nadelführer, WANGENSTEEN	210
Mikro-Meßsonde, HOUSE.....	420	Mundsperrerr, DOYEN-JANSEN (MOLT)	454	Nadelführer, WEBSTER	208
Mikro-Ohrscherechen, BELLUCCI	413, 417	MURDOCK, Lidsperrerr	370	Nadelführer, BABY-OLSEN-HEGAR	212
Mikro-Ohrschere, SHEA	413	MURPHY, Wundhaken	156	Nadelführer, STRATTE	212
Mikro-Ohrzängchen	413 - 416	MURPHY-LANE, Elevator	283	Nadeln, chirurgische.....	222
Mikro-Ohrzängchen, COS	414	MUSEUX, Hakenzange.....	583	NAEGELE, Geburtszange.....	602
Mikro-Ohrzängchen, DIETER	414	Muskelhaken	267	Nagelausreisszange, RADOLF	297
Mikro-Ohrzängchen, GREVEN	414	Muskelklemme, MASTIN	479	Nagelfeile.....	610
Mikro-Ohrzängchen, HAUGH	414	Muskelpinzette, TROUTMAN	389	Nagelhautzange	610, 613
Mikro-Ohrzängchen, JUERS	414	Muskelpinzette, BERKE	389	Nagelscheren	609, 614
Mikro-Ohrzängchen, McGEE	414	Muskelpinzette, PRINCE	387	Nagel-Set	609
Mikro-Rohrschaftzange REDA	474	Muskelpinzette, SNELLEN	393	Nagelspaltzange, ANVIL	613
Mikro-Schere, GOMEL	80	Mutterschlüssel	313	Nagelsplitterinstrument	612/1
Mikro-Schere, HEPP-SCHUIDEL.....	78	MYLES, Nasenzange	427	Nagelzange, TURNBULL	609
MIKULICZ, Darmklemme	543	Myomheber, DOYEN	594	Nagelzangen	609, 612/2, 613, 614
MIKULICZ, Peritoneumklemme.....	123	Myommesser, SEGOND	594	NAGER, Tonsillennadel.....	466
MIKULICZ, Wundhaken.....	163	Myrtenblattschere	199	NAGER, Wundhaken	465
MIKULICZ-BABY, Peritoneumklemme	123	N		Nahtpinzette, CASTROVIEJO	392
MILLER, Laryngoskop	90	NABATOFF, Krampfadernbesteck	201	Nahtpinzette, MOD. BONN	387
MILLER, Nasenraspel	444	Nabelschnurklemme, COLLIN	605	Nahtpinzette, MOD. TUEBINGEN	387
MILLIGAN, Dura-Dissektor	332	Nabelschnurklemme, KANE	605	Nahtpinzette, MOORFIELD	392
MILLIN, Blasenperrerr	552, 553	Nabelschnurschere, BUSCH	64	Nahtpinzette, St. MARTIN	392
MILLIN, Kapselnaßpinzette	550, 551			Nasenfingelhaken, LANGE	448

Nasenhaken, CONVERSE	448	Neuro-chirurgische Schere.....	65	Opthalmoskop, MAY UNI II	14
Nasenhaken, AUFRICHT	447	Neuro-chirurgische Schere, STRULLY	65	OP-Laryngoskop, KLEINSASSER	35
Nasenhaken, COTTLE	447, 447/1	NEWS, Trachealhaken	477	OP-Laryngoskop, HOLINGER	37
Nasenhaken, FOMON	447/1	Nierenklemme, GUYON	122	OP-Laryngoskop, JACKSON	37
Nasenhaken, KILNER	447/1	Nierenschale	619	Organmesser	48
Nasenhaken, MASING	447	Nierensteinzange, HEIMING	536	Organ- und Gewebefäßzange, atrauma	111
Nasenhaken, MASING-NEIVERT	447	Nierensteinzange, RANDALL	535	oscillierende Gipsäge	230
Nasenmeißel, WEST	442/1	Nierensteinklemme, HERRICK	123	oscillierende Gipsäge mit Stababsauger	231
Nasennmesser, FREER	434	Nierenstiellklemme, WERTHEIM-CULLEN	125	Osteotom, MINI-LAMBOTTE	262
Nasennmesser, JOSEPH	434, 435	NISSEN, Arterienklemme	113	Osteotom, LAMBOTTE	261
Nasennmesser, CONVERSE	435	NORDFOLK/NORWICH, Wundspreizer	172	Osteotom, OBWEGESER	463, 464/1
Nasennmesser, COTTLE	435	NORTHBENT, Fadenschere	66	Osteotom, SMITH-PETERSEN	261
Nasenolive, POLITZER	406	NOTO, Uterus-Polypenzange	585	Osteotome	259, 464
Nasenpinzette, JANSEN	424	NOVAK, Biopsiekürlette	587	Osteotome, EPKER	464/2
Nasenpinzette, JANSEN-GRUENWALD	424	NOVOTEX, Hohlimeißel	264	Osteotome, HIBBS	265
Nasenpinzette, TROELTSCH	424	NOYES, Augenschere	75	Osteotome, LEXER	263
Nasenraspel, AUFRICHT	443	NOYES, Polypenzange	425	Osteotome, COTTLE	440
Nasenraspel, MILLER	444	Nystagmusbrille, FRENZEL	20	Osteotome, HOKE	265
Nasenraspel, PEET	446			Osteotome, STILLER	260
Nasenraspel, FOMON	444	O		Osteotomklinge	266
Nasenraspel, JOSEPH	443	Obduktions-Besteck	269	OSTROEM, Knochenstanze	430
Nasenraspel, JOSEPH (LEWIS)	443	Oberarmmanschette	295	O'SULLIVAN-O'CONNOR, Bauchdeckenhalter	181
Nasenraspel, LEWIS	443	Oberschenkelmanschette	295	O'SULLIVAN-O'CONNOR, Scheidenspekula	576
Nasenraspel, MALTZ	443	OBWEGESER, Ahle	463, 463/3	OTIS, Urethrotom	553
Nasenraspel, MALTZ (COTTLE)	444	OBWEGESER, Blattosteotom	464/1	Otoskop Diagnostik-Besteck, UNI I	13
Nasenraspel, WIENER	443	OBWEGESER, Osteotom	463, 464/1	OVERHOLT, Arterienklemme	114
Nasensäge, JOSEPH	446	OBWEGESER, Raspator	462	OVERHOLT-BABY, Arterienklemme	114
Nasenschere	429	OBWEGESER, Wundhaken	460, 461	OVERHOLT-GEISENDOERFER, Arterienklemme	114
Nasenschere, COTTLE	59	OCHSNER, Trokar	205	OVERHOLT-MIXTER, Arterienklemme	115
Nasenschere, FOMON	58	O'CONNOR, Iriskäpfchen	375		
Nasenschere, HEYMANN	58	OEHLER, chirurgische Pinzette	81/1	P	
Nasenspekula, COTTLE	423	Ohrhebel, ZAUFAL	409	Parametrium-Schere	63
Nasenspekula, HARTMANN	422	Ohrhebel, ZAUFAL-JANSEN	409	Parazentese-Nadel, LUCAE	408
Nasenspekula, HARTMANN-HALLE	421	Ohrkatheter, HARTMANN	408	Parazentese-Nadel, POLITZER	408
Nasenspekula, KILLIAN	423	Ohrkürette, BUCK	407	PARK, Lidsperrer	371
Nasenspekula, MOD.VIENNA	421	Ohrlöffel, GROSS	409	PARKER, Wundhaken	139
Nasenspekula, REDA	423	Ohrmesser, POLITZER	408	PARKER-LANGENBECK, Wundhaken	141
Nasenspekula, THUDICHUM	421	Ohrmesser, SEXTON	408	PARTSCH, Flachmeißel	259
Nasenspekula, TIECK-HALLE	423	Ohrpinzette JANSEN	424	PARTSCH, Hammer	271
Nasenspekula, VOLTOLINI	421	Ohrpinzette JANSEN-GRUENWALD	424	PARTSCH, Hohlimeißel	259
Nasentamponzange, LUBET-BARBON	424	Ohrpinzette TROELTSCH	424	PASSOW, Blutstillungsmeißel	260
Nasentamponzange, WESTMACOTT	424	Ohrpinzette, LUCAE	410	PATELLA, Knochenhaltezange	248
Nasenzange, CAPLAN	428	Ohrpinzette, TROELTSCH	410	PATON, Hornhautdissektor	373
Nasenzange, HARTMANN	427	Ohrpinzette, WILDE (TROELTSCH)	410	PAUFIQUE, Fadenpinzette	392
Nasenzange, MYLES	427	Ohrschlinge, BILLEAU	409	PAUFIQUE, Keratoplastik-Messer	373
Nasenzange, SCHMEDEN	427	Ohrschlinge, LANGENBECK	409	PAYR, Darmquetschklemme	548
Nasenzange, TAKAHASHI	427	Ohrschlinge, SHAPLEIGH	410	PAYR, Führungshohlsonde	221
Nasenzange, WATSON-WILLIAMS	428	Ohrsonde, STACKE	199	PAYR-BABY, Darmquetschklemme	548, 548
Nasenzange, WEIL-BLAKESLEY	426	Ohrspekula, RICHNAU-HOLMGREN	400	PEAN, Arterienklemme	108, 110
Nasenzange, STRUYCKEN	427	Ohrspekula, BOUCHERON	399	PECK-JOSEPH Präparierschere	74
NEFF, Meniskusmesser	292	Ohrspekula, BRUENINGS	401	PEDERSON, Scheidenspekula	570
NEGUS, Bruststütze	459	Ohrspekula, GRUBER	399	PENFIELD, Dissektor	333
NEGUS, Tonsillenzange	467	Ohrspekula, HARTMANN	399	PEERS, Tuckklemme	132
NEIVERT, Nadelhalter	208	Ohrspekula, POLITZER	399	PEET, Nasenraspel	446
NEIVERT-ANDERSON, Septummeißel	442	Ohrspekula, SIEGLE	402	PEET, Splitterzange	92
NELATON, Hohlsonde	199	Ohrspekula, TOYNBEE	399	PELKMANN, Tupferzange	137
NELSON, Gefäßpinzette	89	Ohrspekulahalter, LEYLA	368/3	Pelvis-Haken, St. MARKS	165
NELSON, Trokar	205	Ohrspritze, REINER	406	Penisklemme, STOCKMANN	553/1
NELSON, Unterbindungsnael	219	Ohrzängchen, HARTMANN	411	Penisklemme, STRAUSS	553/1
NEONATAL, Atramaklemme	523	Ohrzängchen, LITTAUER	411	PENNINGTON, Arterienklemme	109
Neonatal-Gefäßklemme, CASTANEDA	527	Ohrzängchen, TILLEY	411	PENNINGTON, Septum-elevator	438
Nervenhaken, CUSHING	328	OLDBERG, Laminektomie-Zange	341	PERCY, Retraktor	296
Nervhäkchen, KRAYENBUEHL	336	OLIVECRONA, Drahtsäge	332	Perforatorie, SMELLIE	607
Nervhaken, CRILE	328	OLIVECRONA, Dura-Dissektor	332	Peripherale-Gefäßklemme, DeBAKEY	494
Nervhaken, DANDY	328	OLIVECRONA, Hirnspatel	336	Peripherale-Gefäßklemme, LELAND-JONES	494
Nervhaken, GRAHAM	329	OLIVECRONA, Hohlimeißelzange	237	Peritoneumklemme, FAURE	123
Nervhaken, SACHS	329	OLIVECRONA-TOENNIS, Anlegezange	326	Peritoneumklemme, MIKULICZ	123
Nervhaken, SMITHWICK	329	OLLIER, Wundhaken	162	Peritoneumklemme, PHANEUF	123
Nervrädchen, WARTENBERG	25	OLSEN-HEGAR, Nadelhalter	212	PERKINS, Wundspreizer	168
Nerwurzelhaken, D'ERRICO	329/2	OMBREDANNE, Hammer	273	Perkussionshammer, BABINSKY	24
Nerwurzelhaken, HESS	329/1	Opthalmologie-Schere, GRADLE	57	Perkussionshammer, BERLINER	24
Nerwurzelhaken, LOVE	329/2, 330	Opthalmologie-Schere, AEBLI	58	Perkussionshammer, BUCK	24
Nerwurzelhaken, SCOVILLE	329/1, 330	Opthalmologie-Schere, STEVENS	58	Perkussionshammer, TAYLOR	24

Perkussionshammer, TROEMNER	24	Präparierschere, TOENNIS-ADSON.....	65	Raspator, OBWEGESER.....	462
PERTHES, Pfiem	304	Präparierschere, METZENBAUM FINO TC	53/1	Raspator, QUERVAIN	275
PESTALOZZA, Abortuskürette	606	Präparierschere, PECK-JOSEPH	74	Raspator, SEBILEAU	275
PETRI, Box	620	Präparierschere, MAYO-NOBLE.....	52	Raspator, SEDILLOT	274, 275
PETZ, Magen- und Darmnähapparat	549	PRATT, Dilatator	580	Raspator, SELDIN.....	277
Pfiem	304	PRATT, Faßzange	110	Raspator, SEMB	278
Pfiem, PERTHES.....	304	PRATT, Fistelsonde.....	563	Raspator, WILLIGER.....	276
Phalagenmesser	44	PRATT, Hakenzange	584	Raspatorium, MOLT	276
PHANEUF, Peritoneumklemme	123	PRATT, Mastdarm-Spekula	559	Rauchabsaugrohr, KLEINSASSER	36
PIERCE, Kieferhöhlentrokra	204	PRATT, Uterus-Dilatator	580	RECAMIER, Uteruskürette	597, 598
PIERCE, Septumellevator	438	PRECISA, Blutdruckmeßgerät	9	Recordspritze	596
PIFFARD, Lupuskürette	608	PRESBYTERIAN, Schlauchklemme	129	REDA, Amputationsmesser	44
PILLING, Cilpanlegezange	524, 525	PRICE-THOMAS, Bronchusklemme	490	REDA, Augenmagnet	395
PINARD, Stethoskop	23	PRINCE, Muskelpinzette	387	REDA, Cilienpinzette	395
Pinzette, anatomisch	81	PRINCE, Tonsillenschere	59	REDA EXCENTER, Verbandschere	69/2
Pinzette, bipolar	630 - 632	PROBE AND PACKER	612	REDA, Fadengabel	221
Pinzette, BONNEY.....	88	Profundaklemme, GREGORY	517	REDA, Fingerringsäge	297
Pinzette, DeBAKEY	98	Proktoskop, BENSAUDE	565	REDA, Gipsspreizer	232
Pinzette, JACKSON.....	471	Proktoskop, MORGAN	565	REDA, Handbohrapparat	300
Pinzette, MAYO	89	Proktoskop, CHELSEA-EATON	563	REDA, Hauthäkchen.....	150
Pinzette, STRASSBURGER MODELL	89	Proktoskop, FANSLER	564	REDA, Kappenzange	615
Pinzette, Uhrmacher.....	90	Proktoskop, HIRSCHMANN	563	REDA, Klängenbrecher	45
Pinzette, ULTRA-LIGHT.....	95	Proktoskop, IVES-FANSLER	563	REDA, Knochenhaltezange	246, 247
Pinzette, WAGENSTEEN	89	Proktoskop, KELLY	563, 564	REDA, Mikro-Rohrschaftzange	474
Pinzette, DAVIS	227	Prostatafaßzange, MILLIN	550, 551	REDA, Nasenspekulum	423
Pinzette, GOMEL	96	Prostatahaken, YOUNG	550	REDA, Organ- u. Gewebefaßzange, atrauma	111
Pinzette, YASARGIL	97	PROVIDENCE-HOSPITAL, Arterienklemme	106	REDA, scharfer Löffel	256
PIPER, Geburtszange	604	Pulverbläser, KABIBERSKE	405	REDA, Sichelmesser	435
Pistole f. Reinigung	626	Pulverbläser, UNIVERSAL	405	REDA, Watteträger	203
Plastik-Hammer	271	Pumpe f. Komprimierer	295	REDON, Führungsadel	207
Plazentabecken	621	Punktionskanüle, FRAZIER	337	REES, Face-Lift-Schere	73
PLESTER, Messer	418	Punktionskanüle, LICHTWITZ	433	Reibzähle	304
PLESTER, Saugrohr	338	PUTTI, Knochenraspel	294	REICHERT, Kehdeckelhalter	471
PLESTER, Wundspreizer	171	Pylorusspreizer, BENSON	544	REILL, Knochenhaltezange	248
POLITZER, Gummibirne.....	406	Q		REINER, Gipsmesser.....	233
POLITZER, Luftdusche.....	406	QUERVAIN, Elevator.....	275	REINER, Ohrspritze	406
POLITZER, Nasenolive	406	QUINBY, Zahnfleischschere	67	Reinigungsaufsatz	626
POLITZER, Ohrmesser	408	QUIRE, Fremdkörperhebel	412	Reinigungspistole.....	626
POLITZER, Ohrspekula	399	QUISLING, Hammer	271	Rektal-Absaugrohr, BUJE	566
POLITZER, Parazentese-Nadel	408	R		Rektal-Schnürer, WESTON.....	566
Polster f. Oberarm- u. Oberschenkelmanschette	295	Rachiotom	267	Rektal-Spekulum, SAWYER	560
Polypenschlinge	411	RADOLF, Nagelauseißzange	297	Rektal-Spekulum, HILL-FERGUSON	560
Polypenschnürer, KRAUSE-VOSS	433/2	Rahmen f. DENIS-BROWNE, Bauchdeckenhalter	185	Rektum-Anastosenklemme, HAYES	545
Polypenschnürer, KRAUSE	411, 433/2	Rahmen f. KIRSCHNER, Bauchdeckenhalter 185, 187, 187/1	185	Repositionszange, ROWE	459
Polypenschnürer, WILDE	411, 433/2	Rahmen f. O'SULLIVAN-O'CONNOR.....	576	RESANO, Darmklemme	542
Polypenzange, HEYMANN-KNIGHT	425	RALK, Handbohrapparat	300	RESANO, Kapselschere	53/2
Polypenzange, HARTMANN	424	RAMPLEY, Tupferzange.....	136	Resektionsmesser	47
Polypenzange, LITTAUER.....	425	RAMUS, Wundhaken.....	461	Retraktor, PERCY	296
Polypenzange, NOYES.....	425	RANDALL, Biopsiekürette	587	Retraktoren, Intraoral	463/1, 463/4
POOLE, Saugrohr	27	RANDALL, Nierensteinzange	535	Retraktor-System, LEVLA.....	368 - 368/4
POST MORTEM	269	RANEY, Klammeranlagezange	327	REVERDIN, Darmspatel	143/1
POTTS, Gefäßsklemme	492, 493	RANEY, Kopfhautklammern	327	REVERDIN, Nadel	220
POTTS, Anastomosen-Klemme	493	RANGELL, Wundhaken	140	REYNOLDS, chirurgische Schere	54
POTTS, Coarctations-Klemme	492	Rasierklingen	45	REYNOLDS, Supercuttschere	72
POTTS-SMITH, chirurgische Pinzette.....	81	Rasiermesser	49	Rhinoplastikschere, FOMON	65/1
POTTS-DE MARTEL, Gefäßschere	59	Raspator	279	RIBBON, Darmspatel	143
POTTS-SMITH, anatomische Pinzette.....	81	Raspator, ADSON.....	282	RICARD, Bauchdeckenhalter	191
POTTS-SMITH, Gefäßschere	61	Raspator, ALEXANDER	276	RICHARDSON, Wundhaken	142
Präparierschere	52	Raspator, COBB	280	RICHARDSON-EASTMAN, Wundhaken	142
Präparierschere, DEEVER	52	Raspator, DINGMANN	463, 463/3	RICHARDSON-GRIP, Wundhaken	142
Präparierschere, MAYO	52	Raspator, DOYEN	278	RICHNAU-HOLMGREN, Ohrspekula	400
Präparierschere, MAYO TC	52	Raspator, FARABEUF	274	RICHTER-HEATH, Wundklammerzange	224
Präparierschere, METZENBAUM	53/1	Raspator, FARABEUF-COLLIN	274	RIENHOFF-FINOCHIETTO, Rippensperrer	486
Präparierschere, WELLER.....	53/2	Raspator, FOMON.....	277	RIGBY, Bauchdeckenhalter	189/2
Präparierschere, JORGENSEN.....	53	Raspator, HARGIS.....	463/2	Ri-MINI, Diagnostik-Besteck.....	17
Präparierschere, LEXER.....	53	Raspator, JOSEPH	277	RING, Zungenspatel	455
Präparierschere, LEXER-BABY	53	Raspator, KOENIG.....	276	Ringmesser, BECKMANN	450
Präparierschere, LEXER-BABY TC	53	Raspator, LAMBOTTE	274	Ringmesser, LA FORCE	450
Präparierschere, METZENBAUM.....	53/1	Raspator, LANGENBECK	275	Ringmesser, St. CLAIR-THOMSON	450
Präparierschere, METZENBAUM FINO	53/1	Raspator, MATSON	279	Rippenkontraktor, BAILEY.....	489
Präparierschere, METZENBAUM TC	53/1	Raspator, MATSON-ALEXANDER	279	Rippenkontraktor, BAILEY-BABY	489
				Rippenkontraktor, BAILEY-GIBBON.....	489

Rippenschere, SAUERBRUCH-FREY	481	SAUERBRUCH, Abfallzange	227	Scheidenspekula, SCHERBAK	575
Rippenschere, BETHUNE	481	SAUERBRUCH, Hohlmeißelzange	240	SCHIEI, Goniotomiemesser	373
Rippenschere, BRUNNER	481	SAUERBRUCH, Rippenschere	481	SCHNEIMANN, Aufsatz	472
Rippenschere, CORYLLOS	480	SAUERBRUCH, Wundhaken	164, 166	SCHERBAK, Scheidenspekula	575
Rippenschere, GIERTZ-STILLE	481	SAUERBRUCH-FREY, Rippenschere	481	Schere, GORNEY	73
Rippenschere, GLUCK	480	Sauggriff, WULLSTEIN	338	Schere, MIKRO	76
Rippenschere, SAUERBRUCH	481	Saugraspatorium, GULEN	433/1	Schere, Neurochirurgie	65
Rippenschere, STILLE	480	Saugrohr	337/1	Schere, PARAMETRIUM	63
Rippensperrerr, COOLEY	485, 487	Saugrohr, FERGUSSON	337	Schere, REES	73
Rippensperrerr, COOLEY-NEONATAL	485	Saugrohr, ZÖLLNER	337/1	Schere, WAGNER	67
Rippensperrerr, DE BOER	486	Saugrohr, ADSON	337	Schere, CASTROVIEJO	79
Rippensperrerr, FINOCHIETTO	482, 484	Saugrohr, ANDREW-PYNCHON	28	Schere, DOYEN	63
Rippensperrerr, FINOCHIETTO-BABY	482	Saugrohr, BABY-YANKAUER	27	Schere, HEPP-SCHIEDEL	78
Rippensperrerr, FINOCHIETTO-BURFORD	483	Saugrohr, BARON	336	Schere, SIEBOLD	62
Rippensperrerr, HAIGHT	487	Saugrohr, COOLEY	28	Schere, SIMS	62
Rippensperrerr, MORSE	484	Saugrohr, DeBAKEY	28	Schere, THOREK	65/2
Rippensperrerr, MORSE-FAVALORO	484	Saugrohr, FRAZIER/FERGUSSON	337	Schieblehre, TOWNLEY	26
Rippensperrerr, RIENHOFF-FINOCHIETTO	486	Saugrohr, PLESTER	338	Schielhaken, GRAEFE	375
Rippensperrerr, TUFFIER	487	Saugrohr, POOLE	27	Schielhaken, JAMESON	375
RITTER-HALLE, Stirnhöhlerdilator	433	Saugrohr, ROSEN	338	Schildrüsenhaken, SCHOENBORN	479
ROBB, Gefäßdissektor	530	Saugrohr, YANKAUER	27	SCHIMMELBUSCH, Verbandstoffrommel	622
ROBB, Spatel	530	Saugrohr, YASARGIL	337/1	SCHINK, Dermatome	49
ROBERTS, Arterienklemme	117	Saugrohre, HOUSE	337/2	SCHIOETZ, Tonometer	394/2
ROCHARD, Bauchdeckenhalter	186	SAWTELL, Tonsillenzange	467	Schlauchhalterung	188
ROCHARD, Fixiervorrichtung	186	SAWYER, Rektal-Spekulum	560	Schlauchklemme, KLINIKUM BERLIN	129
ROCHESTER-CARMALT, Arterienklemme	109	SAYRE, Elevator	281	Schlauchklemme, PRESBYTERIAN	129
ROCHESTER-OCHSNER, Arterienklemme	108	SCAGLIETTI, Hohlmeißelzange	240	Schlauchklemme, HOFFMANN	624
ROCHESTER-PEAN, Arterienklemme	108	SCALP-CONTOUR, Wundspreizer	169	Schlauchklemme, SIMPLEX	624
ROEDER, Tuchklemme	132	Schädelhalter, CRUTCHFIELD	327	Schlauchklemme, BÜLOW-GUNAR-HEY	130
ROGER, Septumlevator	437	Schädelspalter	267	Schlauchklemmen	129
ROGERS, Hysterektomieklammer	127	Schädelstanze, CONE	331	Schlauchverbindungsstück	600
ROGGE, Sterilisierzange	227	SCHAEDEL, Tuchklemme	132	SCHLESINGER, Laminektomiezange	342
ROLLET, Extripationsmeißel	374	Schädelzange, DeVILBISS	332	Schließklemme, STONE	545
ROLLET, Tränensackhäkchen	375	Schaft	231/3	Schlinge f. Polypenschnürer	433/2
ROSE, Wundhaken	140	Schale	619	Schlüssel f. Meißel	266
ROSEN, Messer	418	Schälmesser, Tracheotomie	475	Schlüssel f. Osteotome	266
ROSEN, Nadel	419	SCHAMBERG, Komedonenquetscher	608	Schlüsselpaar f. Gipssäge und Autopsiesäge	230, 231/3
ROSEN, Saugrohr	338	Scharfer Löffel	255	SCHMEDEN, Nasenzange	427
ROSER-KOENIG, Mundsperrerr	454	Scharfer Löffel, BRUNS	251, 254	SCHMID, Gefäß- u. Spülkanüle	338
ROUX MINI, Wundhaken	140	Scharfer Löffel, BUSHE	256	SCHMIEDEN, Führungshohlsonde	221
ROUX, Wundhaken	139	Scharfer Löffel, COBB	252	SCHMIEDEN-DICK, Unterbindungsnadel	219
ROUX-BABY, Wundhaken	140	Scharfer Löffel, DAUBENSPECK	255	SCHMIEDEN-TAYLOR, Duraschere	65/1
ROWE, Repositionszange	459	Scharfer Löffel, HALLE	253	Schnellkupplungs-T-Handgriff	300, 301
RUBIN, Septummeißel	440	Scharfer Löffel, JACOBSON	257	Schnellkupplungs-Handgriff	301
RUBIN, Septumzange	428	Scharfer Löffel, JANSEN	257	SCHNIDT, Tonsillenzange	467
RUDD, Hämorrhoidal-Ligatur	568	Scharfer Löffel, LEMPERT	256	SCHOENBORN, Schilddrüsenhaken	479
RUMEL, Arterienklemme	117	Scharfer Löffel, MARTINI	257	Schraubenhaltehülse	324
RUMEL-BELMONT, Tourniquet	528	Scharfer Löffel, REDA	256	Schraubenhaltezange, LANE	325
RUSKIN, Hohlmeißelzange	239	Scharfer Löffel, SCHEDE	251	Schraubenzieher m. Ferrozellgriff	323
RUSKIN-LISTON, Knochensplitterzange	241	Scharfer Löffel, SCOVILLE	253	Schraubenzieher, WILLIAMS	323
RUSSEL-DAVIS, Zungenspatel	458	Scharfer Löffel, SPINAL	253	Schraubenzieher, LANE	323
RUSSISCHES MODELL, Fußpinzette	85	Scharfer Löffel, SPRATT	251	Schröder, Hakenzange	584
RYDEL-SEIFFERT, Stimmgabel	404	Scharfer Löffel, VOLKMANN	257	SCHRÖDER, Uteruslöffel	595
RYDER, Nadelhalter	210	Scharfer Löffel, WILLIGER	255, 257	SCHROEDER (POZZI), Hakenzange	582
S		SCHUDE, scharfer Löffel	251	SCHROEDER, Hakenzange	583
SAALFELD, Komedonenquetscher	608	Scheidenspekula	569 - 577	SCHUBERT, Biopsiezange	588
SACHS, Dura-Dissektor	332	Scheidenspekula, JACKSON	573	SCHUKNECHT, Messer	418
SACHS, Nervhaken	329	Scheidenspekula, AUVARD	576	SCHULTZE, Salpingograph	596
SAENGER, Abortuszange	606	Scheidenspekula, BREISKY	577	SCHULZE-BERGMANN, Mastdarm-Spekula	560
Säge, GIJLI	332	Scheidenspekula, COLLIN	570	SCHUMACHER, Aufsatz	472
Sägeblatt f. Fingerringssäge	297	Scheidenspekula, CUSCO	570, 571	SCHUMACHER, Biopsiezange	588
Sägeblätter	230	Scheidenspekula, DELEE	574	SCHUMACHER, Episotomieschere	64
Sägitalspreizer, SMITH	463/5	Scheidenspekula, DOYEN	574	SCHUMACHER, Sternumschere	481
Salpingograph, SCHULTZE	596	Scheidenspekula, GRAVE	570	SCHUMACHER, Uterus-Biopsiezange	589
SANVENERO, chirurgische Schere	54	Scheidenspekula, KALLMORGEN	573	Schüssel	619
SAROT, Arterienklemme	118	Scheidenspekula, KRISTELLER	572	SCHWEIGGER, Kapselpinzer	391
SAROT, Nadelhalter	211	Scheidenspekula, LANDAU	577	Schwingmesser, BALLENGER	436
SATINSKY, Gefäßklemme	491	Scheidenspekula, O'SULLIVAN-O'CONNOR	576	SCOVILLE, Haken	196
SATINSKY, Gefäßschere	65/2	Scheidenspekula, PEDERSON	570	SCOVILLE, Laminektomiespreizer	196
SATINSKY, Tangentialklemme	502	Scheidenspekula, SEMM	571	SCOVILLE, Nervwurzelhaken	329/1, 330
SATO, Hornhautmesser	373	Scheidenspekula, SIMS	573	SCOVILLE, scharfer Löffel	253
SATTERLEE, Amputationssäge	296	Scheidenspekula, TRELAT	571	SCOVILLE-HAVERFIELD, Laminektomiespreizer	196
		Scheidenspekula, VU-MORE	569	SCUDDER, Darmklemme	541

SEBILEAU, Raspator.....	275	SHAMBAUGH, Häkchen.....	419	Sonde, HARMS.....	381
SEDLLOT, Raspator.....	274, 275	SHAPLEIGH, Ohrschlinge.....	410	Sonde, MARTIN.....	586
Segmentsäge.....	231/2	SHEA, Mikro-Ohrschere.....	413	Sonde, SIMS.....	586
SEGOND, Hysterektomieklammer.....	125	SHEEHAN, Osteotom.....	441	Sonde, WATSON-CHEYNE.....	199
SEGOND, Myommesser.....	594	SHEEHAN, Septummeißel.....	441	Sonde, WORST.....	381
SEGOND-LANDAU, Hysterektomieklammer.....	125	SHEETS, Augenkanüle.....	394/2	Sonden.....	199
Sehnenfaßinstrument, BRAND.....	293	Sichelmesser, REDA.....	435	Sondenspitzen f. NABATOFF.....	201
Sehnenfaßinstrument, CAROLL.....	293	Sichelmesser, Tracheotomie.....	475	Spannarm, flexibel, LEYLA.....	368/3
Sehnenfaßinstrument, KLEINERT-KUTZ.....	294	SIEBENMANN, Spülkanüle.....	433/1	Spannplatte.....	49
Sehnenfaßpinzette, LARSEN.....	292	Siebkorb für Endoskope u. Lichtleiterkabel.....	623	Spannschlüssel.....	313
Sehnenfaßzange.....	293	Siebkorbdeckel.....	623	Spatel.....	203, 612/1
Sehnenfaßzange, JACKSON.....	292	SIEBOLD, gynäkologische Schere.....	62	Spatel, ROBB.....	530
Sehnenführer, BUNELL.....	294	Siebschale, perforiertes Blech.....	623	SPATULA AND PACKER.....	612
Sehnenhaltezange, STEINMANN.....	292	SIEGLE, Ohrspekula.....	402	Spekula, FRIEDMANN.....	577
Sehenschäler, BRAND.....	294	Silberklammern.....	326	Spekula, KALLMORGEN.....	573
Sehenschäler, BUNNELL.....	292	Silikoneinlage f. DAVIS-BOYLE.....	455	Spekula, KRISTELLER.....	572
SEIFERT, Aufsatz.....	472	Silikonmatte.....	616	SPENCER, Fadenschere.....	66
Sektionsnadel.....	268	Silikonschlauch f. McIVOR.....	457	SPENCER-WELLS, Arterienklammer.....	109
SELDIN, Raspator.....	277	SILVER, Dermatome.....	50	Sperrer, DAVIS-BOYLE.....	455
SELECT, Verbindungskabel.....	633	SILVER, Septummeißel.....	442	Sperrer, DINGMANN.....	456
SELLHEIM, Geburtsöffel.....	607	SIMCOE, Spülkanüle.....	394/2	Sperrer, KILNER-DOUGHTY.....	456
SEMB, Bronchusklammer.....	491	SIMON, Uteruslöffel.....	594	Spinalhaken, TAYLOR.....	291
SEMB, Hohlmeißelzange.....	240	SIMON, Wundhaken.....	164	SPINAL, scharfer Löffel.....	253
SEMB, Knochenhaltezange.....	243	SIMPLEX, Schlauchklammer.....	624	SPINA-NASALIS, Wundhaken.....	461
SEMB, Knochen splitterzange.....	242	SIMPSON, Geburtszange.....	602	Spiralbohrer.....	302
SEMB, Raspator.....	278	SIMPSON-BRAUN, Geburtszange.....	602	Spitze f. YANKAUER Saugrohr.....	27
SEMKEN, anatomische Pinzette.....	86	SIMPSON-LUIKART, Geburtszange.....	603	Splitterpinzette.....	91
SEMKEN, chirurgische Pinzette.....	86	SIMS, gynäkologische Schere.....	62	Splitterpinzette, CARMALT.....	91
SEMM, Scheidenspekula.....	571	SIMS, Mastdarm-Spekula.....	559	Splitterpinzette, FEILCHENFELD.....	91
SENN-GREEN, Wundhaken.....	153	SIMS, Scheidenspekula.....	573	Splitterpinzette, HUNTER.....	91
SENN-MILLER, Wundhaken.....	143	SIMS, Sonde.....	586	Splitterzange, ARCHER.....	92
Septemzange, KNIGHT.....	425	SIMS, Uterus-Dilatator.....	581	Splitterzange, PEET.....	92
Septemzange, HEYMANN.....	425	SIMS, Uterus-Depressor.....	586	Splitterzange, VIRTUS (RALK).....	92
Septumhohlmeißel, FREER.....	442/1	SIMS, Uteruskürette.....	597, 598	Splitterzange, STIEGLITZ.....	92
Septumhohlmeißel, HAJEK.....	442/1	SIMS, Uterussonde.....	586	SPRATT, scharfer Löffel.....	251
Septumhohlmeißel, KILLIAN-CLAUS.....	442/1	SIMS-MAIER, Kornzange.....	134	Spreizer, SMITH.....	463/5
Septummosteotom, SHEEHAN.....	441	SINGLEY, Gewebefäßpinzette.....	88	Spritzen.....	407
Septummosteotome, CINELLI.....	441	SINOSKOPIE-TROKAR.....	205	Spül- u. Saugkanüle, BISHOP-HARMON.....	394/1
Septummosteotome, FOMON.....	441	SINSKEY, Häkchen.....	376	Spülkanüle, KILLIAN.....	433, 433/1
Septumelevator, FREER.....	437, 439	SINUS, Septumelevator.....	438	Spülkanüle, EICKEN (KILLIAN).....	433
Septumelevator, HOWARTH.....	438	Sinuskopie-Zange.....	431	Spülkanüle, HARTMANN.....	433
Septumelevator, McKENTY.....	437, 438	Skalpelle Mini.....	41	Spülkanüle, SIEBENMANN.....	433/1
Septumelevator, BALLENGER.....	439	Skalpelle mit Metallheft.....	46	Spülkanüle, SIMCOE.....	394/2
Septumelevator, COTTLE.....	439	Skalpelle, steril.....	43	SPURLING, Laminektomie zange.....	340
Septumelevator, COTTLE-JOSEPH.....	439	Skalpelligriff.....	38 - 42	Sputumbecher.....	621
Septumelevator, HAJEK-BALLENGER.....	439	Skalpelligriff Mini.....	41	St. CLAIR-THOMSON, Ringmesser.....	450
Septumelevator, HALLE.....	437	Skalpelligklingen.....	42	St. MARKS-PELVIS, Haken.....	165
Septumelevator, JOSEPH.....	437	Skalpelligklingen-Entferner.....	42	St. MARKS, Wundhaken.....	165
Septumelevator, KILLIAN.....	438, 439	SKENE, Hakenzange.....	582	St. MARTIN, Nahtpinzette.....	392
Septumelevator, PENNINGTON.....	438	Sklerotom, GUYTON-LUNDSGAARD.....	373	STACKE, Ohrsonde.....	199
Septumelevator, PIERCE.....	438	Sklerotom, LUNDSGAARD.....	373	STAMM, Knochen splitterzange.....	241
Septumelevator, ROGER.....	437	SLS, Clipanlagezange.....	524, 525	Standard, chirurgische Schere.....	51
Septumelevator, SINUS.....	438	SLUDER-BALLENGER, Tonsillotom.....	470	STANDARD (NELSON), Trokar.....	204
Septummeißel, CINELLI.....	441	SMELLIE, Haken.....	605	Standgefäß.....	620
Septummeißel, COTTLE.....	440	SMELLIE, Perforatorie.....	607	Stanze, COLCLOUGH.....	344/1
Septummeißel, FOMON.....	441	SMILIE, Meniskusmesser.....	292	Stanze, FERRIS-SMITH-KERRISON.....	344
Septummeißel, FREER.....	439	SMILLIE, Knochenhebel.....	291	Stanze, ÖSTROEM.....	430
Septummeißel, NEIVERT-ANDERSON.....	442	SMITH, Lidsperrer.....	370	Stanze, CETELLI.....	430
Septummeißel, RUBIN.....	440	SMITH, Sagittalspreizer.....	463/5	Stanze, HAJEK-KÖFLER.....	429, 431
Septummeißel, SHEEHAN.....	441	SMITH, Spreizer.....	463/5	Stanze, KERRISON.....	428
Septummeißel, SILVER.....	442	SMITH US ARMY, Verbandschere.....	69/1	Stariöffel, DAVIEL.....	377
Septumrichtzange, ASCH.....	449	SMITH-BUIE, Analspreizer.....	561	Stariöffel, GRAEFE.....	377
Septumrichtzange, WALSHAM.....	449	SMITH-PETERSEN, Hohlmeißel.....	261	Stariöffel, KNAPP.....	378
Septumschere, KILLIAN.....	471	SMITH-PETERSEN, Hohlmeißelzange.....	238	Starmesser, DEUTSCHMANN.....	371
Septumzange, BRUENINGS.....	425	SMITH-PETERSEN, Osteotom.....	261	Starmesser, GRAEFE.....	371
Septumzange, GRAIG.....	426	SMITHWICK, Anlegezange.....	326	starrer Haltearm, LEYLA.....	368/1
Septumzange, LUC.....	426	SMITHWICK, Nervhaken.....	329	Starschlinge, ARLT.....	378
Septumzange, MIDDLETON-JANSEN.....	430	SNELLEN, Muskel pinzette.....	393	Starschlinge, SNELLEN.....	378
Septumzange, RUBIN.....	428	SNELLEN, Starschlinge.....	378	Starschlinge, WEBER.....	378
SERPENTINE-GRASPER, Faßzange, flexibel.....	593	SOMER, Uterus-Faßzange.....	585	Starschlinge, WILDER.....	378
SEUTIN, Verbandschere.....	69/2	Sonde VALLEIX.....	586	Stativ.....	188
SEXTON, Ohnmesser.....	408	Sonde, COLLIN.....	586	Staubinde, ESMARCH.....	296
Seziermesser, VIRCHOW.....	48	Sonde, FISH.....	199	STAUDE-MOORE, Hakenzange.....	582

Stechbecken.....	621	Supercutschere, FREEMAN	74	Titan-Arterienklemme, KELLY	106
STEINMANN, Endernagel	307, 308	Supercutschere, GORNEY	73	Titan-Pinzette, DeBAKEY, atrauma	99
STEINMANN, Knochenagel.....	307, 308	Supercutschere, IRIS	72	Titan-Buldgoklemme, atrauma	102
STEINMANN, Sehenhaltezange	292	Supercutschere, KAYE	73	TOBOLD, Watteträger	203
STELLBRINK, Hohlmeißelzange	234	Supercutschere, KILNER	72	TOBOLD, Zungendrücker	453
sterile Ersatzlinge	50	Supercutschere, LISTER	72	TOENNIS, Arterienklemme	117
sterile Skalpelle	43	Supercutschere, MAYO	71	TOENNIS, Dura-Dissektor	332
sterile Skalpelli-Klingen	42	Supercutschere, MAYO-STILLE	71	TOENNIS-ADSON, Schere	65
Sterilisierbehälter	616	Supercutschere, METZENBAUM	71	TOHOKU, Tuchklemme	132
Sterilisierkasten	616, 618	Supercutschere, REES	73	Tonometer, SCHIÖETZ	394/2
Sterilisierklammer, BUNT	227, 624	Supercutschere, REYNOLDS	72	Tonsillennadel, CLAUS	466
Sterilisierklammer, MAYO	227, 624	Supercutschere, STEVENS	72	Tonsillennadel, CLAUS-EICKEN	466
Sterilisiersiebschale	622	Supercutschere, WAGNER	72	Tonsillennadel, DUPUY-WEISS	466
Sterilisierzange	227	Supercutschere, BABY METZENBAUM	71	Tonsillennadel, NAGER	466
Sterilisierzange, CHEATLE	227	SWEET, Anlegezange	326	Tonsillendissektor, HURD	465
Sterilisierzange, ROGGE	227	SYSTRUNK, chirurgische Schere	66	Tonsillendissektor, LOPEZ-REINKE	465
Sterilisierzange, UNIVERSAL	227			Tonsillendissektor, YANKAUER	465
STERNBERG, Wangenhalter	453	T		Tonsillendradt	468
Sternnummeißel, LEBSCHE	267, 480	TABB, Messer	418	Tonsillenelevator, CARPENTER	465
Sternumschere, SCHUMACHER	481	Tablett	620	Tonsillenelevator, HENKE	465
Stethoskop, ANESTOPHON	23	Tablettenschale	621	Tonsillenfußpinzette, MARSCHIK	468
Stethoskop, DUPLEX	23	TAKAHASHI, Nasenzange	427	Tonsillenfäßzange, ABRAHAM	468
Stethoskop, PINARD	23	Tamponstopfer, LUNIATSCHEK	465	Tonsillenfasszange, COLVER	467
STEVENS, Irispinzette	383	Tamponzange, BOZEMANN	138	Tonsillennmesser, ABRAHAM	466
STEVENS, Linsenhaken	375	Tamponzange, BOZEMANN-DOUGLAS	138	Tonsillennmesser, BRUENINGS	466
STEVENS, Nadelhalter	214	Tangentialklemme, DeBAKEY	502	Tonsillennmesser, CANFIELD	466
STEVENS, Ophthalmologie-Schere	58	Tangentialklemme, DeBAKEY-SATINSKY	502	Tonsillennmesser, CARPENTER	465
STEVENS, Supercutschere	72	Tangentialklemme, SATINSKY	502	Tonsillennmesser, DOUGLAS	466
STEVENSON, Lidsperrer	371	TARNIER, Geburtszange	604	Tonsillennmesser, FISHER	466
STIEGLITZ, Splitterzange	92	TARNIER, Kranioclast	607	Tonsillennadel	470
STILLE, anatomische Pinzette	81	Taschenbesteck	225, 226	Tonsillenschere	59
STILLE, Arterienklemme	122	TAYLOR, chirurgische Pinzette	87	Tonsillenschere, BOETTCHEM	59
STILLE, chirurgische Pinzette	81/1	TAYLOR, Haken	196	Tonsillenschere, DEAN	59
STILLE, Flachmeißel	260	TAYLOR, Perkussionshammer	24	Tonsillenschere, GOOD	59
STILLE, Gipschere	229	TAYLOR, Spinalhaken	291	Tonsillenschere, PRINCE	59
STILLE, Handbohrapparat	298	TC chirurgische Schere fein, REYNOLDS	54	Tonsillenschürer, TYDING	469
STILLE, Hohlmeißel	260	TC chirurgische Schere, STANDARD	51	Tonsillenschürer, BRUENINGS	468
STILLE, Osteotom	260	TC Nasenraspel, FOMON	445	Tonsillenschürer, EVES	468
STILLE, Rippenschere	480	TC Pinzette, chirurgisch	81/1	Tonsillenspritze	470
STILLE-BARRAYA, Gefäßpinzette	88	TC Pinzette, CUSHING	83	Tonsillenzange, BALLENGER	467
STILLE-HORSLEY, Knochenplitterzange	242	TC Pinzette, GILLIES	86	Tonsillenzange, BLOHMKE	467
STILLE-LISTON, Knochenplitterzange	242	TC Pinzette, SEMKEN	86	Tonsillenzange, NEGUS	467
STILLE-LUER, Hohlmeißelzange	239	TC Pinzette, WAGENSTEEN	89	Tonsillenzange, SAWTELL	467
STILLE-RUSKIN, Hohlmeißelzange	239	TC Pinzette, anatomisch	81	Tonsillenzange, SCHMIDT	467
STILLE-SHERMAN, Handbohrapparat	298	TC Schere, FREEMAN	74	Tonsillenzange, TYDING	468
Stimmgabel, HARTMANN	403	TC Schere, PECK-JOSEPH	74	Tonsillenzange, WHITE	467
Stimmgabel, LUCAE	404	TC Schere, REES	73	Tonsillotom, SLUDER-BALLENGER	470
Stimmgabeln	403, 404	TC Schere, GORNEY	73	Tonsillotom, TYDING	469
Stimmgabeln, RYDEL-SEIFFERT	404	TC Schere, KAYE	73	TOOK, Hornhautmesser	373
Stirnhöhliendilatator, RITTER-HALLE	433	TEALE, Hakenzange	583	Toumiquet, RUMEL-BELMONT	528
Stirnlampe, CLAR	22	TEBBETTS, Wundhaken	197	TOWNLEY, Schieblehre	26
Stirnspiegel, ZIEGLER	21	Teleskop-Bohrdrahtstütze	299	TOWNSEND, Uterus-Biopsiezange	591
STOCKMANN, Penisklemme	553/1	TERSON, Kapselpinzette	391	TOYNBEE, Ohrspekula	399
STONE, Schließklemme	545	TESSIER, Haken	463/3	Trachealhaken, BOSE	477
STONE-WATT, Darmklemme	545	TESSIER, Mobilisierhaken	463/3	Trachealdilatator, TROUSSEAU-BABY	476
STONE-WATT, Klemmschloß	545	T-Handgriff, HUDSON	300	Trachealdilatator, LABORDE	476
Stöbel	258, 259	T-Handgriff, Schnellkupplung	300, 301	Trachealdilatator, TROUSSEAU	476
Stöbel, CASPAR	258	THOMAS, Uteruskürette	599	Trachealhaken, ITERSON	477
STRABISMUS, Schere	58	THOMAS-GAYLOR, Biopsiezange	588	Trachealhaken, JACKSON	476
Strabismuspinzette, BONACCOLTO	385	THOMS-ALLIS, Darmfaßzange	538	Trachealhaken, NEWS	477
Strabismuspinzette, DASTOOR	386	THOMSON-WALKER, Blasenwundspreizer	552	Trachealhaken, CHEVALIER-JACKSON	479
Strabismuspinzette, JAMESON	385	Thoraxsperrer, MERCEDES	489	Trachealkanüle, LUER	479
Strabismuspinzette, McCULLOUGH	385	THOREK, Gallenblasenschere	65/2	Trachealkanüle, WAGENER-MOSHER	477
STRANDELL-STILLE, Wundhaken	157	THUDICHUM, Nasenspekula	421	Trachealwundspreizer, BOSE	476
STRASSBURGER, Pinzette	89	TIECK-HALLE, Nasenspekula	423	Tracheotomie-Bestek	478
STRATTE, Nadelhalter	212	Tiefen-Messinstrument	594	Trachompinzette, KNAPP-LUER	393
STRAUSS, Penisklemme	553/1	Tiefensäge	231/2	Tränenkanaldilatator, ZIEGLER	381
STRUEMPEL, Fremdkörperzangchen	412	TILLEY, Ohrzangchen	411	Tränenkanaldilatator, CASTROVIEJO	381
STRULLY, neuro-chirurgische Schere	65	TISCHLER-DOWN, Uterus-Biopsiezange	591	Tränenkanaldilatator, WILDER	381
STRUYCKEN, Nasenzange	427	TISCHLER-KEVORKIAN, Uterus-Biopsiezange	592	Tränenkanalsonde, BOWMAN	381
SUBRAMANIAN, Kinder-Gefäßklemme	521	TISCHLER-MORGAN, Uterus-Biopsiezange	590, 591	Tränensackdissektor, LANG	378
SUBRAMANIAN-MINIATURE, Kinder-Gefäßklemme	521	TISCHLER-UP, Uterus-Biopsiezange	591	Tränensackhächen, KNAPP	375
Supercutschere	71	Titan-Arterienklemme, CRILE	107	Tränensackhächen, ROLLET	375

TRAVERS, Wundspreizer.....	172	Unterbindungsnadel, KRONECKER.....	219	Verbandschere, SMITH US ARMY.....	69/1
TRELAT, Scheidenspekula.....	571	Unterbindungsnadel, NELSON.....	219	Verbandschere, UNIVERSAL.....	70
Trepbine, KEYES.....	608	Unterkieferhaken, HARGIS.....	463, 463/6	Verbandstofftrommel, SCHIMMELBUSCH.....	622
TROELTSCH, Nasenpinzette.....	424	Urethrotom, OTIS.....	553	Verbindungskabel.....	633
TROELTSCH, Ohrpinzette.....	410, 424	US-ARMY, Wundhaken.....	141	VERBRUGGE, Knochenhaltezeuge.....	245
TROEMNER, Perkussionshammer.....	24	USA, anatomische Pinzette.....	81	VERBRUGGE-MÜLLER, Knochenhebel.....	287
Trokar, SINOSKOPIE.....	205	USA Modell, Verbindungskabel.....	633	VERESS, Insufflationskanüle.....	206
Trokar, NELSON.....	205	Uterusdilator, GOODELL.....	581	Verlängerungsrohr, BRUENINGS.....	472
Trokar, OCHSNER.....	205	Uterusdilator, HANK.....	580	Verlängerungsstück.....	299
Trokar, UNIVERSAL.....	204	Uterusdilator, PRATT.....	580	VIENNA, Führungshohlsonde.....	221
Trokar, STANDARD (NELSON).....	204	Uterusdilator, SIMS.....	581	VIRCHOEW, Seziermesser.....	48
TROUSSEAU-BABY, Trachealdilator.....	476	Uterusdilator, WYLIE.....	581	VIRTUS (RALK), Splitterzange.....	92
TROUSSEAU, Trachealdilator.....	476	Uteruspolyenzange, DOYEN.....	585	VOLKMANN, Doppellöffel.....	257
TROUTMAN, Irispinzette.....	384	Uteruspolyenzange, KELLY.....	585	VOLKMANN, Knochenhaken.....	156
TROUTMAN, Muskelpinzette.....	389	Uteruspolyenzange, NOTO.....	585	VOLKMANN, scharfer Löffel.....	251, 257
TROUTMAN-CHRIS, Klängenbrecher.....	45	Uterus-Biopsiezaange, KEVORKIAN-PACIFIC.....	592	VOLKMANN, Wundhaken.....	153, 154, 156
TUBBS, Aortadilator.....	528	Uterus-Biopsiezange, SCHUMACHER.....	589	VOLTOLINI, Nasenspekula.....	421
Tubenkatheter f. SCHULTZE.....	596	Uterus-Biopsiezange, TISCHLER-KEVORKIAN.....	592	Vorbohrer, KUENTSCHER.....	321
Tuchklemme.....	133	Uterus-Biopsiezange, TOWNSEND.....	591	VU-MORE, Scheidenspekula.....	569
Tuchklemme, BALL AND SOCKET.....	133	Uterus-Biopsiezange, ALEXANDER.....	589		
Tuchklemme, BACKHAUS.....	132	Uterus-Biopsiezange, BABY-TISCHLER.....	592	W	
Tuchklemme, BACKHAUS-CLIP.....	132	Uterus-Biopsiezange, BURKE.....	590	WACHENFELDT, Wundklammerpinzette.....	224
Tuchklemme, BERNHARD.....	133	Uterus-Biopsiezange, BURKE-BABY.....	590	WADSWORTH-TODD, Cauter.....	378
Tuchklemme, DOYEN.....	133	Uterus-Biopsiezange, EPPENDORFER.....	590	WAGENER-MOSHER, Trachealkanüle.....	477
Tuchklemme, JONES.....	132	Uterus-Biopsiezange, KEVORKIAN.....	589, 591	WAGNER, Hähchen.....	409
Tuchklemme, JONES-CLIP.....	132	Uterus-Biopsiezange, MAXI GRASPER.....	593	WAGENSTEEN, Gefäßpinzette.....	89
Tuchklemme, LANE.....	133	Uterus-Biopsiezange, MINI-TOWNSEND-DOWN.....	591	WAGNER, Laminektomiezange.....	343
Tuchklemme, LORNA.....	133	Uterus-Biopsiezange, MINI-TOWNSEND-UP.....	591	WAGNER, SCHERE.....	67
Tuchklemme, MOYNIHAN.....	133	Uterus-Biopsiezange, TISCHLER-DOWN.....	591	WAGNER, Supercutschere.....	72
Tuchklemme, PEERS.....	132	Uterus-Biopsiezange, TISCHLER-MORGEN.....	590, 591	WALDMANN, Episotomie-Schere.....	64
Tuchklemme, ROEDER.....	132	Uterus-Biopsiezange, TISCHLER-UP.....	591	WALLICH, Abortuslöffel.....	607
Tuchklemme, SCHAEDEL.....	132	Uterus-Biopsiezange, WITTNER.....	589	WALSHAM, Septumrichtzange.....	449
Tuchklemme, TOHOKU.....	132	Uterus-Depressor, BRAUN.....	586	WALTON, Fremdkörperhohlmeißel.....	374
TUFFIER, Gewebefäßzange.....	110	Uterus-Depressor, SIMS.....	586	WALTON, Fingerringzange.....	297
TUFFIER, Rippensperrer.....	487	Uterus-Dilatator, HEGAR.....	578, 579	WALTON, Komodonquetscher.....	608
TUFFIER, Wundhaken.....	147	Uterus-Faßzange, COLLIN.....	585	Wangenhalter.....	453, 451
Tumorfasszange, LANDOLT.....	341	Uterus-Faßzange, DARTIGUES.....	585	Wangenhalter, CAWOOD-MINNESOTA.....	451
Tumorpinzette, YASARGIL.....	97	Uterus-Faßzange, SOMER.....	585	Wangenhalter, STERNBERG.....	453
Tupferzange, BRYANT.....	137	Uterus-Kürette, BLAKE.....	595	WANGENSTEEN, Nadelhalter.....	210
Tupferzange, CHERON.....	137	Uterus-Kürette, BUMM.....	597, 598	WARTENBERG, Nervdrähtchen.....	25
Tupferzange, COLLIN.....	137	Uterus-Kürette, RECAMIER.....	597, 598	WATSON, Dermatome.....	50
Tupferzange, FOERSTER.....	136	Uterus-Kürette, SIMS.....	597, 598	WATSON-CHEYNE, Elevator.....	283
Tupferzange, LISTER (SINUS).....	137	Uterus-Kürette, THOMAS.....	599	WATSON-CHEYNE, Sonde.....	199
Tupferzange, PELKMANN.....	137	Uterus-Löffel, SIMON.....	594	WATSON-WILLIAMS, Nasenzange.....	428
Tupferzange, RAMPLEY.....	136	Uterus-Löffel, GOURDET.....	599	Watteträger, FARRELL.....	203
TURNBULL, Nagelzange.....	609	Uterus-Löffel, SCHRÖDER.....	595	Watteträger, JOBSON-HORNE.....	203
TURREL, Mastdarmbiopsiezange.....	567	Uterus-Sonde, VALLEIX.....	586	Watteträger, REDA.....	203
TYDING, Tonsillenschnürer.....	469	Uterus-Sonde, COLLIN.....	586	Watteträger, TOBOLD.....	203
TYDING, Tonsillenzange.....	468	Uterus-Sonde, MARTIN.....	586	Watteträger, UCKERMANN.....	203
TYDING, Tonsillotom.....	469	Uterus-Sonde, SIMS.....	586	WAUGH, chirurgische Pinzette.....	83
U		Uterus-Zange, GREEN-ARMYTAGE.....	605	WEBER, Aortaklemme.....	501
USA MOD., Nabelschnur-Schere.....	64			WEBER, Starschlinge.....	378
UCKERMANN, Watteträger.....	203	V		WEBSTER, Nadelhalter.....	208
Uhrmacher Pinzette.....	90	VALLEIX, Uterus-Sonde.....	586	WECKER, Augenschere.....	75
ULRICH, Knochenhaltezeuge.....	248	Valve f. Bauchdeckenhalter, BALFOUR.....	183	WECKER, Iris spatel.....	378
ULRICH, Kornzange.....	135	Valve f. Bauchdeckenhalter, HORGAN.....	183	WEEK, Lidsperrer.....	370
ULTA-LIGHT, Pinzette, atrauma.....	95	Valven f. Scheidenspekula, O'SULLIVAN-O'CONNOR.....	576	WEIL-BLAKESLEY, Nasenzange.....	426
UNI I, Diagnostik-Besteck.....	13	VAN BUREN, Dilatationsbougie.....	554	WEITLANER, Wundspreizer.....	169
UNI III, Diagnostik-Besteck.....	15	VAN BUREN, Knochenhaltezeuge.....	249	WEITLANER-WULLSTEIN, Wundspreizer.....	169
UNIVERSAL, Drahtschere.....	67	VAN DOREN, Biopsiezange.....	588	WELLER, Präparierschere.....	53/2
UNIVERSAL, Endoskophalterung.....	188	VANNAS, Augenschere.....	79	WELLS, Enukektionslöffel.....	378
UNIVERSAL, Pulverbläser.....	405	VARADY, Varizeninstrument.....	202	WERTHEIM, gynäkologische Schere.....	62
UNIVERSAL, Sterilisierzange.....	227	Varizeninstrument, VARADY.....	202	WERTHEIM, Hysterektomieschere.....	63
UNIVERSAL, Trokar.....	204	Vasektomieklammer.....	553/1	WERTHEIM, Hysterektomieklammer.....	124, 128
UNIVERSAL, Verbandschere.....	70	Verbandschere.....	70	WERTHEIM-CULLEN, Nierenstiellammer.....	125
Universalsgriff, HUBER.....	472	Verbandschere, BERGMANN.....	69/1	WEST, Hohlmeißel.....	442/1
Universelle Wundhakenhalterung für Armsystem.....	188	Verbandschere, BRUNS.....	70	WEST, Nasenmeißel.....	442/1
UNNA, Komodonquetscher.....	608	Verbandschere, ESMARCH.....	69/2	WESTCOTT, Augenschere.....	75
Unterbindungsnadel.....	218	Verbandschere, KNOWLES.....	70	WESTMACOTT, Nasentamponzange.....	424
Unterbindungsnadel, SCHMIEDEN-DICK.....	219	Verbandschere, LISTER.....	69/1	WESTON, Rektalschnürer.....	566
Unterbindungsnadel, COOPER.....	219	Verbandschere, LORENZ.....	70	WHEELER, Disziplinsmesser.....	373
Unterbindungsnadel, DESCHAMPS.....	218	Verbandschere, REDA EXCENTER.....	69/2	WHEELER, Zykliodials spatel.....	379
		Verbandschere, SEUTIN.....	69/2	WHITE, Tonsillenzange.....	467

WIEDER, Zungendrucker	452	Wundhaken, ISRAEL	162	WYLIE, Uterus-Dilatator	581
WIENER, Antrumraspel	443	Wundhaken, JANSEN	168	Y	
WIENER, Irishähchen	375	Wundhaken, KELLY	164	YANCOSKIE, Wundhaken	198
WIGMORE, Gipsmesser	229	Wundhaken, KELLY-GRIP	142	YANKAUER, Saugrohr	27
WIKSTROEM, Arterienklemme	117	Wundhaken, KLAPP	150	YANKAUER, Tonsillen-Dissektor	465
WILDE, Polypenschürer	411, 433/2	Wundhaken, KOCHER-LANGENBECK	159	YASARGIL, Galeahaken	330
WILDE (TROELTSCH), Ohrpinzette	410	Wundhaken, KOERTE	162	YASARGIL, Gefäßclip	345 - 356
WILDER, Starschlinge	378	Wundhaken, LAHEY	157	YASARGIL, SAUGROHR	337/1
WILDER, Tränenkanal-Dilatator	381	Wundhaken, LANGENBECK	158, 159	YASARGIL, Tumorphinzette	97
WILLET-MARTEL, Faßzange	110	Wundhaken, LANGENBECK-GREEN	153	YEOMAN, Mastdarm-Biopsiezange	566, 567
WILLIAMS, Darmfaßzange	539	Wundhaken, LITTLE	157	YOUNG-BOOMERANG, Nadel	220
WILLIAMS, Lidsperrerr	370	Wundhaken, LOVE	465	YOUNG, Prostatahaken	550
WILLIAMS, Schraubenzieher	323	Wundhaken, MATHIEU	141	YOUNG, Zungenzange	453
WILLIGER, Hammer	271	Wundhaken, MIDDELDORPF	160	Z	
WILLIGER, Raspator	276	Wundhaken, MIKULICZ	163	Zahnfleischschere, LA GRANGE	69
WILLIGER, scharfer Löffel	255, 257	Wundhaken, NAGER	465	Zahnfleischschere, Supercut, LA GRANGE	72
Winkelmesser, MOELTGEN	25	Wundhaken, OBWEGESER	460, 461	Zahnfleischschere, GOLDMAN-FOX	67
WINTER, Abortuszange	606	Wundhaken, OLLIER	162	Zahnfleischschere, LOCKLIN	69
Wirbelkörperspreizer, CLOWARD	339	Wundhaken, PARKER	139	Zahnfleischschere, QUINBY	67
Wirbelkörperspreizer, INGE	339	Wundhaken, RAGNELL	140	Zahnfleischschere, LONDON-COLLEGE	93
WITTNER, Uterus-Biopsiezange	589	Wundhaken, RAMUS	461	Zahnpinzette, MERIAM	93
WOLFF, Gipsabreißzange	233	Wundhaken, RICHARDSON	142	Zange, JURASZ	471
WOODSON, Dura-Dissektor	333	Wundhaken, RICHARDSON-GRIP	142	ZAUFAL, Ohrhebel	409
WORST, Sonde	381	Wundhaken, RICHARDSON-EASTMAN	142	ZAUFAL-JANSEN, Hohlmeißelzange	238
WRIGLEY, Geburtszange	602	Wundhaken, ROSE	140	ZAUFAL-JANSEN, Ohrhebel	409
WULLSTEIN, Messer	418	Wundhaken, ROUX	139	ZEIGLER, Lidsperrerr	371
WULLSTEIN, Mikro-Löffelzängchen	416	Wundhaken, ROUX-BABY	140	ZENKER, Arterienklemme	118
WULLSTEIN, Mikro-Ohrzängchen	416	Wundhaken, ROUX-Mini	140	ZENKER, Wundhaken	161
WULLSTEIN, Sauggriff	338	Wundhaken, SAUERBRUCH	164, 166	zerlegbare Stanze, FERRIS-SMITH-KERRISON	344/2
WULLSTEIN, Wundspreizer	171	Wundhaken, SENN-GREEN	153	ZIEGLER, Disziionsmesser	373
Wundhaken	463/3	Wundhaken, SENN-MILLER	143	ZIEGLER, Irismesser	372
Wundhaken, ANDERSON	198	Wundhaken, SIMON	164	ZIEGLER, Stirnspiegel	21
Wundhaken, AUFRANC-COBRA	289	Wundhaken, SPINA-NASALIS	461	ZIEGLER, Tränenkanal-Dilatator	381
Wundhaken, BREAST	198	Wundhaken, STRANDELL-STILLE	157	ZIELKE, Hohlmeißel	264
Wundhaken, CORONAL-BLOW-LIFT	198	Wundhaken, VOLKMANN	153, 154, 156	Zirkular-Stanze	432
Wundhaken, FERRIERA	197	Wundhaken, ZENKER	161	ZÖLLNER, Saugrohr	337/1
Wundhaken, FINSEN	168	Wundhaken, KOCHER	155, 159, 160, 163	Zubehör f. Autopsiesäge	231/2, 231/3
Wundhaken, FREEMAN	198	Wundhaken, US-ARMY/PARKER-LANGENBECK	141	Zughaken, KIRSCHNER	313
Wundhaken, KÖNIG	153	Wundhakenhalterung	188	Zughebel, BARTON	603
Wundhaken, MEYERDING	177	Wundklammern, MICHEL	224	Zughebel, BILL	604
Wundhaken, MORRIS	164	Wundklammerpinzette, HEGENBARTH	224	Zughebel, LUIKART-BILL	604
Wundhaken, MURPHY	156	Wundklammerpinzette, MICHEL	224	Zugseil f. NABATOFF	201
Wundhaken, St. MARKS	165	Wundklammerpinzette, WACHENFELDT	224	Zungendrucker, ANDREW	452
Wundhaken, TEBBETTS	197	Wundklammerzange, CHILDE	224	Zungendrucker, DAVIS-BOYLE	455
Wundhaken, TUFFIER	147	Wundklammerzange, COLLIN	224	Zungendrucker, DINGMANN	456
Wundhaken, YANCOSKIE	198	Wundklammerzange, COLLIN	224	Zungendrucker, HARTMANN	452
Wundhaken, ALM	168	Wundklammerzange, MICHEL	224	Zungendrucker, KILNER-DOUGHTY	456
Wundhaken, BRUNNER	167	Wundklammerzange, RICHTER-HEATH	224	Zungendrucker, TOBOLD	453
Wundhaken, COLLIN	139	Wundlöffel, ARRUGA	378	Zungendrucker, WIEDER	452
Wundhaken, COLLIN-HARTMANN	141	Wundnahtbesteck	225, 226	Zungenspatel	451
Wundhaken, COOLEY	148	Wundsperrerr, CLOWARD	178	Zungenspatel, BRUENINGS	451
Wundhaken, CORYLLOS	166	Wundspreizer, ADSON	172 - 174	Zungenspatel, BUCHWALD	451
Wundhaken, CRILE	140	Wundspreizer, CASPAR	179	Zungenspatel, DOUGHTY	458
Wundhaken, CUSHING	151, 152	Wundspreizer, MAYO-ADAMS	171	Zungenspatel, FRENZEL	451
Wundhaken, DAVIDSON (Scapula)	166	Wundspreizer, NORDFOLK/NORWICH	172	Zungenspatel, KROENIG	451
Wundhaken, DEAVER	145, 146	Wundspreizer, PERKINS	168	Zungenspatel, MAYO	451
Wundhaken, DEAVER-GRIP	146	Wundspreizer, PLESTER	171	Zungenspatel, MORITZ-SCHMIDT	452
Wundhaken, DESMARRRES	151	Wundspreizer, SCALP-CONTOUR	169	Zungenspatel, RING	455
Wundhaken, DOYEN	163	Wundspreizer, TRAVERS	172	Zungenspatel, RUSSEL-DAVIS	458
Wundhaken, DOYEN-STILLE	167	Wundspreizer, WEITLANER-WULLSTEIN	169	Zungenzange, COLLIN	453
Wundhaken, FARABEUF	139	Wundspreizer, WULLSTEIN	171	Zungenzange, YOUNG	453
Wundhaken, FRITSCH	163	Wundspreizer, ADSON-BABY	173	Zwischenknochen-Messer	44
Wundhaken, GIL-VERNET	152	Wundspreizer, ANDERSON-ADSON	172	Zwischenstück f. SCHULTZE Salpingograph	596
Wundhaken, GOELET	141	Wundspreizer, ANDERSON-ADSON	172	Zyklodialysespatel, BARGERTER	379
Wundhaken, GREEN	160	Wundspreizer, BECKMANN	176	Zyklodialysespatel, ELSCHNIG	379
Wundhaken, HARGIS	463	Wundspreizer, BECKMANN-ADSON	175	Zyklodialysespatel, HIRSCHMANN	379
Wundhaken, HARRINGTON	147	Wundspreizer, BECKMANN-EATON	176	Zyklodialysespatel, WHEELER	379
Wundhaken, HARRINGTON-PEMBERTON	147	Wundspreizer, BOSE	476	Zyklodialysespatel, CASTROVIEJO	379
Wundhaken, HEANEY	164	Wundspreizer, DARLING	178		
Wundhaken, HIBBS	164	Wundspreizer, HENLEY	170		
Wundhaken, HOESEL	167	Wundspreizer, HENLEY	170		
Wundhaken, HOFER	465	Wundspreizer, MARTIN	175/1		
Wundhaken, HOLZHEIMER	168	Wundspreizer, MEYERDING	180		
		Wundspreizer, MOLLISON	171		
		Wundspreizer, PLESTER	171		
		Wundspreizer, WEITLANER	169		

ABDOMINAL- A. BOWEL SPATULA KÜMMEL.....	143/2, 144	ANAL RETRACTOR SMITH-BUIE.....	561	ATRAUMATIC TISSUE FORCEPS DEBAKEY.....	99
ABDOMINAL RETRACTOR KIRSCHNER.....	187, 187/1	ANAST.KL. DE MARTEL-WOLFSON.....	546	AUFRANC RETRACTOR.....	289
ABDOMINAL RETRACTORS BABY GOSSET.....	181	ANASTOMOSIS CLAMP BECK.....	516	AUFREIBER KUENTSCHER.....	321
ABDOMINAL RETRACTORS BALFOUR.....	182	ANASTOMOSIS CLAMP BECK.....	520	AUFRICHT NOSE HOOK.....	447
ABDOMINAL RETRACTORS BALFOUR BABY.....	182	ANASTOMOSIS CLAMP COOLEY.....	519, 520	AUFRICHT NOSE RASP.....	443
ABDOMINAL RETRACTORS BALFOUR-US.....	184	ANASTOMOSIS CLAMP COOLEY-DERRA.....	519	AURIKELCLAMP HARKEN.....	503
ABDOMINAL RETRACTORS CHARNELY.....	289	ANASTOMOSIS CLAMP DEBAKEY.....	505	AUTOPSY KNIVES.....	48
ABDOMINAL RETRACTORS COLLIN.....	190	ANASTOMOSIS CLAMP LAMBERT-KAY.....	505	AUTOPSY SAW.....	231/1
ABDOMINAL RETRACTORS COLLIN-LOKTTITE.....	191	ANATOMIC TISSUE FORCEPS BROPHY.....	84	AUVAUD VAGINAL SPECULA.....	576
ABDOMINAL RETRACTORS DENIS-BROWNE.....	186	ANATOMIC TISSUE FORCEPS.....	81	AWL.....	304
ABDOMINAL RETRACTORS DOYEN.....	189/1	ANATOMIC TISSUE FORCEPS ADSON.....	81/2	AWL HARGIS.....	463
ABDOMINAL RETRACTORS FRAZIER.....	181	ANATOMIC TISSUE FORCEPS ADSON MICRO.....	81/2	AWL PERTHES.....	304
ABDOMINAL RETRACTORS GELPI.....	189/1, 189/2	ANATOMIC TISSUE FORCEPS BONNEY.....	88	AXENFELD CHALAZIO CURETTE.....	377
ABDOMINAL RETRACTORS GOSSET.....	181	ANATOMIC TISSUE FORCEPS CUSHING.....	83	AYER CHALAZIO TISSUE FORCEPS.....	393
ABDOMINAL RETRACTORS KIRSCHNER.....	185, 187	ANATOMIC TISSUE FORCEPS CUSHING-TAYLOR.....	87		
ABDOMINAL RETRACTORS RICARD.....	191	ANATOMIC TISSUE FORCEPS DUEHRSSEN.....	84	B	
ABDOMINAL RETRACTORS RIGBY.....	189/2	ANATOMIC TISSUE FORCEPS GERALD.....	86	BABCOCK BOWEL GRASPING FORCEPS.....	539
ABDOMINAL RETRACTORS ROCHARD.....	186	ANATOMIC TISSUE FORCEPS MCINDOE.....	85	BABINSKI PERCUSSION HAMMER.....	24
ABDOMINAL SPATULA KADER.....	143/1	ANATOMIC TISSUE FORCEPS POTTS-SMITH.....	81	BABY BURKE BIOPSY FORCEPS.....	590
ABDOMINAL SPATULA LERICHE.....	143/2	ANATOMIC TISSUE FORCEPS SEMKEN.....	86	BABY GOSSET ABDOMINALRETRACTORS.....	181
ABLI OPHTHALMOLOGIC SCISSORS.....	58	ANATOMIC TISSUE FORCEPS TAYLOR.....	87	BABY METZENBAUM SUPERCUT SCISSORS.....	71
ABRAHAM TONSIL FORCEP.....	468	ANATOMIC TISSUE FORCEPS TC.....	81	BABY TISCHLER RONGEUR.....	592
ABRAHAM TONSIL KNIVES.....	466	ANATOMIC TISSUE FORCEPS TYPE USA.....	81	BABY WEBSTER NEEDLE HOLDER.....	208
ACCESSORIES FOR AUTOPSY SAW.....	231/3	ANATOMIC TISSUE FORCEPSSTILLE.....	81	BABY YANKAUER SUCTION TUBE.....	27
ADENOID CURETTE BARNHILL.....	450	ANDERSON ADSON RETRACTORS.....	172	BABY-KOCHER BOWEL CLAMP.....	540
ADENOID CURETTE BECKMANN.....	450	ANDERSON RETRACTOR.....	198	BABY-OLSEN-HEGAR NEEDLE HOLDER.....	212
ADENOID CURETTEST.CLAIR-THOMSON.....	450	ANDREW TONGUE DEPRESSOR.....	452	BABYPHON SPHYGMOMANOMETER.....	10
ADENOTOM LA FORCE.....	450	ANDREW-PYNCHON SUCTION TUBE.....	28	BACK HOLDER ABDOMINAL RETRACTOR SYSTEM.....	192, 193, 194, 195
ADLERKREUTZ VASCULARTISSUE FORCEPS.....	84	ANESTOPHON.....	23	BACKHAUS TOWEL CLAMP.....	132
ADSON RETRACTORS.....	173	ANEURYSM CLAMP DEBAKEY-BAHNSON.....	506	BACKHAUS-CLIP.....	132
ADSON ANATOMIC TISSUE FORCEPS.....	81/2	ANEURYSM CLIPS APPLIER FORCEPS.....	357,358, 359, 360	BAILEY RIB SPREADER.....	489
ADSON ANATOMIC TISSUE FORCEPS.....	81/2	ANEURYSM VASCULAR CLIP YASARGIL.....	349, 350, 351, 352, 353, 354, 355, 356	BAILEY-BABY RIB SPREADER.....	489
ADSON BABY HEMOSTATIC CLAMP.....	113	ANOSCOPE HIRSCHMANN.....	562	BAILEY-GIBBON RIB SPREADER.....	489
ADSON BONE RONGEUR.....	236	ANOSCOPE IVES-FANSLER.....	562	BAINBRIDGE HEMOSTATIC CLAMP.....	120
ADSON DURAHOOK.....	328	ANTRUM CURETTE COAKLEY.....	449	BAINBRIDGE VASCULAR CLAMP.....	495
ADSON HEMOSTATIC CLAMP.....	112	ANTRUM RASP GALLAHER.....	446	BAKES GALL DUCT DILATOR.....	532
ADSON HOLDING CLAMP.....	298	ANTRUM RASP LEWIS.....	443	BALFOUR ABDOMINALRETRACTORS.....	182
ADSON HYPOPHYSE-TISSUE FORCEPS.....	334	ANTRUM-CURETTE.....	435	BALFOUR BABY ABDOMINALRETRACTORS.....	182
ADSON MICRO ANATOMIC TISSUE FORCEPS.....	81/2	ANVIL NAILSPALTFORCEPS.....	613	BALFOUR HOOK.....	193
ADSON MICRO SURGICAL TISSUE FORCEPS.....	81/2	AORTIC DILATOR COOLEY.....	528	BALFOUR-US ABDOMINALRETRACTORS.....	184
ADSON NEEDLE HOLDER.....	211	AORTIC-DILATOR TUBBS.....	528	BALL AND SOCKET TOWEL CLAMP.....	133
ADSON RASPATORIES.....	282	APPENDIXBOWEL CLAMP ALLEN.....	544	BALL ELECTRODE MONOPOLAR.....	628, 629
ADSON RETRACTORS.....	172,173,174	APPENDIXBOWEL CLAMP KLEINSCHMIDT.....	544	BALLENGER SCHWINGKNIVES.....	436
ADSON SUCTION TUBE.....	337	APPLIER FORCEPS ANEURISIMEN CLIPS.....	357,358, 359, 360	BALLENGER SEPTUM ELEVATOR.....	439
ADSON SURGICAL TISSUE FORCEPS.....	81/2	APPLIER FORCEPS BIEMER.....	361, 366	BALLENGER TONSIL FORCEPS.....	467
ADSON-BROWN SURGICAL TISSUE FORCEPS.....	82	APPLIER FORCEPS MEHDORN.....	362	BANDAGE CUFF.....	295
ADSON-DEBAKEY ATRAUMATIC FORCEPS.....	81/2	APPLIERFORCEPS JOHNS-HOPKINS.....	104	BANDAGE DRUMSSCHIMMELBUSCH.....	622
AHLE OBWEGESER.....	463	APPLIERFORCEPS MC KENZIE.....	326	BANDAGE SCISSORS.....	70
AIR BLOWER.....	405	APPLIERFORCEPS SMITHWICK.....	326	BANDAGE SCISSORS BERGMANN.....	69/1
AIR BLOWER POLITZER.....	406	APPLIERFORCEPS SWEET.....	326	BANDAGE SCISSORS BRUNS.....	70
AIR INJECTION EYE CANNULA.....	394	APPLING FORCEPS RANEY.....	327	BANDAGE SCISSORS ESMARCH.....	69/2
AIR PUMP.....	295	APPROXIMATOR BIEMER.....	366	BANDAGE SCISSORS KNOWLES.....	70
ALAN-PARKS RECTAL-SPECULA.....	561	APPROXIMATOR BIEMER-MÜLLER.....	363	BANDAGE SCISSORS LISTER.....	69/1
ALDERDYCE ELEVATOR.....	282	APPROXIMATOR MÜLLER.....	364	BANDAGE SCISSORS LORENZ.....	70
ALEXANDER BIOPSY FORCEPS.....	589	ARCHER SPLINTERFORCEPS.....	92	BANDAGE SCISSORS REDA EXCENTER.....	69/2
ALEXANDER CHISELS.....	259	ARLT CATARACT LOOP.....	378	BANDAGE SCISSORS SEUTIN.....	69/2
ALEXANDER RASPATORIES.....	276	ARMSYSTEM.....	188	BANDAGE SCISSORS SMITH US ARMY.....	69/1
ALLEN APPENDIX BOWEL CLAMP.....	544	ARRUGA CAPSULAR FORCEPS.....	391	BANDAGE SCISSORS UNIVERSAL.....	70
ALLIS BOWEL GRASPING FORCEPS.....	537	ARRUGA EXTRACTION HOOK.....	375	BANE-HARTMANN BONE RONGEUR.....	237
ALLIS-ADAIR BOWEL GRASPING FORCEPS.....	537	ARRUGA EYE SPECULA.....	370	BANGERTER CYCLODIALYSIS SPATULA.....	379
ALLIS-BABY BOWEL GRASPING FORCEPS.....	537	ARRUGA NEEDLE HOLDER.....	214	BARACANI INTERCHANGEABLE TIPS.....	472
ALLISON LUNG SPATULA.....	489	ARRUGA WOUND CURETTE.....	378	BARANY AIR BLOWER.....	405
ALM RETRACTOR.....	168	ASCH SEPTUM STRAIGHTENING FORCEPS.....	449	BARBARA HOOK.....	419
ALVIS FOREIGN-BODY CURETTE.....	374	ATRAUMA BULLDOG CLAMP.....	100	BARBARA NEEDLE.....	419
AMNIOSCOPE.....	601	ATRAUMA BULLDOG CLAMP.....	100, 102	BARKAN GONIOTOMY KNIVES.....	373
AMNIOTOME BEACHAM.....	586	ATRAUMA CLAMP DEBAKEY.....	100	BARNHILL ADENOID CURETTE.....	450
AMPUTATION KNIVES CATLIN.....	44	ATRAUMA CLAMP DEBAKEY.....	103	BARON SUCTION TUBE.....	336
AMPUTATION KNIVES LANGENBECK.....	44	ATRAUMA CLAMP GLOVER.....	100	BARR RECTAL SPECULA.....	559
AMPUTATION KNIVES LISTON.....	44	ATRAUMA CLAMP GLOVER.....	103	BARRAQUER CILIA FORCEPS.....	395
AMPUTATION KNIVES REDA.....	44	ATRAUMA-BULLDOG CLAMP GLOVER.....	103	BARRAQUER EYE SPECULA.....	370
AMPUTATION SAW BIER.....	296	ATRAUMA-NEONATAL CLAMP.....	523	BARRAQUER EYESCISSORS.....	75
AMPUTATION SAW CHARRIERE.....	296	ATRAUMATIC FORCEPS ADSON-DEBAKEY.....	81/2	BARRAQUER FIXATION FORCEPS.....	390
AMPUTATION SAW SATTERLEE.....	296				

BARRAQUER KERATOPLAST-KNIVES.....	373	BIPOLAR-CABLE.....	633	BONE HOLDING FORCEPS.....	249
BARRAQUER NEEDLE HOLDER.....	217	BIPOLAR-TISSUE FORCEPS.....	630, 631	BONE HOLDING FORCEPS BIRCHER-GANSKE.....	246
BARRAQUER NEEDLE HOLDER.....	216, 217	BIPOLAR-TISSUE FORCEPS BAJONETT.....	632	BONE HOLDING FORCEPS DINGMANN.....	246
BARRAQUER-KATZIN IRIS TISSUE FORCEPS.....	384	BIRCHER-GANSKE BONE HOLDING FORCEPS.....	246	BONE HOLDING FORCEPS FARABEUF.....	243
BARRET HOOK FORCEPS.....	582	BIRKETT HEMOSTATIC CLAMP.....	116	BONE HOLDING FORCEPS FARABEUF-L.....	243
BARTON OBSTETRICAL FORCEPS.....	603	BISHOP-HARMAN IRIS TISSUE FORCEPS.....	386	BONE HOLDING FORCEPS FERGUSSON.....	243
BATTERY HANDLE F. COLD LIGHT.....	33	BISHOP-HARMAN IRRIGATION CANNULA.....	394/1	BONE HOLDING FORCEPS KERN.....	244
BATTERY HANDLE F. WARM LIGHT.....	32	BLADDER RETRACTORS LEGUE.....	553	BONE HOLDING FORCEPS LAMBOTTE.....	244
BAUMGARTNER NEEDLE HOLDER.....	208	BLADDER RETRACTORS MILLIN.....	552	BONE HOLDING FORCEPS LANE.....	244
BEACHAM AMNIOTOME.....	586	BLADDER RETRACTORS THOMSON-WALKER.....	552	BONE HOLDING FORCEPS LANGENBECK.....	243
BECHERT NUCLEUS ROTATOR.....	379	BLADDER RETRACTORSJUDD-MASSON.....	552	BONE HOLDING FORCEPS LEWIN.....	246
BECK ANASTOMOSIS KL.....	520	BLADDER SPATULA KOCHER.....	552	BONE HOLDING FORCEPS REDA.....	246, 247
BECK VASCULAR CLAMP.....	516	BLADDER SPATULA LEGUEU.....	552	BONE HOLDING FORCEPS REILL.....	248
BECKER CYSTOTOM.....	375	BLADDER SPREADER MILLIN.....	553	BONE HOLDING FORCEPS SEMB.....	243
BECKMANN ADENOID CURETTE.....	450	BLADE SCALPEL.....	42	BONE HOLDING FORCEPS ULRICH.....	248
BECKMANN RETRACTORS.....	176	BLADEBREAKER CASTROVIEJO.....	45	BONE HOLDING FORCEPS VAN BUREN.....	249
BECKMANN-ADSON RETRACTORS.....	175	BLADEBREAKER REDA.....	45	BONE HOLDING FORCEPS VERBRUGGE.....	245
BECKMANN-EATON RETRACTORS.....	176	BLADEBREAKER TROUTMAN-CHRIS.....	45	BONE KNIVES.....	44
BED PAN.....	621	BLADE-REMOVER.....	42	BONE LEVERS.....	284, 288
BEEBEE CROWNSCISSORS.....	68	BLADES RAZOR.....	45	BONE LEVERS BENNETT.....	283
BEER CLIA FORCEPS.....	395	BLAKE GALL STONE FORCEPS.....	531	BONE LEVERS BLOUNT.....	288
BEESON PLASTER RETRACTOR.....	232	BLAKE UTERINE CURETTE.....	595	BONE LEVERS HOHMANN.....	284
BELLUCCI MICRO-EAR SCISSORS.....	413	BLOHMKE TONSIL FORCEPS.....	467	BONE LEVERS HOHMANN.....	285
BELLUCCI MICRO-SCISSORS.....	417	BLOOD VESSEL CLAMP DIETRICH.....	510	BONE LEVERS HOHMANN MINI.....	286
BENDER.....	322	BLOOD VESSEL CLAMP MORRIS-DEBAKEY.....	506	BONE LEVERS KOENIG.....	284
BENDER LANE.....	325	BLOOD VESSEL CLAMP WEBER.....	501	BONE LEVERS LANGE-HOHMANN.....	286
BENGOLEA HEMOSTATIC CLAMP.....	112	BLOWNT BONE LEVERS.....	288, 289	BONE LEVERS SMILLIE.....	291
BENNETT BONE LEVERS.....	283	BLOWER KABIERSKE.....	405	BONE LEVERS VERBRUGGE-MÜLLER.....	287
BENSAUDE PROCTOSCOPE.....	565	BLUMENTHAL BONE RONGEUR.....	236	BONE PLATE HOLDING FORCEPS LANE.....	325
BENSON PYLORUSRETRACTOR.....	544	BODENHAMMER RECTAL-SPECULA.....	559	BONE RONGEUR ADSON.....	236
BERENS DISCISION KNIVES.....	372	BOEHLER EXTENSION BOW.....	312	BONE RONGEUR BANE-HARTMANN.....	237
BERGMANN BANDAGE SCISSORS.....	69/1	BOERMA OBSTETRICAL FORCEPS.....	604	BONE RONGEUR BEYER.....	237, 238
BERGMANN HAMMER.....	272	BOETTCHER TONSIL SCISSORS.....	59	BONE RONGEUR BLUMENTHAL.....	236
BERKE MUSCLE FORCEPS.....	389	BÖHLER BONE CUTTING FORCEPS.....	241	BONE RONGEUR BOEHLER.....	238
BERLINER PERCUSSION HAMMER.....	24	BÖHLER BONE RONGEUR.....	238	BONE RONGEUR CLEVELAND.....	235
BERNHARD TOWEL CLAMP.....	133	BOIES ELEVATOR.....	277	BONE RONGEUR ECHLIN.....	240
BERRY WIRE FORCEPS.....	319	BONACCOLTO STRABISMUS FORCEPS.....	385	BONE RONGEUR FRIEDMAN-MICRO.....	234
BETHUNE RIB SCISSORS.....	481	BONE CURETTES.....	255, 256	BONE RONGEUR FRIEDMAN-MINI.....	234
BEYER BONE RONGEUR.....	237, 238	BONE CURETTES BRUNS.....	251, 254	BONE RONGEUR FRYKHOLM.....	240
BIEMER APPLIER FORCEPS.....	361, 366	BONE CURETTES BUSHE.....	256	BONE RONGEUR JANSEN.....	237
BIEMER APPROXIMATOR.....	366	BONE CURETTES DAUBENSPECK.....	255	BONE RONGEUR KLEINERT-KUTZ.....	237
BIEMER VASCULAR CLIP.....	361	BONE CURETTES HALLE.....	253	BONE RONGEUR LEMPERT.....	237
BIEMER-MÜLLER APPROXIMATOR.....	363	BONE CURETTES JACOBSON.....	257	BONE RONGEUR LUER.....	236
BIER AMPUTATION SAW.....	296	BONE CURETTES JANSEN.....	257	BONE RONGEUR MARQUARD.....	239
BILLEAU EAR LOOP.....	409	BONE CURETTES LEMPERT.....	256	BONE RONGEUR MAYFIELD.....	238
BIOPSY CURETTE HEANY.....	587	BONE CURETTES MARTINI.....	257	BONE RONGEUR MEAD.....	235
BIOPSY CURETTE KEVORKIAN.....	587	BONE CURETTES SCHEDE.....	251	BONE RONGEUR OLIVECRONA.....	237
BIOPSY CURETTE NOVAK.....	587	BONE CURETTES SCOVILLE.....	253	BONE RONGEUR RUSKIN.....	239
BIOPSY CURETTE RANDALL.....	587	BONE CURETTES SPINAL.....	253	BONE RONGEUR SAUERBRUCH.....	240
BIOPSY CURETTE TYPE MÜNCHEN.....	587	BONE CURETTES SPRATT.....	251	BONE RONGEUR SCAGLIETTI.....	240
BIOPSY FORCEPS ALEXANDER.....	589	BONE CURETTES VOLKMANN.....	251, 257	BONE RONGEUR SEMB.....	240
BIOPSY FORCEPS BABY BURKE.....	590	BONE CURETTES WILLIGER.....	255, 257	BONE RONGEUR SMITH-PETERSEN.....	238
BIOPSY FORCEPS BURKE.....	590	BONE CUTTING FORCEPS BOEHLER.....	241	BONE RONGEUR STELLBRINK.....	234
BIOPSY FORCEPS EPPENDORFER.....	590	BONE CUTTING FORCEPS LISTON.....	241	BONE RONGEUR ZAUFAL-JANSEN.....	238
BIOPSY FORCEPS FAURE.....	588	BONE CUTTING FORCEPS MCINDOE.....	241	BONE RONGEURLEKSELL-STILLE.....	240
BIOPSY FORCEPS KERVORKIAN-PACIFIC.....	592	BONE CUTTING FORCEPS RUSKIN.....	241	BONE RONGEURSTILLE-LUER.....	239
BIOPSY FORCEPS KEVORKIAN.....	589	BONE CUTTING FORCEPS SEMB.....	242	BONE RONGEURSTILLE-RUSKIN.....	239
BIOPSY FORCEPS KEVORKIAN.....	591	BONE CUTTING FORCEPSCOTTLE-K.....	241	BONEFENDER NAIL BENDER.....	322
BIOPSY FORCEPS MAXI GRASPER.....	593	BONE CUTTING FORCEPSSTILLE.....	241, 242	BONEHOOK VOLKMANN.....	156
BIOPSY FORCEPS SCHUBERT.....	588	BONE FILES.....	612/1	BONERASP.....	294
BIOPSY FORCEPS SCHUMACHER.....	588, 589	BONE HAND DRILLS BUNELL.....	299	BONERASP PUTTI.....	294
BIOPSY FORCEPS THOMAS-GAYLOR.....	588	BONE HAND DRILLS HUDSON.....	299	BONEWIRE SOFT.....	314
BIOPSY FORCEPS TISCHLER-DOWN.....	591	BONE HAND DRILLS KIRSCHNER.....	299	BONN IRIS TISSUE FORCEPS.....	387
BIOPSY FORCEPS TISCHLER-KERVORKIAN.....	592	BONE HAND DRILLS MOORE.....	298	BONNEY ANATOMIC TISSUE FORCEPS.....	88
BIOPSY FORCEPS TISCHLER-MORGAN.....	591	BONE HAND DRILLS RALK.....	300	BONNEY SURGICAL TISSUE FORCEPS.....	88
BIOPSY FORCEPS TOWNSEND MINI.....	591	BONE HAND DRILLSSTILLE.....	298	BOSE TRACHEA HOOK.....	476, 477
BIOPSY FORCEPS TOWNSEND TISCHLER MINI.....	591	BONE HAND DRILLSSTILLE-SHERMAN.....	298	BOUCHERON EAR SPECULA.....	399
BIOPSY FORCEPS VAN DOREN.....	588	BONE HOLDING CLAMP FELDHEIM.....	249	BOWEL CLAMP BABY-KOCHER.....	540
BIOPSY FORCEPS WITNER.....	589	BONE HOLDING CLAMP GERSTER.....	250	BOWEL CLAMP BRUNNER.....	543
BIOPSY FORCEPSTISCHLER-MORGAN.....	590	BONE HOLDING CLAMP LAMBERT-LOWMAN.....	249	BOWEL CLAMP DOYEN.....	540
BIOPSY NEEDLE MENGHINI.....	206	BONE HOLDING CLAMP LOWMAN.....	249	BOWEL CLAMP FEHLAND.....	542
BIOPSY NEEDLEFRANKLIN-SILVERMANN.....	206	BONE HOLDING CLAMP LOWMAN-HOGLUND.....	249	BOWEL CLAMP KOCHER.....	540
BIOPSY-/SUCTION CURETTE.....	600	BONE HOLDING FORCEPS.....	249	BOWEL CLAMP MAYO-ROBSON.....	541

BOWEL CLAMP PAYR	548	BRUNNER RIB SCISSORS	481	CATARACT KNIVES DEUTSCHMANN	371
BOWEL CLAMP RESANO	542	BRUNS BANDAGE SCISSORS	70	CATARACT KNIVES GRAEFE	371
BOWEL CLAMP SCUDDER	541	BRUNS BONE CURETTES	251, 254	CATARACT LOOP ARLT	378
BOWEL CLAMPSTONE-WATT	545	BRUSH DISPENCOR	611	CATARACT LOOP SNELLEN	378
BOWEL GRASPING FORCEPS ALLIS	537	BRYANT DRESSINGFORCEPS	137	CATARACT LOOP WEBER	378
BOWEL GRASPING FORCEPS ALLIS-ADAIR	537	BUCHWALD TONGUE DEPRESSORS	451	CATARACT LOOP WILDER	378
BOWEL GRASPING FORCEPS ALLIS-BABY	537	BUCK EAR CURETTE	407	CATHETER INTRODUCING FORCEPS MAGILL	28
BOWEL GRASPING FORCEPS ATRAUMA	111	BUCK FOREIGN-BODY LEVER	412	CATHETER FORCEPS COOLEY	510
BOWEL GRASPING FORCEPS BABCOCK	539	BUCK PERCUSSION HAMMER	24	CATHETER GUIDE GUYON	554
BOWEL GRASPING FORCEPS COLLIN	539	BUCK-GRAMCKO BONE LEVERS	285	CATLIN AMPUTATION KNIVES	44
BOWEL GRASPING FORCEPS DOYEN-BABY	540	BUCK-GRAMCKO BONE LEVERS	285	CAUTER WADSWORTH-TODD	378
BOWEL GRASPING FORCEPS DUVAL	539	BUIE RECTAL ABSUCTION TUBE	566	CERVICAL TRACTION TONG CRUTCHFIELD	327
BOWEL GRASPING FORCEPS JUDD-ALLIS	538	BULLDOG CLAMP ATRAUMA	100	CHALAZIO CURETTE AXENFELD	377
BOWEL GRASPING FORCEPS LITTLEWOOD	538	BULLDOG CLAMP DEBAKEY	100, 103	CHALAZIO CURETTE HEBRA	377
BOWEL GRASPING FORCEPS LOCKWOOD-ALLIS	538	BULLDOG CLAMP DIETRICH	101	CHALAZIO CURETTE MEYHOEFER	377
BOWEL GRASPING FORCEPS THOMS-ALLIS	538	BULLDOG CLAMP GLOVER	103	CHALAZIO TISSUE FORCEPS AVER	393
BOWEL GRASPING FORCEPS WILLIAMS	539	BULLDOG CLAMP JOHNS-HOPKINS	104	CHALAZIO TISSUE FORCEPS DESMARRES	393
BOWEL SPATULA HABERER	143/1	BÜLOW-GUNAR-HEY TUBINGCLAMP	130	CHALAZIO TISSUE FORCEPS LAMBERT	393
BOWEL SPATULA LERICHE	143/2	BUMM UTERINE CURETTE	597	CHAPUT TISSUE GRASPING FORCEPS	110
BOWEL SPATULA REVERDIN	143/1	BUNELL BONE HAND DRILLS	299	CHARNLEY ABDOMINALRETRACTORS	289
BOWEL SPATULA RIBBON	143	BUNELL TENDON GUIDE	294	CHARRIERE AMPUTATION SAW	296
BOWMAN DISCISION KNIVES	372	BUNELL TENDON PASSING INSTR.	292	CHEATLE STERILIZATION FORCEPS	227
BOWMAN DISCISION NEEDLE GERADE	374	BUNGE EXENTERATIONS	378	CHEEK RETRACTORSTERNBERG	453
BOWMAN EYE SPECULA	370	BUNT STERILIZATION CLAMP	227	CHEEKSTEIN NEEDLE HOLDER	210
BOWMAN LACHRYMAL PROBES	381	BURCH FIXATION FORCEPS	373	CHELSEA-EATON PROCTOSCOPE	563
BOX PETRI	620	BURKE BIOPSY FORCEPS	590	CHERON DRESSINGFORCEPS	137
BOYNTON NEEDLE HOLDER	214	BUSCH EPISIOTOMY SCISSORS	64	CHERRY LAMINECTOMY RETRACTOR	488
BOZEMANN DRESSINGFORCEPS	138	BUSHE BONE CURETTE	256	CHEST SUPPORT KLEINSASSER	36
BOZEMANN NEEDLE HOLDER	211	BUTTONPROBES JACOBSON	335	CHEVALIER-JACKSON	473
BOZEMANN-DOUGLAS DRESSINGFORCEPS	138			CHEVALIER-JACKSON TRACHEA CANNULA	479
BRAIN KNIVES	48	C		CHILDE CLIP FORCEPS	224
BRAIN SPATULA DAVIS	337	CABLE BIPOLAR	633	CHILDREN ATRAUMA VASCULAR CLAMP	526
BRAINSPATULA CUSHING	336	CALIPER TOWNLEY	26	CHISEL NEIVERT-ANDERSON	442
BRAINSPATULA CUSHING	369	CALIPERS	26	CHISELS	259, 264
BRAINSPATULA HEIFETZ	369	CANFIELD TONSIL-KNIVES	466	CHISELS ALEXANDER	259
BRAINSPATULA OLIVECRONA	336	CANNULA	406	CHISELS BRUNETTI	268
BRAND TENDON GRASPING INSTRUMENT	293	CANPLAN NOSE FORCEPS	428	CHISELS COTTLE	440
BRAND TENDON PASSING INSTR.	294	CAPSULA SCISSORS RESANO	53/2	CHISELS HIBBS	265
BRAUN CRANIPLAST	607	CAPSULAR FORCEPS ARRUGA	391	CHISELS HOKE	265
BRAUN DECAPITATING HOOK	607	CAPSULAR FORCEPS CASTROVIEJO	391	CHISELS KILLIAN	442/1
BRAUN HOOK FORCEPS	582	CAPSULAR FORCEPS ELSCHNIG	391	CHISELS LAMBOTTE	261
BRAUN UTERINE-DEPRESSOR	586	CAPSULAR FORCEPS FUCHS	391	CHISELS LEXER	263
BRAUN-STADLER EPISIOTOMY SCISSORS	64	CAPSULAR FORCEPS GILL-ARRUGA	390	CHISELS MINI-LAMBOTTE	262
BREAST RETRACTOR	198	CAPSULAR FORCEPS HESS	391	CHISELS NOVOTEX	264
BREISKY VAGINAL SPECULA	577	CAPSULAR FORCEPS KALT	391	CHISELS OBWEGESER	463
BREITEN-MEASURING INSTRUMENT	594	CAPSULAR FORCEPS SCHWEIGGER	391	CHISELS SMITH-PETERSEN	261
BRIDGE HEMOSTATIC CLAMP	116	CAPSULAR FORCEPS TERSON	391	CHISELSBLADE	266
BRISTOW BONE LEVERS	290	CAPSULAR GRASPING FORCEPS MILLIN	551	CHISELSSTILLE	260
BRISTOW BONE LEVERS	290	CARDIOVASCULAER CLAMP	526	CILIA FORCEPS BARRAQUER	395
BRODIE PROBES	199	CARMALT SPLINTER TISSUE FORCEPS	91	CILIA FORCEPS BEER	395
BRONCHO.FORCEPS CHEVALIER-JACK	473	CAROLL TENDON GRASPING INSTRUMENT	293	CILIA FORCEPS DOUGLAS	395
BRONCHUS CLAMP	126	CAROTIS-SHUNT CLAMP JAVID	511	CILIA FORCEPS GRADLE	395
BRONCHUSCLAMP FINOCCHIETTO	490	CARPENTER TONSIL KNIVES	465	CILIA FORCEPS LITTAUER	395
BRONCHUSCLAMP HARRINGTON	490	CARTILAGE KNIVES	47	CILIA FORCEPS REDA	395
BRONCHUSCLAMP LEES	504	CASPAR HEMOSTATS	258	CINELLI SEPTUM CHISELS	441
BRONCHUSCLAMP PRICE-THOMAS	490	CASPAR RETRACTORS	179, 180	CIRCULAR RONGEUR	432
BRONCHUSCLAMP SEMB	491	CASTANEDA NEONATAL VASCULAR CLAMP	527	CIRCUMCISIONS INSTRUMENT	556
BROPHY ANATOMIC TISSUE FORCEPS	84	CASTROVIEJO PROBE	381	CITELLI RONGEUR	430
BROPHY SURGICAL TISSUE FORCEPS	84	CASTROVIEJO BLADEBREAKER	45	CLAMP VASEKTOMIE	553/2
BROWN NEEDLE HOLDER	209	CASTROVIEJO CAPSULAR FORCEPS	391	CLAMPHOLDING	326
BROWN TISSUE FORCEPS	83	CASTROVIEJO CYCLODIALYSIS SPATULA	379	CLAR HEAD LIGHTS	22
BRUENINGS	468, 472	CASTROVIEJO DISCISION KNIVES	372	CLARK EYE SPECULA	370
BRUENINGS EAR SPECULA	401	CASTROVIEJO EYE SPECULA	371	CLAUS TONSIL NEEDLE	466
BRUENINGS INTERCHANGEABLE TIPS	472	CASTROVIEJO FIXATION FORCEPS	390	CLAYMAN	376
BRUENINGS SEPTUM FORCEPS	425	CASTROVIEJO HORNYSKINSCISSORS	79	CLAYMAN HOOK	376
BRUENINGS TONGUE DEPRESSORS	451	CASTROVIEJO MEASURANCE CIRCLE	380	CLEANING PISTOL	626
BRUENINGS TONSIL-KNIVES	466	CASTROVIEJO NEEDLE HOLDER	215	CLEVELAND BONE RONGEUR	235
BRUNETTI CHISELS	268	CASTROVIEJO TISSUE FORCEPS	392	CLIP FORCEPS CHILDE	224
BRÜNING-S-LUCAS CHISELS	260	CASTROVIEJO MICRO NEEDLE HOLDER	215	CLIP FORCEPS COLLIN	224
BRUNNER BOWEL CLAMP	543	CASTROVIEJO-STANDARD NEEDLE HOLDER	216	CLIP FORCEPS MICHEL	224
BRUNNER GUIDEPROBES	221	CATARACT CURETTE DAVIEL	377	CLIP FORCEPSRICHTER-HEATH	224
BRUNNER GUIDEPROBES	221	CATARACT CURETTE GRAEFE	377	CLIP MICHEL	224
BRUNNER RETRACTOR	167	CATARACT CURETTE KNAPP	378	CLIP TISSUE FORCEPS HEGENBARTH	224

CLIP TISSUE FORCEPS MICHEL.....	224	COTTLE FIXATION FORCEPS.....	410	D	
CLIP TISSUE FORCEPS WACHENFELDT.....	224	COTTLE HAMMER.....	273	DANDY HEMOSTATIC CLAMP.....	109
CLIP-APPLIER FORCEPS.....	523, 524	COTTLE NOSE HOOK.....	447, 447/1	DANDY NERVE HOOK.....	328
CLOWARD LAMINA SPREADER.....	339	COTTLE NOSE SCISSORS.....	59	DARLING RETRACTORS.....	178
CLOWARD LAMINECTOMY RETRACTOR FORCEPS.....	342	COTTLE NOSE SPECULA.....	423	DARTIGUES UTERINE-GRASPING FORCEPS.....	585
CLOWARD RETRACTORS.....	178	COTTLE SCISSORS.....	56	DASTOOR STRABISMUS FORCEPS.....	386
COAKLEY ANTRUM CURETTE.....	449	COTTLE SEPTUM CHISELS.....	440	DASTOOR SUCTION TUBE.....	380
COAKLEY TROCAR.....	204	COTTLE SEPTUM ELEVATOR.....	439	DAUBENSPECK BONE CURETTES.....	255
COBB CURETTE.....	252	COTTLE SEPTUM KNIVES.....	435	DAVIDSON(SCAPULA) RETRACTOR.....	166
COBB GOUGES.....	262	COTTLE SKIN HOOK.....	447, 448	DAVIEL CATARACT CURETTE.....	377
COBB RASPATORIES.....	280	COTTLE-JOSEPH SEPTUM.....	439	DAVIS BRAIN SPATULA.....	337
COLCLOUGH INTERVERTEBRAL DISC RONGEUR.....	344/1	COTTLE-KAZANJIAN BONE CUTTING FORCEPS.....	241	DAVIS DURA DISSECTOR.....	379
COLD LIGHT GUIDE HOLLINGER.....	37	COTTLE-NEIVERT.....	448	DAVIS FOREIGN-BODY NEEDLE.....	374
COLD LIGHT GUIDE JACKSON.....	37	COTTON-APPLICATOR.....	230	DAVIS STERILIZATION TISSUE FORCEPS.....	227
COLD LIGHT CLAMP FOR AMNIOSCOPE.....	601	COTTON-APPLICATOR FARRELL.....	203	DAVIS-BOYLE.....	455
COLLER-CRILE HEMOSTATIC CLAMP.....	106	COTTON-APPLICATOR JOBSON-HORNBYE.....	203	DAVIS-BOYLE SPERRE.....	455
COLLIER NEEDLE HOLDER.....	208	COTTON-APPLICATOR REDA.....	203	DAVIS-MEYER MOUTH GAG.....	457
COLLIER PELVIMETER.....	605	COTTON-APPLICATOR TOBOLD.....	203	DAY HOOK.....	409
COLLIN ABDOMINAL RETRACTORS.....	190	COTTON-APPLICATOR UCKERMANN.....	203	DE BAKEY NEEDLE HOLDER.....	210
COLLIN BOWEL GRASPING FORCEPS.....	539	COXETER METAL CATHETER.....	555	DE BAKEY VASCULAR CLAMP.....	494
COLLIN CLIP FORCEPS.....	224	CRAFOOD-SELLORS HEMOSTATIC CLAMP.....	118	DE BAKEY VASCULAR CLAMP.....	495
COLLIN DRESSING FORCEPS.....	137	CRAFOORD HEMOSTATIC CLAMP.....	118	DE BAKEY VASCULAR SCISSORS.....	60, 61
COLLIN DYNAMOMETER.....	25	CRAFOORD LUNG SCISSORS.....	65/2	DE BAKEY VASCULAR-DILATOR.....	529
COLLIN HAMMER.....	270	CRANIPLAST BRAUN.....	607	DE BOER RIB SPREADER.....	486
COLLIN LOKTITE ABDOMINALDE.....	191	CRANIPLAST TARNIER.....	607	DE LEE OBSTETRICAL FORCEPS.....	602
COLLIN NAVELSTRING CLAMP.....	605	CREGO ELEVATOR.....	282	DE MARTEL GUIDE SLEEVE.....	330
COLLIN PELVIMETER.....	605	CRILE HEMOSTATIC CLAMP.....	107	DE MARTEL-WOLFSON.....	546
COLLIN RETRACTOR.....	139	CRILE NEEDLE HOLDER.....	213	DEAN IRIS KNIVES.....	372
COLLIN SCALPEL-HANDLE.....	40	CRILE NERVE HOOK.....	328	DEAN TONSIL SCISSORS.....	59
COLLIN TISSUE GRASPING FORCEPS.....	110	CRILE RETRACTOR.....	140	DEAVER DISSECTING SCISSORS.....	52
COLLIN TONGUE FORCEPS.....	453	CRILE-MURRAY NEEDLE HOLDER.....	209	DEAVER RETRACTOR.....	145
COLLIN UTERINE-GRASPING FORCEPS.....	585	CRILE-RANKIN HEMOSTATIC CLAMP.....	107	DEAVER-GRIP RETRACTOR.....	146
COLLIN UTERINE-PROBES.....	586	CRILE-WOOD NEEDLE HOLDER.....	209	DEBAKEY AORTIC-ANAST.CLAMP.....	505
COLLIN VAGINAL SPECULA.....	570	CRITCHETT EYE SPECULA.....	370	DEBAKEY ATRAUMA BULLDOG CLAMP.....	100, 103
COLLIN-DUVAL GRASPING PINZE.....	85	CROWN SCISSORS BEEBEE.....	68	DEBAKEY ATRAUMA CLAMP.....	100
COLLIN-HARTMANN RETRACTOR.....	141	CRUTCHFIELD HEAD HOLDER.....	327	DEBAKEY ATRAUMA CLAMP.....	103
COLUMELLA TISSUE FORCEPS COTTLE.....	448	CRUTCHFIELD CERVICAL TRACTION TONG.....	327	DEBAKEY ATRAUMATIC TISSUE FORCEPS.....	99
COLVER TONSIL FORCEPS.....	467	CUFF FOR LEG.....	295	DEBAKEY RETRACTOR.....	189/1
COMEDONE EXTRACTOR SAALFELD.....	608	CUFF FOR UPPER ARM.....	295	DEBAKEY SUCTION TUBE.....	28
COMEDONE EXTRACTOR SCHAMBERG.....	608	CULLER IRIS SPATULA.....	378	DEBAKEY VASCULAR CLAMP.....	507, 514, 515, 516
COMEDONE EXTRACTOR UNNA.....	608	CUP MEDICINE.....	621	DEBAKEY VASCULAR SCISSORS.....	61
COMEDONE EXTRACTOR WALTON.....	608	CUP SPUTUM.....	621	DEBAKEY VASCULAR SCISSORS TC.....	60
COMPRESSION BANDAGE.....	296	CURETTE ANTRUM.....	435	DEBAKEY-BAHNSON ANEURYSM CLAMP.....	506
CONE CURETTE.....	280	CURETTE COBB.....	252	DEBAKEY-DIETRICH MINI BULLDOG CLAMP.....	101
CONE HEAD PUNCH.....	331	CURETTE FAULKNER.....	449	DEBAKEY-MOSQUITO HEMOSTATIC CLAMP.....	509
CONE RASPATORIES.....	280	CURETTE FORCEPS.....	416	DEBAKEY-PEAN ATRAUMA CLAMP.....	513
CONNIN-AMSLER MARKERS.....	380	CURETTE HOUSE.....	420	DEBAKEY-RANKIN ATRAUMA CLAMP.....	512
CONVERSE NOSE HOOK.....	448	CUSCO VAGINAL SPECULA.....	570	DECAPITATING HOOK BRAUN.....	607
CONVERSE SEPTUM KNIVES.....	435	CUSHING (TAYLOR) TISSUE FORCEPS TC.....	87	DEJERINE PERCUSSION HAMMER.....	24
COOLEY ANASTOMOSIS CLAMP.....	519, 520	CUSHING ANATOMIC TISSUE FORCEPS.....	83	DELEE RETRACTOR.....	574
COOLEY AORTIC DILATOR.....	528	CUSHING BRAIN SPATULA.....	336, 369	DEMEL WIRE GUIDE NEEDLE.....	315
COOLEY CATHETER FORCEPS.....	510	CUSHING DRILL.....	299	DEMEL WIRE INSTRUMENT.....	315
COOLEY RETRACTOR.....	148	CUSHING LAMINECTOMY RETRACTOR FORCEPS.....	340	DENHART MOUTH GAGS.....	454
COOLEY RIB SPREADER.....	487	CUSHING NERVE ENHOOK.....	328	DENIS-BROWNE ABDOMINAL RETRACTORS.....	186
COOLEY VASCULAR CLAMP.....	518, 522	CUSHING RETRACTOR.....	152	DERF NEEDLE HOLDER.....	208
COOLEY-DERRA ANASTOMOSIS CLAMP.....	519	CUSHING RETRACTOR.....	153	DERMATOM HUMBY.....	50
COOLEY-NEONATAL RIB SPREADER.....	485	CUSHING RETRACTOR.....	151, 152, 153	DERMATOM SILVER.....	50
COOLY SUCTION TUBE.....	28	CUSHING SURGICAL TISSUE FORCEPS.....	83	DERMATOME SCHINK.....	49
COOPER LIGATUREE NEEDLE.....	219	CUSHING TISSUE FORCEPS.....	87	DERMATOME BLADE.....	49
CORDES INTERCHANGEABLE TIPS.....	472	CUSHING-TAYLOR ANATOMIC TISSUE FORCEPS.....	87	DESCHAMPS LIGATUREE NEEDLE.....	218
CORNEAL DISSECTOR GREEN.....	374	CUZZI OVUM CURETTE.....	606	DESJARDINS GALL STONE.....	532
CORNEAL DISSECTOR PATON.....	373	CYCLODIALYSIS SPATULA BANGERTER.....	379	DESJARDINS GALL STONE CURETTE.....	534
CORNEAL SCARIFIER ELSCHNIG.....	373	CYCLODIALYSIS SPATULA CASTROVIEJO.....	379	DESJARDINS GALL STONE FORCEPS.....	531
CORNEAL SCARIFIER GILL.....	373	CYCLODIALYSIS SPATULA ELSCHNIG.....	379	DESJARDINS HEMOSTATIC CLAMP.....	121
CORNEAL SCARIFIER SATO.....	373	CYCLODIALYSIS SPATULA WHEELER.....	379	DESMARRES CHALAZIO TISSUE FORCEPS.....	393
CORNEAL SCARIFIER TOOK.....	373	CYSTOTOM BECKER.....	375	DESMARRES RETRACTOR.....	151
CORNEAL SCLEROTOME KUHN.....	373	CYSTOTOM GRAEFE.....	375	DEUTSCHMANN CATARACT KNIVES.....	371
CORONAL BROW RETRACTOR.....	198	CZERNY HOOK FORCEPS.....	584	DEVILBISS HEAD FORCEPS.....	332
CORWIN-HEGAR WIRE FORCEPS.....	319	CZERNY RECTAL-SPECULA.....	559	DIAGNOSTIC SET ECO "C".....	16
CORYLLOS RETRACTOR.....	166			DIAGNOSTIC SET ECO "T".....	16
CORYLLOS RIB SCISSORS.....	480			DIAGNOSTIC SET RI-MINI.....	17
COS MICRO-EAR FORCEPS.....	414			DIAGNOSTIC SET UNI III.....	15
COTTLE COLUMELLA TISSUE FORCEPS.....	448			DIFFENBACH VASCULAR CLAMP.....	104

DIETER MICRO-EAR FORCEPS.....	414	DRESSINGFORCEPS FOERSTER.....	136	EARSYRINGE REINER.....	406
DIETRICH BLOOD VESSEL CLAMP.....	510	DRESSINGFORCEPS GROSS-MAIER.....	134	ECHLIN BONE RONGEUR.....	240
DIETRICH MINI-BULLDOG CLAMP.....	101	DRESSINGFORCEPS LISTER (SINUS).....	137	ECO "C" DIAGNOSTIC SET.....	16
DIETRICH VASCULAR SCISSORS.....	60	DRESSINGFORCEPS M.SPERRE.....	135	ECO "T" DIAGNOSTIC SET.....	16
DILATION BOUGIE DITTEL.....	554	DRESSINGFORCEPS MAIER.....	134	EICKEN (KILLIAN) IRRIGATION CANNULA.....	433
DILATION BOUGIE GUYON.....	554	DRESSINGFORCEPS PELKMANN.....	137	ELEVATOR ALDERDYCE.....	282
DILATION BOUGIE VAN BUREN.....	554	DRESSINGFORCEPS RAMPLEY.....	136	ELEVATOR BOIES.....	277
DINGMANN BONE HOLDING FORCEPS.....	246	DRESSINGFORCEPS SIMS-MAIER.....	134	ELEVATOR CREGO.....	282
DINGMANN MOUTH GAGS.....	456	DRESSINGFORCEPS ULRICH.....	135	ELEVATOR DINGMANN.....	463, 463/3
DINGMANN RASPARTORIES.....	463	DRESSINGTISSUE FORCEPS JACKSON.....	471	ELEVATOR KEY.....	282
DINGMANN RETRACTOR.....	463	DRILL.....	299	ELEVATOR LEMPERT.....	420
DINGMANN SPREADER.....	456	DRILL BITS.....	302	ELEVATOR LUNIATSCHEK.....	465
DIPLOMAT SPHYGMOMANOMETER.....	5	DRILL CUSHING.....	299	ELEVATOR MCDONALD.....	283
DISCISION KNIVES BERENS.....	372	DRILL ERRICO.....	299	ELEVATOR MURPHY-LANE.....	283
DISCISION KNIVES BOWMAN.....	372	DRILL MC KENZIE.....	299	ELEVATOR SAYRE.....	281
DISCISION KNIVES CASTROVIEJO.....	372	DRILL SUPPORT.....	310	ELEVATOR WATSON-CHEVNE.....	283
DISCISION KNIVES JAEGER.....	372	DRILL WIRE.....	299	ELEVATORIUM FREER.....	434
DISCISION KNIVES WHEELER.....	373	DRILLWIRE KIRSCHNER.....	306, 307	ELLIOT OBSTETRICAL FORCEPS.....	602
DISCISION KNIVES WHEELER.....	373	DRIVER KUENTSCHER.....	321	ELJIS FOREIGN-BODY GOUGES.....	374
DISCISION NEEDLE.....	374	DRIVERS.....	321	ELSCHING CAPSULAR FORCEPS.....	391
DISCISION NEEDLE BOWMAN.....	374	DUBOIS GYNECOLOGICAL SCISSORS.....	63	ELSCHING CORNEAL SCARIFIER.....	373
DISSECTING SCISSORS.....	52	DUEHRSEN ANATOMIC TISSUE FORCEPS.....	84	ELSCHING CYCLODIALYSIS SPATULA.....	379
DISSECTING SCISSORS.....	53/2	DUPLAY DRESSINGFORCEPS.....	134	ELSCHING FIXATION FORCEPS.....	389
DISSECTING SCISSORS DEAVER.....	52	DUPLAY HOOK FORCEPS.....	582	EMMETT FISTULA HOOK.....	594
DISSECTING SCISSORS JORGENSEN.....	53	DUPLEX STETHOSCOPE.....	23	ENDERNAIL STEINMANN.....	307
DISSECTING SCISSORS LEXER.....	53	DUPUY-WEISS TONSIL KNIVES.....	466	ENDOSCOPE ASSEMBLY.....	188
DISSECTING SCISSORS LEXER-BABY.....	53	DURA DISSECTOR.....	332	ENDOSCOPE WIREBASKET.....	623
DISSECTING SCISSORS LEXER-BABY TC.....	53	DURA DISSECTOR DAVIS.....	332	ENDOSPECULA KOGAN.....	577
DISSECTING SCISSORS MAYO.....	52	DURA DISSECTOR FRAZIER.....	333	ENGEL PLASTER CAST SAW.....	229
DISSECTING SCISSORS MAYO TC.....	52	DURA DISSECTOR HOEN.....	333	ENTEROTOMY SCISSORS.....	66
DISSECTING SCISSORS MAYO-NOBLE.....	52	DURA DISSECTOR HORSLEY.....	333	ENTROPION FORCEPS SNELLEN.....	393
DISSECTING SCISSORS MAYO-STILLE.....	52	DURA DISSECTOR MILLIGAN.....	332	ENUCLATION CURETTE WELLS.....	378
DISSECTING SCISSORS MAYO-STILLE.....	52	DURA DISSECTOR OLIVECRONA.....	332	ENUCLATION SCISSORS.....	58
DISSECTING SCISSORS MAYO-STILLE TC.....	52	DURA DISSECTOR SACHS.....	332	EPIGLOTTIS RETRACTOR FRAENKEL.....	471
DISSECTING SCISSORS METZENBAUM.....	53/1	DURA DISSECTOR TOENNIS.....	332	EPIGLOTTIS RETRACTOR JACKSON.....	471
DISSECTING SCISSORS METZENBAUM.....	53/1	DURA DISSECTOR TOENNIS.....	332	EPIGLOTTIS RETRACTOR REICHERT.....	471
DISSECTING SCISSORS METZENBAUM FINO.....	53/1	DURA DISSECTOR WOODSON.....	333	EPISTOMY SCISSORS WALDMANN.....	64
DISSECTING SCISSORS METZENBAUM TC.....	53/1	DURA HOOK.....	335	EPKER OSTEOTOME.....	464/2
DISSECTING SCISSORS PECK-JOSEPH.....	74	DURA HOOK JACOBSON.....	335	EPPENDORFER BIOPSY FORCEPS.....	590
DISSECTING SCISSORS TOENNIS-ADSON.....	65	DURA KNIVES KOOS.....	335	ESMARCH BANDAGE SCISSORS.....	69/2
DISSECTING SCISSORS METZENBAUM FINO TC.....	53/1	DURAHOOK ADSON.....	328	ESMARCH PLASTER KNIVES.....	233
DISSECTOR FISCH.....	420	DURANTE GRASPING TISSUE FORCEPS.....	88	ETHICON CLIP FORCEPS.....	524
DISSECTOR GORNEY.....	277	DURASCISSORS SCHMIEDEN-TAYLOR.....	65/1	EVES TONSIL SNARE.....	468
DISSECTOR PENFIELD.....	333	DUVAL BOWEL GRASPING FORCEPS.....	539	EXACTA SPHYGMOMANOMETER.....	8
DITTEL DILATION BOUGIE.....	554	DUVAL GRASPING TISSUE FORCEPS.....	85	EXENTERATION CURETTE BUNGE.....	378
DIX FOREIGN-BODY CHISELS.....	374	DYNAMOMETER COLLIN.....	25	EXTENSIONS BOWS BOEHLER.....	312
DIX FOREIGN-BODY INSTRUMENT.....	380			EXTENSIONS BOWS KIRSCHNER.....	312
DOUBLECURETTE VOLKMANN.....	257	E		EXTENSIONS BOWS KIRSCHNER US.....	312
DOUGHTY TONGUE BLADE.....	458	EAR CATHETER HARTMANN.....	408	EXTIRPATIONSCHEISLS ROLLET.....	374
DOUGLAS CILIA FORCEPS.....	395	EAR CURETTE BUCK.....	407	EXTRACTION DISSECTOR LANG.....	378
DOUGLAS TONSIL KNIVES.....	466	EAR CURETTE GROSS.....	409	EXTRACTION HOOK.....	322
DOUGLAS TROCAR.....	205	EAR FORCEPS HARTMANN.....	411	EXTRACTION HOOK KNAPP.....	375
DOYEN ABDOMINALRETRACTORS.....	189/1	EAR FORCEPS HEYMANN-KNIGHT.....	425	EXTRACTION HOOK ROLLET.....	375
DOYEN BOWEL CLAMP.....	540	EAR FORCEPS JANSEN.....	424	EXTRACTION HOOK ARRUGA.....	375
DOYEN GYNECOLOGICAL SCISSORS.....	63	EAR FORCEPS LITTAUER.....	411	EXTRAKTOR KUENTSCHER.....	322
DOYEN MYOMA A SCREW.....	594	EAR FORCEPS LUCAE.....	410	EYE CANNULA MCINTYRE.....	394
DOYEN PROBES.....	199	EAR FORCEPS TILLEY.....	411	EYE CANNULA TYPE AIR INJECTION.....	394
DOYEN RASPARTORIES.....	278	EAR FORCEPS TROELTSCH.....	424	EYE CANNULA TYPE SHEETS.....	394/2
DOYEN RETRACTOR.....	163	EAR FORCEPS WILDE (TROELTSCH).....	410	EYE MAGNET REDA.....	395
DOYEN SCISSORS.....	63	EAR KNIVES POLITZER.....	408	EYE SPECULA ARRUGA.....	370
DOYEN TOWEL CLAMP.....	133	EAR KNIVES SEXTON.....	408	EYE SPECULA BARRAQUER.....	370
DOYEN UTERINE POLYP FORCEPS.....	585	EAR LEVER ZAUFAL.....	409	EYE SPECULA BOWMAN.....	370
DOYEN VAGINAL SPECULA.....	574	EAR LEVER ZAUFAL-JANSEN.....	409	EYE SPECULA CASTROVIEJO.....	371
DOYEN-BABY BOWEL CLAMP.....	540	EAR LOOP BILLEAU.....	409	EYE SPECULA CLARK.....	370
DOYEN-JANSEN(MOLT).....	454	EAR LOOP SHAPLEIGH.....	410	EYE SPECULA CRITCHETT.....	370
DOYEN-JANSEN(MOLT) MOUTH GAGS.....	454	EAR SPECULA BOUCHERON.....	399	EYE SPECULA GRAEFE.....	370
DOYEN-STILLE REPRATOR.....	167	EAR SPECULA BRUENINGS.....	401	EYE SPECULA LANCASTER.....	371
DRESSINGFORCEPS.....	135	EAR SPECULA GRUBER.....	399	EYE SPECULA LISTER-BURCH.....	370
DRESSINGFORCEPS BOZEMANN.....	138	EAR SPECULA HARTMANN.....	399	EYE SPECULA MELLINGER.....	370
DRESSINGFORCEPS BOZEMANN-DOUGLAS.....	138	EAR SPECULA POLITZER.....	399	EYE SPECULA MELLINGER-AXENFELD.....	370
DRESSINGFORCEPS BRYANT.....	137	EAR SPECULA RICHNAU-HOLMGREN.....	400	EYE SPECULA MUELLER.....	371
DRESSINGFORCEPS CHERON.....	137	EAR SPECULA SIEGLE.....	402	EYE SPECULA MURDOCK.....	370
DRESSINGFORCEPS COLLIN.....	137	EAR SPECULA TOYNBEE.....	399	EYE SPECULA PARK.....	371

EYE SPECULA SMITH	370	FIXATION FORCEPS LESTER	389	GASS HOOK	376
EYE SPECULA WEEK	370	FIXIERFORC BURCH	373	GAUSS KOPFSCHWARTE	605
EYE SPECULA WILLIAMS	370	FIXIERVORRICHTUNG ROCHARD	186	GELPI ABDOMINALRETRACTORS	189/1, 189/2
EYE SPECULA ZIEGLER	371	FLAT FORCEPS	316, 317	GELPI HOOK	193
EYE SPECULAST.EVENSEN	371	FOERSTER DRESSINGFORCEPS	136	GEMINI HEMOSTATIC CLAMP	115
EYE SUCTION -IRRIGATION CANNULA	394	FOERSTER IRIS TISSUE FORCEPS	383	GERALD ANATOMIC TISSUE FORCEPS	86
EYESCISSORS BARRAQUER	75	FOMON NOSE RASP	444	GERALD SURGICAL TISSUE FORCEPS	87
EYESCISSORS NOYES	75	FOMON NOSE SCISSORS	58	GERSTER BONE HOLDING CLAMP	250
EYESCISSORS VANNAS	79	FOMON RASPTORIES	277	GERZOG HAMMER	270
EYESCISSORS WECKER	75	FOMON RHINOPLASTSCISSORS	65/1	GERTZ-STILLE RIB SCISSORS	481
EYESCISSORS WESTCOTT	75	FOMON SEPTUM CHISELS	441	GIGLI SAW	332
F		FOMON SKIN HOOK	447/1	GILL CORNEAL SCARIFIER	373
FACE LIFT SCISSORS FREEMAN	74	FOMON TC NOSE RASP	445	GILL IRIS TISSUE FORCEPS	384
FACE LIFT SCISSORS GORNEY	73	FOREGGER LARYNGOSCOPE	29, 31	GILL-ARRUGA CAPSULAR FORCEPS	390
FACE LIFT SCISSORS KAYE	73	FOREIGN-BODY CHISELS DIX	374	GILL-HESS IRIS TISSUE FORCEPS	384
FACE LIFT SCISSORS REES	73	FOREIGN-BODY CURETTE ALVIS	374	GILLIES NEEDLE HOLDER	212
FANSLER PROCTOSCOPE	564	FOREIGN-BODY FORCEPS HARTMANN	412	GILLIES SKIN HOOK	448
FARABEUF BONE HOLDING FORCEPS	243	FOREIGN-BODY FORCEPS HARTMANN-HOFFMANN	412	GILLIES SURGICAL TISSUE FORCEPS	86
FARABEUF RASPTORIESIES	274	FOREIGN-BODY FORCEPS HARTMANN-WULLSTEIN	412	GIL-VERNET RETRACTOR	152
FARABEUF RETRACTOR	139	FOREIGN-BODY FORCEPS MATHIEU	553/1	GLOVER ATRAUMA CLAMP	100
FARABEUF-COLLIN RASPTORIESIES	274	FOREIGN-BODY GOUGES ELLIS	374	GLOVER BULLDOG CLAMP	103
FARABEUF-LAMBOTTE BONE HOLDING FORCEPS	243	FOREIGN-BODY GOUGES WALTON	374	GLOVER VASCULAR CLAMP	515
FARRELL COTTON-APPLICATOR	203	FOREIGN-BODY INSTR. DIX	380	GLUCK RIB SCISSORS	480
FARRIOR EAR SPECULA	400	FOREIGN-BODY LEVER BUCK	412	GOELET RETRACTOR	141
FARRIOR EAR SPECULA	400	FOREIGN-BODY LEVER QUIRE	412	GOLDMANN-FOX GUMSCISSORS	67
FAULKNER CURETTE	449	FOREIGN-BODY NEEDLE	374	GOMEL MICROSURGICAL TISSUE FORCEPS	96
FAURE BIOPSY FORCEPS	588	FOREIGN-BODY NEEDLE DAVIS	374	GOMMEL MICRO-SCISSORS	80
FAURE PERITONEUMCLAMP	123	FOREIGN-BODY NEEDLE FRANCIS	374	GONIOMETER F. FINGER	25
FAVALORO VASCULAR SCISSORS	61	FOREIGN-BODY NEEDLE LA FORCE	374	GONIOMETER MOELTGEN	25
FEHLAND BOWEL CLAMP	542	FOREIGN-BODY NEEDLE LEVINSON	374	GONIOTOMY KNIVES BARKAN	373
FEILCHENFELD TISSUE FORCEPS	91	FOX LUPUS CURETTE	608	GONIOTOMY KNIVES SCHEIE	373
FELDHEIM BONE HOLDING CLAMP	249	FRAENKEL INTERCHANGEABLE TIPS	472	GOOD TONSIL SCISSORS	59
FELGUSSON BONE HOLDING FORCEPS	243	FRANCIS FOREIGN-BODY NEEDLE	374	GOODELL UTERINE DILATATOR	581
FERGUSSON FRAZIER SUCTION TUBE	337	FRANKLIN-SILVERMANN BIOPSY NEEDLE	206	GORNEY DISSECTOR	277
FERGUSSON GALL STONE CURETTE	533	FRAZIER ABDOMINALRETRACTORS	181	GORNEY FACE LIFT SCISSORS	73
FERGUSSON HAEMORRHOIDALCLAMP	109	FRAZIER DURA DISSECTOR	333	GOSSET ABDOMINALRETRACTORS	181
FERGUSSON SURGICAL SCISSORS	66	FRAZIER FUNCTION CANNULA	337	GOUGES	264
FERRIERA RETRACTOR	197	FRAZIER SKIN HOOK	149	GOUGES PARTSCH	259
FERRIS-SMITH LAMINECTOMY RETRACTOR FORCEPS	343	FREEMAN FACE LIFT SCISSORS	74	GOUGES COBB	262
FERRIS-SMITH SURGICAL TISSUE FORCEPS	85	FREEMAN RETRACTOR	198	GOUGES HIBBS	265
FERRIS-SMITH-KERRISON RONGEUR	344, 344/2	FREER ELEVATORIUM	434	GOUGES LEXER MINI	263
FIBERGLAS-LIGHT GUIDE KLEINSASSER	36	FREER SEPTUM CHISELS	439, 442	GOUGES WEST	442/1
FICHOCHIETTO-BABY RIB SPREADER	482	FREER SEPTUM ELEVATOR	437	GOUGES ZIELKE	264
FILES BONE	612/1	FREER SEPTUM KNIVES	434	GOUGESSTILLE	260
FINGER NAIL DRILL	297	FREER SKIN HOOK	448	GOURET UTERINE CURETTE	599
FINGER PROTECTOR LANGENBECK	311	FRENZEL NYSTAGMUS SPECTACLES	20	GRADLE CILIA FORCEPS	395
FINGER RING SAW REDA	297	FRENZEL TONGUE DEPRESSORS	451	GRADLE OPHTHALMOLOGIC SCISSORS	57
FINGER RING SAW WALTON	297	FRIEDMANN MINI BONE RONGEUR	234	GRADUATED MEASURE	620
FINGER-GONIOMETER	25	FRIEDMANN SPECULA	577	GRAEFE CATARACT CURETTE	377
FINGERSAW LANGENBECK	296	FRITSCH RETRACTOR	163	GRAEFE CATARACT KNIVES	371
FINOCCHIETTO BRONCHUSCLAMP	490	FRYKHOLM BONE RONGEUR	240	GRAEFE CYSTOTOM	375
FINOCCHIETTO RIB SPREADER	482	FUCHS CAPSULAR FORCEPS	391	GRAEFE DISCISION KNIVES	372
FINOCCHIETTO RIB SPREADER	482	FUCHSIG HEMOSTATIC CLAMP	113	GRAEFE DISCISION KNIVES	372
FINOCCHIETTO-BABY RIB SPREADER	482	FÜHR.PROBES BRUNNER	221	GRAEFE FIXATION FORCEPS	389
FINOCCHIETTO-BURFORD RIB SPREADER	483	FÜHR.PROBES PAYR	221	GRAEFE IRIS TISSUE FORCEPS	382
FINSIN RETRACTOR	168	FÜHR.PROBES VIENNA	221	GRAEFE SCISSORS	56
FISCH DISSECTOR	420	G		GRAEFE STRABISMUS HOOK	375
FISCH FINE HOOK	335	GALEAHOOK YASARGIL	330	GRAEFE TISSUE FORCEPS	83
FISCHER IRIS TISSUE FORCEPS	384	GALL DUCT DILATOR BAKES	532	GRAEVE HOOK	149
FISH PROBES	199	GALL STONE CURETTE DESJARDINS	534	GRAEFEE EYE SPECULA	370
FISHER TONSIL-KNIVES	466	GALL STONE CURETTE FERGUSSON	533	GRAHAM NERVE HOOK	328
FISTULA HOOK EMMETT	594	GALL STONE CURETTE LUER-KOERTE	533	GRASPING FORCEPS	316
FISTULA PROBES PRATT	563	GALL STONE CURETTE MAYO	534	GRASPING FORCEPS	415
FISTULAPROBES LOCKHART-MUMMERY	200	GALL STONE CURETTE MOOR	532	GRASPING FORCEPS LAHEY	479
FIXATION FORCEPS BARRAQUER	390	GALL STONE FORCEPS BLAKE	531	GRASPING FORCEPS MARTEL	110
FIXATION FORCEPS CASTROVIEJO	390	GALL STONE FORCEPS DESJARDINS	531	GRASPING FORCEPS PRATT	110
FIXATION FORCEPS COTTLE	410	GALL STONE FORCEPS MAYO-BLAKE	531	GRASPING FORCEPS WILLET MARTEL	110
FIXATION FORCEPS ELSCHNIG	389	GALL STONE FORCEPS MIXTER	531	GRASPING TISSUE FORCEPS COLLIN-DUAL	85
FIXATION FORCEPS GRAEFE	389	GALL STONE PROBES DESJARDINS	532	GRASPING TISSUE FORCEPS DURANTE	88
FIXATION FORCEPS GREEN	390	GALL STONE PROBES MAYO	534	GRASPING TISSUE FORCEPS DUVAL	85
		GALL STONE PROBES MOYNIHAN	532	GRASPING TISSUE FORCEPS LERCHE	83
		GALLAHER ANTRUM RASP	446	GRASPING TISSUE FORCEPS RUSS MODELL	85
				GRAVE VAGINAL SPECULA	570

GRAY HEMOSTATIC CLAMP	121	HARGIS AWL	463	HEMOSTATIC CLAMP LAHEY	120
GREEN CORNEAL DISSECTOR	374	HARGIS MANDIBULAR BODY RETRACTOR	463/6	HEMOSTATIC CLAMP LAWRENCE	119
GREEN FIXATION FORCEPS	390	HARGIS RASPATORY	463/2	HEMOSTATIC CLAMP LERICHE	111
GREEN MUSCLE HOOK	375	HARKEN AURIKELCLAMP	503	HEMOSTATIC CLAMP LOVELACE	109
GREEN RETRACTOR	160	HARMS LACHRYMAL PROBES	381	HEMOSTATIC CLAMP LOWER	120
GREEN-ARMYTAGE	605	HARMS PROBES	333	HEMOSTATIC CLAMP MAYO-GUYON	122
GREVEN MICRO-EAR FORCEPS	414	HARRINGTON BRONCHUSCLAMP	490	HEMOSTATIC CLAMP MEEKER	119
GROSS EAR CURETTE	409	HARRINGTON HOOK	193	HEMOSTATIC CLAMP MICRO-HARTMANN	104
GROSS-MAIER DRESSINGFORCEPS	134	HARRINGTON -PEMBERTON RETRACTOR	147	HEMOSTATIC CLAMP MIXTER	119, 121
GRUBER EAR SPECULA	399	HARRINGTON RETRACTOR	147	HEMOSTATIC CLAMP MIXTER-BABY	119
GUIDE DRIVER	321	HARTMANN EAR CATHETER	408	HEMOSTATIC CLAMP MOYNIHAN	121
GUIDE NEEDLE REDON	207	HARTMANN EAR SPECULA	399	HEMOSTATIC CLAMP O'SHAUGNESSY	120
GUIDEPROBES KÖNIG	221	HARTMANN FOREIGN-BODY FORCEPS	412	HEMOSTATIC CLAMP OVERHOLT	114
GUIDEPROBES BRUNNER	221	HARTMANN FOREIGN-BODY LEVER	411	HEMOSTATIC CLAMP PEAN	108
GUIDEPROBES KIRSCHNER	221	HARTMANN HEMOSTATIC CLAMP	104	HEMOSTATIC CLAMP PEAN	110
GUIDEPROBES SCHMIEDEN	221	HARTMANN IRRIGATION CANNULA	433	HEMOSTATIC CLAMP PENNINGTON	109
GUIDEPROBES SCHMIEDEN-PAYR	221	HARTMANN NOSE SPECULA	422, 427	HEMOSTATIC CLAMP PROVIDENCE-HOSPITAL	106
GUILLEN SUCTION RASPATORIES	433/1	HARTMANN POLYP FORCEPS	424	HEMOSTATIC CLAMP ROBERTS	117
GUM SCISSORS LA GRANGE	69	HARTMANN TONGUE DEPRESSORS	452	HEMOSTATIC CLAMP ROCHESTER-CARMALT	109
GUMSCISSORS GOLDMAN-FOX	67	HARTMANN TUNING FORC	403	HEMOSTATIC CLAMP ROCHESTER-OCHSNER	108
GUMSCISSORS LOCKLIN	69	HARTMANN-HALLE NOSE SPECULA	421	HEMOSTATIC CLAMP ROCHESTER-PEAN	108
GUMSCISSORS QUINBY	67	HARTMANN-HOFFMANN FOREIGN-BODY FORCEPS	412	HEMOSTATIC CLAMP RUMEL	117
GUTHRIE SKIN HOOK	149	HARTMANN-WULLSTEIN FOREIGN-BODY FORCEPS	412	HEMOSTATIC CLAMP SAROT	118
GUYON CATHETER EINGUIDE	554	HAUGH MICRO-EAR FORCEPS	414	HEMOSTATIC CLAMP S-CVD MIXTER	116
GUYON DILATION BOUGIE	554	HAYES RECTUM-ANAST.KL	545	HEMOSTATIC CLAMP SPENCER-WELLS	109
GUYON HEMOSTATIC CLAMP	122	HEAD HOLDER CRUTCHFIELD	327	HEMOSTATIC CLAMP STILLE	122
GUYON KIDNEY CLAMP	122	HEAD LIGHTS CLAR KPLT.	22	HEMOSTATIC CLAMP TOENNIS	117
GUYTON-LUNDSGAARD SKLEROTOM	373	HEAD MIRRORS ZIEGLER	21	HEMOSTATIC CLAMP WIKSTROEM	117
GYNECOLOGICAL SCISSORS DOYEN	63	HEAD PUNCH CONE	331	HEMOSTATIC CLAMP ZENKER	118
GYNECOLOGICAL SCISSORS DUBOIS	63	HEANEY HYSTERECTOMYCLAMP	126	HEMOSTATIC CLAMP OVERHOLT-BABY	114
GYNECOLOGICAL SCISSORS SIEBOLD	62	HEANEY NEEDLE HOLDER	210	HEMOSTATIC CLAMP OVERHOLT-GEISSENDÖRFER	114
GYNECOLOGICAL SCISSORS SIMS	62	HEANEY BIOPSY CURETTE	587	HEMOSTATIC CLAMP OVERHOLT-MIXTER	115
GYNECOLOGICAL SCISSORS WERTHEIM	63	HEANY RETRACTOR	164	HEMOSTATIS	259
H		HEANY-BALLENTINE HYSTERECTOMYCLAMP	127	HENKE TONSIL-ELEVATOR	465
HABERER BOWEL SPATULA	143/1	HEATH HAMMER	273	HENLEY RETRACTORS	170
HAEMORRHOIDAL LIGATOR MC GIVNEY	568	HEATH SUTURE SCISSORS	66	HENNING PLASTER RETRACTOR	232
HAEMORRHOIDALCLAMP FERGUSSON	109	HEBRA CHALAZIO CURETTE	377	HEPP-SCHEIDEL MICRO-SCISSORS	78
HAEMORRHOIDALFORCEPS HEYWOOD-SMITH	567	HEGAR UTERINE DILATOR	578, 579	HERRICK NIERENSTIELCLAMP	123
HAGLUND-STILLE PLASTER RETRACTOR	232	HEGENBARTH CLIP TISSUE FORCEPS	224	HESS CAPSULAR FORCEPS	391
HAIGHT RIB SPREADER	487	HEIFETZ BRAIN SPATULA	369	HESS IRIS TISSUE FORCEPS	384
HAJEK HAMMER	273	HEIMING KIDNEY STONE FORCEPS	536	HEYMANN SEPTUM FORCEPS	425
HAJEK SEPTUM CHISELS	442/1	HEISS HEMOSTATIC CLAMP	112	HEYMANN NOSE SCISSORS	58
HAJEK-BALLENGER ELEVATOR	439	HEISTER MOUTH GAGS	454	HEYMANN-KNIGHT EAR FORCEPS	425
HAJEK-KOFLER RONGEUR	429, 431	HEMOSTATIC CLAMP ADSON	112	HEYWOOD-SMITH HAEMORRHOIDAL FORCEPS	567
HALLE BONE CURETTES	253	HEMOSTATIC CLAMP ADSON-BABY	113	HIBBS CHISELS	265
HALLE SEPTUM ELEVATOR	437	HEMOSTATIC CLAMP BAINBRIDGE	120	HIBBS GOUGES	265
HALOGEN LAMP FOR LARYNGOSCOPE	29	HEMOSTATIC CLAMP BENGOLEA	112	HIBBS RETRACTOR	164
HALSEY NEEDLE HOLDER	208	HEMOSTATIC CLAMP BIRKETT	116	HILL-FERGUSON RECTAL-SPECULA	560
HALSTED-MOSQUITO HEMOSTATIC CLAMP	105	HEMOSTATIC CLAMP BRIDGE	116	HIRSCHMAN SPATULA	331
HAMMER	270, 272	HEMOSTATIC CLAMP COLLER-CRILE	106	HIRSCHMANN ANOSCOPE	562
HAMMER BERGMANN	272	HEMOSTATIC CLAMP CRAFOORD	118	HOEN DURA DISSECTOR	333
HAMMER COLLIN	270	HEMOSTATIC CLAMP CRAFOORD-SELLORS	118	HOESEL NEEDLE HOLDER	213
HAMMER COTTLE	273	HEMOSTATIC CLAMP CRILE	107	HOFER RETRACTOR	465
HAMMER GERZOG	270	HEMOSTATIC CLAMP CRILE-RANKIN	107	HOFFMANN TUBING CLAMP	624
HAMMER HAJEK	273	HEMOSTATIC CLAMP DANDY	109	HOHMANN BONE LEVERS	284, 285
HAMMER HEATH	273	HEMOSTATIC CLAMP DEBAKEY-MOSQUITO	509	HOHMANN MINI	286
HAMMER KIRK	270	HEMOSTATIC CLAMP DEBAKEY-PEAN	513	HOKE CHISELS	265
HAMMER LUCAE	271	HEMOSTATIC CLAMP DEBAKEY-RANKIN	512	HOLDING ARM SYSTEM LEYLA	368, 368/1, 368/3, 368/4
HAMMER MEAD	271	HEMOSTATIC CLAMP DESJARDINS	121	HOLDING CLAMP ADSON	298
HAMMER OMBREDANNE	273	HEMOSTATIC CLAMP FUCHSIG	113	HOLINGER OP-LARYNGOSCOPE	37
HAMMER PARTSCH	271	HEMOSTATIC CLAMP GEMINI	115	HOLLINGER LIGHT GUIDE	37
HAMMER QUISLING	271	HEMOSTATIC CLAMP GRAY	121	HOLSHER NERVE HOOK	329
HAMMER WILLIGER	271	HEMOSTATIC CLAMP GUYON	122	HOLTH RONGEUR	380
HÄMORRHOID.FORCEPS MCGIVNEY	568	HEMOSTATIC CLAMP HALSTED-MOSQUITO	105	HOLZBACH HYSTERECTOMYCLAMP	126
HÄMORRHOID.LIGATORRUDD	568	HEMOSTATIC CLAMP HALSTED-MOSQUITO TITANIUM	105	HOLZBACH HYSTERECTOMYCLAMP	126
HANDLE WITH JACOBS CHUCK	300	HEMOSTATIC CLAMP HARTMANN	104	HOLZHEIMER RETRACTOR	168
HANDLE ALONE	591	HEMOSTATIC CLAMP HEISS	112	HOOK	419, 475
HANDLE FOR CHISELS/CHISELS	266	HEMOSTATIC CLAMP JACOBSON	105	HOOK BALFOUR	193
HANDLE FOR CHISELS/OSTEO	266	HEMOSTATIC CLAMP JOHNS-HOPKINS	120	HOOK BARBARA	419
HANDLE SCALPEL	38, 39, 39/1, 39/2, 40, 41	HEMOSTATIC CLAMP KANTROWITZ	119	HOOK DAY	409
HANDLE SCALPEL MINI	41	HEMOSTATIC CLAMP KELLY	106	HOOK FISCH	335
HANK UTERINE DILATOR	580	HEMOSTATIC CLAMP KELLY-RANKIN	106	HOOK FORCEPS BARRET	582
		HEMOSTATIC CLAMP KOCHER	108	HOOK FORCEPS BRAUN	582

HOOK FORCEPS CZERNY.....	584	INTERCHANGEABLE TIPS KRAUSE.....	472	JEWELRY TISSUE FORCEPS.....	90
HOOK FORCEPS DUPLAY.....	582	INTERCHANGEABLE TIPS LANGE.....	472	JOBSON-HORNYE COTTON-APPLICATOR.....	203
HOOK FORCEPS HULKA.....	583	INTERCHANGEABLE TIPS SCHEINMANN.....	472	JOHNS_HOPKINS APPLIERFORCEPS.....	104
HOOK FORCEPS IOWA.....	584	INTERCHANGEABLE TIPS SCHUMACHER.....	472	JOHNS_HOPKINS BULLDOG CLAMP.....	104
HOOK FORCEPS JACOBS.....	583	INTERCHANGEABLE TIPS SEIFERT.....	472	JOHNS_HOPKINS HEMOSTATIC.....	120
HOOK FORCEPS JARCHO.....	583	INTERVERTEBRAL DISC RONGEUR COLCLOUGH.....	344/1	JOHNSON NEEDLE HOLDER.....	211
HOOK FORCEPS MUSEUX.....	583	INTRA ORAL RETRACTORS.....	463/1, 463/4	JONES TOWEL CLAMP.....	132
HOOK FORCEPS PRATT.....	584	INTRAMEDULLARY PINS.....	322	JONES-CLIP TOWEL CLAMP.....	132
HOOK FORCEPS SCHRÖDER.....	584	INZISIONSSCISSORS.....	52	JORGENSEN DISSECTING SCISSORS.....	53
HOOK FORCEPS SCHROEDER.....	583	IOWA HOOK FORCEPS.....	584	JOSEPH (LEWIS) NOSER.....	443
HOOK FORCEPS SCHROEDER (POZZI).....	582	IOWA NEEDLE GUIDE.....	206	JOSEPH NOSE RASP.....	443
HOOK FORCEPS SKENE.....	582	IRIS HOOK O'CONNOR.....	375	JOSEPH NOSESAW.....	446
HOOK FORCEPS TEALE.....	583	IRIS HOOK WIENER.....	375	JOSEPH RASPIATORIES.....	277
HOOK FORCEPSSTAUDE-MOORE.....	582	IRIS KNIVES DEAN.....	372	JOSEPH SEPTUM.....	437
HOOK GASS.....	376	IRIS KNIVES KNAPP.....	372	JOSEPH SEPTUM KNIVES.....	434
HOOK GELPI.....	193	IRIS KNIVES ZIEGLER.....	372	JOSEPH SEPTUM KNIVES.....	434, 435
HOOK HARRINGTON.....	193	IRIS SCISSORS.....	54	JOSEPH SKIN HOOK.....	149
HOOK KELLY.....	193	IRIS SCISSORS KNAPP.....	55	JOSEPH SURGICAL SCISSORS.....	54
HOOK KUGLEN IRIS.....	376	IRIS SCISSORS LITTLER.....	55	JUDD-ALLIS BOWEL GRASPING FORCEPS.....	538
HOOK LUCAE.....	409	IRIS SPATULA CULLER.....	378	JUDD-MASSON BLADDER RETRACTORS.....	552
HOOK MCGEE.....	419	IRIS SPATULA WECKER.....	378	JUERS MICRO-EAR FORCEPS.....	414
HOOK SCOVILLE.....	196	IRIS SUPERCUT SCISSORS.....	72	JURASZ LARYNGEAL POLYPUS FORCEPS.....	471
HOOK SINSKEY.....	376	IRIS TISSUE FORCEPS BARRAQUER-KATZIN.....	384		
HOOK SMELLIE.....	605	IRIS TISSUE FORCEPS BISHOP-HARMAN.....	386	K	
HOOK WAGENER.....	409	IRIS TISSUE FORCEPS BONN.....	387	KABIERSCHE POWDER BLOWER.....	405
HOOKST.EVENS.....	375	IRIS TISSUE FORCEPS FISCHER.....	384	KADER ABDOMINAL SPATULA.....	143/1
HOPKINS PLASTER KNIVES.....	233	IRIS TISSUE FORCEPS FOERSTER.....	383	KALLMORGEN SPECULA.....	573
HORIZON CLIP FORCEPS.....	524	IRIS TISSUE FORCEPS GILL.....	384	KALT CAPSULAR FORCEPS.....	391
HORNY SKIN SCISSORS CASTROVIEJO.....	79	IRIS TISSUE FORCEPS GILL-HESS.....	384	KALT NEEDLE HOLDER.....	214
HORSLEY DURA DISSECTOR.....	333	IRIS TISSUE FORCEPS GRAEFE.....	382	KALT NEEDLE HOLDER.....	214
HÖSEL RETRACTOR.....	167	IRIS TISSUE FORCEPS HESS.....	384	KALT-ARRUGA NEEDLE HOLDER.....	214
HOUSE CURETTE.....	420	IRIS TISSUE FORCEPS KIRBY-ARTHUR.....	385	KANE NAVELSTRINGCLAMP.....	605
HOUSE SUCTION TUBE.....	337/2	IRIS TISSUE FORCEPS MODELL BONN.....	387	KANTROWITZ HEMOSTATIL.....	119
HOWARTH SEPTUM ELEVATOR.....	438	IRIS TISSUE FORCEPS TROUTMAN.....	384, 389	KAYE FACE LIFT SCISSORS.....	73
HUBER UNIVERSALHANDLE.....	472	IRIS TISSUE FORCEPS TYPE TUEBINGEN.....	387	KEINASSER OP-LARYNGOSCOPE.....	35
HUDSON BONE HAND DRILLS.....	299	IRIS TISSUE FORCEPSSTEVENS.....	383	KEITH NEEDLE.....	223
HUDSON T-HANDLE.....	300	IRRIGATION CANNULA EICKEN (KILLIAN).....	433	KELLY GRIP RETRACTOR.....	142
HULKA HOOK FORCEPS.....	583	IRRIGATION CANNULA HARTMANN.....	433	KELLY HEMOSTATIC CLAMP.....	106
HUMBY DERMATOM.....	50	IRRIGATION CANNULA KILLIAN.....	433/1	KELLY HOOK.....	193
HUNTER SPLINTER FORCEPS.....	91	IRRIGATION CANNULA KILLIAN.....	433/1	KELLY PROCTOSCOPE.....	562, 563
HURD TONSIL ELEVATOR.....	465	IRRIGATION CANNULA RITTER-HALLE.....	433	KELLY RETRACTOR.....	164
HYPOPHYSE CURETTE.....	334	IRRIGATION CANNULA SIEBENMANN.....	433/1	KELLY UTERINE POLYP FORCEPS.....	585
HYPOPHYSEN FORCEPS.....	341	IRRIGATION CANNULA SIMCOE.....	394/2	KELLY VASCULAR SCISSORS.....	61
HYPOPHYSE-TISSUE FORCEPS ADSON.....	334	IRRIGATIONSCANNULA TYPE LACRIMAL.....	394	KELLY-RANKIN HEMOSTATIC CLAMP.....	106
HYSTERECTOMY FORCEPS WERTHEIM-CULLEN.....	125	ISRAEL RETRACTOR.....	162	KERATOPLAST-KNIVES BARRAQUER.....	373
HYSTERECTOMY SCISSORS WERTHEIM.....	63	ITERSON TRACHEA HOOK.....	477	KERATOPLAST-KNIVES PAUFIQUE.....	373
HYSTERECTOMYCLAMP HEANEY.....	126	IVES-FANSLER ANOSCOPE.....	562	KERN BONE HOLDING FORCEPS.....	244
HYSTERECTOMYCLAMP HEANY-BALLENTINE.....	127	IWANSON MEASURING INSTRUMENT.....	624	KERRISON RONGEUR.....	428
HYSTERECTOMYCLAMP ROGERS.....	127			KEVORKIAN BIOPSY CURETTE.....	587
HYSTERECTOMYCLAMP SEGOND.....	125	J		KEVORKIAN BIOPSY FORCEPS.....	589, 591
HYSTERECTOMYCLAMP SEGOND-LANDAU.....	125	JACKSON LARYNGOSCOPE.....	37	KEVORKIAN-PACIFIC BIOPSY FORCEPS.....	592
HYSTERECTOMYCLAMP WERTHEIM.....	124	JACKSON TENDON GRASPING FORCEPS.....	292	KEY ELEVATOR.....	282
HYSTERECTOMYCLAMP WERTHEIM.....	128	JACKSON TRACHEA HOOK.....	476	KEYES PUNCH.....	608
		JACKSON VAGINAL SPECULA.....	573	KIDNEY CLAMP GUYON.....	122
I		JACKSON-BURROWS RETRACTOR.....	189/2	KIDNEY FORCEPS HERRICK.....	123
I.A.D. EXTRAKTION HOOK.....	593	JACOBS HOOK FORCEPS.....	583	KIDNEY STONE FORCEPS HEIMING.....	536
I.A.D. GRASPING FORCEPS FLEXIBLE SERPENTINE.....	593	JACOBSON BUTTONPROBES.....	335	KIDNEY STONEFORCEPS RANDALL.....	535
ILLUMINATION ATTACHMENT.....	562	JACOBSON CURETTE.....	257	KIDNEY TRAY.....	619
IMPACTOR.....	322	JACOBSON DURA HOOK.....	335	KIELLAND OBSTETRICAL FORCEPS.....	602
IMPACTOR/EXTRACTOR.....	322	JACOBSON HEMOSTATIC CLAMP.....	105	KIELLAND-LUIKART OBSTETRICAL FORCEPS.....	603
IMPACTOR/EXTRAKTOR.....	322	JACOBSON NEEDLE HOLDER.....	215	KILLIAN GOUGES.....	442/1
INEROSSEOUSSCISSORS MCINDOE.....	65/1	JAEGER DISCISION MESSR.....	372	KILLIAN NOSE SPECULA.....	423
INGE LAMINA SPREADER.....	339	JAEGER LIDPLATTE.....	371	KILLIAN SEPTUM ELEVATO.....	438, 439
INJECTION CANNULA INJECTION CANNULA.....	36	JAMESON STRABISMUS FORCEPS.....	385	KILLIAN SEPTUM SCISSORS.....	471
INSTRU-CARE INSTRUMENT OIL.....	634	JAMESON STRABISMUS HOOK.....	375	KILLIAN-CLAUS SEPTUM GOUGES.....	442/1
INSTRUMENT BOX.....	617	JANSEN BONE CURETTES.....	257	KILNER NEEDLE HOLDER.....	212
INSTRUMENT OIL INSTRU CARE.....	634	JANSEN BONE RONGEUR.....	237	KILNER NOSE HOOK.....	447/1
INSUFFLATIONCANNULA VERESS.....	206	JANSEN EAR FORCEPS.....	424	KILNER SKIN HOOK.....	608
INTERCHANGEABLE TIPS BARACANI.....	472	JANSEN RETRACTOR.....	168	KILNER SURGICAL SCISSORS.....	54
INTERCHANGEABLE TIPS BRUENINGS.....	472	JAR.....	620	KILNER/RAGNELL SUPERCUT SCISSORS.....	72
INTERCHANGEABLE TIPS CORDES.....	472	JARCHO HOOK FORCEPS.....	583	KILNER-DOUGHTY.....	456
INTERCHANGEABLE TIPS FRAENKEL.....	472	JAVID CAROTIS SHUNT CLAMP.....	511	KIRBY-ARTHUR IRIS FORCEPS.....	385
INTERCHANGEABLE TIPS FRAENKEL.....	472	JENNINGS MOUTH GAGS.....	454	KIRK HAMMER.....	270

KIRSCHNER ABDOMINAL RETRACTOR.....	187, 187/1	LACHRYMAL PROBES BOWMAN	381	LARYNGOSCOPE WARM LIGHT HANDLE WITH	
KIRSCHNER ABDOMINALRETRACTORS	185, 187	LACHRYMAL PROBES HARMS	381	TRANSFORMER CONNECTION	34
KIRSCHNER BONE HAND DRILLS	299	LACRIMAL IRRIGATIONS CANNULA	394	LATERAL VAGINAL RETRACTOR	569
KIRSCHNER DRILLWIRE	306, 307	LAGRANGE SUPER CUT SCISSORS	72	LAWRENCE HEMOSTATIC CLAMP	119
KIRSCHNER GUIDE PROBES	221	LAHEY GRASPING FORCEPS	479	LEAD HAND	250
KIRSCHNER NAIL	308, 309	LAHEY HEMOSTATIC CLAMP	120	LEBSCHÉ CHISEL	267
KIRSCHNER US EXTENSION BOW	312	LAHEY RETRACTOR.....	149, 157	LEES BRONCHUS CLAMP.....	504
KLAPP RETRACTOR.....	150	LAMBERT CHALAZIO TISSUE FORCEPS	393	LEGUE BLADDER RETRACTORS	553
KLEINERT-KUTZ HOHLMEIB	237	LAMBERT-KAY AORTIC-ANASTOMOSIS CLAMP	505	LEGUEU BLADDER SPATULA	552
KLEINERT-KUTZ SKIN HOOK	149	LAMBERT-LOWMAN BONE HOLDING CLAMP	249	LEKSELL(STILLE) BONE RONGEUR	240
KLEINERT-KUTZ TENDON GRASPING INSTRUMENT	294	LAMBOTTE BONE HOLDING FORCEPS.....	244	LELAND-JONES VASCULARSCLAMP	494
KLEINSASSER CHEST SUPPORT.....	36	LAMBOTTE CHISELS	261	LEMPERT BONE CURETTES.....	256
KLEINSASSER FIBERGLAS-LIGHT GUIDE	36	LAMBOTTE RASPATORIES	274, 275	LEMPERT BONE RONGEUR	237
KLEINSASSER INJECTION CANNULA	36	LAMINA SPREADER CLOWARD	339	LEMPERT ELEVATOR.....	420
KLEINSASSER SUCTION TUBE TUBE	36	LAMINA SPREADER INGE.....	339	LERICHÉ GRASPING TISSUE FORCEPS.....	83
KLEINSCHMIDT APPENDIX BOWEL CLAMP	544	LAMINECTOMY RETRACTOR CHERRY	488	LERICHÉ ABDOMINAL SPATULA	143/2
KLINKENBERGH-LOTH VASCULAR SCISSORS	65/1	LAMINECTOMY RETRACTOR FORCEPS CLOWARD	342	LERICHÉ BOWEL SPATULA	143/2
KNAPP CATARACT CURETTE	378	LAMINECTOMY RETRACTOR FORCEPS OLD BERG	341	LERICHÉ HEMOSTATIC CLAMP	111
KNAPP EXTRACTION HOOK.....	375	LAMINECTOMY RETRACTOR FORCEPS SCHLESINGER	342	LESTER FIXATION FORCEPS	389
KNAPP IRIS KNIVES	372	LAMINECTOMY RETRACTOR FORCEPS SPURLING	340	LEVINSON FOREIGN-BODY NEEDLE	374
KNAPP IRIS SCISSORS.....	55	LAMINECTOMY RETRACTOR FORCEPS WAGNER.....	343	LEWIN BONE HOLDING FORCEPS	246
KNAPP-LUER TRACHOMA FORCEPS	393	LAMINECTOMY RETRACTOR FORCEPCSUSHING	340	LEXER BABY DISSECTING SCISSORS	53
KNIGHT SEPTUM FORCEPS.....	425	LAMINECTOMY RETRACTOR FORCEPS FERRIS-SMITH	343	LEXER CHISELS.....	263
KNIVES AMPUTATION	44	LAMINECTOMY RETRACTOR FORCEPS LOVE-GRUENWALD	340	LEXER DISSECTING SCISSORS	53
KNIVES BALLENGER.....	436	LAMINECTOMY RETRACTOR SCOVILLE	196	LEXER MINI GOUGES	263
KNIVES BONE.....	44	LAMINECTOMY RETRACTOR SCOVILLE-HAVERFIELD	196	LEYLA HOLDING ARM SYSTEM	368, 368/1, 368/3, 368/4
KNIVES LANGENBECK.....	47	LANCASTER EYE SPECULA	371	LICHTENBERG NEEDLE HOLDER	213
KNIVES MUCK.....	420	LANCETTE ELECTRODE MONOPOLAR	628, 629	LICHTWITZ CANNULA	433
KNIVES PLESTER	418	LANDAU VAGINAL SPECULA.....	577	LICHTWITZ TROCAR	204
KNIVES ROSEN.....	418	LANDOLT TUMOR GRASPING FORCEPS	341	LIEBERMAN EYE SPECULA	324
KNIVES SCHUKNECHT	418	LANE BENDER	325	LIGATURE RINGS.....	568
KNIVES TABB.....	418	LANE BONE HOLDING FORCEPS	244	LIGATUREE NEEDLE.....	218
KNIVESWULLSTEIN.....	418	LANE BONE LEVERS	290	LIGATUREE NEEDLE COOPER	219
KNOWLES BANDAGE SCISSORS.....	70	LANE BONE LEVERS	290	LIGATUREE NEEDLE DESCHAMPS	218
KOCHER BLADDER SPATULA.....	552	LANE BONE PLATE HOLDING FORCEPS	325	LIGATUREE NEEDLE KRONECKER	219
KOCHER BOWEL CLAMP	540	LANE SCREW DRIVER.....	323, 324	LIGATUREE NEEDLE NELSON	219
KOCHER HEMOSTATIC CLAMP	108	LANE SREW HOLDING FORCEPS	325	LIGATUREE NEEDLE SCHMIEDEN-DICK	219
KOCHER PROBES	479	LANE STOMACH CLAMP	547	LIGHT GUIDE	37
KOCHER RETRACTOR.....	155, 160, 163	LANE SURGICAL TISSUE FORCEPS	84	LIGHT GUIDE COLD LIGHT JACKSON	37
KOCHER-LANGENBECK RETRACTOR	159	LANE TOWEL CLAMP	133	LIGHT GUIDE HOLLINGER	37
KOENIG NEEDLE	223	LANE TRETOWAN BONE LEVERS	290	LIP RETRACTOR.....	453
KOERTE RETRACTOR	162	LANG EXTRACTION DISSECTOR	378	LISTER BANDAGE SCISSORS	69/1
KOGAN ENDOSPECULA	577	LANGE INTERCHANGEABLE TIPS	472	LISTER SUPER CUT SCISSORS	72
KÖNIG BONE LEVERS.....	284	LANGE NOSE HOOK	448	LISTER(SINUS) DRESSING FORCEPS	137
KÖNIG GUIDE PROBES.....	221	LANGE-HOHMANN	286	LISTER-BURCH EYE SPECULA	370
KÖNIG RASPATORIES	276	LANGENBECK NEEDLE HOLDER	213	LISTON AMPUTATION KNIVES	44
KÖNIG RETRACTOR.....	153	LANGENBECK RASPATORIES	275	LISTON BONE CUTTING FORCEPS	241
KOOS DURA KNIVES.....	335	LANGENBECK RETRACTOR	158, 159	LITTAUER CILIA FORCEPS	395
KOPFSCHWARTENFORCEPS GAUSS	605	LANGENBECK GREEN RETRACTOR	153	LITTAUER EAR FORCEPS	411
KRAUSE INTERCHANGEABLE TIPS	472	LARSEN TENDON GRASPING FORCEPS	292	LITTAUER POLYP FORCEPS	425
KRAUSE POLYP SNARE.....	433/2	LARYNGEAL CANNULA WIE	470	LITTAUER SUTURES SCISSORS.....	66
KRAUSE POLYP SNARE	411, 434	LARYNGEAL MIRROR	473	LITTAUER EAR FORCEPS	157
KRAUSE-VOSS POLYP SNARE	433/2	LARYNGEAL MIRROR MICHEL.....	423	LITTLER IRIS SCISSORS	55
KRAYENBÜHL NERVE HOOK.....	336	LARYNGEAL POLYPUS FORCEPS FRAENKEL	471	LITTLEWOOD BOWEL GRASPING FORCEPS	538
KRISTELLER SPECULA	572	LARYNGEAL POLYPUS FORCEPS JURASZ	471	LOCKHART-MUMMERY FISTULA PROBES	200
KRISTELLER VAGINAL SPECULA	572	LARYNGOSCOPE COLD LIGHTHANDLE BATTERY HANDLE	33	LOCKLIN GUM SCISSORS	69
KROENIG TONGUE DEPRESSORS.....	451	LARYNGOSCOPE FOREGGER.....	29, 31	LOCKWOOD-ALLIS BOWEL GRASPING FORCEPS	538
KRONECKER LIGATUREE NEEDLE	219	LARYNGOSCOPE HOLLINGER	37	LONDON-COLLEGE TEETH TISSUE FORCEPS	93
KUGLEN HOOK	376	LARYNGOSCOPE JACKSON	37	LOOP ELECTRODE MONOPOLAR	628, 629
KUHNT CORNEAL SCLEROTOME.....	373	LARYNGOSCOPE MCINTOSH	29, 31	LOPEZ-REINKE TONSIL	465
KÜMMEL ABDOMINAL- A. BOWEL SPATULA.....	143/2, 144	LARYNGOSCOPE MILLER.....	30	LORENZ BANDAGE SCISSORS	70
KÜNTSCHER DRIVER	321	LARYNGOSCOPE WARM LIGHT BATTERY HANDLE	32	LORNA TOWEL CLAMP	133
KÜNTSCHER EXTRACTOR.....	322			LOUTE WIRE INSTRUMENT	315
KÜNTSCHER REAMER.....	321			LOVE NERVE HOOK.....	329, 330
				LOVE RETRACTOR.....	465
L				LOVE-GRUENWALD	340
LA FORCE ADENOID CURETTE.....	450			LOVELACE HEMOSTATIC CLAMP	109
LA FORCE FOREIGN-BODY NEEDLE	374			LOVELACE LUNG GRASPING FORCEPS	490
LA GRANDE GUM SCISSORS	69			LOWER HEMOSTATIC CLAMP	120
LABORDE TRACHEA DILATOR	476			LOWMAN BONE HOLDING CLAMP	249
LACHRYMAL DILAT. WILDER.....	381			LOWMAN-HOGLUND BONE HOLDING CLAMP	249
LACHRYMAL DILAT.CASTROVIEJO	381			LUBET-BARBON NOSE DRESSING FORCEPS	424
LACHRYMAL DILATOR ZIEGLER	381			LUC SEPTUM FORCEPS.....	426

LUCAE EAR FORCEPS.....	410	MC GEE MICRO-EAR FORCEPS.....	414	MIKULICZ PERITONEUMCLAMP.....	123
LUCAE HAMMER.....	271	MCINDOE INEROSSEOUS SCISSORS.....	65/1	MIKULICZ RETRACTOR.....	163
LUCAE HOOK.....	409	MCINDOE TISSUE FORCEPS.....	85	MIKULICZ-BABY PERITONEUMCLAMP.....	123
LUCAE PARACENTESIS NEEDLE.....	408	MCINTOSH LARYNGOSCOP.....	29, 31	MILLER LARYNGOSCOP.....	30
LUCAE TUNING FORC.....	404	MCINTYRE EYE CANNULA.....	394	MILLER NOSE RASP.....	444
LUER BONE RONGEUR.....	236	MCIVOR MOUTH GAGS.....	457	MILLIGAN DURA DISSECTOR.....	332
LUER RETRACTOR.....	140	MCKENY SEPTUM ELEVATOR.....	437, 438	MILLIN BLADDER RETRACTORS.....	552
LUER TRACHEA CANNULA.....	479	MCKENZIE APPLIER FORCEPS.....	326	MILLIN BLADDER SPREADER.....	553
LUER-KOERTE GALL STONE CURETTE.....	533	MCLEAN OBSTETRICAL FORCEPS.....	603	MILLIN CAPSULAR GRASPING FORCEPS.....	551
LUIKART OBSTETRICAL FORCEPS.....	603	MCLEAN-LUIKART OBSTETRICAL FORCEPS.....	603	MILLIN PROSTATIC GRASPING FORCEPS.....	551
LUNDSGAARD SKLEROTOM.....	373	MCLEAN-TUCKER-LUIKART OBSTETRICAL FORCEPS.....	603	MINI BULLDOG CLAMP DEBAKEY-DIETHRICH.....	101
LUNG GRASPING FORCEPS LOVELACE.....	490	MCPHERSON TISSUE FORCEPS.....	392	MINI QUICK HANDLE.....	301
LUNG SCISSORS CRAFOORD.....	65/2	MEAD BONE RONGEUR.....	235	MINI SCALPEL.....	41
LUNG SPATULA ALLISON.....	489	MEAD HAMMER.....	271	MINI SCALPEL HANDLE.....	41
LUNIATSCHKE ELEVATOR.....	465	MEASURANCE CIRCLE CASTROVIEJO.....	380	MINI-BULLDOG CLAMP.....	101
LUPUS CURETTE FOX.....	608	MEASURING INSTRUMENT.....	594	MINI-LAMBOTTE CHISELS.....	262
LUPUS CURETTE PIFFARD.....	608	MEASURING INSTRUMENT.....	594	MINIMUS SPHYGMOMANOMETER.....	11, 12
		MEASURING INSTRUMENT IWANSON.....	624	MINI-TOWNSEND-DOWN BIOPSY FORCEPS.....	591
M		MEASURING RULE.....	25	MINI-TOWNSEND-UP BIOPSY FORCEPS.....	591
MAGILL CATETHER INTRODUCING FORCEPS.....	28	MEDICINE CUP.....	621	MIXTER GALL STONE FORCEPS.....	531
MAIER DRESSING FORCEPS.....	134	MEDICINE SPOON.....	621	MIXTER HEMOSTATIC CLAMP.....	116, 119, 120, 121
MALTZ (COTTLE) NOSE RASP.....	444	MEEKER HEMOSTATIC CLAMP.....	119	MIXTER HEMOSTATIC CLAMP S-CVD.....	116
MALTZ NOSE RASP.....	443	MEHDORN APPLIER FORCEPS.....	362	MIXTER-BABY HEMOSTATIC CLAMP.....	119
MANDIBULAR BODY RETRACTOR HARGIS.....	463/6	MEHDORN VASCULAR CLIP.....	362	MIXTER-O'SHAUGNESSY.....	120
MANDRIN FOR TOURNIQUET.....	528	MELLINGER EYE SPECULA.....	370	MIXTER-O'SHAUGNESSY HEMOSTATIC CLAMP.....	120
MANOMETER.....	295, 596	MELLINGER-AXENFELD EYE SPECULA.....	370	MODELL BONN IRIS TISSUE FORCEPS.....	387
MARKERSONNIN-AMSLER.....	380	MENGHINI BIOPSY NEEDLE.....	206	MOELTGEN GONIOMETER.....	25
MARQUARD BONE RONGEUR.....	239	MENISCUSHOOK BLOUNT.....	289	MOGEN CIRCUMCISION INSTRUMENT.....	556
MARSHIK TONSIL FORCEPS.....	468	MENISCUSKNIVES NEFF.....	292	MOLLISON RETRACTORS.....	171
MARTEL GRASPING FORCEPS.....	110	MENISCUSKNIVES SMILLIE.....	292	MOLT RASPARTORIUM.....	276
MARTIN BONE HOLDING FORCEPS.....	246	MERCEDES THORACIC SPREADER.....	489	MONOPOLAR ELECTRODE BALL.....	628, 629
MARTIN CARTILAGE SCISSORS.....	65/1	MERIAM TEETH TISSUE FORCEPS.....	93	MONOPOLAR ELECTRODE LANCETTE.....	628, 629
MARTIN PELVIMETER.....	605	METAL CATHETER.....	555	MONOPOLAR ELECTRODE LOOP.....	628, 629
MARTIN RETRACTOR.....	175/1	METAL CATHETER COXETER.....	555	MONOPOLAR ELECTRODE NEEDLE.....	628, 629
MARTIN UTERINE-PROBES.....	586	METZENBAUM "S" SURGICAL SCISSORS.....	54	MOOR GALL STONE CURETTE.....	532
MARTINI BONE CURETTES.....	257	METZENBAUM DISSECTING SCISSORS.....	53/1	MOORE BONE HAND DRILLS.....	298
MASSING-NEIVERT NOSE HOOK.....	447/1	METZENBAUM FINO TC DISSECTING SCISSORS.....	53/1	MOORFIELD TISSUE FORCEPS.....	392
MASSON NEEDLE HOLDER.....	210	METZENBAUM NEEDLE HOLDER.....	211	MORGAN PROCTOSCOPE.....	565
MASTIN MUSCLE CLAMP.....	479	METZENBAUM SUPERCUT SCISSORS.....	71	MORITZ-SCHMIDT TONGUE DEPRESSORS.....	452
MATHIEU FOREIGN-BODY FORCEPS.....	553/1	METZENBAUM TC DISSECTING SCISSORS.....	53/1	MORRIS RETRACTOR.....	164
MATHIEU NEEDLE HOLDER.....	213	MEYERDING RETRACTOR.....	157	MORRIS-DEBAKEY AORTIC CLAMP.....	506
MATHIEU RECTAL-SPECULA.....	560	MEYERDING RETRACTORS.....	180	MORSE RIB SPREADER.....	484
MATHIEU RETRACTOR.....	141	MEYHOEFER CHALAZIO CURETTE.....	377	MORSE-FAVALORO RIB SPREADER.....	484
MATHIEU-OLSEN NEEDLE HOLDER.....	212	MICHEL CLIP.....	224	MOUTH GAGS DAVIS-BOYLE.....	455
MATSON RASPARTORIES.....	279	MICHEL CLIP FORCEPS.....	224	MOUTH GAGS DENHART.....	454
MATSON-ALEXANDER RASPARTORIES.....	279	MICHEL CLIP TISSUE FORCEPS.....	224	MOUTH GAGS DINGMANN.....	456
MAXI GRASPER BIOPSY FORCEPS.....	593	MICHEL LARYNGEAL MIRROR.....	423	MOUTH GAGS HEISTER.....	454
MAYFIELD BONE RONGEUR.....	238	MICRO FRIEDMANN.....	234	MOUTH GAGS JENNINGS.....	454
MAYO DISSECTING SCISSORS.....	52	MICRO FRIEDMANN BONE RONGEUR.....	234	MOUTH GAGS MCIVOR.....	457
MAYO GALL STONE CURETTE.....	534	MICRO SICKLE KNIVES.....	475	MOUTH GAGS ROSER-KOENIG.....	454
MAYO GALL STONE PROBES.....	534	MICRO-CURETTE FORCEPS WULLSTEIN.....	416	MOUTH GAGSDOYEN-JANSEN(MOLT).....	454
MAYO STERILIZATION CLAMP.....	227	MICRO-EAR FORCEPS.....	413	MOYNIHAN GALL STONE PROBES.....	532
MAYO SUPERCUT SCISSORS.....	71	MICRO-EAR FORCEPS COS.....	414	MOYNIHAN HEMOSTATIC CLAMP.....	121
MAYO TISSUE FORCEPS.....	89	MICRO-EAR FORCEPS DIETER.....	414	MOYNIHAN TOWEL CLAMP.....	133
MAYO TONGUE DEPRESSORS.....	451	MICRO-EAR FORCEPS GREVEN.....	414	MUCK KNIVES.....	420
MAYO-ADAMS RETRACTORS.....	171	MICRO-EAR FORCEPS HAUGH.....	414	MUELLER EYE SPECULA.....	371
MAYO-BLAKE GALL STONE FORCEPS.....	531	MICRO-EAR FORCEPS JUERS.....	414	MÜLLER APPROXIMATOR.....	364
MAYO-COLLINS RETRACTOR.....	141	MICRO-EAR FORCEPS MCGEE.....	414	MÜLLER VASCULAR CLIP.....	365
MAYO-COLLINS RETRACTOR-SET.....	141	MICRO-EAR SCISSORS BELLUCCI.....	413	MURDOCK EYE SPECULA.....	370
MAYO-HABERISSER WIRE FORCEPS.....	319	MICRO-EAR SCISSORS SHEA.....	413	MURPHY RETRACTOR.....	156
MAYO-HEGAR NEEDLE HOLDER.....	209	MICRO-GRASPING FORCEPSREARSCHAFT.....	415	MURPHY-LANE ELEVATOR.....	283
MAYON-GUYON HEMOSTATIC CLAMP.....	122	MICRO-HARTMANN HEMOSTATIC CLAMP.....	104	MUSCLE CLAMP MASTIN.....	479
MAYO-NOBLE DISSECTING SCISSORS.....	52	MICRO-SCISSORS.....	76, 77, 78, 80	MUSCLE FORCEPS PRINCE.....	387
MAY-OPHTHALMOSKOP UNI.....	14	MICRO-SCISSORS GOMEL.....	80	MUSCLEHOOK.....	267
MAYO-ROBSON BOWEL CLAMP.....	541	MICRO-SCISSORS HEPP-SCHEIDEL.....	78	MUSCLEHOOK GREEN.....	375
MAYO-STILLE DISSECTING SCISSORS.....	52	MICRO-SCISSORS REDA.....	77, 78, 80	MUSCULE FORCEPS BERKE.....	389
MAYO-STILLE SUPERCUT SCISSORS.....	71	MICRO-SCISSORSBELLUCCI.....	417	MUSEUX HOOK FORCEPS.....	583
MC DONALD ELEVATOR.....	283	MICROSURGICAL TISSUE FORCEPS.....	94	MYLES NOSE FORCEPS.....	427
MC GIVNEY HAEMORRHOIDAL LIGATOR.....	568	MICROSURGICAL TISSUE FORCEPS GOMEL.....	96	MYOMA A SCREW DOYEN.....	594
MC IND OE BONE CUTTING FORCEPS.....	241	MICROVASCULAR NEEDLE HOLDER.....	210	MYOMA KNIVES SEGOND.....	594
MC KENZIE DRILL.....	299	MIDDELDORPF RETRACTOR.....	160		
MCCULLOUGH STRABISMUS FORCEPS.....	385	MIDDLETON-JANSEN SEPTUM FORCEPS.....	430		
MCGEE HOOK.....	419	MIKULICZ BOWEL CLAMP.....	543		

N	NEEDLE YOUNG-BOOMERANG.....	220	NOVA SPHYGMOMANOMETER.....	6, 7	
NABATOFF VARICOSE VEIN PROBES.....	201	NEFF MENISCUS KNIVES.....	292	NOVAK BIOPSY CURETTE.....	587
NAEGELE OBSTETRICAL FORCEPS.....	602	NEGUS CHEST SUPPORT.....	459	NOYES EYESSCISSORS.....	75
NAGER RETRACTOR.....	465	NEIVERT NEEDLE HOLDER.....	208	NOYES POLYP FORCEPS.....	425
NAGER TONSIL NEEDLE.....	466	NEIVERT-ANDERSON CHISEL.....	442	NUCLEUS ROTATOR BECHERT.....	379
NAIL BRUSHES.....	611	NELATON PROBES.....	199	NYSTAGMUS SPECTACLES FRENZEL.....	20
NAIL DRILL.....	297	NELSON LIGATUREE NEEDLE.....	219		
NAIL FORCEPS.....	609, 613	NELSON STANDARD TROCAR.....	204	O	
NAIL FORCEPS ANVIL.....	613	NELSON TROCAR.....	205	OBDUKTIONS-BESTECK.....	269
NAIL FORCEPS RADOLF.....	297	NELSON VASCULARTISSUE FORCEPS.....	89	OBSTETRICAL CURETTE SELLHEIM.....	607
NAIL FORCEPS TURNBULL.....	609	NEONATAL VASCULAR CLAMP.....	523	OBSTETRICAL FORCEPS BARTON.....	603
NAIL IMPACTOR.....	322	NEONATAL VASCULAR CLAMP CASTANEDA.....	527	OBSTETRICAL FORCEPS BOERMA.....	604
NAIL NIPPERS.....	612/2, 613, 614	NERVE ENHOOK CUSHING.....	328	OBSTETRICAL FORCEPS DE LEE.....	602
NAIL RASP.....	610	NERVE HOOK CRILE.....	328	OBSTETRICAL FORCEPS ELLIOT.....	602
NAIL SCISSORS.....	609	NERVE HOOK DANDY.....	328	OBSTETRICAL FORCEPS KIELLAND.....	602
NAIL SET.....	609	NERVE HOOK GRAHAM.....	328	OBSTETRICAL FORCEPS KIELLAND-LUIKART.....	603
NAIL SKIN FORCEPS.....	613	NERVE HOOK HOLSHER.....	329	OBSTETRICAL FORCEPS LUIKART.....	603
NAIL SKIN FORCEPS.....	610, 613	NERVE HOOK KRAYENBUEHL.....	336	OBSTETRICAL FORCEPS MCLEAN.....	603
NAIL SPLITTING SCISSORS.....	614	NERVE HOOK LOVE.....	329	OBSTETRICAL FORCEPS MCLEAN-LUIKART.....	603
NAVELSTRINGCLAMP COLLIN.....	605	NERVE HOOK LOVE.....	330	OBSTETRICAL FORCEPS MCLEAN-TUCKER.....	603
NAVELSTRINGCLAMP KANE.....	605	NERVE HOOK SACHS.....	328	OBSTETRICAL FORCEPS MCLEAN-TUCKER-LUIKART.....	603
NEEDLE.....	222, 223	NERVE HOOK SCOVILLE.....	329, 330	OBSTETRICAL FORCEPS NAEGELE.....	602
NEEDLE BARBARA.....	419	NERVE HOOK SMITHWICK.....	328	OBSTETRICAL FORCEPS PIPER.....	604
NEEDLE ELECTRODE MONOPOLAR.....	628, 629	NEUGS TONSIL FORCEPS.....	467	OBSTETRICAL FORCEPS SIMPSON.....	602
NEEDLE GUIDE IOWA.....	206	NEUROSURGICAL SCISSOR STRULLY.....	65	OBSTETRICAL FORCEPS SIMPSON-BRAUN.....	602
NEEDLE HOLDER ADSON.....	211	NEUROSURGICAL SCISSORS.....	65	OBSTETRICAL FORCEPS SIMPSON-LUIKART.....	603
NEEDLE HOLDER ARRUGA.....	214	NEWS TRACHEA HOOK.....	477	OBSTETRICAL FORCEPS WRIGLEY.....	602
NEEDLE HOLDER BABY-OLSEN-HEG.....	212	NIPPERS NAIL.....	612/2, 613, 614	OBWEGESER AHLE.....	463
NEEDLE HOLDER BABY-WEBSTER.....	208	NISSEN FINE HEMOSTATIC CLAMP.....	113	OBWEGESER BLADE OSTEOTOME.....	464/1
NEEDLE HOLDER BARRAQUER.....	217	NISSEN HEMOSTATIC CLAMP.....	113	OBWEGESER RASPARTORIES.....	462
NEEDLE HOLDER BARRAQUER MICRO.....	216	NOISE APPARTUS POLITZER.....	405	OBWEGESER RETRACTOR.....	460, 461
NEEDLE HOLDER BAUMGARTNER.....	208	NORDFOLK-NORWICH RETRACTORS.....	172	OBWEGESER RETRACTORS.....	463
NEEDLE HOLDER BOYNTON.....	214	NORTHBENT SUTURE SCISSORS.....	66	OCHSNER TROCAR.....	205
NEEDLE HOLDER BREZEMANN.....	211	NOSE DRESSING FORCEPS LUBET-BARBON.....	424	O'CONNOR IRIS HOOK.....	375
NEEDLE HOLDER BROWN.....	209	NOSE DRESSING FORCEPS WESTMACOTT.....	424	OEHLER SURGICAL TISSUE FORCEPS.....	81/1
NEEDLE HOLDER CASTROVIEJO.....	215	NOSE FORCEPS CAPLAN.....	428	OLDBERG LAMINECTOMY RETRACTOR FORCEPS.....	347
NEEDLE HOLDER CASTROVIEJO.....	216	NOSE FORCEPS HARTMANN.....	427	OLIVECRONA BONE RONGEUR.....	231
NEEDLE HOLDER CASTROVIEJO MICRO.....	215	NOSE FORCEPS MYLES.....	427	OLIVECRONA BRAINSPATULA.....	336
NEEDLE HOLDER CHEEKSTEEN.....	210	NOSE FORCEPS SCHMEDEN.....	427	OLIVECRONA DURA DISSECTOR.....	332
NEEDLE HOLDER COLLIER 125CM.....	208	NOSE FORCEPS TAKAHASHI.....	427	OLIVECRONA WIRESAW.....	332
NEEDLE HOLDER CRILE.....	213	NOSE FORCEPS WATSON-WILLIAMS.....	428	OLIVECRONA-TOENNIS (SCOVILLE).....	326
NEEDLE HOLDER CRILE-MURRAY.....	209	NOSE FORCEPS WEIL-BLAKESLEY.....	426	OLIVECRONA-TOENNIS APPLIERFORCEPS.....	326
NEEDLE HOLDER CRILE-WOOD TC.....	209	NOSE FORCEPSSTRUYCKEN.....	427	OLLIER RETRACTOR.....	162
NEEDLE HOLDER DE BAKEY.....	210	NOSE HOOK AUFRICHT.....	447	OLSEN-HEGAR NEEDLE HOLDER.....	212
NEEDLE HOLDER DERF.....	208	NOSE HOOK CONVERSE.....	448	OMBREDANNE HAMMER.....	273
NEEDLE HOLDER FINOCCHIETTO.....	211	NOSE HOOK COTTLE.....	447, 447/1	OPHTALMOSKOP MAY UNI II.....	14
NEEDLE HOLDER GILLIES.....	212	NOSE HOOK HOOK.....	447	OP-LARYNGOSKOP HOLINGER.....	37
NEEDLE HOLDER HALSEY.....	208	NOSE HOOK LANGE.....	448	OP-LARYNGOSKOP JACKSON.....	37
NEEDLE HOLDER HALSEY.....	208	NOSE HOOK MASING-NEIVERT.....	447	OP-LARYNGOSKOP KLEINSASSER.....	35
NEEDLE HOLDER HEANEY.....	210	NOSE RASP FOMON.....	444, 445	OPHTHALMOLOGIC SCISSORS.....	57, 58
NEEDLE HOLDER HOESSEL.....	213	NOSE RASP JOSEPH.....	443	OPHTHALMOLOGIC SCISSORS AEBLI.....	58
NEEDLE HOLDER JACOBSON.....	215	NOSE RASP JOSEPH (LEWIS).....	443	OPHTHALMOLOGIC SCISSORS GRADLE.....	57
NEEDLE HOLDER JOHNSON.....	211	NOSE RASP MALTZ.....	443	OPHTHALMOLOGIC SCISSORSSTEVENS.....	58
NEEDLE HOLDER KALT-ARRUGA.....	214	NOSE RASP MALTZ (COTTLE).....	444	OSCILLATION PLASTER CAST SAW.....	230
NEEDLE HOLDER KILNER.....	212	NOSE RASP MILLER.....	444	OSTEOTOME BLADE OBWEGESER.....	464/1
NEEDLE HOLDER LANGENBECK.....	213	NOSE RASP PEET.....	446	OSTEOTOME EPKER.....	464/2
NEEDLE HOLDER LICHTENBERG.....	213	NOSE RASP WIENER.....	443	OSTROEM ANTRUM-PUNCH.....	430
NEEDLE HOLDER MASSON.....	210	NOSE SCISSORS.....	429	O'SULLIVAN-O'CONNOR ABDOMINALDECKEN.....	181
NEEDLE HOLDER MATHIEU.....	213	NOSE SCISSORS COTTLE.....	59	O'SULLIVAN-O'CONNOR ABDOMINALRETRACTORS.....	181
NEEDLE HOLDER MATHIEU-OLSEN.....	212	NOSE SCISSORS FOMON.....	58	O'SULLIVAN-O'CONNOR SP.....	576
NEEDLE HOLDER MAYO-HEGAR.....	209	NOSE SCISSORS HEYMANN.....	58	OTIS URETHROTOME.....	553
NEEDLE HOLDER METZENBAUM.....	211	NOSE SPECULA COTTLE.....	423	OTOSKOPE DIAGNOSTIC SET UNI I.....	13
NEEDLE HOLDER MICROVASCULAR.....	210	NOSE SPECULA HARTMANN.....	422	OVERHOLT HEMOSTATIC CLAMP.....	114
NEEDLE HOLDER NEIVERT.....	208	NOSE SPECULA HARTMANN-HALLE.....	421	OVERHOLT-BABY HEMOSTATIC CLAMP.....	114
NEEDLE HOLDER OLSEN-HEGAR.....	212	NOSE SPECULA KILLIAN.....	423	OVERHOLT-GEISENDOERFER HEMOSTATIC CLAMP.....	114
NEEDLE HOLDER RYDER.....	210	NOSE SPECULA REDA.....	423	OVERHOLT-MIXTER HEMOSTATIC CLAMP.....	115
NEEDLE HOLDER SAROT.....	211	NOSE SPECULA THUDICHUM.....	421	OVUM CURETTE CUZZI.....	606
NEEDLE HOLDER STEVENS.....	214	NOSE SPECULA TIECK-HALLE.....	423	OVUM CURETTE PESTALOZZA.....	606
NEEDLE HOLDER STRATTE.....	212	NOSE SPECULA TYPE VIENNA.....	421	OVUM CURETTE WALLICH.....	607
NEEDLE HOLDER WEBSTER.....	208	NOSE SPECULA VOLTOLINI.....	421	OVUM FORCEPS SAENGER.....	606
NEEDLE REVERDIN.....	220	NOSEOLIVE POLITZER.....	406	OVUM FORCEPS WINTER.....	606
NEEDLE ROSEN.....	419	NOSESAW JOSEPH.....	446		
NEEDLE STERILIZATION CASE.....	615	NOTO UTERINE POLYP FORCEPS.....	585		

P			
PAN BED	621	PLASTER RETRACTOR HENNIG	232
PAN PLACENTA	621	PLASTER RETRACTOR REDA	232
PARACENTESIS NEEDLE LUCAE	408	PLASTER VACUUM WITH OSCILLATING PLASTER SAW	231
PARACENTESIS NEEDLE POLITZER	408	PLASTERSCISSORSSTILLE	229
PARAMETRIUM SCISSORS	63	PLASTIK-HAMMER	271
PARK EYE SPECULA	371	PLATTE JAEGER	371
PARKER RETRACTOR	139	PLEKMANN DRESSING FORCEPS	137
PARTSCH CHISELS	259	PLESTER KNIVES	418
PARTSCH HAMMER	271	PLESTER RETRACTORS	171
PASSOW CHISELS	260	PLESTER SUCTION TUBE	338
PATELLA FORCEPS	248	PNEUMATIC TOURNIQUE	295
PATON CORNEAL DISSECTOR	373	POLITZER AIR BLOWER	406
PAUFIQUE KERATOPLAST-KNIVES	373	POLITZER EAR KNIVES	408
PAUFIQUE TISSUE FORCEPS	392	POLITZER EAR SPECULA	399
PAYR BOWEL CLAMP	548	POLITZER NOSEOLIVE	406
PAYR GUIDE PROBES	221	POLITZER PARACENTESIS NEEDLE	408
PEAN HEMOSTATIC CLAMP	108	POLYP FORCEPS HARTMANN	424
PEAN HEMOSTATIC CLAMP	110	POLYP FORCEPS LITTAUER	425
PEAN HEMOSTATIC CLAMP	108, 110	POLYP FORCEPS NOYES	425
PECK-JOSEPH DISSECTINGSCISSORS	74	POLYP LOOP	411
PEDERSON VAGINAL SPECULA	570	POLYP SNARE KRAUSE	433/2
PEENFIELD DISSECTOR	333	POLYP SNARE KRAUSE	411, 434
PEERS TOWEL CLAMP	132	POLYP SNARE KRAUSE-VOSS	433/2
PEET NOSE RASP	446	POLYP SNARE WILDE	433/2
PEET SPLINTER FORCEPS	92	POLYP SNARE WILDE	411, 434
PELVIMETER COLLIER	605	POOLE SUCTION TUBE	27
PELVIMETER MARTIN	605	POST MORTEM	268
PELVIS-HOOK ST.MARKS	165	POST MORTEM KNIVES	48
PENISCLAMP STOCKMANN	553/1	POST MORTEM KNIVES VIRCHOW	48
PENISCLAMP STRAUSS	553/1	POTTS SMITH SURGICAL TISSUE FORCEPS	81
PENNINGTON HEMOSTATIC CLAMP	109	POTTS-DE MARTEL VASCULARSCISSORS	59
PENNINGTON SEPTUM ELEVATOR	438	POTTS-SMITH ANATOMIC TISSUE FORCEPS	81
PERCUSSION HAMMER BABINSKY	24	POTTS-SMITH VASCULAR SCISSORS	61
PERCUSSION HAMMER BERLINER	24	PRATT FISTULA PROBES	563
PERCUSSION HAMMER BUCK	24	PRATT GRASPING FORCEPS	110
PERCUSSION HAMMER TAYLOR	24	PRATT HOOK FORCEPS	584
PERCUSSION HAMMER TROEMNER	24	PRATT RECTAL-SPECULA	559
PERCY REKTRAKTOR	296	PRATT UTERINE DILATATOR	580
PERFORATORS SMELLIE	607	PRECISA SPHYGMOMANOMETER	9
PERIPHERAL-VASCULAR CLAMP DE BAKEY	494	PRICE-THOMAS BRONCHUS CLAMP	490
PERIPHERAL-VASCULAR CLAMP LELAND-JONES	494	PRINCE MUSCLE FORCEPS	387
PERITONEUMCLAMP FAURE	123	PRINCE TONSIL SCISSORS	59
PERITONEUMCLAMP MIKULICZ	123	PROBE AND PACKER	612
PERITONEUMCLAMP MIKULICZ-BABY	123	PROBE TIPS	201
PERITONEUMCLAMP PHANEUF	123	PROBES BRODIE	199
PERKINS RETRACTORS	168	PROBES DOYEN	199
PERTHES AWL	304	PROBES FISH	199
PESTALOZZA OVUM CURETTE	606	PROBES HARMS	333
PETRI BOX	620	PROBES KOCHER	479
PETZ STOMACH AND BOWEL SUTUREING APPARATUS	549	PROBES NELATON	199
PHALANGEN KNIVES	44	PROBES VALLEIX	586
PHANEUF PERITONEUM CLAMP	123	PROBES WATSON-CHEYNE	199
PIERCE SEPTUM	438	PROBES WORST	333
PIERCE TROCER	204	PROCTOSCOPE BENSAUDE	565
PIFFARD LUPUS CURETTE	608	PROCTOSCOPE CHELSEA-EATON	563
PILLING CLIP FORCEPS	524	PROCTOSCOPE FANSLER	564
PIN CUTTER	320	PROCTOSCOPE KELLY	562, 563
PINARD STETHOSCOPE	23	PROCTOSCOPE MORGAN	565
PINWHEEL WARTENBERG	25	PROSTATIC GRASPING FORCEPS MILLIN	551
PIPER OBSTETRICAL FORCEPS	604	PROSTATIC HOOK YOUNG	550
PISTOL FOR CLEANING	626	PROVIDENCE-HOSPITAL HEMOSTATIC CLAMP	106
PLACENTA PAN	621	PUNCH KEYES	608
PLASTER CAST SAW ELEKTRISCH	230	PUNCTION CANNULA FRAZIER	337
PLASTER CAST SAW ENGEL	229	PUNCTION CANNULA LICHTWITZ	433
PLASTER FORCEPS WOLFF	233	PUNCTION CANNULA QUINKE	206
PLASTER KNIVES ESMARCH	233	PUTTI BONE RASP	294
PLASTER KNIVES HOPKINS	233	PYLORUSRETRACTOR BENSON	544
PLASTER KNIVES REINER	233		
PLASTER KNIVES WIGMORE	229		
PLASTER RETRACTOR BEESON	232		
PLASTER RETRACTOR HAGLUND-STILLE	232		
		Q	
		QUERVAIN ELEVATOR	275
		QUICK HANDLE	301
		QUINBY GUM SCISSORS	67
		QUINKE PUNCTION CANNULA	206
		QUIRE FOREIGN-BODY LEVER	412
		QUISLING HAMMER	271
		R	
		RACHIOTOM	267
		RADOLF NAIL FORCEPS	297
		RALK BONE HAND DRILLS	300
		RAMPLEY DRESSING FORCEPS	136
		RAMUS RETRACTOR	461
		RANDALL BIOPSY CURETTE	587
		RANDALL KIDNEY STONE FORCEPS	535
		RANEY APPLING FORCEPS	327
		RANGELL RETRACTOR	140
		RASPTORIES	279
		RASPTORIES ADSON	282
		RASPTORIES ALEXANDER	276
		RASPTORIES COBB	280
		RASPTORIES DINGMANN	463, 463/3
		RASPTORIES DOYEN	278
		RASPTORIES FARABEUF	274
		RASPTORIES FARABEUF-COLLIN	274
		RASPTORIES FOMON	277
		RASPTORIES JOSEPH	277
		RASPTORIES KOENIG	276
		RASPTORIES LAMBOTTE	274
		RASPTORIES LANGENBECK	275
		RASPTORIES MATSON	279
		RASPTORIES MATSON-ALEXANDER	279
		RASPTORIES OBWEGESER	462
		RASPTORIES SEMB	278
		RASPTORIES WILLIGER	276
		RASPTORIESIUM MOLT	276
		RASPTORIESIUM WIBERG	277
		RASPTORIESSEDILLOT	274, 275
		RASPTORY HARGIS	463/2
		RASPTORY SELDING	277
		RAZOR BLADES	45
		REAMER KUENTSCHER	321
		RECAMIER UTERINE CURETTE	597
		RECTAL BIOPSY FORCEPS TURREL	567
		RECTAL SUCTION TUBE BUJE	566
		RECTALBIOPSY FORCEPS YEOMAN	566, 567
		RECTALSNARE WESTON	566
		RECTAL-SPECULA ALAN-PARKS	561
		RECTAL-SPECULA BARR	559
		RECTAL-SPECULA BODENHAMMER	559
		RECTAL-SPECULA CZERNY	559
		RECTAL-SPECULA HILL-FERGUSON	560
		RECTAL-SPECULA MATHIEU	560
		RECTAL-SPECULA PRATT	559
		RECTAL-SPECULA SAWYER	560
		RECTAL-SPECULA SCHULZE-BERG	560
		RECTAL-SPECULA SIMS	559
		RECTUM-ANAST.KL. HAYES	545
		REDA TUNING FORC	403
		REDA AMPUTATION KNIVES	44
		REDA BLADEBREAKER	45
		REDA BONE CURETTES	256
		REDA BONE HAND DRILLS	300
		REDA BONE HOLDING FORCEPS	246, 247
		REDA BOWEL GRASPING FORCEPS ATRAUMA	111
		REDA CILIA FORCEPS	395
		REDA COTTON-APPLICATOR	203
		REDA EXCENTER BANDAGE SCISSORS	69/2
		REDA EYE MAGNET	395
		REDA FINGER RING SAW	297
		REDA NOSE SPECULA	423
		REDA PLASTER RETRACTOR	232

REDA SICKLE KNIVES.....	435	RETRACTOR MORRIS.....	164	RIB SPREADER HAIGHT.....	487
REDA SKIN HOOK.....	150	RETRACTOR MURPHY.....	156	RIB SPREADER MORSE.....	484
REDA STERILIZATION FORCEPS.....	615	RETRACTOR NAGER.....	465	RIB SPREADER MORSE-FAVALORO.....	484
REDA SUTURE FORC.....	221	RETRACTOR OBWEGESER.....	460, 461	RIB SPREADER RIENHOFF-FINOCHIETTO.....	486
REDON GUIDE NEEDLE.....	207	RETRACTOR OLLIER.....	162	RIB SPREADER TUFFIER.....	487
REES FACE LIFT SCISSORS.....	73	RETRACTOR PARKER.....	139	RIB SPREADERBAILEY-GIBBON.....	489
REICHERT DECKEL EPIGLOTTIS RETRACTOR.....	471	RETRACTOR RAGNELL.....	140	RIBBON BOWEL SPATULA.....	143
REILL BONE HOLDING FORCEPS.....	248	RETRACTOR RAMUS.....	461	RICARD ABDOMINALRETRACTORS.....	191
REINER EAR SYRINGE.....	406	RETRACTOR RICHARDSON.....	142	RICHARDSON RETRACTOR.....	142
REINER PLASTER KNIVES.....	233	RETRACTOR RICHARDSON GRIP.....	142	RICHARDSON-EASTMAN RETRACTOR.....	142
REKORDSYRINGE.....	596	RETRACTOR RICHARDSON-EASTMAN.....	142	RICHARDSON-GRIP RETRACTOR.....	142
RESANO BOWEL CLAMP.....	542	RETRACTOR ROSE.....	140	RICHNAU-HOLMGREN EAR SPECULA.....	400
RESANO CAPSULA SCISSORS.....	53/2	RETRACTOR ROUX.....	139	RICHTER-HEATH CLIP FORCEPS.....	224
RESECTION KNIVES.....	47	RETRACTOR ROUX-BABY.....	140	RIENHOFF-FINOCHIETTO RIB SPREADER.....	486
RETRACTOR ALM.....	168	RETRACTOR ROUX-MINI.....	140	RIGBY ABDOMINALRETRACTORS.....	189/2
RETRACTOR ANDERSON.....	198	RETRACTOR SAUERBRUCH.....	164	RI-MINI DIAGNOSTIC SET.....	17
RETRACTOR ASSEMBLY.....	188	RETRACTOR SAUERBRUCH.....	164, 166	RING OVAL.....	194
RETRACTOR AUFFRANC.....	289	RETRACTOR SENN-GREEN.....	153	RING ROUND.....	194
RETRACTOR BREAST.....	198	RETRACTOR SENN-MILLER.....	143	RING SEGMENT.....	194
RETRACTOR BRUNNER.....	167	RETRACTOR SIMON.....	164	RING TONGUE DEPRESSORS.....	455
RETRACTOR COLLIN.....	139	RETRACTOR SPINA-NASALIS.....	461	RINGS LIGATURE.....	568
RETRACTOR COLLIN HARTMANN.....	141	RETRACTOR TEBBETTS.....	197	RITTER-HALLE IRRIGATION CANNULA.....	433
RETRACTOR COOLEY.....	148	RETRACTOR TESSIER.....	463/3	ROBB SPATULA.....	530
RETRACTOR CORONAL BROW.....	198	RETRACTOR TUFFIER.....	147	ROBERTS HEMOSTATIC CLAMP.....	117
RETRACTOR CORYLLOS.....	166	RETRACTOR US-ARMY PARKER-LANG.....	141	ROCHARD ABDOMINAL RETRACTORS.....	186
RETRACTOR CRILE.....	140	RETRACTOR VOLKMANN.....	153	ROCHESTER-CARMALT HEMOSTATIC CLAMP.....	109
RETRACTOR CUSHING.....	151	RETRACTOR VOLKMANN.....	156	ROCHESTER-OCHSNER HEMOSTATIC CLAMP.....	108
RETRACTOR DAVIDSON (SCAPULA).....	166	RETRACTOR YANCOSKIE.....	198	ROCHESTER-PEAN HEMOSTATIC CLAMP.....	108
RETRACTOR DEAVER.....	145	RETRACTOR ZENKER.....	161	ROEDER TOWEL CLAMP.....	132
RETRACTOR DEAVER GRIP.....	146	RETRACTORS ADSON.....	173	ROGER SEPTUM.....	437
RETRACTOR DEBAKEY.....	189/1	RETRACTORS ADSON.....	172, 173, 174	ROGERS HYSTERECTOMYCLAMP.....	127
RETRACTOR DELEE.....	574	RETRACTORS ANDERSON-ADSON.....	172	ROGGE STERILIZATION FORCEPS.....	227
RETRACTOR DESMARRS.....	151	RETRACTORS BECKMANN.....	176	ROLLET EXTIRPATION CHISELS.....	374
RETRACTOR DESMARRS.....	151	RETRACTORS BECKMANN-ADSON.....	175	ROLLET EXTRACTION HOOK.....	375
RETRACTOR DOYEN.....	163	RETRACTORS BECKMANN-EATON.....	176	RONGEUR CITELLI.....	430
RETRACTOR DOYEN-STILLE.....	167	RETRACTORS CASPAR.....	179, 180	RONGEUR FERRIS-SMITH-KERRISON.....	344, 344/2
RETRACTOR FARABEUF.....	139	RETRACTORS CLOWARD.....	178	RONGEUR HAJEK-KOFLER.....	429, 431
RETRACTOR FERRIERA.....	197	RETRACTORS DARLING.....	178	RONGEUR HOLTH.....	380
RETRACTOR FINSEN.....	168	RETRACTORS HENLEY.....	170	RONGEUR KERRISON.....	428
RETRACTOR FREEMAN.....	198	RETRACTORS MAYO-ADAMS.....	171	ROSE RETRACTOR.....	140
RETRACTOR FRITSCH.....	163	RETRACTORS MEYERDING.....	180	ROSEN KNIVES.....	418
RETRACTOR GIL-VERNET.....	152	RETRACTORS MOLLISON.....	171	ROSEN NEEDLE.....	419
RETRACTOR GOELET.....	141	RETRACTORS NORDFOLK-NORDWICH.....	172	ROSEN SUCTION TUBE.....	338
RETRACTOR GREEN.....	160	RETRACTORS PERKINS.....	168	ROSER-KOENIG.....	454
RETRACTOR HARRINGTON.....	147	RETRACTORS PLESTER.....	171	ROUND RING MEDIUM.....	194
RETRACTOR HARRINGTON-PEMBERTON.....	147	RETRACTORS PLESTER.....	171	ROUX MINI RETRACTOR.....	140
RETRACTOR HEANEY.....	164	RETRACTORS PLESTER.....	171	ROUX RETRACTOR.....	139
RETRACTOR HIBBS.....	164	RETRACTORS SCALP-CONTOUR.....	169	ROUX-BABY RETRACTOR.....	140
RETRACTOR HOESSEL.....	167	RETRACTORS TRAVERS.....	172	ROWE.....	459
RETRACTOR HOFER.....	465	RETRACTORS WEITLANER.....	169	RUBIN SEPTUM FORCEPS.....	428
RETRACTOR HOLZHEIMER.....	168	RETRACTORS WULLSTEIN.....	171	RUDD HAEMORRHOIDAL LIGATOR.....	568
RETRACTOR ISRAEL.....	162	RETRAKTOR PERCY.....	296	RUMEL HEMOSTATIC CLAMP.....	117
RETRACTOR JACKSON-BURROWS RETRACTOR.....	189/2	REVERDIN BOWEL SPATULA.....	143/1	RUMEL-BELMONT TOURNIQUET.....	528
RETRACTOR JANSEN.....	168	REVERDIN NEEDLE.....	220	RUSKIN BONE RONGEUR.....	239
RETRACTOR KELLY.....	164	REYNOLDS SUPERCUT SCISSORS.....	72	RUSKIN-LISTON BONE CUTTING FORCEPS.....	241
RETRACTOR KELLY GRIP.....	142	REYNOLDS SURGICAL SCISSORS.....	54	RUSS MODELL GRASPING TISSUE FORCEPS.....	85
RETRACTOR KLAPP.....	150	RHINOPLASTIKSCISSORS FOMON.....	65/1	RUSSEL-DAVIS.....	458
RETRACTOR KOCHER.....	155	RIB SCISSORS.....	480	RYDEL-SEIFFERT TUNING FORC.....	404
RETRACTOR KOCHER.....	160, 163	RIB SCISSORS BETHUNE.....	481	RYDER NEEDLE HOLDER.....	210
RETRACTOR KOCHER-LANGENBECK.....	159	RIB SCISSORS BRUNNER.....	481		
RETRACTOR KOERTE.....	162	RIB SCISSORS CORYLLOS.....	480	S	
RETRACTOR KÖNIG.....	153	RIB SCISSORS GIERTZ-STILLE.....	481	SAALFELD COMEDONE EXTRACTOR.....	608
RETRACTOR LAHEY.....	157	RIB SCISSORS GLUCK.....	480	SACHS DURA DISSECTOR.....	332
RETRACTOR LANGENBECK.....	158, 159	RIB SCISSORS SAUERBRUCH.....	481	SACHS NERVE HOOK.....	328
RETRACTOR LANGENBECK-GREEN.....	153	RIB SCISSORS SAUERBRUCH-FREY.....	481	SAENGER OVUM FORCEPS.....	606
RETRACTOR LITTLE.....	157	RIB SCISSORSSTILLE.....	480	SAGITTAL SPLIT RETRACTOR SMITH.....	463/5
RETRACTOR LOVE.....	465	RIB SPREADER BAILEY.....	489	SALPINGOGRAPHSCHULTZE.....	596
RETRACTOR MARTIN.....	175/1	RIB SPREADER BAILEY-BABY.....	489	SANVENERO SURGICAL SCISSORS.....	54
RETRACTOR MATHIEU.....	141	RIB SPREADER COOLEY.....	487	SAROT HEMOSTATIC CLAMP.....	118
RETRACTOR MEYERDING.....	157, 177	RIB SPREADER COOLEY-NEONATAL.....	485	SAROT NEEDLE HOLDER.....	211
RETRACTOR MEYERDING.....	177	RIB SPREADER DE BOER.....	486	SATINSKY TANGENTIALCLAMP.....	502
RETRACTOR MIDDELDORPF.....	160	RIB SPREADER FINOCHIETTO.....	482, 484	SATINSKY VASCULARSCISSORS.....	65/1
RETRACTOR MIKULICZ.....	163	RIB SPREADER FINOCHIETTO-BURFORD.....	483	SATINSKY VASCULARSCLAMP.....	491

SATO CORNEAL SCARIFIER.....	373	SCOVILLE NERVE HOOK.....	329, 330	SIEBENMANN IRRIGATION CANNULA.....	433/1
SATTERLEE AMPUTATION SAW.....	296	SCOVILLE-HAVERFIELD LAMINECTOMY		SIEBOLD GYNECOLOGICAL SCISSORS.....	62
SAUERBRUCH BONE RONGEUR.....	240	RETRACTORRETRACTOR.....	196	SIEGLE EAR SPECULA.....	402
SAUERBRUCH RETRACTOR.....	164	SCREW DRIVER.....	232	SILICONMATT.....	616
SAUERBRUCH RETRACTOR.....	164, 166	SCREW DRIVER LANE.....	323	SILVER DERMATOM.....	50
SAUERBRUCH RIB SCISSORS.....	481	SCREW DRIVER WILLIAMS.....	323	SILVER SEPTUM CHISELS.....	442
SAUERBRUCH WASTEFORCEPS.....	227	SCREW HOLDING SLEEVE.....	324	SILVERCLAMP.....	326
SAUERBRUCH-FREY STERNUM SCISSORS.....	481	SCUDDER BOWEL CLAMP.....	541	SIMCOE IRRIGATION CANNULA.....	394/2
SAW BLADES FOR AUTOPSY SAW.....	231/2	SEBLEAU ELEVATOR.....	275	SIMON RETRACTOR.....	164
SAW GIGLI.....	332	SECTION NEEDLE.....	268	SIMON UTERINE CURETTE.....	594
SAWTELL TONSIL FORCEPS.....	467	SEDILLOT RASPARTORIES.....	274	SIMPLEX TUBING CLAMP.....	624
SAWYER RECTAL SPECULA.....	560	SEGMENTED RING.....	194	SIMPSON OBSTETRICAL FORCEPS.....	602
SAYRE ELEVATOR.....	281	SEGOND HYSTERECTOMYCLAMP.....	125	SIMPSON-BRAUN OBSTETRICAL FORCEPS.....	602
SCAGLIETTI BONE RONGEUR.....	240	SEGOND MYOMA KNIVES.....	594	SIMPSON-LUIKART OBSTETRICAL FORCEPS.....	603
SCALP-CONTOUR RETRACTORS.....	169	SEGOND-LANDAU HYSTERECTOMYCLAMP.....	125	SIMS GYNECOLOGICAL SCISSORS.....	62
SCALPEL.....	46	SEIFERT INTERCHANGEABLE TIPS.....	472	SIMS RECTAL-SPECULA.....	559
SCALPEL MINI.....	41	SELDIN RASPARTORY.....	277	SIMS UTERINE CURETTE.....	597
SCALPEL STERILE.....	43	SELLHEIM OBSTETRICAL CURETTE.....	607	SIMS UTERINE DILATOR.....	581
SCALPEL-BLADE.....	42	SEMB BONE CUTTING FORCEPS.....	242	SIMS UTERINE-DEPRESSOR.....	586
SCALPELBLADE REMOVER.....	42	SEMB BONE HOLDING FORCEPS.....	243	SIMS UTERINE-PROBES.....	586
SCALPEL-HANDLE.....	38, 39, 39/1, 39/2, 40, 42	SEMB BONE RONGEUR.....	240	SIMS VAGINAL SPECULA.....	573
SCALPEL-HANDLE COLLIN.....	40	SEMB BRONCHUSCLAMP.....	491	SIMS-MAIER DRESSINGFORCEPS.....	134
SCALPELHANDLE MINI.....	41	SEMB RASPARTORIES.....	278	SINGLEY TISSUE FORCEPS.....	88
SCHAEDEL TOWEL CLAMP.....	132	SEMKEN ANATOMIC TISSUE FORCEPS.....	86	SINSKEY HOOK.....	376
SCHAMBERG COMEDONE EXTRACTOR.....	608	SEMKEN SURGICAL TISSUE FORCEPS.....	86	SINUS SEPTUM ELEVATOR.....	438
SCHUDE BONE CURETTES.....	251	SEMM VAGINAL SPECULA.....	571	SINUSCOPY FORCEPS.....	431
SCHIEE GONIOTOMY KNIVES.....	373	SENN-GREEN RETRACTOR.....	153	SINUSCOPY-TROCAR.....	205
SCHIEINMANN INTERCHANGEABLE TIPS.....	472	SENN-MILLER RETRACTOR.....	143	SINUS-PROBES.....	438
SCHERBAK VAGINAL SPECULA.....	575	SEPTUM CANNULA.....	406	SISIMPACTION FORCEPS ROWE.....	459
SCHINK DERMATOME.....	49	SEPTUM CHISELS CINELLI.....	441	SKENE HOOK FORCEPS.....	582
SCHIOETZ TONOMETER.....	394/2	SEPTUM CHISELS COTTLE.....	440	SKIN HOOK COTTLE.....	447, 448
SCHLESINGER LAMINECTOMY RETRACTOR FORCEPS		SEPTUM CHISELS FOMON.....	441	SKIN HOOK COTTLE-NEVERT.....	448
.....	342	SEPTUM CHISELS FREER.....	439	SKIN HOOK FOMON.....	447/1
SCHMEDEN NOSE FORCEPS.....	427	SEPTUM CHISELS SHEEHAN.....	441	SKIN HOOK FRAZIER.....	149
SCHMID VASCULAR-IRRIGATION CANNULA.....	338	SEPTUM CHISELS SILVER.....	442	SKIN HOOK FREER.....	448
SCHMIEDEN GUIDEPROBES.....	221	SEPTUM ELEVATOR BALLENGER.....	439	SKIN HOOK GILLIES.....	448
SCHMIEDEN-DICK LIGATUREE NEEDLE.....	219, 221	SEPTUM ELEVATOR COTTLE.....	439	SKIN HOOK GRAEFE.....	149
SCHMIEDEN-TAYLOR DURASCISSORS.....	65/1	SEPTUM ELEVATOR COTTLE-JOSEPH.....	439	SKIN HOOK GUTHRIE.....	149
SCHNIDT TONSIL FORCEPS.....	467	SEPTUM ELEVATOR FREER.....	437	SKIN HOOK JOSEPH.....	149
SCHOENBORN THYROID GLAND HOOK.....	479	SEPTUM ELEVATOR HAJEK-BALLENGER.....	439	SKIN HOOK KILNER.....	608
SCHRÖDER HOOK FORCEPS.....	583, 584	SEPTUM ELEVATOR HALLE.....	437	SKIN HOOK KLEINERT-KUTZ.....	149
SCHRÖDER UTERINE CURETTE.....	595	SEPTUM ELEVATOR HOWARTH.....	438	SKIN HOOK REDA.....	150
SCHROEDER(POZZI) HOOK FORCEPS.....	582	SEPTUM ELEVATOR JOSEPH.....	437	SKIN SCISSORS.....	610
SCHUBERT BIOPSY FORCEPS.....	588	SEPTUM ELEVATOR KILLIAN.....	438	SKIN STRAIGHTENING BLADE FOR DERMATOME.....	49
SCHUKNECHT KNIVES.....	418	SEPTUM ELEVATOR MCKENTY.....	437, 438	SKIN-PUNCH KEYE.....	608
SCHULTZE SALPINGOGRAPH.....	596	SEPTUM ELEVATOR PENNINGTON.....	438	SKIN-PUNCH KEYE.....	608
SCHULZE-BERGMANN RECTAL-SPECULA.....	560	SEPTUM ELEVATOR PIERCE.....	438	SKLEROTOM GUYTON-LUNDGAARD.....	373
SCHUMACHER BIOPSY FORCEPS.....	588, 589	SEPTUM ELEVATOR ROGER.....	437	SKLEROTOM LUNDGAARD.....	373
SCHUMACHER EPISOTOMY SCISSORS.....	64	SEPTUM FORCEPS BRUENINGS.....	425	SLS CLIP FORCEPS.....	524
SCHUMACHER INTERCHANGEABLE TIPS.....	472	SEPTUM FORCEPS HEYMANN.....	425	SLUDER-BALLENGER.....	470
SCHUMACHER STERNUM SCISSORS.....	481	SEPTUM FORCEPS KNIGHT.....	425	SMELLIE HOOK.....	605
SCHWEIGGER CAPSULAR FORCEPS.....	391	SEPTUM FORCEPS LUC.....	426	SMELLIE PERFORATORS.....	607
SCISSORS CASTROVIEJO.....	79	SEPTUM FORCEPS MIDDLETON-JANSEN.....	430	SMILLIE BONE LEVERS.....	291
SCISSORS COTTLE.....	56	SEPTUM FORCEPS RUBIN.....	428	SMILLIE MENISCUSKNIVES.....	292
SCISSORS DOYEN.....	63	SEPTUM GOUGES FREER.....	442/1	SMITH EYE SPECULA.....	370
SCISSORS ENTEROTOMY.....	66	SEPTUM GOUGES HAJEK.....	442/1	SMITH SAGITTAL SPLIT RETRACTOR.....	463/5
SCISSORS ENUCLEATION.....	58	SEPTUM GOUGES KILLIAN-CLAUS.....	442/1	SMITH US ARMY BANDAGE SCISSORS.....	69/1
SCISSORS GORNEY.....	73	SEPTUM KNIVES CONVERSE.....	435	SMITH-BUIE ANAL RETRACTOR.....	561
SCISSORS GRAEFE.....	56	SEPTUM KNIVES COTTLE.....	435	SMITH-PETERSEN.....	261
SCISSORS HEPP-SCHUIDEL.....	78	SEPTUM KNIVES FREER.....	434	SMITH-PETERSEN BONE RONGEUR.....	238
SCISSORS MARTIN CARTILAGE.....	65/1	SEPTUM KNIVES JOSEPH.....	434, 435	SMITHWICK APPLIERSFORCEPS.....	326
SCISSORS MICRO.....	76	SEPTUM SCISSORS KILLIAN.....	471	SMITHWICK NERVE HOOK.....	328
SCISSORS NEUROSURGICAL.....	65	SEPTUM STRAIGHTENING FORCEPS ASCH.....	449	SNELLEN CATARACT LOOP.....	378
SCISSORS PARAMETRIUM.....	63	SEPTUM STRAIGHTENING FORCEPS WALSHAM.....	449	SNELLEN ENTROPIONUM FORCEPS.....	393
SCISSORS REES.....	73	SERPENTINE BIOPSY FORCEPS.....	593	SOMER UTERINE-GRASPING FORCEPS.....	585
SCISSORS SIEBOLD.....	62	SEUTIN BANDAGE SCISSORS.....	69/2	SPAREBLADE.....	49
SCISSORS SIMS.....	62	SEXTON EAR KNIVES.....	408	SPAREBLADE STERILE.....	50
SCISSORS THOREK.....	65/2	SHAPLEIGH EAR LOOP.....	410	SPATULA.....	203, 612
SCISSORS WAGNER.....	67	SHAVER KNIVES.....	49	SPATULA AND PACKER.....	612
SCISSORS WERTHEIM.....	63	SHEA MICRO-EAR SCISSORS.....	413	SPATULA HIRSCHMAN.....	379
SCOVILLE BONE CURETTE.....	253	SHEEHAN CHISELS.....	441	SPECULA FRIEDMANN.....	577
SCOVILLE HOOK.....	196	SHEETS EYE CANNULA.....	394/2	SPECULA KALLMORGEN.....	573
SCOVILLE LAMINECTOMY RETRACTORRETRACTOR.....	196	SICKLE KNIVES REDA.....	435	SPECULA KRISTELLER.....	572

SPECULA O'SULLIVAN-O'CONNOR.....	576	STILLE RIB SCISSORS.....	480	SURGICAL SCISSORS STANDARD.....	51
SPENCER SUTURE SCISSORS.....	66	STILLE SURGICAL TISSUE FORCEPS.....	81	SURGICAL SCISSORS SYSTRUNK.....	66
SPENCER-WELLS HEMOSTATIC CLAMP.....	109	STILLE-BARRAYA VASCULARTISSUE FORCEPS.....	88	SURGICAL TISSUE FORCEPS.....	81
SPHYGMOMANOMETER BABYPHON.....	10	STILLE-HORSLEY BONE CUTTING FORCEPS.....	242	SURGICAL TISSUE FORCEPS ADSON.....	81/2
SPHYGMOMANOMETER DIPLOMAT.....	5	STILLE-LISTON BONE CUTTING FORCEPS.....	241	SURGICAL TISSUE FORCEPS ADSON MICRO.....	81/2
SPHYGMOMANOMETER EXACTA.....	8	STILLE-LUER BONE RONGEUR.....	239	SURGICAL TISSUE FORCEPS ADSON-BROWN.....	82
SPHYGMOMANOMETER MINIMUS.....	11, 12	STILLE-RUSKIN BONE RONGEUR.....	239	SURGICAL TISSUE FORCEPS BONNEY.....	88
SPHYGMOMANOMETER NOVA.....	6, 7	STILLE-SHERMAN BONE HAND DRILLS.....	298	SURGICAL TISSUE FORCEPS BROPHY.....	84
SPHYGMOMANOMETER PRECISA.....	9	STOCKMANN PENISCLAMP.....	553/1	SURGICAL TISSUE FORCEPS CUSHING.....	83
SPINAL BONE CURETTES.....	253	STOMACH CLAMP LANE.....	547	SURGICAL TISSUE FORCEPS FERRIS-SMITH.....	85
SPINAL HOOK TAYLOR.....	291	STOMACH-/BOWEL SUTUREING APPARTUS V.PETZ.....	549	SURGICAL TISSUE FORCEPS GERALD.....	87
SPINA-NASALIS RETRACTOR.....	461	STOMACH-BOWEL CLAMP MIKULICZ.....	543	SURGICAL TISSUE FORCEPS GILLIES.....	86
SPLINTERFORCEPS ARCHER.....	92	STONE FORCEPS.....	545	SURGICAL TISSUE FORCEPS SEMKEN.....	84
SPLINTERFORCEPS PEET.....	92	STONE HOLDING CLAMP.....	545	SURGICAL TISSUE FORCEPS OEHLER TC.....	81/1
SPLINTERFORCEPS VIRTUS (PALK).....	92	STRABISMUS FORCEPS BONACCOLTO.....	385	SURGICAL TISSUE FORCEPS POTTS SMITH.....	81
SPLINTERFORCEPSSTIEGLITZ.....	92	STRABISMUS FORCEPS DASTOOR.....	386	SURGICAL TISSUE FORCEPS SEMKEN.....	86
SPLINTERTISSUE FORCEPS.....	91	STRABISMUS FORCEPS JAMESON.....	385	SURGICAL TISSUE FORCEPS STILLE.....	81
SPLINTERTISSUE FORCEPS CARMALT.....	91	STRABISMUS FORCEPS MCCULLOUGH.....	385	SURGICAL TISSUE FORCEPS TAYLOR.....	87
SPLINTERTISSUE FORCEPS FEILCHENFELD.....	91	STRABISMUS HOOK GRAEFE.....	375	SURGICAL TISSUE FORCEPS TYPE USA.....	81/1
SPLINTERTISSUE FORCEPS HUNTER.....	91	STRABISMUS HOOK JAMESON.....	375	SURGICAL TISSUE FORCEPS WAUGH.....	83
SPOON MEDICINE.....	621	STRANDELL-STILLE RETRACTOR.....	157	SUTUREFORC REDA.....	221
SPRATT BONE CURETTES.....	251	STRASSBURGER TISSUE FORCEPS.....	89	SUTURESCISSORS HEATH.....	66
SPREADER DAVIS-BOYLE.....	455	STRATTE NEEDLE HOLDER.....	212	SUTURESCISSORS LITTAUER.....	66
SPREADER DAVIS-MEYER.....	457	STRAUSS PENISCLAMP.....	553/1	SUTURESCISSORS NORTHBENT.....	66
SPREADER DINGMANN.....	456	STRIPPER.....	202	SUTURESCISSORS SPENCER.....	66
SPREADER KILNER-DOUGHTY.....	456	STRULLY NEUROSURGICAL.....	65	SUTURING SET.....	225
SPURLING LAMINECTOMY RETRACTOR FORCEPS.....	340	STRUYCKEN NOSE FORCEPS.....	427	SWEET APPLIERSFORCEPS.....	326
SPUTUM CUP.....	621	SUBRAMANIAN-MINIATURE.....	521	SYSTRUNK SURGICAL SCISSORS.....	66
SREWHOLDINGFORCEPS LANE.....	325	SUCTION -IRRIGATION CANNULA.....	394		
ST. CLAIR-THOMSON ADENOID CURETTE.....	450	SUCTION HANDLE WULLSTEIN.....	338	T	
ST.MARKS PELVIS-HOOK.....	165	SUCTION RASPATORIES GUILLEN.....	433/1	TABB KNIVES.....	418
ST.MARTIN TISSUE FORCEPS.....	392	SUCTION TUBE ADSON.....	337	TABLET TRAY.....	621
STACKE EARPROBES.....	199	SUCTION TUBE ANDREW-PYNCHON.....	28	TAKAHASHI NOSE FORCEPS.....	427
STAMMBERGER FORCEPS.....	431	SUCTION TUBE BABY-YANKAUER.....	27	TANGENTIALCLAMP DEBAKEY-SATINSKY.....	502
STAND.....	188	SUCTION TUBE BARON.....	336	TARNIER CRANIPLAST.....	607
STANDARD SURGICAL SCISSORS.....	51	SUCTION TUBE COOLEY.....	28	TARNIER OBSTETRICAL FORCEPS.....	604
STAUDE-MOORE HOOK FORCEPS.....	582	SUCTION TUBE DASTOOR.....	380	TAYLOR PERCUSSION HAMMER.....	24
STEINMANN ENDER NAIL.....	307, 308	SUCTION TUBE DEBAKEY.....	28	TAYLOR SPINAL HOOK.....	291
STEINMANN TENDON HOLDINGFORCEPS.....	292	SUCTION TUBE FRAZIER/FERGUSSON.....	337	TAYLOR SURGICAL TISSUE FORCEPS.....	87
STELLBRINK BONE RONGEUR.....	234	SUCTION TUBE PLESTER.....	338	TC SCISSORS FREEMAN.....	74
STERILE SCALPEL.....	43	SUCTION TUBE POOLE.....	27	TC SCISSORS PECK-JOSEPH.....	74
STERILE SCALPEL-BLADE.....	42	SUCTION TUBE ROSEN.....	338	TC SCISSORS REES.....	73
STERILE SPARE BLADE.....	50	SUCTION TUBE TUBE KLEINSASSER.....	36	TC SURGICAL SCISSORS FINE REYNOLDS TC.....	54
STERILIZATION CLAMP BUNT.....	227	SUCTION TUBE YANKAUER.....	27	TC SURGICAL SCISSORS STANDARD.....	51
STERILIZATION CLAMP MAYO.....	227	SUCTION TUBE YASARGIL.....	337/1	TC TISSUE FORCEPS CUSHING.....	83
STERILIZATION FORCEPS.....	227	SUCTION TUBE ZOELLNER.....	337/1	TC TISSUE FORCEPS GILLIES.....	86
STERILIZATION FORCEPS.....	227	SUCTION TUBE BEE HOUSE.....	337/2	TC TISSUE FORCEPS SEMKEN.....	86
STERILIZATION FORCEPS CHEATLE.....	227	SUPER CUT SCISSORS.....	71	TC TISSUE FORCEPS SURGICAL.....	81
STERILIZATION FORCEPS REDA.....	615	SUPER CUT SCISSORS BABY METZENBAUM.....	71	TC TISSUE FORCEPS WANGENSTEEN.....	89
STERILIZATION FORCEPS ROGGE.....	227	SUPER CUT SCISSORS FREEMAN.....	74	TC TISSUE FORCEPS ANATOMIC.....	81
STERILIZATION FORCEPS UNIVERSAL.....	227	SUPER CUT SCISSORS GORNEY.....	73	TC-SCISSORS GORNEY.....	73
STERILIZATION TRAY.....	622, 623	SUPER CUT SCISSORS IRIS.....	72	TC-SCISSORS KAYE.....	73
STERILIZATION TRAY.....	616, 618	SUPER CUT SCISSORS KAYE.....	73	TEALE HOOK FORCEPS.....	583
STERNBERG CHEEK RETRACTOR.....	453	SUPER CUT SCISSORS KILNER/RAGNELL.....	72	TEBBETTS RETRACTOR.....	197
STERNUM SCISSORS SCHUMACHER.....	481	SUPER CUT SCISSORS LAGRANGE.....	72	TEETH TISSUE FORCEPS LONDON-COLLEGE.....	93
STERNUMCHISELS LEBSCHER.....	267	SUPER CUT SCISSORS LISTER.....	72	TEETH TISSUE FORCEPS MERIAM.....	93
STETHOSCOPE ANESTOPHON.....	23	SUPER CUT SCISSORS MAYO.....	71	TENDON GRASPING FORCEPS.....	293
STETHOSCOPE DUPLEX.....	23	SUPER CUT SCISSORS MAYO-STILLE.....	71	TENDON GRASPING FORCEPS JACKSON.....	292
STETHOSCOPE PINARD.....	23	SUPER CUT SCISSORS METZENBAUM.....	71	TENDON GRASPING FORCEPS LARSEN.....	292
STEVENS IRIS TISSUE FORCEPS.....	383	SUPER CUT SCISSORS REES.....	73	TENDON GRASPING INSTR KLEINERT-KUTZ.....	294
STEVENS LINSENHOK.....	375	SUPER CUT SCISSORS REYNOLDS.....	72	TENDON GRASPING INSTRUMENT BRAND.....	293
STEVENS NEEDLE HOLDER.....	214	SUPER CUT SCISSORS STEVENS.....	72	TENDON GRASPING INSTRUMENT CAROLL.....	293
STEVENS OPHTHALMOLOGIC SCISSORS.....	58	SUPER CUT SCISSORS WAGNER.....	72	TENDON GUIDE BUNELL.....	294
STEVENS SUPER CUT SCISSORS.....	72	SURGICAL NEEDLE.....	222, 223	TENDON HOLDINGFORCEPSSTEINMANN.....	292
STEVENSON EYE SPECULA.....	371	SURGICAL NEEDLE KEITH.....	223	TENDON PASSING INSTR. BRAND.....	294
STIEGLITZ SPLINTERFORCEPS.....	92	SURGICAL NEEDLE KOENIG.....	223	TENDON PASSING INSTR. BUNNELL.....	292
STILLE ANATOMIC TISSUE FORCEPS.....	81	SURGICAL SCISSORS FERGUSSON.....	66	TERSON CAPSULAR FORCEPS.....	391
STILLE BONE HAND DRILLS.....	298	SURGICAL SCISSORS FINE IRIS.....	54	TESSIER RETRACTOR.....	463/3
STILLE CHISELS.....	260	SURGICAL SCISSORS FINE JOSEPH.....	54	T-HANDLE.....	300, 301
STILLE CHISELS.....	260	SURGICAL SCISSORS FINE KILNER.....	54	T-HANDLE HUDSON.....	300
STILLE GOUGES.....	260	SURGICAL SCISSORS FINE REYNOLDS.....	54	THOMAS UTERINE CURETTE.....	599
STILLE HEMOSTATIC CLAMP.....	122	SURGICAL SCISSORS FINE SANVENERO.....	54	THOMAS-GALLOR BIOPSY FORCEPS.....	588
STILLE PLASTERSCISSORS.....	229	SURGICAL SCISSORS METZENBAUM.....	51, 54	THOMS-ALLIS BOWEL GRASPING FORCEPS.....	538

THOMSON-WALKER BLADDER RETRACTORS.....	552	TONSIL ELEVATOR HURD.....	465	TRAY UNIVERSAL.....	620
THORACIC SPREADER MERCEDES.....	489	TONSIL ELEVATOR LOPEZ-REINKE.....	465	TRELAT TONSIL NEEDLE.....	466
THOREK SCISSORS.....	65/2	TONSIL ELEVATOR YANKAUER.....	465	TRELAT VAGINAL SPECULA.....	571
THUDICHUM NOSE SPECULA.....	421	TONSIL FORCEPS BALLENGER.....	467	TROCAR COAKLEY.....	204
THYROID GLAND HOOK SCHOENBORN.....	479	TONSIL FORCEPS BLOHMKE.....	467	TROCAR DOUGLAS.....	205
TIECK-HALLE NOSE SPECULA.....	423	TONSIL FORCEPS MARSCHIK.....	468	TROCAR LICHTWITZ.....	204
TILLEY EAR FORCEPS.....	411	TONSIL FORCEPS NEGUS.....	467	TROCAR NELSON.....	205
TILT MECHANIC.....	194	TONSIL FORCEPS SAWTELL.....	467	TROCAR OCHSNER.....	205
TIP FOR SUCTION TUBE.....	27	TONSIL FORCEPS SCHNIDT.....	467	TROCAR PIERCE.....	204
TISCHLER-DOWN BIOPSY FORCEPS.....	591	TONSIL FORCEPS TYDING.....	467	TROCAR UNIVERSAL.....	204
TISCHLER-KEVORKIAN BIOPSY FORCEPS.....	592	TONSIL FORCEPS WHITE.....	467	TROCARSTANDARD (NELSON).....	204
TISCHLER-MORGAN BIOPSY FORCEPS.....	591	TONSIL GRASPING FORCEPS COLVER.....	467	TROELTSCH EAR FORCEPS.....	424
TISCHLER-MORGAN BIOPSY FORCEPS.....	590, 591	TONSIL NEEDLE.....	470	TROEMNER PERCUSSION HAMMER.....	24
TISCHLER-UP BIOPSY FORCEPS.....	591	TONSIL NEEDLE CLAU.....	466	TROUSSEAU TRACHEA DILATOR.....	476
TISSUE FORCEPS.....	90, 94	TONSIL NEEDLE DUPUY-WEISS.....	466	TROUSSEAU-BABY TRACHEA DILATOR.....	476
TISSUE FORCEPS ANATOMIC.....	81	TONSIL NEEDLE NAGER.....	466	TROUTMAN IRIS TISSUE FORCEPS.....	389
TISSUE FORCEPS BIPOLAR.....	630, 631	TONSIL NEEDLETRLAT.....	466	TROUTMAN IRIS TISSUE FORCEPS.....	384, 389
TISSUE FORCEPS BONNEY.....	88	TONSIL SCISSORS.....	59	TROUTMAN-CHRIS BLADEBREAKERS.....	45
TISSUE FORCEPS BROWN.....	83	TONSIL SCISSORS BOETTCHER.....	59	TUBAL CATHETER.....	596
TISSUE FORCEPS CASTROVIEJO.....	392	TONSIL SCISSORS DEAN.....	59	TUBBS AORTIC DILATOR.....	528
TISSUE FORCEPS DAVIS.....	227	TONSIL SCISSORS GOOD.....	59	TUBING ASSEMBLY.....	188
TISSUE FORCEPS DEBAKEY.....	99	TONSIL SCISSORS PRINCE.....	59	TUBING CLAMP HOFFMANN.....	624
TISSUE FORCEPS GERALD.....	86, 87	TONSIL SNARE BRUENINGS.....	468	TUBING CLAMP SIMPLEX.....	624
TISSUE FORCEPS GOMEL.....	96	TONSIL SNARE EVES.....	468	TUBINGCLAMP.....	129
TISSUE FORCEPS GRAEFE.....	83	TONSIL SYRINGE.....	470	TUBINGCLAMPBÜLOW-GUNAR-HEY.....	130
TISSUE FORCEPS JEWELRY.....	90	TONSIL WIRE.....	468	TÜBINGEN TISSUE FORCEPS.....	392
TISSUE FORCEPS MAYO.....	89	TONSIL-ELEVATOR HENKE.....	465	TUFFIER RETRACTOR.....	147
TISSUE FORCEPS MCPHERSON.....	392	TONSIL-KNIVES ABRAHAM.....	466	TUFFIER RIB SPREADER.....	487
TISSUE FORCEPS MOORFIELD.....	392	TONSIL-KNIVES BRUENINGS.....	466	TUFFIER TISSUE GRASPING FORCEPS.....	110
TISSUE FORCEPS PAUFIQUE.....	392	TONSIL-KNIVES CANFIELD.....	466	TUMOR GRASPING FORCEPS LANDOLT.....	341
TISSUE FORCEPS SINGLEY.....	88	TONSIL-KNIVES CARPENTER.....	465	TUMORTISSUE FORCEPS YASARGIL.....	97
TISSUE FORCEPS STRASSBURGER MODELL.....	89	TONSIL-KNIVES DOUGLAS.....	466	TUNING FORC.....	404
TISSUE FORCEPS TYPE TUEBINGEN.....	392	TONSIL-KNIVES FISHER.....	466	TUNING FORC HARTMANN.....	403
TISSUE FORCEPS ULTRA LIGHT.....	95	TONSILOTOME SLUDER-BALLENGER.....	470	TUNING FORC LUCAE.....	404
TISSUE FORCEPS WAGENSTEEN.....	89	TONSILOTOME TYDING.....	469	TUNING FORC REDA.....	403
TISSUE FORCEPS YASARGIL.....	97	TOOK CORNEAL SCARIFIER.....	373	TUNING FORC RYDEL-SEIFFERT.....	404
TISSUE FORCEPS YAST.....	392	TOURNIQUET RUMEL-BELMONT.....	528	TURNBULL NAIL FORCEPS.....	609
TISSUE GRASPING FORCEPS CHAPUT.....	110	TOWEL CLAMP.....	133	TURREL RECTAL BIOPSY FORCEPS.....	567
TISSUE GRASPING FORCEPS COLLIN.....	110	TOWEL CLAMP BACKHAUS.....	132	TYDING TONSIL FORCEPS.....	467
TISSUE GRASPING FORCEPS TUFFIER.....	110	TOWEL CLAMP BACKHAUS-CLIP.....	132	TYDING TONSILOTOME.....	469
TITANIUM CLIPS.....	549	TOWEL CLAMP BALL AND SOCKET.....	133	TYPE TUBINGEN IRIS FORCEPS.....	387
TITANIUM HALSTED-MOSQUITO HEMOSTATIC CLAMP.....	105	TOWEL CLAMP BERNHARD.....	133	TYPE MÜNCHEN BIOPSY CURETTE.....	587
TITANIUM HEMOSTATIC CLAMP CRILE.....	107	TOWEL CLAMP DOYEN.....	133	TYPE VIENNA NOSE SPECULA.....	421
TITANIUM HEMOSTATIC CLAMP KELLY.....	106	TOWEL CLAMP JONES.....	132		
TITANIUM TISSUE FORCEPS DEBAKEY.....	99	TOWEL CLAMP JONES-CLIP.....	132	U	
TITANIUM-ATRAUMA-BULLDOG CLAMP.....	102	TOWEL CLAMP LANE.....	133	UCKERMANN COTTON-APPLICATOR.....	203
TOBOLD COTTON-APPLICATOR.....	203	TOWEL CLAMP LORNA.....	133	ULRICH BONE HOLDING FORCEPS.....	248
TOBOLD TONGUE DEPRESSORS.....	453	TOWEL CLAMP MOYNIHAN.....	133	ULRICH DRESSINGFORCEPS.....	135
TOENNIS DURA DISSECTOR.....	332	TOWEL CLAMP PEERS.....	132	ULTRA-LIGHT-TISSUE FORCEPS ATRAUMA.....	95
TOENNIS HEMOSTATIC CLAMP.....	117	TOWEL CLAMP ROEDER.....	132	UMBILICAL CORD SCISSORS BRAUN-STADLER.....	64
TOENNIS-ADSON DISSECTING SCISSORS.....	65	TOWEL CLAMP SCHAEDEL.....	132	UMBILICAL CORD SCISSORS BUSCH.....	64
TOHUKU TOWEL CLAMP.....	132	TOWEL CLAMP TOHOKU.....	132	UMBILICAL CORD SCISSORS SCHUMACHER.....	64
TONGUE BLADE DOUGHTY.....	458	TOWNLEY CALIPER.....	26	UMBILICAL CORD SCISSORS TYPE USA.....	64
TONGUE DEPRESSORS.....	451	TOWNSEND BIOPSY FORCEPS.....	591	UNI I DIAGNOSTIK-BES.....	13
TONGUE DEPRESSORS ANDREW.....	452	TOWNSEND MINI BIOPSY FORCEPS.....	591	UNI III DIAGNOSTIK-BES.....	15
TONGUE DEPRESSORS BRUENINGS.....	451	TOWNSEND TISCHLER MINI BIOPSY FORCEPS.....	591	UNIVERSAL BANDAGE SCISSORS.....	70
TONGUE DEPRESSORS BUCHWALD.....	451	TOYNBEE EAR SPECULA.....	399	UNIVERSAL ENDOSCOPE ASSEMBLY.....	188
TONGUE DEPRESSORS DAVIS-BOYLE.....	455	TRACHEA CANNULA LUER.....	479	UNIVERSAL STERILIZATION FORCEPS.....	227
TONGUE DEPRESSORS DINGMANN.....	456	TRACHEA CANNULA WAGENER-MOSHER.....	477	UNIVERSAL TRAY.....	620
TONGUE DEPRESSORS FRENZEL.....	451	TRACHEA CANNULACHEVALIER-JACK.....	479	UNIVERSAL TROCAR.....	204
TONGUE DEPRESSORS HARTMANN.....	452	TRACHEA DILATATOR. LABORDE.....	476	UNIVERSAL WIRESCISSORS.....	67
TONGUE DEPRESSORS KILNER-DOUGHTY.....	456	TRACHEA DILATOR. TROUSSEAU.....	476	UNIVERSALHANDLE HUBER.....	472
TONGUE DEPRESSORS KROENIG.....	451	TRACHEA DILATORTROUSSEAU-BABY.....	476	UNNA COMEDONE EXTRACTOR.....	608
TONGUE DEPRESSORS MAYO.....	451	TRACHEA HOOK BOSE.....	476, 477	URETHROTOME OTIS.....	553
TONGUE DEPRESSORS MORITZ-SCHMIDT.....	452	TRACHEA HOOK ITERSON.....	477	US ARMY RETRACTOR.....	141
TONGUE DEPRESSORS RING.....	455	TRACHEA HOOK JACKSON.....	476	USA ANATOMIC TISSUE FORCEPS.....	81
TONGUE DEPRESSORS RUSSEL-DAVIS.....	458	TRACHEA HOOK NEWS.....	477	USA TYPE UMBILICAL CORD SCISSORS.....	64
TONGUE DEPRESSORS TOBOLD.....	453	TRACHEOTOMY-SET.....	478	UTERINE CURETTE SIMON.....	594
TONGUE DEPRESSORS WIEDER.....	452	TRACHOMA FORCEPS KNAPP-LUER.....	393	UTERINE CURETTE BLAKE.....	595
TONGUE FORCEPS COLLIN.....	453	TRANSFORMATOR.....	22	UTERINE CURETTE BUMM.....	597
TONGUE FORCEPS YOUNG.....	453	TRANSFORMER FOR LARYNGOSCOPE HANDLE.....	34	UTERINE CURETTE GOURDET STUMPF.....	599
TONOMETER SCHIOETZ.....	394/2	TRAVERS RETRACTORS.....	172	UTERINE CURETTE RECAMIER.....	597
TONSIL FORCEPS ABRAHAM.....	468	TRAY.....	619	UTERINE CURETTE SCHRÖDER.....	595

UTERINE CURETTE SIMS	597	VERBRUGGE BONE HOLDING FORCEPS	245	WILLIAMS SCREW DRIVER	323
UTERINE CURETTE THOMAS	599	VERBRUGGE-MÜLLER BONE LEVERS	287	WILLIGER CURETTE	255, 257
UTERINE DILATATOR GOODELL	581	VERESS INSUFFLATION CANNULA	206	WILLIGER HAMMER	271
UTERINE DILATATOR HANK	580	VIENNA GUIDEPROBES	221	WILLIGER RASPTORIES	276
UTERINE DILATATOR HEGAR	578, 579	VIRCHOW POST MORTEM KNIVES	48	WINTER OVUM FORCEPS	606
UTERINE DILATATOR PRATT	580	VIRTUS(RALK) SPLINTER	92	WIRE BASKET FOR ENDOSCOPE	623
UTERINE DILATATOR SIMS	581	VOLKMANN BONE CURETTES	251	WIRE FORCEPS	317, 318
UTERINE DILATATOR WYLIE	581	VOLKMANN CURETTE	257	WIRE FORCEPS BERRY TC	319
UTERINE POLYP FORCEPS DOYEN	585	VOLKMANN RETRACTOR	153	WIRE FORCEPS CORWIN-HEGAR TC	319
UTERINE POLYP FORCEPS KELLY	585	VOLKMANN RETRACTOR	153, 156	WIRE FORCEPS MAYO-HABERISSER TC	319
UTERINE POLYP FORCEPS NOTO	585	VOLTOLINI NOSE SPECULA	421	WIRE GAUZE	311
UTERINE-DEPRESSOR BRAUN	586	VU-MORE VAGINAL SPECULA	569	WIRE GRASPING FORCEPS	318
UTERINE-DEPRESSOR SIMS	586			WIRE GUIDE NEEDLE DEMEL	315
UTERINE-GRASPING FORCEPS COLLIN	585	W		WIRE INSTRUMENT DEMEL	315
UTERINE-GRASPING FORCEPS DARTIGUES	585	WACHENFELDT CLIP TISSUE FORCEPS	224	WIRE INSTRUMENT LOUËTE	315
UTERINE-GRASPING FORCEPS SOMER	585	WADSWORTH-TODD CAUTER	378	WIRESAW OLIVECRONA	332
UTERINE-KL.FORCEPSGREEN-ARMYTAGE	605	WAGENER-MOSHER TRACHEA CANNULA	477	WIRESCISSORS UNIVERSAL	67
UTERINE-PROBES COLLIN	586	WAGNER HOOK	409	WITNER BIOPSY FORCEPS	589
UTERINE-PROBES MARTIN	586	WAGNER LAMINECTOMY RETRACTOR FORCEPS	343	WOLFF PLASTER FORCEPS	233
UTERINE-PROBES SIMS	586	WAGNER SCISSORS	67	WOODSON DURA DISSECTOR	333
		WAGNER SUPERCUT SCISSORS	72	WORST PROBES	333
V		WALDMANN EPISOTOMY SCISSORS	64	WOUND CURETTE ARRUGA	378
VAGINAL SPECULA	569	WALLICH OVUM CURETTE	607	WRIGLEY OBSTETRICAL FORCEPS	602
VAGINAL SPECULA JACKSON	573	WALSHAM SEPTUM STRAIGHTENING FORCEPS	449	WULLSTEIN KNIVES	418
VAGINAL SPECULA AUVARD	576	WALTON FOREIGN-BODY GOUGES	374	WULLSTEIN MICRO-CURETTE FORCEPS	416
VAGINAL SPECULA BREISKY	577	WALTON COMEDONE EXTRACTOR	608	WULLSTEIN RETRACTORS	171
VAGINAL SPECULA COLLIN	570	WALTON FINGER RING SAW	297	WULLSTEIN SUCTION HANDLE	338
VAGINAL SPECULA CUSCO	570	WANGENSTEIN VASCULAR TISSUE FORCEPS	89	WYLIE UTERINE DILATOR	581
VAGINAL SPECULA DOYEN	574	WARTENBERG PINWHEEL	25		
VAGINAL SPECULA GRAVE	570	WASTEFORCEPS SAUERBRUCH	227	Y	
VAGINAL SPECULA KRISTELLER	572	WATER JET PISTOL	626	YANCOSKIE RETRACTOR	198
VAGINAL SPECULA LANDAU	577	WATSON DERMATOM	50	YANKAUER SUCTION TUBE	27
VAGINAL SPECULA PEDERSON	570	WATSON DERMATOM	50	YANKAUER TONSIL DISSECTOR	465
VAGINAL SPECULA SEMM	571	WATSON-CHEYNE	283	YASARGIL ANEURYSM	349, 350, 351, 352, 353, 354, 355, 356
VAGINAL SPECULA SIMS	573	WATSON-CHEYNE PROBES	199	YASARGIL GALEAHOOK	330
VAGINAL SPECULA TRELAT	571	WATSON-WILLIAMS NOSE FORCEPS	428	YASARGIL SUCTION TUBE	337/1
VAGINAL SPECULA VU-MORE	569	WAUGH SURGICAL TISSUE FORCEPS	83	YASARGIL TUMORTISSUE FORCEPS	97
VAGINAL SPECULASCHERBAK	575	WEBER BLOOD VESSEL CLAMP	501	YEOMAN RECTAL BIOPSY FORCEPS	566, 567
VALLEIX PROBES	586	WEBER CATARACT LOOP	378	YOUNG BOOMERANG	220
VAN BUREN BONE HOLDING FORCEPS	249	WEBSTER NEEDLE HOLDER	208	YOUNG PROSTATIC HOOK	550
VAN BUREN DILATION BOUGIE	554	WECKER EYESCISSORS	75	YOUNG TONGUE FORCEPS	453
VAN DOREN BIOPSY FORCEPS	588	WECKER IRIS SPATULA	378		
VANNAS EYESCISSORS	79	WEEK EYE SPECULA	370	Z	
VARADY VARIX INSTRUMENT	202	WEIL-BLAKESLEY NOSE FORCEPS	426	ZAUFAL EAR LEVER	409
VARICOSE VEIN PROBES NABATOFF	201	WEITLANER RETRACTORS	169	ZAUFAL-JANSEN BONE RONGEUR	238
VARIX INSTRUMENT VARADY	202	WEITLANER-WULLSTEIN RETRACTORS	169	ZAUFAL-JANSEN EAR LEVER	409
VASCULAR CLAMP BAINBRIDGE	495	WELLER DISSECTING SCISSORS	53/2	ZENKER HEMOSTATIC CLAMP	118
VASCULAR CLAMP COOLEY	518, 522	WELLS ENUCULATION CURETTE	378	ZENKER RETRACTOR	161
VASCULAR CLAMP DE BAKEY	495	WERTHEIM GYNECOLOGICAL SCISSORS	63	ZIEGLER DISCISION KNIVES	373
VASCULAR CLAMP DEBAKEY	507, 514, 515	WERTHEIM HYSTERECTOMY CLAMP	124, 128	ZIEGLER EYE SPECULA	371
VASCULAR CLAMP DEBAKEY CHILDREN	516	WERTHEIM HYSTERECTOMY SCISSORS	63	ZIEGLER HEAD MIRRORS	21
VASCULAR CLAMP GLOVER	515	WERTHEIM-CULLEN HYSTERECTOMY CLAMP	125	ZIEGLER IRIS KNIVES	372
VASCULAR CLIP BIEMER	361	WEST NOSE CHISELS	442	ZIEGLER LACHRYMAL DILATOR	381
VASCULAR CLIP MEHDORN	362	WESTCOTT EYESCISSORS	75	ZIELKE GOUGES	264
VASCULAR CLIP MUELLER	365	WESTMACOTT NOSE DRESSING FORCEPS	424	ZOELLNER SUCTION TUBE	337/1
VASCULAR SCISSORS DE BAKEY	61	WESTON RECTALSNARE	566		
VASCULAR SCISSORS DEBAKEY TC	60	WHEELER CYCLODIALYSIS SPATULA	379		
VASCULAR SCISSORS DIETRICH	60	WHEELER DISCISION KNIVES	373		
VASCULAR SCISSORS FAVALORO	61	WHITE TONSIL FORCEPS	467		
VASCULAR SCISSORS KELLY	61	WIBERG RASPTORIESUM	277		
VASCULAR SCISSORS POTTS-SMITH	61	WIEDER TONGUE DEPRESSORS	452		
VASCULAR-CANNULA SCHMID	338	WIENER ANTRUM RASP	443		
VASCULAR-DILATOR DEBAKEY	529	WIENER IRIS HOOK	375		
VASCULARDISSECTOR ROBB	530	WIGMORE PLASTER KNIVES	229		
VASCULARSCISSORS KLINKENBERG-LOTH	65/2	WIKSTROEM HEMOSTATIC CLAMP	117		
VASCULARSCISSORS POTTS-DE MARTEL	59	WILDE POLYP SNARE	411		
VASCULARSCISSORS SATINSKY	65/1	WILDE POLYP SNARE	433/2		
VASCULARSCLAMP DIEFFENBACH	104	WILDE(TROELTSCH) EAR FORCEPS	410		
VASCULARSCLAMP SATINSKY	491	WILDER PROBE	381		
VASCULARTISSUE FORCEPS ADLERKREUTZ	84	WILDER CATARACT LOOP	378		
VASCULARTISSUE FORCEPS NELSON	89	WILLET MARTEL GRASPING FORCEPS	110		
VASCULARTISSUE FORCEPSSTILLE-BARRAYA	88	WILLIAMS BOWEL GRASPING FORCEPS	539		
VASEKTOMIECLAMP	553/2	WILLIAMS EYE SPECULA	370		

Abraham bisturi para amigdalas.....	466	alicate corta-uñas Anvil.....	613	Backhaus-Clip pinza de campo.....	132
Abraham pinza para coger amigdalas.....	468	alicate cuticular.....	613	Bailey aproximador para costillas.....	489
abre-boca Davis-Boyle.....	455	alicate Grip.....	316	Bailey-Baby aproximador para costillas.....	489
abre-boca Davis-Meyer.....	457	alicate para cortar uñas Turnbull.....	609	Bailey-Gibbon aproximador para costillas.....	489
abre-boca Denhart.....	454	alicates.....	316-318, 320	Bainbridge pinza hemostatica.....	119/2
abre-boca Dingmann.....	456	alicates para cortar alambres.....	316-318, 320	Bainbridge pinza vascular de uso multiple.....	495
abre-boca Doyen-Jansen (Molt).....	454	Allen pinza para apendice.....	544	baja-lengua Andrew.....	452
abre-boca Heister.....	454	Allis pinza intestinal.....	537	baja-lengua Bruenings.....	451
abre-boca Jennings.....	454	Allis-Adair pinza intestinal.....	537	baja-lengua Buchwald.....	451
abre-boca Kilner-Doughty.....	456	Allis-Baby pinza intestinal.....	537	baja-lengua Cavood-Minnesota.....	451
abre-boca Mclvor.....	457	Allsion espátula pulmonar.....	489	baja-lengua Doughty.....	458
abre-boca Roser-Koenig.....	454	Alm separador.....	168	baja-lengua Frenzel.....	451
aceite para instrumentos Instru Care.....	634	Alvis cureta para cuerpos extraños.....	374	baja-lengua Hartmann.....	452
adaptador para iluminacion para amioscopio.....	600	amigdalotomo Sluder-Ballenger.....	470	baja-lengua Kroening.....	451
adenotomo LaForce.....	450	amigdalotomo Tyding.....	469	baja-lengua Mayo.....	451
Adlerkreutz pinza de diseccion.....	84	amniotomo.....	586, 600	baja-lengua Moritz-Schmidt.....	452
Adson Baby pinza hemostatica.....	113	amniotomo Beacham.....	586	baja-lengua Ring.....	455
Adson elevador.....	282	Anderson Adson separador.....	172	baja-lengua Russel-Davis.....	458
Adson gancho para dura-madre.....	329	Anderson separador.....	198	baja-lengua Tobold.....	453
Adson pinza de diseccion.....	81/2, 82	Andrew baja-lengua.....	452	baja-lengua Wieder.....	452
Adson pinza de proteccion.....	298	ANDREW-PYNCHON tubo de aspiracion.....	28	baja-lenguas.....	451, 452, 453, 455
Adson pinza guia.....	236	ANESTOPHON estetoscopio.....	23	Bakes dilatador para conductos biliares.....	532
Adson pinza hemostatica.....	112, 113	anillo para KLEINSASSER.....	36	Balfour Baby separador abdominal.....	182, 183
Adson pinza para hipofisis.....	334	anoscopio Chelsea-Eaton.....	563	Balfour separador abdominal.....	182, 183
Adson porta aguja.....	211	anoscopio Hirschmann.....	562	Balfour-Us separador abdominal.....	184
Adson separador.....	172, 173, 174	anoscopio Ives-Fansler.....	562	Ball and Socket pinza para campo.....	133
Adson tubo de aspiracion.....	337	anteojos para nistagmo FRENZEL.....	20	Ballenger cuchillo para tabique nasal.....	436
Adson-Brown pinza de diseccion.....	82	Antrum cureta.....	435	Ballenger elevador para el tabique nasal.....	439
Adson-DeBakey pinza de diseccion.....	81/2	Anvil alicate corta-uñas.....	613	Ballenger pinza para coger amigdalas.....	467
AEBLI tijera corneal.....	58	aparato para suturar estomago y.....		bandejas.....	620
agrafe MICHEL.....	224	intestinos V. Petz.....	549	Bane-Hartmann pinza guia.....	237
aguja Barbara.....	419	aproximador de Biemer.....	366	Bangerter espátula para ciclodialisis.....	379
aguja de discision Bowman.....	374	aproximador de Biemer-Müller.....	363	Baracani punta de pinza.....	472
aguja de guia para anestesia.....	206	aproximador de Müller.....	364	Barany esordecedor.....	405
aguja de guia REDON.....	207	aproximador para costillas Bailey.....	489	Barbara aguja.....	419
aguja para amigdalas.....	470	aproximador para costillas Bailey-Baby.....	489	Barbara gancho.....	419
aguja para autopsia.....	268	aproximador para costillas Bailey-Gibbon.....	489	Barkan cuchillo para goniotomia.....	373
aguja para biopsia Franklin-Silvermann.....	206	Archer pinza para espinas.....	92	Barnhill cuchillo para vegetaciones adenoides.....	450
aguja para biopsia Menghini.....	206	Arit asa.....	378	Baron canula de succion.....	336
aguja para catarata.....	374	Arruga blefarostato.....	370	Barr especulo rectal.....	559
aguja para cuerpos extraños.....	374	Arruga gancho para extraccion.....	375	barra de traccion Gerster.....	250
aguja para cuerpos extraños Davis.....	374	Arruga pinza capsular.....	391	Barraquer (Colibri) blefarostato.....	370
aguja para cuerpos extraños Francis.....	374	Arruga porta aguja.....	214	Barraquer (Colibri) pinza para iris.....	384
aguja para cuerpos extraños Levinson.....	374	Arruga protector.....	378	Barraquer Colibri tijera para oftalmologia.....	75
aguja para laringe.....	470	articulacion para KLEINSASSER.....	36	Barraquer cuchillo para queratoplastica.....	373
aguja para ligadura.....	218, 219	asa Arit.....	378	Barraquer micro porta aguja.....	216, 217
aguja para ligadura Cooper.....	219	asa Billeau.....	409	Barraquer pinza depilatoria.....	395
aguja para ligadura Deschamps.....	218	asa Langenbeck.....	409	Barraquer pinza para fijacion.....	390
aguja para ligadura Kronecker.....	219	asa Shapleigh.....	410	Barraquer-Katzin pinza para iris.....	384
aguja para ligadura Nelson.....	219	asa Snellen.....	378	Barraquer-Troutmann micro porta aguja.....	216
aguja para ligadura Schmieden-Dick.....	219	asa Weber.....	378	Barrett pinza uterina.....	582
aguja para neumoperitoneo Verres.....	206	asa Wilder.....	378	Barton forceps obstetrico.....	603
aguja para paracentesis Lucae.....	408	Asch pinza para enderezar el tabique nasal.....	449	Barton tractor.....	603
aguja para paracentesis Politzer.....	408	Aufranc-Cobra separador.....	289	Baumgartner porta aguja.....	208
aguja para sutura amigdalas Dupuy-Weiss.....	466	Aufricht lima nasal.....	443	Beacham amniotomo.....	586
aguja para sutura del paladar Claus.....	466	Aufricht retractor nasal.....	447	Bechert rotador.....	379
aguja para sutura del paladar Claus-Eicken.....	466	Auward especulo vaginal.....	576	Beck pinza para anastomosis.....	516, 520
aguja para sutura del paladar Nager.....	466	Axenfeld cucharilla para chalazion.....	377	Becker quistotomo.....	375
aguja pasa-hilo Demel.....	315	Ayer pinza para ligadura.....	393	Beckmann cuchillo para vegetaciones adenoides.....	450
aguja Reverdin.....	220			Beckmann separador.....	176
aguja Yound Boomerang.....	220			BECKMANN-ADSON separador.....	175
agujas de sutura.....	222, 223			Beckmann-Eaton separador.....	176
Air Injection canula.....	394	B		Beebee tijera para coronas.....	68
alambre de Kirschner.....	306, 307	Babcock pinza intestinal.....	539	Beer pinza depilatoria.....	395
alambre de Steinmann.....	307, 308	BABINSKI martillo de percusion.....	24	Beeson separador para yesos.....	232
alambres.....	306, 307, 308, 309	Baby Burke pinza para biopsia.....	590	Bellucci tijera auricula micro.....	413, 417
Alan-Parks especulo rectal.....	561	Baby Gosset separador abdominal.....	181	Bengolea pinza hemostatica.....	112
Alderdyce elevador.....	282	Baby Metzenbaum tijera supercut.....	71	Bennett elevador.....	283
Alexander cincel.....	259	Baby-Kocher pinza intestinal.....	540	Bensaude protoscopio.....	565
Alexander guia.....	259	Baby-Olsen-Hegar porta aguja.....	212	Benson separador para piloro.....	544
Alexander periostotomo.....	276	BABYPHON esfigmomanometro.....	10	Berens cuchillo de discision.....	372
Alexander pinza para biopsia.....	589	Baby-Tischler pinza para biopsia.....	592	Bergmann martillo.....	272
alicate corta-uñas.....	609, 612/2, 613, 614	BABY-YANKAUER tubo de aspiracion.....	27	Bergmann tijera para vendaje.....	69/1

Berke pinza muscular.....	389	Bozemann-Douglas pinza porta esponja.....	138	canula irrigacion Eicken (Kilian).....	433
BERLINER martillo de percusion.....	24	Brand mondador de tendones.....	294	canula Kilian.....	433/1
Bernhard pinza de campo.....	133	Brand pinza de agarre para tendones.....	293	canula Lacrimal.....	394
Berry pinza para torcer hilo.....	319	Braun cranioclasto.....	607	canula lacrimal McIntyre.....	394
Bethune costotomo.....	481	Braun depresor uterino.....	586	canula para lavador vascular Schmid.....	338
Beyer pinza gubia.....	237, 238	Braun gancho de decapitacion.....	607	canula para traqueotomia Chevalier-Jackson.....	479
Biemer aproximador.....	366	Braun pinza uterina.....	582	canula para traqueotomia Luer.....	479
Biemer pinza para vasos.....	361	Braun-Stadler tijera para episiotomia.....	64	canula para traqueotomia Wagoner-Mosher.....	477
Biemer-Müller aproximador.....	363	brazalete para brazo.....	295	canula Sheets.....	394/2
Bier sierra para amputacion.....	296	brazalete para femur.....	295	canula Simcoe.....	394/2
Bill tractor.....	604	Breast separador mamaio.....	198	Carmalt pinza para espinas.....	91
Billeau asa.....	409	Breisky especulo vaginal.....	577	Caroll pinza de agarre para tendones.....	293
Bircher-Ganske pinza para hueso.....	246	Bridge pinza hemostatica.....	116	Carpenter cuchillo para amigdales.....	465
Birkett pinza hemostatica.....	116	Bristow elevador.....	290	Caspar hemostatico.....	258
Bishop-Harman pinza para iris.....	386	Brodie sonda acanalada.....	199	Caspar separador.....	179, 180
Bishop-Harmon canula de irrigacion y aspiracion.....	394/1	Brophy pinza de diseccion.....	84	Castaneda pinza vascular para neonatales.....	527
bisturi nasal Joseph.....	434, 435	Brown pinza de diseccion.....	83	Castroviejo bleararostato.....	371
bisturi para amigdalas Abraham.....	466	Brown porta aguja.....	209	Castroviejo compas marcador.....	380
bisturi para amigdalas Bruenings.....	466	Bruenings baja-lengua.....	451	Castroviejo cuchillo para discision.....	372
bisturi para amigdalas Canfield.....	466	Bruenings bisturi para amigdalas.....	466	Castroviejo dilatador lacrimal.....	381
bisturi para amigdalas Douglas.....	466	Bruenings cierranudos.....	468	Castroviejo espátula para ciclodialis... ..	379
bisturi para amigdalas Fisher.....	466	Bruenings especulo auricular.....	401	Castroviejo pinza capsular.....	391
bisturi para fibroma Segond.....	594	Bruenings pinza nasal.....	425	Castroviejo pinza para fijacion.....	390
bisturíes.....	46	Bruenings punta de pinza.....	472	Castroviejo pinza para sutura.....	392
Blake curetas uterinas.....	595	Bruenings tubo de extension.....	472	Castroviejo porta aguja.....	215
Blake pinza para calculos biliares.....	531	Brunetti cincel.....	268	CASTROVIEJO rompe hojas.....	45
blefarostato Arruga.....	370	Brünings-Lucas cincel.....	260	Castroviejo tijera para corneales.....	79
blefarostato Barraquer (Colibr).....	370	Brünings-Lucas gubia.....	260	Castroviejo tijera para iridectomia.....	79
blefarostato Bowman.....	370	Brunner costotomo.....	481	Castroviejo-Micro porta aguja.....	215
blefarostato Clark.....	370	Brunner pinza intestinal.....	543	Castroviejo-Standard micro porta aguja.....	216
blefarostato Critchett.....	370	Brunner separador.....	167	cateter auricular Hartmann.....	408
blefarostato Graefe.....	370	Brunner sonda conductora.....	221	cateter Coxeter.....	555
blefarostato Lancaster.....	371	Bruns cucharilla cortante.....	251, 254	cateter metalicos.....	555
blefarostato Lister-Burch.....	370	Bruns tijera para vendaje.....	70	CATLIN cuchillo para amputacion.....	44
blefarostato Mellinger.....	370	Bryant pinza para medicacion.....	137	cauterio Wadsworth-Todd.....	378
blefarostato Mellinger-Axenfeld.....	370	Buchwald baja-lengua.....	451	Cawood-Minnesota baja-lengua.....	451
blefarostato Murdock.....	370	Buck cureta.....	407	cepillo para uñas.....	611
blefarostato Smith.....	370	Buck elevador para cuerpos extraños.....	412	cesta de esterilizacion.....	621, 623
blefarostato Week.....	370	BUCK martillo de percusion.....	24	Chandler elevador.....	282
blefarostato Williams.....	370	Buck-Gramcko elevador.....	285	Chapat pinza hemostatica.....	110
blefarostato Ziegler.....	371	Buie canula de aspiracion rectal.....	566	Charnley separador abdominal.....	289
blararostato Castroviejo.....	371	bujia dilatadora Dittel.....	554	Charriere sierra para amputacion.....	296
blararostato Liebermann.....	371	bujia dilatadora Guyon.....	554	Cheatle pinza para esterilizacion.....	227
blararostato Mueller.....	371	bujia dilatadora Van Buren.....	554	Chelsea-Eaton anoscopio.....	563
blararostato Park.....	371	Büllov-Gunar-Hey pinza cierra-tubo.....	130	Cheron pinza porta esponja.....	137
blararostato Stevenson.....	371	Bumm curetas uterinas.....	597	Cherry separador para laminectomia.....	488
Blohmke pinza para coger amigdalas.....	467	Bunell pasador de tendones.....	294	Chevalier-Jackson canula para traqueotomia.....	479
Blount elevador.....	288	Bunell perforador de mano.....	299	Chevalier-Jackson pinza para bronco-esofagoscopia.....	473
Blount separador para rodilla.....	289	Bunell separador para tendones.....	292	Childe pinza para aplicar agrafes.....	224
Blumenthal pinza gubia.....	236	Bunge cucharilla para exenteracion.....	378	cierra-nudo auricular Krause.....	411
Bodenhammer especulo rectal.....	559	Bunt clip para esterilizacion.....	227, 624	cierra-nudo auricular Wilde.....	411
Boerma forceps obstetrico.....	604	Bunt horquilla fijadora.....	373	cierra-nudo rectal Yeoman.....	566
BOETTCHER tijera para amigdalas.....	59	Burke pinza para biopsia.....	590	cierranudos Bruenings.....	468
Böhler estribo para extension.....	312	Busch tijera para cordon umbilical.....	64	cierranudos Eves.....	468
Böhler pinza cortante para huesos.....	241	Bushe cucharilla cortante.....	256	cierra-tubos Hoffmann.....	624
Böhler pinza gubia.....	238			cierra-tubos Simplex.....	624
Boies elevador.....	277			cincel.....	259-261, 264, 265
bomba de aire.....	295	C		cincel Alexander.....	259
bombilla de repuesto para laringoscopio.....	29, 30	caja para esterilizacion.....	616, 618	cincel Brunetti.....	268
Bonaccolto pinza para estrabismo.....	385	cajas para instrumentos.....	617	cincel Canfield.....	466
Bonn pinza para sutura.....	386	cailbrador decimal Iwanson.....	624	canula Air Injection.....	394
Bonney pinza de diseccion.....	88	calibre.....	26	canula capsular Jensen.....	394
Bose gancho para traqueotomia.....	477	calibre TOWNLEY.....	26	canula de aspiracion rectal Buie.....	566
Bose separador traqueal.....	476	Canfield bisturi para amigdalas.....	466	canula de aspiracion para mango de Zöllner y Wullstein.....	337/1
Boucheron especulo auricular.....	399	canula Air Injection.....	394	canula de inyeccion KLEINSASSER.....	36
Bowman aguja de discision.....	374	canula de aspiracion rectal Buie.....	566	canula de irrigacion y aspiracion Bishop-Harmon.....	394/1
Bowman blefarostato.....	374	canula de aspiracion para mango de Zöllner y Wullstein.....	337/1	canula de puncion Lichtwitz.....	433
Bowman cuchillo para discision.....	372	canula de inyeccion KLEINSASSER.....	36	canula de succion Baron.....	336
Bowman sonda lacrimal.....	381	canula de irrigacion y aspiracion Bishop-Harmon.....	394/1	canula de succion KLEINSASSER.....	36
Boynton porta aguja.....	214	canula de puncion Lichtwitz.....	433	canula Hartmann.....	433
Boys-Allis pinza intestinal.....	538	canula de succion Baron.....	336		
Bozemann pinza porta esponja.....	138	canula de succion KLEINSASSER.....	36		
Bozemann porta aguja.....	211	canula Hartmann.....	433		

cincel nasal West.....	442/1	Cooley pinza para anastomosis.....	519, 520	cucharilla cortante Jacobson.....	257
cincel para cuerpos extraños Dix.....	374	Cooley pinza para cateter.....	510	cucharilla cortante Jansen.....	257
cincel para el tabique nasal Freer.....	439	Cooley pinza vascular.....	520	cucharilla cortante Lempert.....	256
cincel para extirpacion Rollet.....	374	Cooley pinza vascular de uso multiple.....	518-520	cucharilla cortante Martini.....	257
cincel Partsch.....	259	Cooley pinza vascular pediatrica.....	522	cucharilla cortante REDA.....	256
cincel rompe-cranio.....	267	Cooley separador.....	148	cucharilla cortante Schede.....	251
cincel Smith-Petersen.....	261	Cooley separador costal.....	485, 487	cucharilla cortante Scoville.....	253
cincel Stille.....	260	COOLEY tubo de aspiracion.....	28	cucharilla cortante Spinal.....	253
cincel tamponador para huesos Passow.....	260	Cooley-Derra pinza para anastomosis.....	519	cucharilla cortante Spratt.....	251
Cinelli cincel nasal.....	441	Cooper aguja para ligadura.....	219	cucharilla cortante Volkmann.....	251, 257
Circumflex micro tijera.....	76	copas graduadas.....	620	cucharilla cortante Williger.....	255, 257
Citelli pinza sacabocado.....	430	Cordes punta de pinza.....	472	cucharilla para aborto Cuzzi.....	606
cizalla para yesos Stille.....	229	Coronal Blow Lift separador.....	198	cucharilla para aborto Wallich.....	607
clamp atrauma Bulldog.....	100	Corwin-Hegar pinza para torcer hilo.....	319	cucharilla para cataratas Daviel.....	377
clamp atrauma Bulldog DeBaKey.....	100, 103	Coryllos (Thorax) separador.....	166	cucharilla para cataratas Graefe.....	377
clamp atrauma Bulldog Glover.....	100, 103	Coryllos costotomo.....	480	cucharilla para cataratas Knapp.....	378
clamp Bulldog de Titanio.....	102	Cos pinza auricular micro.....	414	cucharilla para chalazion Axenfeld.....	377
clamp Bulldog DeBaKey-Dietrich.....	101	costotomo.....	480, 481	cucharilla para chalazion Hebra.....	377
clamp Bulldog Dietrich.....	101	costotomo bethune.....	481	cucharilla para chalazion Meyhoefer.....	377
clamp umbilical Collin.....	605	costotomo Brunner.....	481	cucharilla para exenteracion Bunge.....	378
clamp umbilical Kane.....	605	costotomo Coryllos.....	480	cucharilla uterina Simon.....	594
CLAR lampara frontal.....	22	costotomo Giertz-Stille.....	481	cucharra para sangre.....	268, 621
Clark blefarostato.....	370	costotomo Gluck.....	480	cuchillo auricular Politzer.....	408
Claus aguja para sutura del paladar.....	466	costotomo Sauerbruch.....	481	cuchillo auricular Sexton.....	408
Claus-Eicken aguja para sutura del paladar.....	466	costotomo Sauerbruch-Frey.....	481	cuchillo corneal Eilschnig.....	373
Clayman gancho.....	376	costotomo Stille.....	480	cuchillo corneal Gill.....	373
Cleveland pinza gubia.....	235	Cottle (Maltz) lima nasal.....	444	cuchillo corneal Sato.....	373
clip para esterilizacion Bunt.....	227, 624	Cottle cincel nasal.....	440	cuchillo corneal Took.....	373
clip para esterilizacion Mayo.....	227, 624	Cottle cuchillo rinoplastico.....	435	cuchillo de discision Berens.....	372
clips para aneurisma Yasargil.....	345-356	Cottle elevador para el tabique nasal.....	439	cuchillo de discision Jaeger.....	372
clips para vasos de Müller.....	365	Cottle especulo nasal.....	423	cuchillo de hoz REDA.....	435
Cloward pinza cortante para laminectomia.....	342	Cottle gancho para la piel.....	448	cuchillo interoseo.....	44
Cloward separador.....	178	Cottle Joseph elevador para el tabique nasal.....	439	cuchillo para amigdales Carpenter.....	465
Cloward separador para cuerpo vertebral.....	339	Cottle martillo.....	273	cuchillo para amputacion CATLIN.....	44
Cloward separador para tejido cervical.....	339	Cottle pinza para columna.....	448	cuchillo para amputacion LANGENBECK.....	44
coagulacion bipolar.....	630-633	Cottle pinza para fijacion.....	410	cuchillo para amputacion LISTON.....	44
Coakley cureta para seno.....	449	Cottle retractor nasal.....	447, 447/1	cuchillo para amputacion REDA.....	44
Coakley trocar para seno maxilar.....	204	COTTLE tijera nasal.....	59	cuchillo para autopsia.....	48
COBB cureta.....	252	COTTLE tijera para cirugia.....	56	cuchillo para autopsia VIRCHOW.....	48
Cobb gubia.....	262	Cottle-Kazanjian pinza cortante para huesos.....	241	cuchillo para cataratas Deutschmann.....	371
Cobb periostotomo.....	280	Cottle-Neivert gancho para la piel.....	448	cuchillo para cataratas Graefe.....	371
Cocciough pinza sacabocado para discos intervertebral.....	344/1	Coxeter cateter.....	555	cuchillo para cerebro VIRCHOW.....	48
Colibri (Barraquer) blefarostato.....	370	Crafoord pinza hemostatica.....	118	cuchillo para discision Wheeler.....	373
Colibri Barraquer tijera para oftalmologia.....	75	Crafoord tijera pulmonares.....	65/2	cuchillo para discision Bowman.....	372
Colibri pinza para iris.....	384	Crafoord-Sellors pinza hemostatica.....	119	cuchillo para discision Castroviejo.....	372
Collier-Crile pinza hemostatica.....	106	cranioclasto Braun.....	607	cuchillo para discision Graefe.....	372
Collier pelvimetro.....	605	cranioclasto Tarnier.....	607	cuchillo para discision Ziegler.....	373
Collier porta aguja.....	208	Crego elevador.....	282	cuchillo para falanges.....	44
Collin clamp umbilical.....	605	Crile gancho para nervio.....	328	cuchillo para goniotomia Barkan.....	373
COLLIN dinamómetro.....	25	Crile pinza hemostatica.....	107	cuchillo para goniotomia Scheie.....	373
Collin especulo vaginal.....	570	Crile porta aguja.....	213	cuchillo para iris Dean.....	372
Collin histero metro.....	586	Crile separador.....	140	cuchillo para iris Knapp.....	372
Collin Loktite separador abdominal.....	191	Crile-Murray porta aguja.....	209	cuchillo para iris Ziegler.....	372
COLLIN mango de bisturi.....	40	Crile-Rankin pinza hemostatica.....	107	cuchillo para organos.....	48
Collin martillo.....	270	Crile-Wood porta aguja.....	209	cuchillo para peristio.....	47
Collin pelvimetro.....	605	Critchett blefarostato.....	370	cuchillo para queratoplastica Barraquer.....	373
Collin pinza hemostatica.....	110	Crutchfield perforador inicial.....	327	cuchillo para queratoplastica Paufigue.....	373
Collin pinza para coger el utero.....	585	Crutchfield pinza de traccion craneal.....	327	cuchillo para reseccion.....	47
Collin pinza para quitar agrafes.....	224	cupeta para placenta.....	621	cuchillo para reseccion LANGENBECK.....	47
Collin pinza para tejido.....	539	cupeta Petri.....	620	cuchillo para tabique nasal Ballenger.....	436
Collin pinza porta esponja.....	137	cupetas.....	619	cuchillo para tabique nasal Freer.....	434
Collin pinza tira-lengua.....	453	cuchara medicinal.....	268	cuchillo para vegetaciones adenoides Barnhill.....	450
Collin separador.....	139	cuchara para calculos biliares Desjardins.....	534	cuchillo para vegetaciones adenoides Beckmann.....	450
Collin separador abdominal.....	190	cuchara para calculos biliares Fergusson.....	533	cuchillo para vegetaciones adenoides St.Clair-Thomson.....	450
Collin-Duval pinza de diseccion.....	85	cuchara para calculos biliares Luer-Koerte.....	533	cuchillo para vendaje enyesado Esmarch.....	233
Collin-Hartmann separador.....	141	cuchara para calculos biliares Mayo.....	534	cuchillo para vendaje enyesado Hopkins.....	233
Colver pinza para coger amigdalas.....	467	cuchara para calculos biliares Moor.....	532	cuchillo para vendaje enyesado Reiner.....	233
compas marcador Castroviejo.....	380	cuchara y gancho Gross.....	409	cuchillo para vendajes enyesados Wigmore.....	229
Cone pinza sacabocado craneal.....	331	cucharilla cortante.....	251-257	cuchillo Plester.....	418
Connin-Amsler marcador.....	380	cucharilla cortante Bruns.....	251, 254	cuchillo rinoplastico Converse.....	435
Converse cuchillo rinoplastico.....	435	cucharilla cortante Bushe.....	256	cuchillo rinoplastico Cottle.....	435
Converse separador.....	448	cucharilla cortante Daubenspeck.....	255	cuchillo Rosen.....	418
Cooley dilatador de aorta.....	528	cucharilla cortante Halle.....	253	cuchillo Schukhnecht.....	418

cuchillo Tabb	418	DeBaKey pinza vascular de uso multiple	495, 507, 508, 514, 515	Dingman elevador	463/3
cuchillo Wullstein	418	DeBaKey pinza vascular pediátrica	516, 517	Dingman periostotomo	463
Culler espátula para iris	378	DeBaKey pinzas traumáticas	98, 99	Dingmann abre-boca	456
cureta Antrum	435	DeBaKey porta aguja	210	Dingmann pinza para hueso	246
cureta aspiradora	600	DeBaKey separador	189/1	DIPLOMAT esfigmomanómetro	5
cureta aspiradora para biopsia uterina Novak	587	DeBaKey tijera	60	disecador corneal Green	374
cureta aspiradora para biopsia uterina Randall	587	DeBaKey tijera vascular	61	disecador corneal Paton	373
cureta Buck	407	DeBaKey-Bahson pinza para aneurisma	506	disecador para el saco lacrimal Lang	378
cureta Cobb	252	DeBaKey-Dietrich clamp Bulldog	101	disecador vascular Robb	530
cureta Faulkner	449	DeBaKey-Mosquito pinza hemostática	509	disecador Watson-Cheyne	199
cureta House	420	DeBaKey-Pean pinza hemostática traumática	513	disector Fisch	420
cureta para aborto Pestalozza	606	DeBaKey-Rankin pinza hemostática traumática	512	disector Gorney	277
cureta para biopsia Heany	587	DeBaKey-Satinsky pinza para oclusión tangencial	502	dispensador de cepillos	611
cureta para biopsia Kevorkian	587	DeBaKey-Semb pinza para ligadura y la aorta	499	dispensador para brocas filiformes	310
cureta para biopsia Mod. Muenchen	587	dedal	311	Dittel buja dilatadora	554
cureta para cuerpos extraños Alvis	374	DEJERINE martillo de percusión	24	Dix cincel para cuerpos extraños	374
cureta para hipofisis	334	Delee espejo vaginal	574	Dix instrumento para cuerpo extraños (doble)	380
cureta para hipofisis RAY	334	DeMartel guía conductora	330	Doren pinza para biopsia	588
cureta para lupus Fox	608	Demel aguja pasa-hilo	315	Doughty baja-lengua	458
cureta para lupus Piffard	608	Demel tensor de cierra-hilo	315	Douglas bisturi para amígdalas	466
cureta para seno Coakley	449	Denhart abre-boca	454	Douglas pinza depiladora	395
curetadas uterinas Blake	595	Denis-Browne separador abdominal	185	Douglas trocar	204
curetadas uterinas Bumm	597	depressor para epiglotis Reichert	471	Doyen espejo vaginal	574
curetadas uterinas Gourdet	599	depressor uterino Braun	586	Doyen estilete acanalado	199
curetadas uterinas Recamier	597	depressor uterino Sims	586	Doyen periostotomo	278
curetadas uterinas Schröder	595	DERF porta aguja	208	Doyen pinza de campo	133
curetadas uterinas Sims	597	dermatomo HUMBLY	50	Doyen pinza intestinal	540
curetadas uterinas Thomas	599	dermatomo SCHINK	49	Doyen pinza para polipos uterinos	585
Cusco espejo vaginal	570	dermatomo SILVER	50	Doyen separador	163
Cushing espátula cerebral	369, 369	dermatomo WATSON	50	Doyen separador abdominal	189/1
Cushing gancho para nervio	328	Derra pinza para anastomosis	515	Doyen tijera ginecológica	63
Cushing pinza cortante para laminectomía	340	D'Errico separador para la raíz de nervios	329/2	Doyen tirabuzón para fibroma	594
Cushing pinza de disección	83	Deschamps aguja para ligadura	218	Doyen-Baby pinza intestinal	540
Cushing separador	151, 152, 153	Desjardins cuchara para calculos biliares	534	Doyen-Jansen (Molt) abre-boca	454
Cushing-Taylor pinza de disección	87	Desjardins explorador para calculos biliares	532	Doyen-Stille separador	167
Cuzzi cucharilla para aborto	606	Desjardins pinza hemostática	121	Dubois tijera ginecológica	63
Czerny espejo rectal	559	Desjardins pinza para calculos biliares	531	Duehrsen pinza de disección	84
Czerny pinza uterina	584	Desmarres pinza para chalazión	393	Duplay pinza porta-esponja	134
D		Desmarres separador	151	Duplay pinza uterina	582
Dandy gancho para nervio	328	desobitador de vena	202	DUPLIX estetoscopio	23
Dandy pinza hemostática	109	destornillador Lane	323, 324	Dupuy-Weiss aguja para sutura amígdalas	466
Darling separador	178	destornillador Williams	323	Durante pinza de disección	88
Dartigue pinza para el útero	585	Deutschmann cuchillo para cataratas	371	Duval pinza de disección	85
Dastoor pinza para estrabismo	386	Devilbiss pinza sacabocado craneal	332	Duval pinza para tejido	539
Daubenspeck cucharilla cortante	255	diapason Hartmann	403	E	
Davidson (Scapula) separador	166	diapason REDA	403	Echlin pinza gubia	240
Daviel cucharilla para cataratas	377	diapason Lucae	404	ECO "T" y "C" estuche de diagnóstico	16
Davis aguja para cuerpos extraños	374	diapason Rydel-Seiffert	404	Eicken (Killian) canula irrigación	433
Davis elevador para duramadre	332	diaposones	403, 404	electrocirugía	628, 629
Davis espátula cerebral	337	Dieffenbach serra-fina	104	elevador	281-281
Davis pinza para esterilización de jeringas	227	Dieter pinza auricular micro	414	elevador Adson	282
Davis-Boyle abre-boca	455	Dietrich clamp Bulldog	101	elevador Alderdyce	282
Davis-Meyer abre-boca	457	Dietrich pinza para la aorta	510	elevador auricular Zaufal	409
Day gancho auricular	409	DIETRICH tijera vascular	60	elevador auricular Zaufal-Jansen	409
De Boer separador costal	486	dilatador de aorta Cooley	528	elevador Bennett	283
De Lee forceps obstetrico	602	dilatador de aorta Tubbs	528	elevador Blount	288
De Martel-Wolfson pinza para anastomosis	546	dilatador lacrimal Castroviejo	381	elevador Boies	277
De Martel-Wolfson pinza para cerrar clips	546	dilatador lacrimal Wilder	381	elevador Bristow	290
De Martel-Wolfson pinza para cerrar clips	546	dilatador lacrimal Ziegler	381	elevador Buck-gramcko	285
Dean cuchillo para iris	372	dilatador para conductos biliares Bakes	532	elevador Chandler	282
DEAN tijera para amígdalas	59	dilatador para el seno Ritter-Halle	433	elevador Crego	282
DEAVER separador	145, 146	dilatador para el seno Siebenmann	433/1	elevador Dingman	463/3
DEAVER tijera de disección	52	dilatador traqueal Laborde	476	elevador Hohmann	284, 285
DEAVER-GRIP separador	146	dilatador traqueal Trousseau-Baby	476	elevador Hohmann mini	286
DeBaKey clamp trauma Bulldog	100, 103	dilatador uterino Goodell	581	elevador Key	282
DeBaKey dilatador vascular	529	dilatador uterino Hank	580	elevador König	284
DeBaKey pinza para anastomosis	505, 515	dilatador uterino Hegar	578, 579	elevador Lane	290
DeBaKey pinza para aneurisma de la aorta	496, 497, 498	dilatador uterino Pratt	580	elevador Lane Trethowan	290
DeBaKey pinza para ligadura	493	dilatador uterino Sims	581	elevador Lange-Hohmann	286
DeBaKey pinza para ligadura	499, 500	dilatador uterino Wylie	581	elevador Lempert	420
DeBaKey pinza para vasos periféricos	494	dilatador vascular DeBaKey	529	elevador Mc Donald	283
		dinamómetro COLLIN	25	elevador Murphy-Lane	283

elevador Obwegeser	461	espatula cerebral Heifetz	369	estilete acanalado Doyen	199
elevador para amígdalas Henke	465	espatula cerebral Olivecrona	336	estilete hoja mirte	199
elevador para amígdalas Hurd	465	espatula Locke	612/1	estribo para extension Böhler	312
elevador para amígdalas Lopez-Reinke	465	espatula para ciclodialisis Bangerter	379	estribo para extension Kirschner	312
elevador para amígdalas Yankauer	465	espatula para ciclodialisis Castroviejo	379	estribo para extension Kirschner U.S.	312
elevador para cuerpos extraños Buck	412	espatula para ciclodialisis Elschmig	379	estuche de bolsillo y sutura	225
elevador para cuerpos extraños Quire	412	espatula para ciclodialisis Hirschman	379	estuche de diagnostico ECO "T" y ECO "C" ..	16
elevador para duramadre	332, 333	espatula para ciclodialisis Wheeler	379	estuche de diagnostico UNI I	13
elevador para duramadre Davis	332	espatula para enucleacion Wells	378	estuche de diagnostico UNI II	14
elevador para duramadre Frazier	333	espatula para iris Culler	378	estuche de diagnostico UNI III	15
elevador para duramadre Hoen	333	espatula para iris Wecker	378	estuche para autopsia	269
elevador para duramadre Horsley	333	espatula para la intima Robb	530	estuche para sutura Standard	226
elevador para duramadre Milligan	332	espatula pulmonar Allison	489	estuche para sutura y agrafes	225
elevador para duramadre Olivecrona	332	espatula vesical Kocher	552	estuche para traqueotomia	478
elevador para duramadre Penfield	333	espatula vesical Legueu	552	estuches de diagnostico RI-MINI	17
elevador para duramadre Sachs	332	espatulas abdominales	143, 143/1	estuches para esterilizar agujas	615
elevador para duramadre Toennis	332	especula vaginal Vu-More	569	Eves cierranudos	468
elevador para duramadre Woodson	333	especulo auricular Boucheron	399	EXACTA-SPEZIAL esfigmomanómetro	8
elevador para el tabique nasal Ballenger	439	especulo auricular Bruenings	401	explorador para calculos biliares Desjardins ..	532
elevador para el tabique nasal Cottle	439	especulo auricular Gruber	399	explorador para calculos biliares Moynihan ..	532
elevador para el tabique nasal Cottle Joseph ..	439	especulo auricular Hartmann	399	extractor Küntscher	322
elevador para el tabique nasal Freer	437	especulo auricular Politzer	399	extractor/impactor para clavos	321, 322
elevador para el tabique nasal Hajek-Ballenger ..	439	especulo auricular Richnau-Holmgren	400		
elevador para el tabique nasal Halle	437	especulo auricular Siegle	402	F	
elevador para el tabique nasal Howarth	438	especulo auricular Toynbee	399	face lift tijera Freeman	73
elevador para el tabique nasal Joseph	437	especulo endocervical Kogan	577	face lift tijera Gorney	73
elevador para el tabique nasal Killian	438, 439	especulo Friedmann	577	face lift tijera kaye	73
elevador para el tabique nasal McKenty	437, 438	especulo nasal Cottle	423	face lift tijera Peck Joseph	73
elevador para el tabique nasal Pennington	438	especulo nasal Hartmann	422	Face lift tijera Rees	73
elevador para el tabique nasal Pierce	438	especulo nasal Hartmann-Halle	421	Fansler protoscopio	564
elevador para el tabique nasal Roger	437	especulo nasal Killian	423	Farabeuf periototomo	274
elevador SAYRE	281	especulo nasal Mod. Vienna	421	Farabeuf pinza para hueso	243
elevador Verbrugge-Müller	286/2	especulo nasal REDA	423	Farabeuf separador	139
elevador Watson-Cheyne	283	especulo nasal Thudichum	421	Farabeuf-Collin periototomo	274
Elliot forceps obstetrico	602	especulo nasal Tieck-Halle	423	Farabeuf-Lambotte pinza para hueso	243
Ellis gubia para cuerpos extraños	374	especulo nasal Voltolini	421	Farrell porta-algodon	203
Elschnig cuchillo corneal	373	especulo rectal Alan-Parks	561	Faulkner cureta	449
Elschnig espatula para ciclodialisis	379	especulo rectal Barr	559	Faure pinza para biopsia	588
Elschnig pinza capsular	391	especulo rectal Bodenhammer	559	Faure pinza para peritoneo	123
Elschnig pinza para fijacion	389	especulo rectal Czerny	559	Favaloro tijera vascular	61
Emmet gancho para fistulas	594	especulo rectal Hill-Ferguson	560	Fehland pinza intestinal	542
Engel sierra para vendajes enyesados	229	especulo rectal Mathieu	560	Feilchenfeld pinza para espinas	91
ensordecedor Barany	405	especulo rectal Pratt	559	Feldheim pinza para huesos	249
ENUCLEATION tijera	58	especulo rectal Sawyer	560	Fergusson cuchara para calculos biliares	533
Epkér osteotomo	464/2	especulo rectal Schulze-Bergmann	560	Fergusson pinza hemostatica	109
Eppendorfer pinza para biopsia	590	especulo rectal Sims	559	Fergusson pinza para hueso	243
escariador	304	especulo vaginal	569-577	Fergusson tijera para intestino	66
escariador Perthes	304	especulo vaginal Auvard	576	Fergusson tubo de aspiracion	337
esclerotomo Guyton-Lundsgaard	373	especulo vaginal Breisky	577	Ferriera separador para cirugia plastica	197
esclerotomo Lundsgaard	373	especulo vaginal Collin	570	Ferris-Smith pinza cortante para laminectomia ..	343
escofina nasal Miller	444	especulo vaginal Collin	570	Ferris-Smith pinza de diseccion	85
escofina nasal Miller	444	especulo vaginal Cosco	571	Ferris-Smith-Kerrison pinza sacabocado para	
escofina nasal Peet	446	especulo vaginal Cosco	571	discos intervertebral	344, 344/2
escofina nasal Wiener	443	especulo vaginal Delee	574	Finocchio pinza bronquial	490
escupidora	621	especulo vaginal Doyen	574	Finocchio porta aguja	211
esfigmomanómetro BABYPHON	10	especulo vaginal Grave	570	Finocchio separador costal	482, 484
esfigmomanómetro EXACTA-SPEZIAL	8	especulo vaginal Jackson	573	Finocchio-Burford separador costal	483
esfigmomanómetro MINIMUS II	11	especulo vaginal Kallmorgen	573	Finsen separador	168
esfigmomanómetro MINIMUS III	12	especulo vaginal Kristeller	572	Fisch disector	420
esfigmomanómetro NOVA	7	especulo vaginal Landau	577	Fisch gancho para duramadre	335
esfigmomanómetro NOVA-PRESAMETER	6	especulo vaginal O'Sullivan-O'Connor	576	Fischer pinza para iris	384
esfigmomanómetro PRECISA	9	especulo vaginal Pederson	570	Fish sonda	199
esfigmomanómetro, DIPLOMAT	5	especulo vaginal Scherbak	575	Fisher bisturi para amígdalas	466
Esmarch cuchillo para vendaje enyesado	233	especulo vaginal Semm	571	Foerster pinza para iris	383
Esmarch tijera para vendaje	69/2	especulo vaginal Sims	573	Foerster porta esponjas	136
Esmarch vendaje de compresion	296	especulo vaginal Trelat	571	Fomon cincel nasal	441
espatula	203	espejo frontal ZIEGLER	21	Fomon gancho nasal	447/1
espatula abdominal Haberer	143/1	espejo laringeo	473	Fomon lima nasal	444, 445
espatula abdominal Kader	143/1	espejo laringeo Michel	423	Fomon periototomo	277
espatula abdominal Kümmel	144	estetoscopio ANESTOPHON	23	FOMON tijera nasal	58
espatula abdominal Ribbon	143	estetoscopio DUPLEX	23	Fomon tijera para rinoplastia	65/1
espatula cerebral Cushing	336, 369	estetoscopio PINARD	23	forceps obstetrico Barton	603
espatula cerebral Davis	337	estilete abotonado	199	forceps obstetrico Boerma	604
		estilete acanalado abotonado	199		

forceps obstetrico De Lee.....602	gancho para estrabismo Graefe.....375	Graefe pinza para iris.....382
forceps obstetrico Elliot.....602	gancho para estrabismo Jameson.....375	Graefequistotomo.....375
forceps obstetrico Kielland.....602	gancho para extraccion Arruga.....375	GRAEFFE tijera para cirugia.....56
forceps obstetrico Kielland-Luikart.....603	gancho para fistulas Emmet.....594	Graham gancho para nervio.....329
forceps obstetrico Luikart.....603	gancho para galea Yasargil.....330	Graig pinza para tabique nasal.....426
forceps obstetrico McLean.....603	gancho para iris O'Conner.....375	grapa para cuero cabelludo Raney.....327
forceps obstetrico McLean-Tucker.....603	gancho para iris Wiener.....375	grapas.....326
forceps obstetrico McLean-Tucker-Luikart.....603	gancho para la piel Cottle.....448	Grave especulo vaginal.....570
forceps obstetrico Naegele.....602	gancho para la piel Cottle-Neivert.....448	Gray pinza hemostatica.....121
forceps obstetrico Piper.....604	gancho para la piel Freer.....448	Green disecador corneal.....374
forceps obstetrico Simpson.....602	gancho para la piel Gillies.....448	Green gancho muscular.....375
forceps obstetrico Simpson-Braun.....602	gancho para las alas de la nariz Lange.....448	Green pinza para fijacion.....390
forceps obstetrico Simpson-Luikart.....603	gancho para nervio Crile.....328	Green separador.....160
forceps obstetrico Tarnier.....604	gancho para nervio Cushing.....328	Green-Armytage pinza para uterus.....605
forceps obstetrico Wrigley.....602	gancho para nervio Dandy.....328	Gregory pinza atraumatica.....517
FOREGGER juego de laringoscopia.....31	gancho para nervio Graham.....329	Greven pinza auricular micro.....414
FOREGGER laringoscopia.....29	gancho para nervio Sachs.....329	Grip alicata.....316
Fox cureta para lupus.....608	gancho para nervio Smithwick.....329	Gross cuchara y gancho.....409
Fraenkel pinza para laringe.....471	gancho para nervios Kraysenbühl.....336	Gross-Maier pinza porta-esponja.....134
Fraenkel punta de pinza.....472	gancho para sacar el inserto I.U.D.....593	Gruber especulo auricular.....399
Francis aguja para cuerpos extraños.....374	gancho para traqueotomia Bose.....477	gubia.....259-265
Franklin-Silvermann aguja para biopsia.....206	gancho para traqueotomia Iterson.....477	gubia Alexander.....259
Frazier elevador para duramadre.....333	gancho para traqueotomia Jackson.....476	gubia Brünings-Lucas.....260
Frazier gancho.....149	gancho para traqueotomia News.....477	gubia Cobb.....262
Frazier separador abdominal.....181	gancho REDA.....150	gubia Hibbs.....265
Frazier/Fergusson tubo de aspiracion.....337	gancho Rollet.....375	gubia Lexer.....263
Freeman separador.....198	gancho Rosen.....419	gubia Lexer Mini.....263
Freeman tijera face lift.....73	gancho Shambaugh.....419	gubia para cuerpos extraños Ellis.....374
Freer cincel nasal.....442/1	gancho Sinskey.....376	gubia para cuerpos extraños Walton.....374
Freer cincel para el tabique nasal.....439	ganchos.....419	gubia Patsch.....259
Freer cuchillo para tabique nasal.....434	garrote de madera Maunder.....459	gubia Smith-Petersen.....261
Freer elevador para el tabique nasal.....437	Gass gancho.....376	gubia Stille.....260
Freer gancho para la piel.....448	Gauss pinza para pericraneio.....605	gubia Zielke.....264
FRENZEL anteojos para nistagmo.....20	Gelpi separador perineal.....189/1, 189/2	guia-conductor de Martel.....330
Frenzel baja-lengua.....451	Gemini pinza hemostatica.....115	guia-conductora para clavos medulares.....321
Friedmann especulo.....577	Gerald pinza de diseccion.....86, 87	Guilen legra de succion.....433/1
Friedmann mini pinza gubia.....234	Gerster barra de traccion.....250	Guthrie gancho.....149
Friedmann pinza gubia.....234	Gerzog martillo.....270	Guyon buja dilatadora.....554
Fritsch separador.....163	Giertz-Stille costotomo.....481	Guyon mandril para cateter.....554
Frykholm pinza gubia.....240	Gigli mango para sierra hilo.....332	Guyon pinza hemostatica.....122
Fuchs pinza capsular.....391	Gill cuchillo corneal.....373	Guyton-Lundsgaard esclerotomo.....373
Fuchsigs pinza hemostatica.....113	Gill pinza para iris.....384	
	Gill-Arruga pinza capsular.....390	
	Gill-Hess pinza para iris.....384	
	Gillies gancho para la piel.....448	
	Gillies pinza de diseccion.....86	
	Gillies porta aguja.....212	
	Gil-Vernet separador.....152	
	Glover clamp atrauma Bulldog.....100, 103	
	Glover pinza para uso multiple.....515	
	Gluck costotomo.....480	
	Goelet separador.....141	
	Goldman-Fox tijera para encias.....67	
	Gomel micro tijera.....80	
	Gomel pinza para microcirugia.....96	
	goniometro MOELTGEN.....25	
	goniometro para dedos.....25	
	GOOD tijera para amigdalas.....59	
	Goodell dilatador uterino.....581	
	Gorney disector.....277	
	Gorney tijera face lift.....73	
	Gosset separador abdominal.....181	
	Gourdet curetas uterinas.....599	
	Gradle pinza depiladora.....395	
	GRADLE tijera para oftalmologia.....57	
	Graefe blefarostato.....370	
	Graefe cucharilla para cataratas.....377	
	Graefe cuchillo para cataratas.....371	
	Graefe cuchillo para discision.....372	
	Graefe gancho.....149	
	Graefe gancho para estrabismo.....375	
	Graefe pinza de diseccion.....83	
	Graefe pinza para fijacion.....389	
G		
Gallaher lima para seno.....446		
gancho Guthrie.....149		
gancho Joseph.....149		
gancho Kleinert-Kutz.....149		
gancho Lahay.....149		
gancho nasal Fomon.....447/1		
gancho abotonado Lucae.....409		
gancho abotonado Wagener.....409		
gancho auricular Day.....409		
gancho Barbara.....419		
gancho Clayman.....376		
gancho cutaneo Kliner.....608		
gancho de decapitacion Braun.....607		
gancho de menton Obwegeser.....461		
gancho extractor.....322		
gancho Gass.....376		
gancho Kirschner.....313		
gancho Klapp.....150		
gancho Knapp.....375		
gancho McGee.....419		
gancho muscular.....267		
gancho muscular Green.....375		
gancho obstetrico Smellie.....605		
gancho para cristalino Stevens.....375		
gancho para duramadre.....335		
gancho para dura-madre Adson.....329		
gancho para duramadre Fisch.....335		
		H
		Haberer espátula abdominal.....143/1
		Haglund-Stille separador para yesos.....232
		Haight separador costal.....487
		Hajek cincel nasal.....442/1
		Hajek martillo.....273
		Hajek-Ballenger elevador para el tabique nasal.....439
		Hajek-Kofler pinza cortante.....429
		Hajek-Kofler pinza sacabocado.....431
		Halle cucharilla cortante.....253
		Halle elevador para el tabique nasal.....437
		Halsey porta aguja.....208
		Halsted-Mosquito pinza hemostatica.....105
		Hank dilatador uterino.....580
		Hargis separador para el borde anterior.....463
		Hargis separador para el cuerpo mandibular.....463/6
		Harken pinza auricular.....503
		Harms sonda.....381
		Harrington pinza bronquial.....490
		Harrington separador.....147
		Harrington-Pemberton separador.....147
		Hartmann baja-lengua.....452
		Hartmann canula.....433
		Hartmann cateter auricular.....408
		Hartmann diapason.....403
		Hartmann especulo auricular.....399
		Hartmann especulo nasal.....422
		Hartmann pinza auricular.....411
		Hartmann pinza hemostatica.....104
		Hartmann pinza nasal.....424, 427
		Hartmann pinza para polipos.....412

Hartmann-Halle especulo nasal.....	421	Huber mango universal.....	472	Joseph sierra nasal.....	446
Hartmann-Hoffmann pinza para polipos.....	412	Hudson perforador de mano.....	299	JOSEPH tijera para cirugia.....	54
Hartmann-Wullstein pinza para polipos.....	412	Hulka pinza uterina.....	583	Judd-Allis pinza intestinal.....	538
Haugh pinza auricular micro.....	414	HUMBY dermatomo.....	50	Judd-Masson separador vesical.....	552
Hayes pinza para anastomosis del recto.....	545	Hunter pinza para espinas.....	91	juego de laringoscopia FOREGGER.....	31
Heaney pinza para histerectomia.....	126	Hurd elevador para amigdales.....	465	juego de laringoscopia McINTOSH.....	31
Heaney porta aguja.....	210	I.....		juego de manicura para enfermeras.....	609
Heaney separador.....	164	I.U.D. gancho para sacar el inserto.....	593	juego para varices NABATOFF.....	201
Heany cureta para biopsia.....	587	iman ocular REDA.....	395	Juers pinza auricular micro.....	414
Heany-Ballentine pinza para histerectomia.....	127	impactor final Kuentscher.....	321	Jurasz pinza para polipos laringeos.....	471
Heath martillo.....	273	impactor/extractor para clavos.....	321, 322	K.....	
Heath tijera para ligadura.....	66	Inge separador para cuerpo vertebral.....	339	Kabierske lanzapolvo.....	405
Hebra cucharilla para chalazion.....	377	Instru Care aceite para instrumentos.....	634	Kader espátula abdominal.....	143/1
Hegar dilatador uterino.....	578, 579	instrumento para circuncision.....	556	Kallmorgen especulo vaginal.....	573
Hegebarth pinza para aplicar agrafes.....	224	instrumento para circuncision Mogen.....	556	Kalt pinza capsular.....	391
Heifetz espátula cerebral.....	369	instrumento para cuerpo extraños (doble) Dix.....	380	Kalt porta aguja.....	214
Heiming pinza para calculos renales.....	536	instrumento para cuerpos extraños La Force.....	374	Kalt-Arruga porta aguja.....	214
Heiss pinza hemostatica.....	112	instrumento para el fragmento de la uña.....	612/1	Kane clamp umbilical.....	605
Heister abre-boca.....	454	instrumento para varices Varady.....	202	Kantowitz pinza hemostatica.....	119/1
hemostatico.....	258, 259	instrumento para vendaje enyesado REDA.....	232	Kaye tijera face lift.....	73
hemostatico Caspar.....	258	instrumentos para manicura.....	612, 612/1	Kelly Grip separador.....	142
Henke elevador para amigdales.....	465	instrumentos para medir.....	594	Kelly pinza hemostatica.....	106
Henley separador.....	170	instrumentos para traqueotomia.....	475	Kelly pinza para polipos uterinos.....	585
Hennig separador para yesos.....	232	Iowa pinza uterina.....	584	Kelly protoscopio.....	562, 563
Hepp-Scheidel micro tijera.....	78	IRIS tijera para cirugia.....	54	Kelly separador.....	142, 164
Herrick pinza para pediculo.....	123	Iris tijera supercut.....	72	Kelly tijera vascular.....	61
Hess pinza capsular.....	391	Israel separador.....	162	Kelly-Rankin pinza hemostatica.....	106
Hess pinza para iris.....	384	Ibson gancho para traqueotomia.....	477	Kern pinza para hueso.....	244
Hess separador para la raiz de nervios.....	329/1	Ives-Fansler anoscopio.....	562	Kerrison pinza cortante.....	428
Heymann pinza nasal.....	425	Iwanson calibrador decimal.....	624	Kevorkian cureta para biopsia.....	587
HEYMANN tijera nasal.....	58	J.....		Kevorkian pinza para biopsia.....	589, 591
Heymann-Knight pinza nasal.....	425	Jackson especulo vaginal.....	573	Kevorkian-Pacific pinza para biopsia.....	592
Heywood-Smith pinza hemorroidal.....	567	Jackson gancho para traqueotomia.....	476	Key elevador.....	282
Hibbs cincel.....	265	JACKSON laringoscopia.....	37	Keyes trepano.....	608
Hibbs gubia.....	265	Jackson pinza de agarre para tendones.....	292	Kieiland forceps obstetrico.....	602
Hibbs osteotomo.....	265	Jackson pinza para taponos.....	471	Kieiland-Luikart forceps obstetrico.....	603
Hibbs separador.....	164	JACKSON portador de luz.....	37	Killian (Eicken) canula irrigacion.....	433
Hill-Ferguson especulo rectal.....	560	Jackson separador traqueal.....	476	Killian canula.....	433/1
hilos para huesos.....	314	Jackson-Burrows separador.....	189/2	Killian cincel nasal.....	442/1
Hirschman espátula para ciclodialis... ..	379	Jacobs pinza uterina.....	583	Killian elevador para el tabique nasal.....	438, 439
Hirschmann anoscopio.....	562	Jacobsen porta aguja.....	215	Killian especulo nasal.....	423
histerometro Collin.....	586	Jacobson porta aguja.....	257	Killian tijera para septo.....	471
histerometro Martin.....	586	Jacobson cucharilla cortante.....	257	Killian-Claus cincel nasal.....	442/1
histerometro Sims.....	586	Jacobson sonda abotonada.....	335	Kilner gancho cutaneo.....	608
histerometro Valleix.....	586	Jaeger cuchillo de discision.....	372	Kilner porta aguja.....	212
Hoen elevador para duramadre.....	333	Jaeger placa para parpado.....	371	Kilner retractor nasal.....	447/1
Hoesel porta aguja.....	213	Jameson gancho para estrabismo.....	375	KILNER tijera para cirugia.....	54
Hofer separador para pilar.....	465	Jansen pinza para estrabismo.....	385	Kilner/Ragnell tijera supercut.....	72
Hofmann cierra-tubos.....	624	Jansen cucharilla cortante.....	257	Kilner-Doughty abre-boca.....	456
Hohmann elevador.....	284, 285	Jansen pinza gubia.....	237	Kirby-Arthur pinza para fijacion.....	385
Hohmann mini elevador.....	286	Jansen pinza nasal.....	424	Kirk martillo.....	270
hoja de repuesto para dermatomo.....	49	Jansen separador.....	168	Kirschner alambre.....	306, 307
hoja de repuesto para dermatomo.....	50	Jansen-Gruenwald pinza nasal.....	424	Kirschner estribo para extension.....	312
hojas de afeitar.....	45	Jarcho pinza uterina.....	583	Kirschner gancho.....	313
hojas de bisturi, esteril.....	42	Javid pinza para shunt carotido.....	511	Kirschner perforador de mano.....	299
hojas de bisturi, esteril, desechables.....	43	Jennings abre-boca.....	454	Kirschner separador abdominal.....	185, 187, 187/1
hojas de cincel intercambiables.....	266	Jensen canula capsular.....	394	Kirschner sonda conductora.....	221
hojas de osteotomo intercambiables.....	266	jeringa.....	406, 407	Kirschner soporte de esterilizacion para alambres.....	305
Hoke osteotomo.....	265	jeringa auricular Reiner.....	406	Kirschner U.S. estribo para extension.....	312
HOLINGER laringoscopia.....	37	jeringa para amigdales.....	470	Klapp gancho.....	150
HOLINGER portador de luz.....	37	Jobson-Horne porta-algodon.....	203	Kleinert-Kutz ganchito.....	149
Holsher separador para la raiz de nervios.....	329/1	Johns-Hopkins pinza hemostatica.....	120	Kleinert-Kutz pinza de agarre para tendones.....	294
Holth pinza para capsuloidectom.....	380	Johns-Hopkins serra-fina.....	104	Kleinert-Kutz pinza gubia.....	237
Holzbach pinza para histerectomia.....	126	Jones pinza de campo.....	132	KLEINSASSER anillo.....	36
Holzheimer separador.....	168	Jones-Clip pinza de campo.....	132	KLEINSASSER articulacion.....	36
Hopkins cuchillo para vendaje enyesado.....	233	Jonson porta aguja.....	211	KLEINSASSER canula de inyeccion.....	36
horquilla fijadora Burch.....	373	JORGENSEN tijera de diseccion.....	53	KLEINSASSER canula de succion.....	36
Horsley elevador para duramadre.....	333	Joseph bisturi nasal.....	434, 435	KLEINSASSER laringoscopia operativo.....	35
Hösel separador.....	167	Joseph elevador para el tabique nasal.....	437	KLEINSASSER portadore de luz fria.....	36
House cureta.....	420	Joseph ganchito.....	149	KLEINSASSER soporte pectoral.....	36
House sonda para mesurar.....	420	Joseph lima para hueso.....	443	Klein Schmidt pinza para apendice.....	544
House tubo de aspiracion.....	337/2	Joseph periostotomo.....	277	Klinikum Berlin pinza cierra-tubo.....	129
Howarth elevador para el tabique nasal.....	438				

Klinkenbergh-Loth tijera vasija.....	65/2	Lang diseccador para el saco lacrimal.....	378	Littauer pinza depiladora.....	395
Knapp cucharilla para cataratas.....	378	Lange gancho para las alas de la nariz.....	448	Littauer pinza para polipos.....	425
Knapp cuchillo para iris.....	372	Lange punta de pinza.....	472	Littauer tijera para ligadura.....	66
Knapp gancho.....	375	Langè-Hohmann elevador.....	286	Little separador.....	157
KNAPP tijera para cirugia.....	55	Langenbeck asa.....	409	LITTLE tijera para cirugia.....	55
Knapp-Luer pinza para tracomia.....	393	LANGENBECK cuchillo para amputacion.....	44	Littlewood pinza intestinal.....	538
Knight pinza nasal.....	425	LANGENBECK cuchillo para reseccion.....	47	lave de tuerca.....	313
Knowles tijera para vendaje.....	70	Langenbeck periostotomo.....	275	Locke espátula.....	612/1
Kocher espátula vesical.....	552	Langenbeck pinza para hueso.....	243	Lockhart-Mummary sonda para fistula.....	200
Kocher pinza hemostatica.....	108	Langenbeck porta aguja.....	213	Locklin tijera para encias.....	69
Kocher pinza intestinal.....	540	Langenbeck separador.....	158, 159	Lockwood-Allis pinza intestinal.....	538
Kocher separador.....	155	Langenbeck sierra para amputacion.....	296	London-College pinza dental.....	93
Kocher separador.....	159, 160, 163	Langenbeck-Green separador.....	153	Lopez-Reinke elevador para amigdales.....	465
Kocher sonda para bocio.....	479	lanzapolo Kabierske.....	405	Lorenz tijera para vendaje.....	70
Kocher-Langenbeck separador.....	159	laringoscopio FOREGGER.....	29	Lorna pinza para campo.....	133
Koenig sonda conductora.....	221	laringoscopio HOLINGER.....	37	Loute tensor de cierra-hilo.....	315
Koerte separador.....	162	laringoscopio JACKSON.....	37	Love separador para la raiz de nervios.....	329/2, 330
Kogan especulo endocervical.....	577	laringoscopio McINTOSH.....	29	Love separador para uvula.....	465
König elevador.....	284	laringoscopio MILLER.....	30	Love-Gruenwald pinza cortante para laminectomia.....	340
König periostotomo.....	276	laringoscopio operativo KLEINSASSER.....	35	Lovelace pinza hemostatica.....	109
König separador.....	153	Larsen pinza para tendones.....	292	Lovelace pinza para coger el pulmon.....	490
Koos micro cuchillo.....	335	Lawrence pinza hemostatica.....	119	Lower pinza hemostatica.....	120
Körte separador.....	143/1	Lebsche cincel de esternon.....	267	Lowman pinza para huesos.....	249
Krause cierra-nudo auricular.....	411	Lees pinza bronquial.....	504	Lowman-Hoglund pinza para huesos.....	249
Krause polipotomo.....	433/2	legra corneal Kuhnt.....	373	Lubet-Barbon pinza nasal.....	424
Krause punta de pinza.....	472	legra de succion Guilen.....	433/1	Luc pinza nasal.....	426
Krause-Voss polipotomo.....	433/2	Legueu espátula vesical.....	552	Lucae aguja para paracentesis.....	408
Krayenbühl gancho para nervios.....	336	Legueu separador vesical.....	553	Lucae diapason.....	404
Kristeller especulo vaginal.....	572	Leksell (Stille) pinza gubia.....	240	Lucae gancho abotonado.....	409
Kroenig baja-lengua.....	451	Leland-Jones pinza para vasos perifericos.....	494	Lucae martillo.....	271
Kronecker aguja para ligadura.....	219	Lempert cucharilla cortante.....	256	Lucae pinza auricular.....	410
Kuentscher impactor final.....	321	Lempert elevador.....	420	Luer canula para traqueotomia.....	479
Kuglen manipulador.....	376	Lempert pinza gubia.....	237	Luer pinza gubia.....	236
Kühnt legra corneal.....	373	Lerche pinza de diseccion.....	83	Luer separador.....	140
Kümmel espátula abdominal.....	144	Leriche pinza hemostatica.....	111	Luer-Koerte cuchara para calculos biliares.....	533
Kümmel separador abdominal.....	143/2	Leriche separador intestinal.....	143/2	Luikart forceps obstetrico.....	603
Küntscher extractor.....	322	Lester pinza para fijacion.....	389	Luikart-Bill tractor.....	604
Küntscher perforador para femur.....	321	Levinson aguja para cuerpos extraños.....	374	Lundsgaard esclerotomo.....	373
Küntscher perforador para la cavidad medular.....	321	Lewin pinza para hueso.....	246	Luniatschek tamponador.....	465
		Lewis (Joseph) lima nasal.....	443		
		LEXER BABY tijera de diseccion.....	53		
L		Lexer gubia.....	263	M	
L&M separador intra oral.....	463/4	Lexer Mini gubia.....	263	MAGILL pinza para introducir cateter.....	28
La Force instrumento para cuerpos extraños.....	374	Lexer Mini osteotomo.....	263	malta de alambre.....	311
La Grange tijera para encias.....	69	Lexer osteotomo.....	263	Maltz lima nasal.....	443, 444
La Grange tijera supercut.....	72	LEXER tijera de diseccion.....	53	mandril.....	300
Laborde dilatador traqueal.....	476	Leyla separador de sistema.....	368-368/4	mandril para cateter Guyon.....	554
Lacrimal canula.....	394	lezna Obwegeser.....	463, 463/3	mango bisturi MINI.....	41
LaForce adenotomo.....	450	Lichtenberg porta aguja.....	213	mango bisturíes.....	38-41
Lahey gancho.....	149	Lichtwitz canula de puncion.....	433	mango con iluminacion para proctoscopia Morgan.....	565
Lahey pinza para agarrar el bocio.....	479	Lichtwitz trocar para seno maxilar.....	204	mango de aspiracion Wullstein.....	338
LAHEY pinzas hemostáticas.....	119/2, 120	Liebermann blearostato.....	371	mango de bisturi COLLIN.....	40
Lahey separador.....	157	ligador para hemorroides.....	568	mango de pila para laringoscopia.....	32, 33, 34
Lambert pinza para chalazion.....	393	ligador para hemorroides McGivney.....	568	mango para cincel/gubia.....	266
Lambert-Kay pinza para anastomosis.....	505	ligador para hemorroides Rudd.....	568	mango para espejo laringeo.....	473
Lambert-Lowman pinza para huesos.....	249	lima nasal Aufrecht.....	443	mango para sierra hilo Gigli.....	332
Lambotte osteotomo.....	261	lima nasal Cottle (Maltz).....	444	mango universal Huber.....	472
Lambotte periostotomo.....	274	lima nasal Fomon.....	444, 445	manos de acople rapido.....	301
Lambotte pinza para hueso.....	244	lima nasal Lewis (Joseph).....	443	manguito de cierre Stone-Watt.....	545
lampara frontal CLAR.....	22	lima nasal Maltz.....	443, 444	manipulador Kuglen.....	376
lampara halogena.....	29	lima para hueso Joseph.....	443	manometro.....	295
Lancaster blearostato.....	371	lima para huesos.....	294	manopla de plomo.....	250
Landau especulo vaginal.....	577	lima para huesos.....	612/1	marcador Connin-Amsler.....	380
Landolt pinza para tumores.....	341	lima para huesos Putti.....	294	Marquardt pinza gubia.....	239
Lane destornillador.....	323, 324	lima para seno Gallaher.....	446	Marschik pinza para amigdales.....	468
Lane elevador.....	290	lima para uñas.....	610	Martel pinza hemostatica.....	110
Lane palanca para doblar placas.....	325	lima para esponja.....	137	martillo.....	270, 271, 272, 273
Lane pinza de campo.....	133	Lister (Sinus) pinza porta esponja.....	137	martillo Bergmann.....	272
Lane pinza de diseccion.....	84	Lister tijera para vendaje.....	69/1	martillo Collin.....	270
Lane pinza estomacal.....	547	Lister tijera supercut.....	72	martillo Cottle.....	273
Lane pinza para hueso.....	244	Lister-Burch blearostato.....	370	martillo de percusion BABINSKY.....	24
Lane pinza para sostener placas.....	325	LISTON cuchillo para amputacion.....	44	martillo de percusion BERLINER.....	24
Lane pinza para sostener tornillos.....	325	Liston pinza cortante para huesos.....	241	martillo de percusion BUCK.....	24
Lane Trethowan elevador.....	290	Littauer pinza auricular.....	411	martillo de percusion TAYLOR.....	24

martillo de percusion TROEMNER.....	24	Mellinger-Axenfeld blefarostato.....	370	Moynihan pinza de campo.....	133
martillo Gerzog.....	270	Menghini aguja para biopsia.....	206	Moynihan pinza hemostatica.....	120
martillo Hajek.....	273	meniscotomo Neff.....	292	Mueller blerlarostato.....	371
martillo Heath.....	273	meniscotomo Smillie.....	292	Muenchen Mod. cuerta para biopsia.....	587
martillo Kirk.....	270	Mercedes separador toracico.....	489	Müller aproximador.....	364
martillo Lucae.....	271	Meriam pinza dental.....	93	Müller clips para vasos.....	365
martillo Mead.....	271	Metzenbaum porta aguja.....	211	Murdoch blefarostato.....	370
martillo Ombredanne.....	273	METZENBAUm tijera de diseccion.....	53/1	Murphy separador.....	156
martillo Partsch.....	271	METZENBAUM tijera para cirugia.....	54	Murphy-Lane elevador.....	283
martillo Quisling.....	271	Metzenbaum tijera supercut.....	71	Museux pinza uterina.....	583
martillo Williger.....	271	Meyering separador.....	157, 177, 180	Myles pinza nasal.....	427
Martin histormetro.....	586	Meyhoefer cucharilla para chalazion.....	377		
Martin pelvimetro.....	605	Michel agrafe.....	224	N	
Martin pinza para cartilago.....	246	Michel espejo laringeo.....	423	NABATOFF juego para varices.....	201
Martin separador.....	175/1	Michel pinza para aplicar agrafes.....	224	Naegele forceps obstetrico.....	602
Martin-Cartilage tijera.....	65/1	Michel pinza para aplicar y quitar agrafes.....	224	Nager aguja para sutura del paladar.....	466
Martini cucharilla cortante.....	257	micro cuchillo Koos.....	335	Nager separador para paladar.....	465
Masing retractor nasal.....	447	Micro Friedmann pinza gubia.....	234	navaja.....	49
Masing-Neivert retractor nasal.....	447	micro pinza auricular.....	413, 414, 415	Neff meniscotomo.....	292
Masson porta aguja.....	210	micro pinzas.....	86, 94	Negus pinza para coger amigdalas.....	467
Maxtin pinza muscular.....	479	micro porta aguja Barraquer.....	216, 217	Negus soporte de pecho.....	459
Mathieu especulo rectal.....	560	micro porta aguja Barraquer-Trounman.....	216	Neivert porta aguja.....	208
Mathieu pinza para cuerpos extraños.....	553/1	micro porta aguja Castroviejo-Standard.....	216	Neivert-Anderson cincel nasal.....	442
Mathieu porta aguja.....	213	micro tijera Circumflex.....	76	Nelaton sonda.....	199
Mathieu separador.....	141	micro tijera Gommel.....	80	Nelson (Standard) trocar abdominal.....	204
Mathieu-Olsen porta aguja.....	212	micro tijera Hepp-Scheidel.....	78	Nelson aguja para ligadura.....	219
Matson periostotomo.....	279	micro tijeras.....	76, 77, 78	Nelson pinza de diseccion.....	89
Matson-Alexander periostotomo.....	279	micro tijeras REDA.....	77, 80	Nelson trocar.....	205
Maunder garrote de madera.....	459	Microvascular porta aguja.....	210	Neonatal pinza vascular.....	523
Maxi Grasper pinza para biopsia.....	593	Middeldorf separador.....	160	News gancho para traqueotomia.....	477
May oftalmoscopio UNI II.....	14	Middleton-Jansen pinza para tabique nasal.....	430	Nissen pinza hemostatica.....	113
Mayfield pinza gubia.....	238	Mikulicz pinza intestinal.....	543	Norfolk / Norwich separador.....	172
Mayo baja-lengua.....	451	Mikulicz pinza para peritoneo.....	123	Northbert tijera.....	66
Mayo clip para esterilizacion.....	227, 624	Mikulicz separador.....	163	Norwich / Norfolk separador.....	172
Mayo cuchara para calculos biliares.....	534	MILLER laringoscopio.....	30	Noto pinza para polipos uterinos.....	585
Mayo pinza de diseccion.....	89	Milligan elevador para duramadre.....	332	NOVA esfigmomanometro.....	7
Mayo sonda para calculos biliares.....	534	Millin pinza de agarre para capsula.....	550, 551	Novak cureta aspiradora para biopsia uterina.....	587
MAYO tijera de diseccion.....	52	Millin pinza para ligadura.....	551	NOVA-PRESAMETER esfigmomanometro.....	6
Mayo tijera supercut.....	71	Millin pinza para lobo anterior.....	551	Noyes pinza para polipos.....	425
Mayo-Adams separador.....	171	Millin separador cuello vejiga.....	553	Noyes tijera para iris.....	75
Mayo-Blake pinza para calculos biliares.....	531	Millin separador vesical.....	552		
Mayo-collins separador.....	141	MINI mango de bisturi.....	41	O	
Mayo-Guyon pinza hemostatica.....	122	Mini-Lamotte osteotomo.....	262	Obwegeser elevador.....	461
Mayo-Haberisser pinza para torcer hilo.....	319	MINIMUS II esfigmomanometro.....	11	Obwegeser gancho de menton.....	461
Mayo-Hegar porta aguja.....	209	MINIMUS III esfigmomanometro.....	12	Obwegeser lezna.....	463, 463/3
MAYO-NOBLE tijera de diseccion.....	52	Mini-Townsend-Down pinza para biopsia.....	591	Obwegeser osteotomo.....	463
Mayo-Robson pinza intestinal.....	541	Mini-Townsend-Up pinza para biopsia.....	591	Obwegeser osteotomo de hoja.....	464/1
MAYO-STILLE tijera de diseccion.....	52	Mixer Baby pinza hemostatica.....	119/1	Obwegeser periostotomo.....	462
Mayo-Stille tijera supercut.....	71	Mixer pinza hemostatica.....	116, 119/1, 119/2, 120	Obwegeser separador manibular.....	461
Mc Donald elevador.....	283	Mixer pinza para calculos biliares.....	531	Obwegeser separador para partes blandas.....	460
McCullough pinza para estrabismo.....	385	Mixer-O'Shaughnessy pinza hemostatica.....	119/2	Ochsner pinza de diseccion.....	88
McGee gancho.....	419	Mod. Bonn pinza para sutura.....	386	Ochsner trocar.....	205
McGee pinza auricular micro.....	414	Mod. Muenchen cureta para biopsia.....	587	O'Conner gancho para iris.....	375
McGivney ligador para hemorroides.....	568	Mod. Tübingen pinza para ligadura.....	392	Oehler pinza de diseccion.....	81/1
McGivney pinza para hemorroides.....	568	Mod. Tübingen pinza para sutura.....	386	oftalmoscopio May UNI II.....	14
McIndoe pinza cortante para huesos.....	241	Mod. USA tijera para cordon umbilical.....	64	Oldberg pinza cortante para laminectomia.....	341
McIndoe pinza de diseccion.....	85	Mod. Vienna especulo nasal.....	421	oliva auricular.....	406
McIndoe tijera para cartilago.....	65/1	MOELTGEN goniometro.....	25	oliva auricular Politzer.....	406
McINTOSH juego de laringoscopio.....	31	Mogen instrumento para circuncision.....	556	Olivecrona elevador para duramadre.....	332
McINTOSH laringoscopio.....	29	Mollison separador.....	171	Olivecrona espátula cerebral.....	336
McIntyre canula lacrimal.....	394	Molt (Doyen-Jansen) abre-boca.....	454	Olivecrona pinza gubia.....	237
McIvor abre-boca.....	457	Molt periostotomo.....	276	Olivecrona sierra hilo.....	332
McKenty elevador para el tabique nasal.....	437, 438	mondador de tendones Brand.....	294	Olivecrona-Toennis pinza aplicadora.....	326
McKenzie pinza aplicadora.....	326	Moor cuchara para calculos biliares.....	532	Ollier separador.....	162
McLean forceps obstetrico.....	603	Moore perforador de mano.....	298	Olsen-Hegar porta aguja.....	212
McLean-Tucker forceps obstetrico.....	603	Moorfield pinza para sutura.....	392	Ombredanne martillo.....	273
McLean-Tucker-Luikart forceps obstetrico.....	603	Morgan proctoscopio.....	565	osteotomo.....	259-263, 265, 267
McPherson pinza para ligadura.....	392	Moritz-Schmidt baja-lengua.....	452	osteotomo.....	464
Mead martillo.....	271	Morris separador.....	164	osteotomo de hoja Obwegeser.....	464/1
Mead pinza gubia.....	235	Morris-DeBakey pinza para la aorta.....	506	osteotomo Epker.....	464/2
Meeker pinza hemostatica.....	119	Morse separador costal.....	484	osteotomo Hibbs.....	265
Mehdorn pinza para vasos.....	362	Morse-Favaloro separador costal.....	484	osteotomo Hoke.....	265
Mellinger blefarostato.....	370	Moynihan explorador apra calculos biliares.....	532	osteotomo Lambotte.....	261

osteotomo Lexer	263	periostotomo Matson	279	pinza cortante para huesos Semb	242
osteotomo Lexer Mini	263	periostotomo Matson-Alexander	279	pinza cortante para huesos Stamm	241
osteotomo Mini-Lambotte	262	periostotomo Molt	276	pinza cortante para huesos Stille-Horsley	242
osteotomo Obwegeser	463	periostotomo Obwegeser	462	pinza cortante para huesos Stille-Liston	242
osteotomo Stille	260	periostotomo Quervain	275	pinza cortante para laminectomia Cloward	342
Ostroem pinza sacabocado	430	periostotomo Sebileau	275	pinza cortante para laminectomia Cushing	340
O'Sullivan-O'Connor espejuelo vaginal	576	periostotomo Sedillot	274, 275	pinza cortante para laminectomia Ferris-Smith	343
O'Sullivan-O'Connor separador abdominal	181	periostotomo Seldin	277	pinza cortante para laminectomia Love-Gruenwald	340
Otis uretrotomo	553	periostotomo Semb	278	pinza cortante para laminectomia Oldberg	341
otoscopio UNI I	13	periostotomo Williger	276	pinza cortante para laminectomia Schlesinger	342
Overholt pinza hemostatica	114	Perkins separador	168	pinza cortante para laminectomia Spurling	340
Overholt-Baby pinza hemostatica	114	Perthes escariador	304	pinza cortante para laminectomia Wagner	343
Overholt-Geissendoerfer pinza hemostatica	114	Pestalozza cureta para aborto	606	pinza cuticular	610
Overholt-Mixer pinza hemostatica	115	Petri cubeta	620	pinza de agarre	305
P					
palanca para doblar placas Lane	325	Phaneuf pinza para peritoneo	123	pinza de agarre para capsula Millin	550, 551
Park blearostato	371	Pierce elevador para el tabique nasal	438	pinza de agarre para prostata Young	550
Parker separador	139	Pierce trocar para seno maxilar	204	pinza de agarre para tendones	292, 293
Parker-Langenbeck / Us Army separador	141	pieza de acomplamiento para curetas aspiradoras	600	pinza de agarre para tendones Brand	293
Partsch cincel	259	Pifard cureta para lupus	608	pinza de agarre para tendones Caroll	293
Partsch gubia	259	PINARD estetoscopio	23	pinza de agarre para tendones Jackson	292
Partsch martillo	271	pinza aplicadora	104	pinza de agarre para tendones Kleinert-Kutz	294
pasador de tendones Bunell	294	pinza aplicadora de clips	524, 525	pinza de agarre para tendones Steinmann	292
Passow cincel tamponador para huesos	260	pinza aplicadora McKenzie	326	pinza de aplicacion	357-360
Patella pinza para hueso	248	pinza aplicadora Olivecrona-Toennis	326	pinza de campo	132, 133
Paton disecador corneal	373	pinza aplicadora Raney	327	pinza de campo Backhaus	132
Paufique cuchillo para queratoplastica	373	pinza aplicadora Smithwick	326	pinza de campo Backhaus-Clip	132
Paufique pinza para ligadura	392	pinza aplicadora Sweet	326	pinza de campo Bernhard	133
Payr pinza intestinal y estomacal	548	pinza traumatica Gregory	517	pinza de campo Doyen	133
Payr sonda conductora	221	pinza traumatica REDA	111	pinza de campo Jones	132
Payr-Baby pinza intestinal y estomacal	548	pinza traumatica Rogers	127	pinza de campo Jones-Clip	132
Pean pinza hemostatica	108, 110	pinza auricular Harken	503	pinza de campo Lane	133
Peck Joseph tijera face lift	73	pinza auricular Hartmann	411	pinza de campo Moynihan	133
Pederson espejuelo vaginal	570	pinza auricular Littauer	411	pinza de campo Peers	132
Peers pinza de campo	132	pinza auricular Lucae	410	pinza de campo Roeder	132
Peet escofina nasal	446	pinza auricular micro	413, 414, 415	pinza de campo Schaedel	132
Peet pinza para espinas	92	pinza auricular micro Cos	414	pinza de campo Tohoku	132
Pelkmann pinza porta esponja	137	pinza auricular micro Dieter	414	pinza de diseccion Adlerkreutz	84
pelvimetro Collier	605	pinza auricular micro Greven	414	pinza de diseccion Adson	81/2, 82
pelvimetro Collin	605	pinza auricular micro Haugh	414	pinza de diseccion Adson-Brown	82
pelvimetro Martin	605	pinza auricular micro Juers	414	pinza de diseccion Adson-DeBakey	81/2
Penfield elevador para duramadre	333	pinza auricular micro McGee	414	pinza de diseccion Bonney	88
Pennington elevador para el tabique nasal	438	pinza auricular micro Wullstein	416	pinza de diseccion Brophy	84
Pennington pinza hemostatica	109	pinza auricular Tilley	411	pinza de diseccion Brown	83
Percy retractor para amputacion	296	pinza auricular Wilde (Troeltsch)	410	pinza de diseccion Collin-Duval	85
perforacraneo Smellie	607	pinza autocentradora para sostener huesos REDA	247	pinza de diseccion Cushing	83
perforador de mano	298, 299, 300, 304	pinza bronquial	126	pinza de diseccion Cushing-Taylor	87
perforador de mano Bunell	299	pinza bronquial Finochietto	490	pinza de diseccion Duhresen	84
perforador de mano Hudson	299	pinza bronquial Harrington	490	pinza de diseccion Durante	88
perforador de mano Kirschner	299	pinza bronquial Lees	504	pinza de diseccion Duval	85
perforador de mano Moore	298	pinza bronquial Price-Thomas	490	pinza de diseccion Ferris-Smith	85
perforador de mano Ralk	300	pinza bronquial Semb	491	pinza de diseccion Gerald	86, 87
perforador de mano REDA	300	pinza capsular Arruga	391	pinza de diseccion Gillies	86
perforador de mano Stille	298	pinza capsular Castroviejo	391	pinza de diseccion Graefe	83
perforador de mano Stille-Sherman	298	pinza capsular Elschmig	391	pinza de diseccion Lane	84
perforador inicial Crutchfield	327	pinza capsular Fuchs	391	pinza de diseccion Lerche	83
perforador medular	322	pinza capsular Gill-Arruga	390	pinza de diseccion Mayo	89
perforador para femur Kuntscher	321	pinza capsular Hess	391	pinza de diseccion McIndoe	85
perforador para la cavidad medular Kuntscher	321	pinza capsular Kalt	391	pinza de diseccion modelo ruso	85
periostotomo	274-280	pinza capsular Schweigger	391	pinza de diseccion modelo Strassburger	89
periostotomo Alexander	276	pinza capsular Terson	391	pinza de diseccion Nelson	89
periostotomo Cobb	280	pinza cierra-tubo	129	pinza de diseccion Ochsner	88
periostotomo Dingman	463	pinza cierra-tubo Bülow-Gunar-Hey	130	pinza de diseccion Oehler	81/1
periostotomo Doyen	278	pinza cierra-tubo Klinikum Berlin	129	pinza de diseccion Potts-Smith	81, 81/1
periostotomo Farabeuf	274	pinza cierra-tubo Presbyterian	129	pinza de diseccion Semken	86
periostotomo Farabeuf-Collin	274	pinza circular	432	pinza de diseccion Singley	88
periostotomo Fomon	277	pinza cortante Hajek-Koffler	429	pinza de diseccion Standard	81, 81/1
periostotomo Hargis	463/2	pinza cortante Kerrison	428	pinza de diseccion Stille	81, 81/1
periostotomo Joseph	277	pinza cortante para hipofisis	341	pinza de diseccion Stille-Barraya	88
periostotomo König	276	pinza cortante para huesos Böhler	241	pinza de diseccion Taylor	87
periostotomo Lambotte	274	pinza cortante para huesos Cottle-Kazanjan	241	pinza de diseccion USA	81, 81/1
periostotomo Langenbeck	275	pinza cortante para huesos Liston	241	pinza de diseccion Wagenstein	89
		pinza cortante para huesos McIndoe	241	pinza de diseccion Waugh	83
		pinza cortante para huesos Ruskin-Liston	241	pinza de proteccion Adson	298

pinza de reduction REDA	247	pinza hemostatica Lahey	119/2, 120	pinza nasal Takahashi	427
pinza de relojero	90	pinza hemostatica Lawrence	119	pinza nasal Troeltsch	424
pinza de traccion craneal Crutchfield	327	pinza hemostatica Leriche	111	pinza nasal Watson-Williams	428
pinza dental London-College	93	pinza hemostatica Lovelace	109	pinza nasal Weil-Blakesley	426
pinza dental Meriam	93	pinza hemostatica Lower	120	pinza nasal Westmacott	424
pinza depilatoria Barraquer	395	pinza hemostatica Martel	110	pinza para aborto Saenger	606
pinza depilatoria Beer	395	pinza hemostatica Mayo-Guyon	122	pinza para aborto Winter	606
pinza depilatoria Douglas	395	pinza hemostatica Meeker	119	pinza para agarrar el bocio Lahey	479
pinza depilatoria Gradle	395	pinza hemostatica Mixer	116, 119/1, 119/2, 120	pinza para amigdalas Marschik	468
pinza depilatoria Littauer	395	pinza hemostatica Mixer Baby	119/1	pinza para anastomosis Beck	516, 520
pinza depilatoria REDA	395	pinza hemostatica Mixer-O'Shaugnessy	119/2	pinza para anastomosis Cooley	519, 520
pinza estomacal Lane	547	pinza hemostatica Moynihan	120	pinza para anastomosis Cooley-Derra	519
pinza gubia Adson	236	pinza hemostatica Nissen	113	pinza para anastomosis De Martel-Wolfson	546
pinza gubia Bane-Hartmann	237	pinza hemostatica Overholt	114	pinza para anastomosis DeBaKey	505, 515
pinza gubia Beyer	237, 238	pinza hemostatica Overholt-Baby	114	pinza para anastomosis del recto Hayes	545
pinza gubia Blumenthal	236	pinza hemostatica Overholt-Geissendoerfer	114	pinza para anastomosis Derra	515
pinza gubia Böhrler	238	pinza hemostatica Overholt-Mixer	115	pinza para anastomosis Lambert-Kay	505
pinza gubia Cleveland	235	pinza hemostatica Pean	108, 110	pinza para anastomosis Potts	493
pinza gubia Echlin	240	pinza hemostatica Pennington	109	pinza para aneurisma de la aorta DeBaKey	496, 497, 498
pinza gubia Friedmann	234	pinza hemostatica Pratt	110	pinza para aneurisma DeBaKey-Bahnsen	506
pinza gubia Friedmann mini	234	pinza hemostatica Providence-Hospital	106	pinza para apendice Allen	544
pinza gubia Frykholm	240	pinza hemostatica Roberts	117	pinza para apendice Kleinschmidt	544
pinza gubia Jansen	237	pinza hemostatica Rochester-Carmalt	109	pinza para aplicar agrafes Childe	224
pinza gubia Kleiner-Kutz	237	pinza hemostatica Rochester-Ochsner	108	pinza para aplicar agrafes Hegebarth	224
pinza gubia Leksell (Stille)	240	pinza hemostatica Rochester-Pean	108	pinza para aplicar agrafes Michel	224
pinza gubia Lempert	237	pinza hemostatica Rumel	117	pinza para aplicar agrafes Wachenfeldt	224
pinza gubia Luer	236	pinza hemostatica Sarot	118	pinza para aplicar y quitar agrafes Michel	224
pinza gubia Marquardt	239	pinza hemostatica Spencer-Wells	109	pinza para arrancar uñas Radolf	297
pinza gubia Mayfield	238	pinza hemostatica Stille	122	pinza para arrancar vendaje enyesado Wolff	233
pinza gubia Mead	235	pinza hemostatica Toennis	117	pinza para biopsia Alexander	589
pinza gubia Micro Friedmann	234	pinza hemostatica Tuffier	110	pinza para biopsia Baby Burke	590
pinza gubia Olivecrona	237	pinza hemostatica Wikstroem	117	pinza para biopsia Baby-Tischler	592
pinza gubia Ruskin	239	pinza hemostatica Willet Martel	110	pinza para biopsia Burke	590
pinza gubia Sauerbruch	240	pinza hemostatica Zenker	118	pinza para biopsia Eppendorfer	590
pinza gubia Scaglietti	240	pinza intestinal Allis	537	pinza para biopsia Faure	588
pinza gubia Semb	240	pinza intestinal Allis-Adair	537	pinza para biopsia Kevorkian	589, 591
pinza gubia Smith-Petersen	238	pinza intestinal Allis-Baby	537	pinza para biopsia Kevorkian-Pacific	592
pinza gubia Stellbrink	234	pinza intestinal Babcock	539	pinza para biopsia Maxi Grasper	593
pinza gubia Stille-Luer	239	pinza intestinal Baby-Kocher	540	pinza para biopsia Mini-Townsend-Down	591
pinza gubia Stille-Ruskin	239	pinza intestinal Boys-Allis	538	pinza para biopsia Mini-Townsend-Up	591
pinza gubia Zaufal-Jansen	238	pinza intestinal Brunner	543	pinza para biopsia rectal Turrel	567
pinza hemorroidal Heywood-Smith	567	pinza intestinal Doyen	540	pinza para biopsia rectal Yeoman	566, 567
pinza hemostatica Adson	112, 113	pinza intestinal Doyen-Baby	540	pinza para biopsia Schubert	588
pinza hemostatica Adson Baby	113	pinza intestinal Fehland	542	pinza para biopsia Schumacher	588, 589
pinza hemostatica atraumatica DeBaKey-Mosquito	509	pinza intestinal Judd-Allis	538	pinza para biopsia Serpentine-Grasper	593
pinza hemostatica atraumatica DeBaKey-Pean	513	pinza intestinal Kocher	540	pinza para biopsia Thomas-Gaylor	588
pinza hemostatica atraumatica DeBaKey-Rankin	512	pinza intestinal Littlewood	538	pinza para biopsia Tischler-Down	591
pinza hemostatica Bainbridge	119/2	pinza intestinal Lockwood-Allis	538	pinza para biopsia Tischler-Kevorkian	592
pinza hemostatica Bengolea	112	pinza intestinal Mayo-Robson	541	pinza para biopsia Tischler-Morgan	590, 591
pinza hemostatica Birkett	116	pinza intestinal Mikulicz	543	pinza para biopsia Tischler-Up	591
pinza hemostatica Bridge	116	pinza intestinal Resano	542	pinza para biopsia Townsend	591
pinza hemostatica Chaput	110	pinza intestinal Scudder	541	pinza para biopsia van Doren	588
pinza hemostatica Collier-Crile	106	pinza intestinal Stone-Watt	545	pinza para biopsia Wittner	589
pinza hemostatica Collin	110	pinza intestinal Thoms-Allis	538	pinza para bronco-esofagoscopia Chevalier-Jackson	473
pinza hemostatica Crafoord	118	pinza intestinal y estomacal Payr	548	pinza para calculos biliares Blake	531
pinza hemostatica Crafoord-Sellors	119	pinza intestinal y estomacal Payr-Baby	548	pinza para calculos biliares Desjardins	531
pinza hemostatica Crile	107	pinza maleolar	247	pinza para calculos biliares Mayo-Blake	531
pinza hemostatica Crile-Rankin	107	pinza muscular Berke	389	pinza para calculos biliares Mixer	531
pinza hemostatica Dandy	109	pinza muscular Mastin	479	pinza para calculos renales Heimig	536
pinza hemostatica Desjardins	121	pinza muscular Prince	386	pinza para calculos renales Randall	535
pinza hemostatica Ferguson	109	pinza muscular Snellen	393	pinza para campo Ball and Socket	133
pinza hemostatica Fuchsig	113	pinza nasal Bruenings	425	pinza para campo Lorna	133
pinza hemostatica Gemini	115	pinza nasal Hartmann	424, 427	pinza para capsuloridectom Holth	380
pinza hemostatica Gray	121	pinza nasal Heymann	425	pinza para cartilagos Martin	246
pinza hemostatica Guyon	122	pinza nasal Heymann-Knight	425	pinza para cateter Cooley	510
pinza hemostatica Halsted-Mosquito	105	pinza nasal Jansen	424	pinza para cerrar clamps De Martel-Wolfson	546
pinza hemostatica Hartmann	104	pinza nasal Jansen-Gruenwald	424	pinza para cerrar clamps Stone	545
pinza hemostatica Heiss	112	pinza nasal Knight	425	pinza para chalazion Desmarres	393
pinza hemostatica Johns-Hopkins	120	pinza nasal Lubet-Barbon	424	pinza para chalazion Lambert	393
pinza hemostatica Kantrowitz	119/1	pinza nasal Luc	426	pinza para coartacion Potts	492
pinza hemostatica Kelly	106	pinza nasal Myles	427	pinza para coger amigdalas Abraham	468
pinza hemostatica Kelly-Rankin	106	pinza nasal Schmeden	427	pinza para coger amigdalas Ballenger	467
pinza hemostatica Kocher	108	pinza nasal Struckyen	427	pinza para coger amigdalas Blohmke	467

pinza para coger amígdalas Colver	467	pinza para introducir cateter MAGILL.....	28	pinza para torcer hilo Berry	319
pinza para coger amígdalas Negus	467	pinza para iris Barraquer (Colibri)	384	pinza para torcer hilo Corwin-Hegar	319
pinza para coger amígdalas Tyding	468	pinza para iris Barraquer-Katzin.....	384	pinza para torcer hilo Mayo-Haberisser.....	319
pinza para coger amígdalas White.....	467	pinza para iris Bishop-Harman.....	386	pinza para tracomma Knapp-Luer	393
pinza para coger el pulmon Lovelace	490	pinza para iris Colibri.....	384	pinza para tumores Landolt	341
pinza para coger las amígdalas Sawtell.....	467	pinza para iris Fischer	384	pinza para tumores Yasargil	97
pinza para coger las amígdalas Schmidt.....	467	pinza para iris Foerster.....	383	pinza para uso multiple Glover	515
pinza para columna Cottle	448	pinza para iris Gill	384	pinza para uterus Green-Armytage.....	605
pinza para cordón espermático	553/2	pinza para iris Gill-Hess	384	pinza para vasectomía	553/2
pinza para cuerpos extraños Mathieu	553/1	pinza para iris Graefe	382	pinza para vasos Biemer	361
pinza para desechos Sauerbruch	227	pinza para iris Hess	384	pinza para vasos Mehdorn.....	362
pinza para el pene Stockmann	553/1	pinza para iris Stevens	383	pinza para vasos periféricos DeBaKey	494
pinza para el pene Strauss	553/1	pinza para iris Troutman	389	pinza para vasos periféricos Leland-Jones	494
pinza para el tunel del tendón	293	pinza para iris Troutman (Colibri).....	384	pinza para vasos Satinsky.....	491
pinza para el útero Collin	585	pinza para la aorta Dietrich	510	pinza porta esponja Bozemann	138
pinza para el útero Dartigues	585	pinza para la aorta Morris-DeBaKey	506	pinza porta esponja Bozemann-Douglas.....	138
pinza para el útero Somer	585	pinza para la aorta Subramanian	521	pinza porta esponja Cheron	137
pinza para enderezar el tabique nasal Asch	449	pinza para la aorta Subramanian-Miniature.....	521	pinza porta esponja Collin	137
pinza para enderezar el tabique nasal Walsham	449	pinza para la aorta Weber	501	pinza porta esponja Lister (Sinus).....	137
pinza para espinas Archer.....	92	pinza para laringe Fraenkel	471	pinza porta esponja Pelkmann.....	137
pinza para espinas Carmalt.....	91	pinza para ligadura Ayer.....	393	pinza porta-esponja Duplay	134
pinza para espinas Feilchenfeld.....	91	pinza para ligadura DeBaKey	493	pinza porta-esponja Gross-Maier	134
pinza para espinas Hunter	91	pinza para ligadura DeBaKey	499, 500	pinza porta-esponja Sims-Maier	134
pinza para espinas Peet.....	92	pinza para ligadura McPherson	392	pinza sacabocado Citelli	430
pinza para espinas Stieglitz	92	pinza para ligadura Millin	551	pinza sacabocado craneal Cone.....	331
pinza para espinas Virtus (Ralk)	92	pinza para ligadura Mod. Tübingen	392	pinza sacabocado craneal DeVilbiss	332
pinza para esterilización	227	pinza para ligadura Paufigue.....	392	pinza sacabocado Hajek-Kofler	431
pinza para esterilización Cheatle	227	pinza para ligadura y la aorta DeBaKey-Semb	499	pinza sacabocado Ostroem	430
pinza para esterilización de jeringas Davis	227	pinza para lobo anterior Millin	551	pinza sacabocado para discos intervertebral	
pinza para esterilización Rogge	227	pinza para magullar tabique Rubín	428	Colclough	344/1
pinza para esterilización Universal	227	pinza para medicación Bryant	137	pinza sacabocado para discos intervertebral	
pinza para estrabismo Bonaccolto	385	pinza para microcirugía	96	Ferris-Smith-Kerrison	344, 344/2
pinza para estrabismo Dastoor	386	pinza para micro-cirugía de la laringe.....	474	pinza tira-lengua Collin	453
pinza para estrabismo Jameson	385	pinza para oclusión tangencial DeBaKey-Satinsky	502	pinza tira-lengua Young.....	453
pinza para estrabismo McCullough	385	pinza para pedículo Herrick	123	pinza uterina Barrett	582
pinza para fijación Barraquer	390	pinza para pericraneo Gauss	605	pinza uterina Braun	582
pinza para fijación Castroviejo	390	pinza para peritoneo Faure	123	pinza uterina Czerny.....	584
pinza para fijación Cottle	410	pinza para peritoneo Mikulicz	123	pinza uterina Duplay	582
pinza para fijación Elschrig	389	pinza para peritoneo Phaneuf	123	pinza uterina Hulka	583
pinza para fijación Graefe	389	pinza para polipos Hartmann	412	pinza uterina Iowa	584
pinza para fijación Green	390	pinza para polipos Hartmann-Hoffmann.....	412	pinza uterina Jacobs	583
pinza para fijación Kirby-Arthur.....	385	pinza para polipos Hartmann-Wulstein.....	412	pinza uterina Jarcho	583
pinza para fijación Lester	389	pinza para polipos laringeos Jurasz.....	471	pinza uterina Museux	583
pinza para hemorroides McGivney	568	pinza para polipos Littauer.....	425	pinza uterina Pratt	584
pinza para hipofisis Adson	334	pinza para polipos Noyes.....	425	pinza uterina Schröder	584
pinza para histerectomía Heaney	126	pinza para polipos Schrempel	412	pinza uterina Schroeder	583
pinza para histerectomía Heany-Ballentine	127	pinza para polipos uterinos Doyen	585	pinza uterina Schroeder (Pozzi).....	582
pinza para histerectomía Holzbach	126	pinza para polipos uterinos Kelly	585	pinza uterina Skene	582
pinza para histerectomía Segond	125	pinza para polipos uterinos Noto	585	pinza uterina Staude-Moore	582
pinza para histerectomía Segond-Landau	125	pinza para quitar agrafes Collin	224	pinza uterina Teale	583
pinza para histerectomía Wertheim	124, 128	pinza para quitar agrafes Richter-Heath	224	pinza vascular.....	526
pinza para histerectomía Wertheim-Cullen	125	pinza para reducción	246	pinza vascular Cooley	520
pinza para hueso Bircher-Ganske	246	pinza para reposición Rowe.....	459	pinza vascular de uso múltiple Bainbridge	495
pinza para hueso Dingmann	246	pinza para secuestros	249	pinza vascular de uso múltiple Cooley	518-520
pinza para hueso Farabeuf.....	243	pinza para secuestros VAN Buren	249	pinza vascular de uso múltiple DeBaKey	495, 507, 508, 514, 515
pinza para hueso Farabeuf-Lambotte.....	243	pinza para senoscopia	431	pinza vascular Neonatal	523
pinza para hueso Fergusson	243	pinza para shunt carotídeo Javid.....	511	pinza vascular para neotales Castaneda	527
pinza para hueso Kern	244	pinza para sostener placas Lane	325	pinza vascular pediátrica Cooley	522
pinza para hueso Lambotte	244	pinza para sostener tornillos Lane	325	pinza vascular pediátrica DeBaKey.....	516, 517
pinza para hueso Lane	244	pinza para sutura Castroviejo	392	pinzas atraumáticas DeBaKey	98, 99
pinza para hueso Langenbeck	243	pinza para sutura Mod. Bonn.....	386	pinzas de disección	81, 81/1
pinza para hueso Lewin	246	pinza para sutura Mod. Tübingen	386	pinzas para espinas	91, 92
pinza para hueso Patella	248	pinza para sutura Moorfield	392	pinzas Ultra-Ligera	95
pinza para hueso REDA	246	pinza para sutura St. Martin	392	Piper forceps obstétrico.....	604
pinza para hueso Reill	248	pinza para tabique nasal Graig	426	Pistola lavadora	626
pinza para hueso Semb	243	pinza para tabique nasal Middleton-Jansen.....	430	placa para extender la piel.....	49
pinza para hueso Ulrich	248	pinza para tapones	135	placa para párpado Jaeger	371
pinza para hueso Verbrugge	245	pinza para tapones Jackson	471	plato para tabletas	621
pinza para huesos autocentrantes.....	245	pinza para tapones Ulrich	135	Plester cuchillo	418
pinza para huesos Feldheim	249	pinza para tejido Collin	539	Plester separador	171
pinza para huesos Lambert-Lowman	249	pinza para tejido Duval	539	Plester tubo de aspiración	338
pinza para huesos Lowman	249	pinza para tejido Williams	539	polipotomía Krause	433/2
pinza para huesos Lowman-Hoglund	249	pinza para tendones Larsen	292		

polipotomo Krause-Voss.....	433/2	Pratt especulo rectal	559	Reill pinza para hueso	248
polipotomo Wilde	433/2	Pratt pinza hemostatica	110	Reiner cuchillo para vendaje enyesado	233
Politzer aguja para paracentesis	408	Pratt pinza uterina	584	Reiner jeringa auricular.....	406
Politzer cuchillo auricular	408	Pratt sonda para fistula.....	563	Resano pinza intestinal	542
Politzer especulo auricular	399	PRECISA esfigmomanometro	9	RESANO tijera para capsula	53/2
Politzer oliva auricular	406	Presbyterian pinza cierra-tubo	129	retractor nasal Aufrecht	447
POOLE tubo de aspiracion	27	Price-Thomas pinza bronquial	490	retractor nasal Cottle	447, 447/1
porta aguja (micro) Barraquer	216, 217	Prince pinza muscular	386	retractor nasal Kilner	447/1
porta aguja (micro) Barraquer-Troutmann	216	PRINCE tijera para amigdalas	59	retractor nasal Masing.....	447
porta aguja (micro) Castroviejo-Standard	216	protoscopio Bensaude	565	retractor nasal Masing-Neivert	447
porta aguja Adson	211	protoscopio Fansler	564	retractor para amputacion Percy	296
porta aguja Arruga	214	protoscopio Kelly	562, 563	Reverdin aguja.....	220
porta aguja Baby-Olsen-Hegar	212	protoscopio Morgan	565	Reverdin separador abdominal	143/1
porta aguja Baumgartner	208	protector Arruga	378	REYNOLDS tijera para cirugia	54
porta aguja Boynton	214	Providence-Hospital pinza hemostatica	106	Reynolds tijera supercut	72
porta aguja Bozemann	211	punta de pinza Baracani	472	Ribbon espátula abdominal	143
porta aguja Brown	209	punta de pinza Bruenings	472	Ricard separador abdominal	191
porta aguja Castroviejo	215	punta de pinza Cordes	472	Richardson Grip separador	142
porta aguja Castroviejo-Micro.....	215	punta de pinza Fraenkel	472	Richardson separador	142
porta aguja Collier	208	punta de pinza Krause	472	Richardson-Eastman separador	142
porta aguja Crile	213	punta de pinza Lange	472	Richnau-Holmgren especulo auricular	400
porta aguja Crile-Murray	209	punta de pinza Scheimann	472	Richter-Heath pinza para quitar agrafes	224
porta aguja Crile-Wood	209	punta de pinza Schumacher	472	Rienhoff-Finochietto separador costal	486
porta aguja DeBakey.....	210	punta de pinza Seifert	472	Rigby separador	189/2
porta aguja DERF	208	Putti lima para huesos	294	RI-MINI estuche de diagnostico	17
porta aguja Finochietto	211			Ring baja-lengua	455
porta aguja Gillies.....	212	Q		riñoneras	619
porta aguja Halsey	208	Quervain periototomo.....	275	Ritter-Halle dilatador para el seno	433
porta aguja Heaney	210	Quinby tijera para encias	67	Robb disecador vascular	530
porta aguja Hoesel	213	Quire elevador para cuerpos extraños.....	412	Robb espátula para la intima	530
porta aguja Jacobsen	215	Quising martillo	271	Roberts pinza hemostatica	117
porta aguja Johnson	211	quistotomo Becker	375	Rochester-Carmalt pinza hemostatica	109
porta aguja Kalt	214	quistotomo Graefe	375	Rochester-Ochsner pinza hemostatica	108
porta aguja Kalt-Arruga.....	214	quita hojas	42	Rochester-Pean pinza hemostatica	108
porta aguja Kilner	212			Roeder pinza de campo	132
porta aguja Langenbeck	213	R		Roger elevador para el tabique nasal	437
porta aguja Lichtenberg	213	Radolf pinza para arrancar uñas.....	297	Roger pinza atraumatica	127
porta aguja Masson	210	Ragnell separador	140	Rogge pinza para esterilizacion	227
porta aguja Mathieu	213	Ralk (Virtus) pinza para espinas	92	Rollet cinceal para extirpacion	374
porta aguja Mathieu-Olsen	212	Ralk perforador de mano	300	Rollet gancho	375
porta aguja Mayo-Hegar	209	Rampley porta esponjas	136	rompe hojas CASTROVIEJO	45
porta aguja Metzbaum	211	Ramus separador para el ramo	461	rompe hojas REDA	45
porta aguja Microvascular	210	Randall cureta aspiradora para biopsia uterina	587	rompe hojas TROUTMAN-CHRIS	45
porta aguja Neivert	208	Randall pinza para calculos renales	535	Rose separador	140
porta aguja Olsen-Hegar	212	Raney grapa para cuero cabelludo	327	Rosen cuchillo	418
porta aguja Ryder	210	Raney pinza aplicadora	327	Rosen gancho	419
porta aguja Sarot.....	211	raquioto	267	Rosen tubo de aspiracion	338
porta aguja Stevens	214	Ray cureta para hipofisis	334	Roser-Koenig abre-boca	454
porta aguja Stratte	212	Recamier curetas uterinas.....	597	rotador Beichert	379
porta aguja Wangenstein	210	REDA cucharilla cortante	256	Roux Baby separador	140
porta aguja Webster	208	REDA cuchillo de hoz	435	Roux mini separador	140
porta aguja Young Boomerang	220	REDA cuchillo para amputacion	44	Roux separador	139
porta esponjas Foerster	136	REDA diapason	403	Rowe pinza para reposicion.....	459
porta esponjas Rampley	136	REDA especulo nasal	423	Rubin cinceal nasal	440
porta ligadura para tournique.....	528	REDA Excenter tijera para vendaje.....	69/2	Rubin pinza para magullar tabique	428
porta pinza de traslado	615	REDA gancho	150	Rudd ligador para hemorroides	568
porta-algodon Farrell	203	REDA iman ocular	395	Rumel pinza hemostatica	117
porta-algodon Jobson-Horne	203	REDA instrumento para vendaje enyesado	232	Rumel-belmont tournique	528
porta-algodon REDA	203	REDA micro tijeras	77, 80	Ruskin pinza gubia	239
porta-algodon Tobold	203	REDA perforador de mano	300	Ruskin-Liston pinza cortante para huesos	241
porta-algodon Uckermann	203	REDA pinza atraumatica	111	Russel-Davis baja-lengua.....	458
porta-algon	203	REDA pinza autocentradora para sostener huesos	247	Rydel-Seiffert diapason.....	404
porta-clamps De Martel-Wolfson	546	REDA pinza de reduction	247	Ryder porta aguja.....	210
portador de luz fria KLEINSASSER	36	REDA pinza depilatoria	395		
portador de luz HOLINGER	37	REDA pinza para hueso	246	S	
portador de luz JACKSON	37	REDA porta-algodon	203	Saalfeld saca comedones	608
POTTS DE MARTEL tijera vascular.....	59	REDA rompe hojas	45	saca comedones Saalfeld	608
Potts pinza para anastomosis.....	493	REDA sierra para abrir anillos	297	saca comedones Schamberg	608
Potts pinza para coartacion	492	REDA sonda conductora	221	saca comedones Unna	608
Potts-Smith pinza de diseccion	81, 81/1	REDON aguja de guia	207	saca comedones Walton	608
Potts-Smith tijera vascular	61	Rees tijera face lift.....	73	Sachs elevador para duramide	332
Pozzi (Schroeder) pinza uterina.....	582	regla	25	Sachs gancho para nervio	329
Pratt dilatador uterino	580	Reichert depresor para epiglotis.....	471	Saenger pinza para aborto	606

salpingografo Schultze.....	596	separador abdominal Baby Gosset	181	separador intra oral L&M	463/4
SANVERNERO tijera para cirugia.....	54	separador abdominal Back holder.....	192, 193, 194, 195	separador Israel.....	162
Sarot pinza hemostatica.....	118	separador abdominal Balfour.....	182, 183	separador Jackson-Burrows.....	189/2
Sarot porta aguja.....	211	separador abdominal Balfour Baby	182, 183	separador Jansen.....	168
Satinsky pinza para vasos.....	491	separador abdominal Balfour-us.....	184	separador Kelly	142, 164
Satinsky tijera para vasija	65/2	separador abdominal Charnley	289	separador Kelly Grip.....	142
Sato cuchillo corneal.....	373	separador abdominal Collin	190	separador KOCHER.....	155
Satterlee sierra para amputacion	296	separador abdominal Collin Loktite	191	separador Kocher-Langenbeck.....	159, 160, 163
Sauerbruch costotomo.....	481	separador abdominal Denis-Browne	185	separador Kocher-Langenbeck.....	159
Sauerbruch pinza gubia	240	separador abdominal Doyen.....	189/1	separador Koerte.....	162
Sauerbruch pinza para desechos	227	separador abdominal Frazier	181	separador König.....	153
Sauerbruch separador	164, 166	separador abdominal Gosset	181	separador Körte	143/1
Sauerbruch-Frey costotomo	481	separador abdominal Kirschner.....	185, 187, 187/1	separador Lahey.....	157
Sawtell pinza para coger las amigdalas.....	467	separador abdominal Kümmel.....	143/2	separador Langenbeck	158, 159
Sawyer especulo rectal	560	separador abdominal O'Sullivan-O'Connor.....	181	separador Langenbeck-Green	153
SAVRE elevador	281	separador abdominal Reverdin	143/1	separador Little	157
Scaglietti pinza gubia.....	240	separador abdominal Ricard	191	separador Luer	140
Scalp-Contour separador	169	separador Adson.....	172, 173, 174	separador mamarío Breast.....	198
Scapula (Davidson) separador	166	separador Alm	168	separador manibular Obwegeser.....	461
Schaedel pinza de campo.....	132	separador Anderson	198	separador Martin	175/1
Schamberg saca comedones	608	separador Anderson Adson	172	separador Mathieu	141
Schede cucharilla cortante.....	373	separador Aufranc-Cobra	289	separador Mayo-Adams.....	171
Scheie cuchillo para goniotomia	472	separador Beckmann	176	separador Mayo-Collins	141
Scheinmann punta de pinza	472	separador BECKMANN-ADSON	175	separador Meyering	157, 177, 180
Scherbak especulo vaginal	575	separador Beckmann-Eaton	176	separador Middeldorf.....	160
Schimmelbusch tambores para esterilizacion	621	separador Brunner	167	separador Mikulicz	163
SCHINK dermatomo.....	49	separador Caspar.....	179, 180	separador Mollison	171
Schioetz tonometro.....	394/2	separador Cloward	178	separador Morris	164
Schlesinger pinza cortante para laminectomia.....	342	separador Collin	139	separador Murphy	156
Schmeden pinza nasal	427	separador Collin-Hartmann	141	separador nasal Converse	448
Schmid canula para lavador vascular.....	338	separador Cooley	148	separador Norfolk / Norwich	172
Schmieden sonda conductora	221	separador Coronal Blow Lift	198	separador obstetrico Sellheim	607
Schmieden-Dick aguja para ligadura	219	separador Coryllos (Thorax)	166	separador Ollier	162
Schmieden-Payr sonda conductora	221	separador costal Cooley	485, 487	separador para cirugia plastica Ferriera	197
Schmieden-Taylor tijera duramadre.....	65/1	separador costal De Boer	486	separador para cirugia plastica Tebbetts.....	197
Schmidt pinza para coger las amigdalas.....	467	separador costal Finochietto	482, 484	separador para cuerpo vertebral Cloward	339
Schoenborn separador para la glandula tiroidea.....	479	separador costal Finochietto-Burford	483	separador para cuerpo vertebral Inge	339
Schröder curetas uterinas.....	595	separador costal Haight.....	487	separador para el borde anterior Hargis.....	463
Schröder pinza uterina	584	separador costal Morse	484	separador para el cuerpo mandibular Hargis	463/6
Schroeder (Pozzi) pinza uterina.....	582	separador costal Morse-Favaloro	484	separador para el ramo Ramus	461
Schroeder pinza uterina	583	separador costal Rienhoff-Finochietto	486	separador para el ramo Spina-Nasalis	461
Schubert pinza para biopsia	588	separador costal Tuffier	487	separador para la glandula tiroidea Schoenborn.....	479
Schuhknecht cuchillo	418	separador Crile	140	separador para la raiz de nervios D'Errico	329/2
Schultze salpingografo	596	separador cuello vejiga Millin	553	separador para la raiz de nervios Hess	329/1
Schulze-Bergmann especulo rectal	560	separador Cushing	151, 152, 153	separador para la raiz de nervios Holsher	329/1
Schumacher pinza para biopsia	588, 589	separador Darling	178	separador para la raiz de nervios Love	329/2, 330
Schumacher punta de pinza	472	separador Davidson (Scapula)	166	separador para la raiz de nervios Scoville.....	329/1, 330
Schumacher tijera para cordon umbilical	64	separador de mobilizacion Tessier.....	463/3	separador para labios y mejillas	453
Schumacher tijera para esternon	481	separador de pelvis St. Marks	165	separador para labios y mejillas Sternberg	453
Schweigger pinza capsular	391	separador de sistema Leyla	368-368/4	separador para laminectomia Cherry.....	488
Scoville cucharilla cortante	253	separador DEEVER	145, 146	separador para laminectomia Scoville.....	196
Scoville separador para la raiz de nervios.....	329/1, 330	separador DEEVER GRIP	146	separador para laminectomia Scoville-Haverfield.....	196
Scoville separador para laminectomia.....	196	separador DeBakey.....	189/1	separador para menisco Smillie.....	291
Scoville-Haverfield separador para laminectomia	196	separador Desmarres	151	separador para paladar Nager	465
Scudder pinza intestinal	541	separador Doyen	163	separador para partes blandas Obwegeser	460
Sebileau periostotomo	275	separador Doyen-Stille.....	167	separador para pilar Hofer.....	465
Sedillot periostotomo	274, 275	separador espinal Taylor	291	separador para piloro Benson	544
Segond bisturi para fibroma.....	594	separador Farabeuf	139	separador para rodilla Blount.....	289
Segond pinza para histerectomia	125	separador Finsen.....	168	separador para tejido cervical Cloward	339
Segond-Landau pinza para histerectomia	125	separador Freeman	198	separador para tendones Bunell	292
Seifert punta de pinza	472	separador Fritsch	163	separador para uvula Love.....	465
Seldin periostotomo	277	separador Gil-Vernet	152	separador para yesos Beeson	232
Sellheim separador obstetrico	607	separador Goelet.....	141	separador para yesos Haglund-Stille.....	232
Semb periostotomo	278	separador Green	160	separador para yesos Henning	232
Semb pinza bronquial	491	separador Harrington	147	separador Parker	139
Semb pinza cortante para huesos.....	242	separador Harrington-Pemberton	147	separador perineal Gelpi	189/1, 189/2
Semb pinza gubia	240	separador Heaney	164	separador Perkins	168
Semb pinza para hueso	243	separador Henley	170	separador Plester	171
Semken pinza de diseccion	86	separador Hibbs	164	separador prostatico Young	550
Semm especulo vaginal	571	separador Holzheimer	168	separador Ragnell	140
Senn-Green separador	153	separador Hösel	167	separador rectal Smith-Buie	561
Senn-Miller separador	143	separador intestinal Leriche.....	143/2	separador Richardson	142
sensimetro WARTENBERG	25	separador intra oral	463/1, 463/4	separador Richardson Grip	142

separador Richardson-Eastman	142	Sinsky gancho	376	Stevenson blerarostato	371
separador Rigby	189/2	Sinus (Lister) pinza porta esponja	137	Stieglitz pinza para espinas	92
separador Rose	140	Sinus sonda para sinoscopia	438	Stille (Leksell) pinza gubia	240
separador Roux	139	sistema de brazo	188, 189	Stille cincel	260
separador Roux Baby	140	Skene pinza uterina	582	Stille cizalla para yesos	229
separador Roux mini	140	Sluder-Ballenger amigdalotomo	470	Stille costotomo	480
separador sagital Smith	463/5	Smellie gancho obstetrico	605	Stille gubia	260
separador Sauerbruch	164, 166	Smellie perforacraneo	607	Stille osteotomo	260
separador Scalp-Contour	169	Smillie meniscotomo	292	Stille perforador de mano	298
separador Senn-Green	153	Smillie separador para menisco	291	Stille pinza de diseccion	81, 81/1
separador Senn-Miller	143	Smith blefarostato	370	Stille pinza hemostatica	122
separador Simon	164	Smith separador sagital	463/5	Stille-Barraya pinza de diseccion	88
separador Strandell-Stille	157	Smith Us Army tijera para gaza	69/1	Stille-Horsley pinza cortante para huesos	242
separador toracico Mercedes	489	Smith-Buie separador rectal	561	Stille-Liston pinza cortante para huesos	242
separador traqueal Bose	476	Smith-Petersen cincel	261	Stille-Luer pinza gubia	239
separador traqueal Jackson	476	Smith-Petersen gubia	261	Stille-Ruskin pinza gubia	239
separador Travers	172	Smith-Petersen pinza gubia	238	Stille-Sherman perforador de mano	298
separador Tuffier	147	Smithwick gancho para nervio	329	Stockmann pinza para el pene	553/1
separador US ARMY / Parker-Langenbeck	141	Smithwick pinza aplicadora	326	Stone pinza para cerrar clamps	545
separador vesical Judd-Masson	552	Snellen asa	378	Stone-Watt manguito de cierre	545
separador vesical Legueu	553	Snellen pinza muscular	393	Stone-Watt pinza intestinal	545
separador vesical Millin	552	Somer pinza para el utero	585	STRABISMUS tijera	58
separador vesical Thomson-Walker	552	sonda abotonada Jacobson	335	Strandell-Stille separador	157
separador Volkmann	153, 154, 156	sonda acanalada	199	Strassburger pinza de diseccion	89
separador Weitlaner	169	sonda acanalada Brodie	199	Stratte porta aguja	212
separador Weitlaner-Wullstein	169	sonda auricular Stacke	199	Strauss pinza para el pene	553/1
separador Wullstein	171	sonda conductora Brunner	221	Struempel pinza para polipos	412
separador Yancoskie	198	sonda conductora Kirschner	221	Strully tijera para neurocirugia	65
separador Zenker	161	sonda conductora Koenig	221	Struycken pinza nasal	427
Serpentine Grasper pinza para biopsia	593	sonda conductora Payr	221	Subramanian pinza para la aorta	521
serra-fina Dieffenbach	104	sonda conductora REDA	221	Subramanian-Miniature pinza para la aorta	521
serra-fina Johns-Hopkins	104	sonda conductora Schmieden	221	Supercut tijera Baby Metzenbaum	71
Seutin tijera para vendaje	69/2	sonda conductora Schmieden-Payr	221	Supercut tijera Iris	72
Sexton cuchillo auricular	408	sonda conductora Vienna	221	Supercut tijera Kliner/Ragnell	72
Shambaugh gancho	419	sonda Fish	199	Supercut tijera La Grange	72
Shapleigh asa	410	sonda Harms	381	supercut tijera Lister	72
Shea tijera auricular micro	413	sonda lacrimal Bowman	381	Supercut tijera Mayo	71
Sheehan cincel nasal	441	sonda lacrimal Worst	381	Supercut tijera Mayo-Stille	71
Sheets canula	394/2	sonda Nelaton	199	Supercut tijera Metzenbaum	71
Siebenmann dilatador para el seno	433/1	sonda para bocio Kocher	479	supercut tijera Reynolds	72
Siebold tijera ginecologica	62	sonda para calculos biliares Mayo	534	supercut tijera Stevens	72
Siegle especulo auricular	402	sonda para fistula Lockhart-Mummery	200	supercut tijera wagner	72
sierra hilo Olivecrona	332	sonda para fistula Pratt	563	Supercut tijeras	71, 72
sierra nasal Joseph	446	sonda para mesurar House	420	Sweet pinza aplicadora	326
sierra oscilante con aspiracion	231	sonda para sinoscopia Sinus	438	Systrunk tijera para cirugia	66
sierra oscilante para vendajes enyesados	230	soporte de esterilizacion para alambres de Kirschner	305		
sierra para abrir anillos REDA	297	soporte de pecho Negus	459	T	
sierra para abrir anillos Walton	297	soporte pectoral KLEINSASSER	36	Tabb cuchillo	418
sierra para amputacion Bier	296	Spencer tijera para ligadura	66	Takahashi pinza nasal	427
sierra para amputacion Charriere	296	Spencer-Wells pinza hemostatica	109	taladros	302
sierra para amputacion Langenbeck	296	Spinal cucharilla cortante	253	tambores para esterilizacion Schimmelbusch	621
sierra para amputacion Satterlee	296	Spina-Nasalis separador para el ramo	461	tamponeador Luniatshchek	465
sierra para autopsia	231/1, 231/2, 231/3	Spratt cucharilla cortante	251	Tarnier cranioclasto	607
sierra para vendajes enyesados Engel	229	Spurling pinza cortante para laminectomia	340	Tarnier forceps obstetrico	604
silleta	621	St. Marks separador de pelvis	165	tarros	620
Silver cincel nasal	442	St. Martin pinza para sutura	392	TAYLOR martillo de percusion	24
SILVER dermatomo	50	St. Clair-Thomson cuchillo para vegetaciones adenoides	450	Taylor pinza de diseccion	87
Simcoe canula	394/2	Stacke sonda auricular	199	Taylor separador espinal	291
Simon cucharilla uterina	594	Stamm pinza cortante para huesos	241	Teale pinza uterina	583
Simon separador	164	Standard (Nelson) trocar abdominal	204	Tebbetts separador para cirugia plastica	197
Simplex cierra-tubos	624	Standard estuche para sutura	226	Thomas-Gaylor pinza para biopsia	588
Simpson forceps obstetrico	602	Standard pinza de diseccion	81, 81/1	Thoms-Allis pinza intestinal	538
Simpson-Braun forceps obstetrico	602	STANDARD tijera para cirugia	51	Thomson-Walker separador vesical	552
Simpson-Luikart forceps obstetrico	603	STAUDE-MOORE pinza uterina	582	Thorax (Coryllios) separador	166
Sims curetas uterinas	597	Steinmann alambre	307, 308	Thorek tijera vesicula biliar	65/2
Sims depresor uterino	586	Steinmann pinza de agarre para tendones	292	Thudichum especulo nasal	421
Sims dilatador uterino	581	Stellbrink pinza gubia	234	Tieck-Halle especulo nasal	423
Sims especulo rectal	559	Sternberg separador para labios y mejillas	453		
Sims especulo vaginal	573	Stevens gancho para cristalino	375		
Sims histerometro	586	Stevens pinza para iris	383		
Sims tijera ginecologica	62	Stevens porta aguja	214		
Sims-Maier pinza porta-esponja	134	STEVENS tijera para tenotomia	58		
Singley pinza de diseccion	88	Stevens tijera supercut	72		

tijera auricular micro Bellucci.....	413, 417	tijera para ligadura Spencer.....	66	transformador para mango de pila para laringoscopio.....	34
tijera auricular micro Shea.....	413	tijera para neurocirugia.....	65	Travers separador.....	172
tijera corneal AEBLI.....	58	tijera para neurocirugia Strully.....	65	Trelat especulo vaginal.....	571
tijera cuticular.....	610	tijera para oftalmologia.....	57	trepano Keyes.....	608
tijera de diseccion DEEVER.....	52	tijera para oftalmologia.....	75, 79	trocar abdominal Standard (Nelson).....	204
tijera de diseccion JORGENSEN.....	53	tijera para oftalmologia Barraquer Colibri.....	75	trocar Douglas.....	204
tijera de diseccion LEXER.....	53	tijera para oftalmologia GRADLE.....	57	trocar Nelson.....	205
tijera de diseccion LEXER BABY.....	53	tijera para parametrium.....	63	trocar Ochsner.....	205
tijera de diseccion MAYO.....	52	tijera para preparacion.....	65	trocar para seno maxilar Coakley.....	204
tijera de diseccion MAYO-NOBLE.....	52	tijera para rinoplastia Fomon.....	65/1	trocar para seno maxilar Lichtwitz.....	204
tijera de diseccion MAYO-STILLE.....	52	tijera para septo Killian.....	471	trocar para seno maxilar Pierce.....	204
tijera de diseccion METZENBAUM.....	53/1	tijera para tendon Westcott.....	75	trocar para sinoscopia.....	205
tijera de diseccion WELLER.....	53/2	tijera para tenotomia STEVENS.....	58	trocar Universal.....	204
tijera de incision.....	52	tijera para uñas.....	609, 614	Troeltsch (Wilde) pinza auricular.....	410
tijera DeBakey.....	60	tijera para vasija Klinkenbergh-Loth.....	65/2	Troeltsch pinza nasal.....	424
tijera duramadre Schmieden-Taylor.....	65/1	tijera para vendaje.....	69/1, 69/2, 70	TROEMNER martillo de percusion.....	24
tijera ENUCLEATION.....	58	tijera para vendaje Bergmann.....	69/1	Trousseau-Baby dilatador traqueal.....	476
tijera face lift Freeman.....	73	tijera para vendaje Bruns.....	70	Trotman (Colibri) pinza para iris.....	384
tijera face lift Gorney.....	73	tijera para vendaje Esmarch.....	69/2	Trotman pinza para iris.....	389
tijera face lift Kaye.....	73	tijera para vendaje Knowles.....	70	TROUTMAN-CHRIS.....	45
tijera face lift Peck Joseph.....	73	tijera para vendaje Lister.....	69/1	Tubbs dilatador de aorta.....	528
tijera face lift Rees.....	73	tijera para vendaje Lorenz.....	70	Tübingen pinza para ligadura.....	392
tijera ginecologica Doyen.....	63	tijera para vendaje REDA Excenter.....	69/2	Tübingen pinza para sutura.....	386
tijera ginecologica Dubois.....	63	tijera para vendaje Seutin.....	69/2	tubo de aspiracion.....	337, 337/1, 337/2, 338
tijera ginecologica Siebold.....	62	tijera para vendaje Universal.....	70	tubo de aspiracion Adson.....	337
tijera ginecologica SIMS.....	62	tijera para vesicula biliar Thorek.....	65/2	tubo de aspiracion ANDREW-PYNCHON.....	28
tijera ginecologica Wertheim.....	63	tijera pulmonares Crafoord.....	65/2	tubo de aspiracion BABY-YANKAUER.....	27
tijera Martin-Cartilage.....	65/1	tijera STRABISMUS.....	58	tubo de aspiracion COOLEY.....	28
tijera nasal.....	428, 429	tijera supercut Baby Metzenbaum.....	71	tubo de aspiracion Fergusson.....	337
tijera nasal COTTLE.....	59	tijera supercut Iris.....	72	tubo de aspiracion Frazier/Fergusson.....	337
tijera nasal FOMON.....	58	tijera supercut Kilner/Ragnell.....	72	tubo de aspiracion House.....	337/2
tijera nasal HEYMANN.....	58	tijera supercut La Grange.....	72	tubo de aspiracion Plester.....	338
tijera nasal Watson-Williams.....	428	tijera supercut Lister.....	72	tubo de aspiracion POOLE.....	27
tijera Northbent.....	66	tijera supercut Mayo.....	71	tubo de aspiracion Rosen.....	338
tijera para alambre y laminas Universal.....	67	tijera supercut Mayo-Stille.....	71	tubo de aspiracion Yasargil.....	337/1
tijera para amigdalas.....	59	tijera supercut Metzenbaum.....	71	tubo de aspiracion Zöllner.....	337/1
tijera para amigdalas BOETTCHER.....	59	tijera supercut Reynolds.....	72	tubo de extension Bruenings.....	472
tijera para amigdalas DEAN.....	59	tijera supercut Stevens.....	72	tubos de aspiracion YANKAUER.....	27
tijera para amigdalas GOOD.....	59	tijera supercut Wagner.....	72	Tuffier pinza hemostatica.....	110
tijera para capsula RESANO.....	53/2	tijera Toennis-Adson.....	65	Tuffier separador.....	147
tijera para cartilago McIndoe.....	65/1	tijera vascular DeBakey.....	61	Tuffier separador costal.....	487
tijera para cirugia COTTLE.....	56	tijera vascular DIETRICH.....	60	Turnbull alicate para cortar uñas.....	609
tijera para cirugia GRAEFFE.....	56	tijera vascular Favaloro.....	61	Turrel pinza para biopsia rectal.....	567
tijera para cirugia IRIS.....	54	tijera vascular Kelly.....	61	Tyding amigdalotomo.....	469
tijera para cirugia JOSEPH.....	54	tijera vascular POTTS DE MARTEL.....	59	Tyding pinza para coger amigdalas.....	468
tijera para cirugia KILNER.....	54	tijera vascular Potts-Smith.....	61		
tijera para cirugia LITTLER.....	55	tijera vasija Satinsky.....	65/2	U	
tijera para cirugia METZENBAUM.....	54	tijera Wagner.....	67	U.S. Kirschner estribo para extension.....	312
tijera para cirugia REYNOLDS.....	54	tijeras para cirugia KNAPP.....	55	Uckermann porta-algodon.....	203
tijera para cirugia SANVERNERO.....	54	tijeras Supercut.....	71, 72	Ulrich pinza para hueso.....	248
tijera para cirugia STANDARD.....	51	tijeras vasculares.....	59	Ulrich pinza para tapones.....	135
tijera para cirugia Systrunk.....	66	Tilley pinza auricular.....	411	UNI I estuche de diagnostico / otoscopio.....	13
tijera para cirugia Waldmann.....	64	tirabuzon para fibroma Doyen.....	594	UNI II estuche de diagnostico/ oftalmoscopio May.....	14
tijera para cordon umbilical Busch.....	64	Tischler-Down pinza para biopsia.....	591	UNI III estuche de diagnostico.....	15
tijera para cordon umbilical Mod. USA.....	64	Tischler-Kevoorkian pinza para biopsia.....	592	Universal pinza para esterilizacion.....	227
tijera para cordon umbilical Schuhmacher.....	64	Tischler-Morgan pinza para biopsia.....	590, 591	Universal tijera para alambre y laminas.....	67
tijera para corneales Castroviejo.....	79	Tischler-Up pinza para biopsia.....	591	Universal tijera para vendaje.....	70
tijera para coronas Beebeee.....	68	Tobold baja-lengua.....	453	Universal trocar.....	204
tijera para encias Goldman-Fox.....	67	Tobold porta-algodon.....	203	Unna saca comedones.....	608
tijera para encias La Grange.....	69	Toennis elevador para duramadre.....	332	uretrotomo Otis.....	553
tijera para encias Locklin.....	69	Toennis pinza hemostatica.....	117	US Army / Parker-Langenbeck separador.....	141
tijera para encias Quinby.....	67	Toennis-Adson tijera.....	65	USA Mod. tijera para cordon umbilical.....	64
tijera para enterotomo.....	66	Tohoku pinza de campo.....	132	USA pinza de diseccion.....	81, 81/1
tijera para episiotomia Braun-Stadler.....	64	tonometro Schioetz.....	394/2		
tijera para esternon Schumacher.....	481	Took cuchillo corneal.....	373	V	
tijera para gaza Smith Us Army.....	69/1	torneque pneumatico.....	295	V. Petz aparato para suturar estomago y intestinos.....	549
tijera para intestino Fergusson.....	66	tourneque Rumel-Belmont.....	528	vaina para tornillos.....	324
tijera para iridectomia Castroviejo.....	79	TOWNLEY calibre.....	26	Valleix histerometro.....	586
tijera para iridectomia Vannas.....	79	Townsend pinza para biopsia.....	591	Van Buren buja dilatadora.....	554
tijera para iris Noyes.....	75	Toynbee especulo auricular.....	399	Van Buren pinza para secuestros.....	249
tijera para iris Wecker.....	75	tractor Barton.....	603	van Doren pinza para biopsia.....	588
tijera para ligadura Heath.....	66	tractor Bill.....	604	Vannas tijera para iridectomia.....	79
tijera para ligadura Littauer.....	66	tractor Luikart-Bill.....	604	Vardy instrumento para varices.....	202

vasos graduados	621	Williger periostotomo	276
vendaje de compresion Esmarch	296	Winter pinza para aborto	606
Verbrugge pinza para hueso	245	Wittner pinza para biopsia	589
Verbrugge-Müller elevador	286/2	Wolff pinza para arrancar vendaje enyesado	233
Verres aguja para neumoperitoneo	206	Woodson elevador para duramadre	333
Vienna especulo nasal	421	Worst sonda lacrimal	381
Vienna sonda conductora	221	Wrigley forceps obstetrico	602
VIRCHOW cuchillo para autopsia	48	Wullstein cuchillo	418
VIRCHOW cuchillo para cerebro	48	Wullstein mango de aspiracion	338
Virtus (RALK) pinza para espinas	92	Wullstein pinza auricular micro	416
Volkman cucharella cortante	251, 257	Wullstein separador	171
Volkman separador	153, 154, 156	Wylie dilatador uterino	581
Voitolini especulo nasal	421		
Vu-More especula vaginal	569	Y	
		Yancoskie separador	198
W		Yankauer elevador para amigdalas	465
Wachenfeldt pinza para aplicar agrafes	224	YANKAUER tubo de aspiracion	27
Wadsworth-Todd cauterio	378	Yasargil clips para aneurisma	345-356
Wagener gancho abotonado	409	Yasargil gancho para galea	330
Wagener-Mosher canula para traqueotomia	477	Yasargil pinza para tumores	97
Wagner pinza cortante para laminectomia	343	Yasargil tubo de aspiracion	337/1
Wagner tijera	67	Yeoman cierra-nudo rectal	566
Wagner tijera supercut	72	Yeoman pinza para biopsia rectal	566, 567
Waldmann tijera para cirugía	64	Young Boomerang aguja	220
Wallich cucharella para aborto	607	Young Boomerang porta aguja	220
Walsham pinza para enderezar el tabique nasal	449	Young pinza de agarre para prostata	550
Walton gubia para cuerpos extraños	374	Young pinza tira-lengua	453
Walton saca comedones	608	Young separador prostatico	550
Walton sierra para abrir anillos	297		
Wangensteen pinza de diseccion	89	Z	
Wangensteen porta aguja	210	Zaufal elevador auricular	409
WARTENBERG sensimetro	25	Zaufal-Jansen elevador auricular	409
WATSON dermatomo	50	Zaufal-Jansen pinza gubia	238
Watson-Cheyne disecador	199	Zenker pinza hemostatica	118
Watson-Cheyne elevador	283	Zenker separador	161
Watson-Williams pinza nasal	428	Ziegler blefarostato	371
Waugh pinza de diseccion	83	Ziegler cuchillo para discision	373
Weber asa	378	Ziegler cuchillo para iris	372
Weber pinza para la aorta	501	Ziegler dilatador lacrimal	381
Webster porta aguja	208	ZIEGLER espejo frontal	21
Wecker espátula para iris	378	Zielke gubia	264
Wecker tijera para iris	75	Zöliner tubo de aspiracion	337/1
Week blefarostato	370		
Weil-Blakesley pinza nasal	426		
Weitlaner separador	169		
Weitlaner-Wullstein separador	169		
WELLER tijera de diseccion	53/2		
Wells espátula para enucleacion	378		
Wertheim pinza para histerectomia	124, 128		
Wertheim tijera ginecologica	63		
Wertheim-Cullen pinza para histerectomia	125		
West cincel nasal	442/1		
Westcott tijera para tendon	75		
Westmacott pinza nasal	424		
Wheeler cuchillo para discision	373		
Wheeler espátula para ciclodialisis	379		
White pinza para coger amigdalas	467		
Wieder baja-lengua	452		
Wiener escofina nasal	443		
Wiener gancho para iris	375		
Wigmore cuchillo para vendajes enyesados	229		
Wikstroem pinza hemostatica	117		
Wilde (Troeltsch) pinza auricular	410		
Wilde cierra-nudo auricular	411		
Wilde polipotomo	433/2		
Wiider asa	378		
Wiider dilatador lacrimal	381		
Williams destornillador	323		
Willet Martel pinza hemostatica	110		
Williams blefarostato	370		
Williams pinza para tejido	539		
Williger cucharella cortante	255, 257		
Williger martillo	271		

ADENOTOMO LA FORCE.....	450	AGO, KOENIG.....	223	AXENFELD CURETTA DA CALAZIO.....	377
AGRAFES, MICHEL.....	224	AGO, REVERDIN.....	220	AYER PINZA PER CALAZIO.....	393
ABBASSALINGUA.....	451	AGO, ROSEN.....	419		
ABBASSALINGUA DAVIS-BOYLE.....	455	AGO, YOUNG-BOOMERANG.....	220	B	
ABBASSALINGUA DOUGHTY.....	458	ALAN-PARKS DIVARICATORE ANALE.....	561	BABCOCK PINZA PER AFFERRARE INTESTINI.....	539
ABBASSALINGUA RUSSEL-DAVIS.....	458	ALDERDYCE ELEVATORE.....	282	BABINSKI MARTELLO DA PERCUSSIONE.....	24
ABBASSALINGUA, ANDREW.....	452	ALESATORE PER FEMORE, KUENTSCHER.....	321	BABY BURKE PINZA PER BIOPSIA.....	590
ABBASSALINGUA, BRUENINGS.....	451	ALESATORE PER L'APERTURA DEL MIDOLLO, KUENTSCHER.....	321	BABY GOSSET DIVARICATORE ADDOMINALE.....	181
ABBASSALINGUA, BUCHWALD.....	451	ALEXANDER PERIOTOTOMO.....	276	BABY METZENBAUM SUPERCUT FORBICI.....	71
ABBASSALINGUA, DINGMANN.....	456	ALEXANDER PINZA PER BIOPSIA.....	589	BABY TISCHLER PINZA PER BIOPSIA.....	592
ABBASSALINGUA, FRENZEL.....	451	ALEXANDER SCALPELLO.....	259	BABY WEBSTER PORT'AGHI.....	208
ABBASSALINGUA, HARTMANN.....	452	ALEXANDER SGORBIA.....	259	BABY YANKAUER CANNULA D'ASPIRAZIONE.....	27
ABBASSALINGUA, KILNER-DOUGHTY.....	456	ALGESIMETRO, WARTENBERG.....	25	BABY-KOCHER PINZA INTESTINALE.....	540
ABBASSALINGUA, KROENIG.....	451	ALLEN PINZA PER L'APPENDICE.....	544	BABY-OLSEN-HEGAR PORT'AGHI.....	212
ABBASSALINGUA, MAYO.....	451	ALLIS PINZA PER AFFERRARE INTESTINI.....	537	BABYPHON SFGIMOMANOMETRO.....	10
ABBASSALINGUA, MORITZ-SCHMIDT.....	452	ALLIS-ADAIR PINZA PER AFFERRARE INTESTINI.....	537	BACINELLA.....	619, 620
ABBASSALINGUA, TOBOLD.....	453	ALLIS-BABY PINZA PER AFFERARE INTESTINI.....	537	BACINELLA PER PLACENTA.....	621
ABBASSALINGUA, WIEDER.....	452	ALLISON SPATOLA PER POLMONE.....	489	BACINELLA RENIFORMA.....	619
ABRAHAM COLTELLO PER TONSILLE.....	466	ALM DIVARICATORE.....	168	BAKES DILATATORE BILIARE.....	532
ABRAHAM PINZA PER TONSILLE.....	468	ALVIS CURETTA PER CORPI ESTRANEI.....	374	BAILEY APPROSSIMATORE COSTALE.....	489
ACCESSORI DI FISSAZIONE, ANELLI E BARRE.....	195	AMNIOSCOPO.....	601	BAILEY-BABY APPROSSIMATORE COSTALE.....	489
ACCESSORI PER SEGA PER AUTOPSIA.....	231/2, 231/3	AMNIOTOMO, BEACHAM.....	586	BAILEY-GIBBON APPROSSIMATORE COSTALE.....	489
ADATTATORE DI ILLUMINAZIONE.....	601	ANDERSON ADSON DIVARICATORE.....	172	BAINBRIDGE PINZA EMOSTATICA.....	119/2
ADLERKREUTZ PINZA VASCOLARE.....	84	ANDREW ABBASSALINGUA.....	452	BAINBRIDGE PINZA VASCOLARE.....	495
ADSON DIVARICATORE.....	173	ANDREW-PYNCHON TUBO D'ASPIRAZIONE.....	28	BALFOUR DIVARICATORE ADDOMINALE.....	182
ADSON PINZA ANATOMICA.....	82	ANELLI DI GOMMA PER LEGATURA.....	568	BALFOUR DIVARICATORE ADDOMINALE.....	183
ADSON PINZA ANATOMICA.....	82	ANOSCOPO, HIRSCHMANN.....	562	BALFOUR-US DIVARICATORE ADDOMINALE.....	184
ADSON PINZA CHIRURGICA.....	82	ANSA AURICOLARE, BILLEAU.....	409	BALL AND SOCKET PINZA FISSATELI.....	133
ADSON BABY PINZA EMOSTATICA.....	113	ANSA AURICOLARE, SHAPLEIGH.....	410	BALLENGER COLTELLO PER SETTO.....	436
ADSON DIVARICATORE.....	172	ANSA PER CATERATTA, ARLT.....	378	BALLENGER ELEVATORE PER SETTO.....	439
ADSON MICRO PINZA ANATOMICA.....	82	ANSA PER CATERATTA, SNELLEN.....	378	BALLENGER PINZA PER TONSILLE.....	467
ADSON MICRO PINZA CHIRURGICA.....	82	ANSA PER CATERATTA, WEBER.....	378	BANE-HARTMANN PINZA SGORBIA.....	237
ADSON PERIOTOTOMO.....	282	ANSA PER CATERATTA, WILDER.....	378	BANGERTER SPATOLA PER CICLODIALISI.....	379
ADSON PINZA EMOSTATICA.....	112	ANSA PER POLIPI.....	411	BARACANI INSERTO.....	472
ADSON PINZA PER IPOFISI.....	334	ANSE PER TONSILLE.....	468	BARANY ASSORDITORE.....	405
ADSON PINZA SGORBIA.....	236	ANTRUM-CURETTA.....	435	BARBARA AGO.....	419
ADSON PORT'AGHI.....	211	ANVIL TRONCHESINA PER UNGHIE.....	613	BARBARA UNCINO.....	419
ADSON TENAGLIA PER OSSA.....	298	APPARECCHIATURA DI SUTURA GASTRO-INTESTINALE, V.PETZ.....	549	BARKAN COLTELLO PER GONIOTOMIA.....	373
ADSON TUBO D'ASPIRAZIONE.....	337	APPROSSIMATORE COSTALE, BAILEY.....	489	BARNHILL COLTELLO ADENOIDE.....	450
ADSON UNCINO PER DURAMADRE.....	329	APPROSSIMATORE COSTALE, BAILEY-BABY.....	489	BARON CANNULA D'ASPIRAZIONE.....	336
ADSON, DIVARICATORE.....	174	APPROSSIMATORE COSTALE, BAILEY-GIBBON.....	489	BARR SPECOLO RETTALE.....	559
ADSON-BROWN PINZA CHIRURGICA.....	82	APPROSSIMATORE, BIEMER.....	366	BARRAQUER (COLIBRI) PINZA PER IRIDE.....	384
AEBLI FORBICI PER OFTALMOLOGIA.....	58	APPROSSIMATORE, BIEMER-MÜLLER.....	363	BARRAQUER BLEFAROSTATO.....	370
AGHI PER SUTURE.....	222, 223	APRIBOCCA DI LEGNO MAUNDER.....	459	BARRAQUER COLTELLO PER CHERATOPLASTICA.....	373
AGO PER BIOPSIA,FRANKLIN-SILVER.....	206	APRIBOCCA, DAVIS-BOYLE.....	455	BARRAQUER FORBICI OCULISTICHE.....	75
AGO DI GUIDA, IOWA.....	206	APRIBOCCA, DAVIS-MEYER.....	457	BARRAQUER PINZA DA FISSAZIONE.....	390
AGO DI GUIDA, REDON.....	207	APRIBOCCA, DENHART,12CM.....	454	BARRAQUER PINZA DEPILETORIA.....	395
AGO DI INTRODUZIONE, OBWEGESER.....	463	APRIBOCCA, DINGMANN.....	456	BARRAQUER PORT'AGHI.....	216, 217
AGO DI INTRODUZIONE, OBWEGESER.....	463/3	APRIBOCCA, HEISTER.....	454	BARRAQUER-KATZIN PINZA PER IRIDE.....	384
AGO PASSAFILI, DEMEL.....	315	APRIBOCCA, JENNINGS.....	454	BARRAQUER-TROUTMAN PORT'AGHI.....	216
AGO PER CORPI ESTRANEI.....	374	APRIBOCCA, KILNER-DOUGHTY.....	456	BARRET PINZA PER ABBASSARE IL COLLO DELL'UTERO.....	582
AGO PER CORPI ESTRANEI, DAVIS.....	374	APRIBOCCA, MCIVOR.....	457	BARTON FORCIPE.....	603
AGO PER CORPI ESTRANEI, FRANCIS.....	374	APRIBOCCA, ROSER-KOENIG 16CM.....	454	BARTON TRATTORE.....	603
AGO PER CORPI ESTRANEI, LA FORCE.....	374	APRIBOCCA,DOYEN-JANSEN(MOLT).....	454	BAUMGARTNER PORT'AGHI.....	208
AGO PER CORPI ESTRANEI, LEVINSON.....	374	ARCHER PINZA PER SCHEGGE.....	92	BEACHAM AMNIOTOMO.....	586
AGO PER DISCISIONE.....	374	ARCO PER ESTENSIONE, BOEHLER.....	312	BECHERT ROTATORE PER NUCLEO.....	379
AGO PER DISCISIONE, BOWMAN.....	374	ARCO PER ESTENSIONE, KIRSCHNER.....	312	BECK PINZA PER ANASTOMOSI.....	520
AGO PER INSUFFLAZIONE, VERESS.....	206	ARCO PER ESTENSIONE, KIRSCHNER US.....	312	BECK PINZA VASCOLARI.....	516
AGO PER LEGATURE.....	218	ARLT ANSA PER CATERATTA.....	378	BECKER CISTOTOMO.....	375
AGO PER LEGATURE SCHMIEDEN-DICK.....	219	ARRUGA BLEFAROSTATO.....	370	BECKMANN COLTELLO ADENOIDE.....	450
AGO PER LEGATURE, COOPER.....	219	ARRUGA CUCCHIAIO PER ASPORTAZIONE RETINALE.....	378	BECKMANN DIVARICATORE.....	176
AGO PER LEGATURE, DESCHAMPS.....	218	ARRUGA PINZA CAPSULARE.....	391	BECKMANN-ADSON DIVARICATORE.....	175
AGO PER LEGATURE, KRONECKER.....	219	ARRUGA PORT'AGHI.....	214	BECKMANN-EATON DIVARICATORE.....	176
AGO PER LEGATURE, NELSON.....	219	ARRUGA UNCINO ESTRATTORE.....	375	BEEBEE FORBICI PER CORONA.....	68
AGO PER PARACENTESI, LUCAE.....	408	ASCH PINZA PER LA PLASTICA NASALE.....	449	BEER PINZA DEPILETORIA.....	395
AGO PER PARACENTESI, POLITZER.....	408	ASSORDITORE, BARANY.....	405	BEESON DIVARICATORE PER GESSI.....	232
AGO PER TONSILLE.....	470	AUFRANC-COBRA DIVARICATORE.....	289	BEESON DIVARICATORE PER GESSI.....	232
AGO PER TONSILLE, CLAU.....	466	AUFRIKHT RASPA NASALE.....	443	BELLUCCI MICRO FORBICI AURICOLARI.....	413
AGO PER TONSILLE, DUPUY-WEISS.....	466	AUFRIKHT UNCINO NASALE.....	447	BELLUCCI MICRO FORBICINE.....	417
AGO PER TONSILLE, NAGER.....	466	AUVARD SPECOLO VAGINALE.....	576	BENDA PER COMPRESIONE ESMARCH.....	297
AGO POST MORTEM.....	268				
AGO, BARBARA.....	419				
AGO, KEITH.....	223				

BENDER MODELLATORE PER CHIODI.....322
BENGOLEA PINZA EMOSTATICA.....112
BENNETT ELEVATORE PER OSSA.....283
BENSAUDE PROCTOSCOPO.....565
BENSON DIVARICATORE PER PILORO.....544
BERENS CERATOMO.....372
BERGMANN FORBICI PER BENDAGGI.....69/1
BERGMANN MARTELLO.....272
BERKE PINZA MUSCOLARE.....389
BERLINER MARTELLO DA PERCUSSIONE.....24
BERNHARD PINZA FISSATELI.....133
BERRY PINZA TORCIFILI.....319
BETHUNE COSTOTOMO.....481
BICCHIERE GRADUATO.....620
BICCHIERE PER MEDICINALI.....621
BIEMER APPROSSIMATORE.....366
BIEMER CLIPS PER VASI.....361
BIEMER PINZA POSA CLIPS.....361,363,364,366
BIEMER-MÜLLER APPROSSIMATOR.....363
BIER SEGA PER AMPUTAZIONE.....296
BILL TRATTORE.....604
BILLEAU ANSA AURICOLARE.....409
BIRCHER-GANSKE TENAGLIA PER OSSA.....246
BIRKETT PINZA EMOSTATICA.....116
BISHOP-HARMAN PINZA PER IRIDE.....386
BISHOP-HARMON CANNULA OCULISTICA PER IRRIGAZIONE ED ASPIRAZIONE.....394/1
BISTURI MONOUSO, STERILI.....43
BISTURI PER FIBROMI, SEGOND.....594
BISTURI, MANICO DI METALLO.....46
BLAKE CURETTA UTERINA.....595
BLAKE PINZA PER CALCOLI BILIARI.....531
BLEFAROSTATO CLARK.....370
BLEFAROSTATO LIEBERMANN.....371
BLEFAROSTATO, ARRUGA.....370
BLEFAROSTATO, BARRAQUER.....370
BLEFAROSTATO, BOWMAN.....370
BLEFAROSTATO, CASTROVIEJO.....371
BLEFAROSTATO, CRITCHETT.....370
BLEFAROSTATO, GRAEFE.....370
BLEFAROSTATO, LANCASTER.....371
BLEFAROSTATO, LISTER-BURCH.....370
BLEFAROSTATO, MELLINGER.....370
BLEFAROSTATO, MELLINGER-AXENFELD.....370
BLEFAROSTATO, MUELLER.....371
BLEFAROSTATO, MURDOCK.....370
BLEFAROSTATO, PARK.....371
BLEFAROSTATO, SMITH.....370
BLEFAROSTATO, STEVENSON.....371
BLEFAROSTATO, WEEK.....370
BLEFAROSTATO, WILLIAMS.....370
BLEFAROSTATO, ZIEGLER.....371
BLOHMKE PINZA PER TONSILLE.....467
BLOUNT ELEVATORE PER GINOCCHIO.....289
BLOUNT ELEVATORE PER OSSA.....288
BLUMENTHAL PINZA SGORBIA.....236
BODENHAMMER SPECOLO RETTALE.....559
BOEHLER ARCO PER ESTENSIONE.....312
BOERMA FORCIPE.....604
BOETTCHER FORBICI PER TONSILLE.....59
BÖHLER CESOIA PER OSSA.....241
BÖHLER PINZA SGORBIA.....238
BOIES ELEVATORE.....277
BONACCOLTO PINZA PER STRABISMO.....385
BONN PINZA PER IRIDE.....387
BONNEY PINZA ANATOMICA.....88
BONNEY PINZA CHIRURGICA.....88
BOSE DIVARICATORE TRACHEALE.....476
BOUCHERON SPECOLO AURICOLARE.....399
BOWMAN AGO PER DISCISIONE.....374
BOWMAN BLEFAROSTATO.....370
BOWMAN CERATOMO.....372
BOWMAN SPECILLO PER CANALE LACRIMALE.....381

BOYNTON PORT'AGHI.....214
BOZEMANN PINZA PER TAMPONI.....138
BOZEMANN PORT'AGHI.....211
BOZEMANN-DOUGLAS PINZA PER TAMPONI.....138
BRACCIALE.....295
BRACCIO PORTALARINGOSCOPIO KLEINSASSER.....36
BRAND ENUCLEATORE PER TENDINI.....294
BRAND STRUMENTI PER AFFERRARE TENDINI.....293
BRAUN CRANIOCLASTO.....607
BRAUN DEPRESSORE UTERINO.....586
BRAUN PINZA PER ABBASSARE IL COLLO DELL'UTERO.....582
BRAUN UNCINO SPEZZATORE.....607
BRAUN-STADLER FORBICI PER EPISIOTOMIA.....64
BREAST DIVARICATORE PER CHIRURGIA PLASTICA.....198
BREISKY SPECOLO VAGINALE.....577
BRIDGE PINZA EMOSTATICA.....116
BRISTOW ELEVATORE PER OSSA.....290
BRODIE SPECILLO.....199
BROPHY PINZA ANATOMICA.....84
BROPHY PINZA CHIRURGICA.....84
BROWN PINZA PER TESSUTI.....83
BROWN PORT'AGHI.....209
BRUENINGS COLTELLO PER TONSILLE.....466
BRUENINGS ABBASSALINGUA.....451
BRUENINGS INSERTO.....472
BRUENINGS PINZA PER SETTO NASALE.....425
BRUENINGS SPECOLO AURICOLARE.....401
BRUNETTI SCALPELLO.....288
BRÜNINGSG-LUCAS SCALPELLO.....260
BRÜNINGSG-LUCAS SCALPELLO.....260
BRÜNINGSG-LUCAS SGORBIA.....260
BRUNNER COSTOTOMO.....481
BRUNNER DIVARICATORE.....167
BRUNNER PINZA INTESTINALE.....543
BRUNNER SONDE CONDUITRICE.....221
BRUNNER SONDE CONDUITRICE.....221
BRUNS CURETTA TAGLIANTE.....251, 254
BRUNS FORBICI PER BENDAGGI.....70
BRYANT PINZA PER MEDICATURA.....137
BUCHWALD ABBASSALINGUA.....451
BUCK CURETTA AURICOLARE.....407
BUCK LEVA PER CORPI ESTRANEI.....412
BUCK MARTELLO DA PERCUSSIONE.....24
BUCK-GRAMCKO ELEVATORE PER OSSA.....285
BUIE CANNULA D'ASPIRAZIONE RETTALE.....566
BULLDOG PINZA MINI DIETRICH.....101
BULLDOG PINZA, JOHNS-HOPKINS.....104
BULLDOG PINZE ATRAUMATICHE.....100
BÜLOW-GUNAR-HEY PINZA SERRATUBI A RULLI.....130
BUMM CURETTE UTERINI.....597
BUNELL ENUCLEATORE PER TENDINI.....292
BUNELL GUIDA PER TENDINI.....294
BUNELL PERFORATORE A MANO.....299
BUNGE CUCCHIAIO PER ESTENTERAZIONE.....378
BUNT PINZA PER STERILIZZAZIONE.....227
BURCH UNCINO DI FISSAZIONE.....373
BURKE PINZA PER BIOPSIA.....590
BUSHE CURETTA TAGLIANTE.....256

C
CACCIIVITE WILLIAMS.....323
CACCIIVITE, LANE.....323, 324
CALAMITA OCULISTICA, REDA.....395
CALIBRO.....26
CAMERA D'ARIA.....295
CANDELETTA DILATATRICE, DITTEL.....554
CANDELETTA DILATATRICE, GUYON.....554
CANDELETTA DILATATRICE, VAN BUREN.....554
CANFIELD COLTELLO PER TONSILLE.....466
CANNULA DA INIEZIONE.....36
CANNULA D'ASPIRAZIONE.....337/1
CANNULA D'ASPIRAZIONE KLEINSASSER.....36

CANNULA D'ASPIRAZIONE PER BIOPSIA, BUIE.....566
CANNULA D'ASPIRAZIONE POOLE.....27
CANNULA D'ASPIRAZIONE ZÖLLNER.....337/1
CANNULA D'ASPIRAZIONE, ADSON.....337
CANNULA D'ASPIRAZIONE, ANDREW-PYNCHON.....28
CANNULA D'ASPIRAZIONE, BABY-YANKAUER.....27
CANNULA D'ASPIRAZIONE, COOLEY.....28
CANNULA D'ASPIRAZIONE, DE BAKEY.....28
CANNULA D'ASPIRAZIONE, FERGUSON.....337
CANNULA D'ASPIRAZIONE, FERGIER/FERGUSON.....337
CANNULA D'ASPIRAZIONE, PLESTER.....338
CANNULA D'ASPIRAZIONE, ROSEN.....338
CANNULA D'ASPIRAZIONE, YASARGIL.....337/1
CANNULA D'ASPIRAZIONE, HOUSE.....337/2
CANNULA LARINGEA.....470
CANNULA OCULISTICA JENSEN.....394
CANNULA OCULISTICA MCINTYRE.....394
CANNULA OCULISTICA PER IRRIGAZIONE ED ASPIRAZIONE BISHOP-HARMON.....394/1
CANNULA OCULISTICA, LACRIMAL.....394
CANNULA PER ASPIRAZIONE GUILLEN.....433/1
CANNULA PER BIOPSIA, MENGHINI.....206
CANNULA PER IRRIGAZIONE KILLIAN.....433, 433/1
CANNULA PER IRRIGAZIONE SHEETS.....394/2
CANNULA PER IRRIGAZIONE, HARTMANN.....433
CANNULA PER IRRIGAZIONE, SCHMID.....338
CANNULA PER IRRIGAZIONE, SIEBENMANN.....433
CANNULA PER IRRIGAZIONE, SIMCOE.....394
CANNULA TRACHEALE, LUER.....479
CANNULA TRACHEALE, WAGENER-MOSHER.....477
CANNULA TRACHEALE,CHEVALIER-JACK.....479
CANNULA, LICHTWITZ.....433
CAPLAN PINZA NASALE.....428
CARMLAT PINZA PER SCHEGGE.....91
CAROLL PINZA PER AFFERRARE TENDINI.....293
CARPENTER COLTELLO PER TONSILLE.....465
CASPAR DIVARICATORE PER SPINA CERVICALE.....179
CASPAR DIVARICATORE PER SPINA CERVICALE.....180
CASPAR PISTONI.....258
CASTANEDA NEONATAL PINZA VASCOLARE.....527
CASTROVIEJO BLEFAROSTATO.....371
CASTROVIEJO COLTELLO LANCEOLARE.....372
CASTROVIEJO COMPASSO.....380
CASTROVIEJO FORBICI CORNEALI.....79
CASTROVIEJO PINZA CAPSULARE.....391
CASTROVIEJO PINZA FISSATRICE.....390
CASTROVIEJO PINZA PER SUTURA.....392
CASTROVIEJO PORT'AGHI.....215
CASTROVIEJO ROMPIAMETTE.....45
CASTROVIEJO SPATOLA PER CICLODIALISI.....379
CASTROVIEJO-MICRO PORT'AGHI.....215
CASTROVIEJO-STANDARD PORT'AGHI.....216
CATETERE AURICOLARE, HARTMANN.....408
CATETERE METALLICO.....555
CATETERE METALLICO, COXETER.....555
CATLIN AMPUTATIONSMESN.....44
CAUTERIO WADSWORTH-TODD.....378
CAVO BIPOLORE.....633
CESOIA PER GESSI, STILLE.....229
CESOIA PER OSSA STILLE-HORSLEY.....242
CESOIA PER OSSA STILLE-LISTON.....242
CESOIA PER OSSA, BOEHLER.....241
CESOIA PER OSSA, LISTON.....241
CESOIA PER OSSA, MCINDOE.....241
CESOIA PER OSSA, RUSKIN-LISTON.....241
CESOIA PER OSSA, SEMB.....242
CESOIA PER OSSA,COTTLE-K.....241
CESTELLO.....623
CESTELLO PER ENDOSCOPI.....623
CESTELLO PER STERILIZZAZIONE.....622
HANDLER ELEVATORE.....282
CHAPUT PINZA PER AFFERRARE TESSUTI.....110
CHARNLEY DIVARICATORE ADDOMINALE.....289

CHARRIERE SEGA PER AMPUTAZIONE.....296	COLTELLO PER AMPUTAZIONE, CATLIN.....44	CORONAL BLOW DIVARICATORE PER CHIRURGIA PLASTICA.....198
CHEATLE PINZA PER STERILIZZAZIONE.....227	COLTELLO PER AMPUTAZIONE, LANGENBECK.....44	CORWIN-HEGAR PINZA TORCIFILI.....319
CHELSEA-EATON PROCTOSCOPO.....563	COLTELLO PER AMPUTAZIONE, REDA.....44	CORYLLOS COSTOTOMO.....480
CHERON PINZA PER MEDICATURA.....137	COLTELLO PER CARTILAGINE E DISSEZIONE, VIRCHOW.....48	CORYLLOS DIVARICATORE.....166
CHERRY DIVARICATORE PER LAMINECTOMIA.....488	COLTELLO PER CARTILAGINI, LANGENBECK.....47	COS MIKRO-PINZA AURICOLARE.....414
CHEVALIER-JACKSON CANNULA TRACHEALE.....479	COLTELLO PER CATARATTA, DEUTSCHMANN.....371	COSCIALE.....295
CHEVALIER-JACKSON PINZA PER BRONCO-ESOFAGOSOFIA.....473	COLTELLO PER CATARATTA, GRAEFE.....371	COSTOTOMO.....480
CHIAVE.....266	COLTELLO PER CERVELLO.....48	COSTOTOMO SAUERBRUCH-FREY.....481
CHIAVI.....313	COLTELLO PER CHERATOPLASTICA, BARRAQUER.....373	COSTOTOMO, BETHUNE.....481
CHILDE PINZA PER AGRAFES.....224	COLTELLO PER CHERATOPLASTICA, PAUFIQUE.....373	COSTOTOMO, BRUNNER.....481
CHIODI PER OSSA.....309	COLTELLO PER DURA MADRE, KOOS.....335	COSTOTOMO, CORYLLOS.....480
CHIODI STEINMANN.....307, 308	COLTELLO PER FALANGI.....44	COSTOTOMO, GIERTZ-STILLE.....481
CINELLI SCALPELLO PER SETTO.....441	COLTELLO PER GESSI, ESMARCH.....233	COSTOTOMO, GLUCK.....480
CISTOTOMO, BECKER.....375	COLTELLO PER GESSI, HOPKINS.....233	COSTOTOMO, SAUERBRUCH.....481
CISTOTOMO, GRAEFE.....375	COLTELLO PER GESSI, REINER.....233	COSTOTOMO, STILLE.....480
CITELLI PINZA TAGLIANTE PER SETTO NASALE.....430	COLTELLO PER GESSI, WIGMORE.....229	COTTLE COLUMELLA PINZA.....448
CLAR LAMPADA FRONTALE.....22	COLTELLO PER GONIOTOMIA, BARKAN.....373	COTTLE BULLDOG-FORBICI.....56
CLARK BLEFAROSTATO 8CM.....370	COLTELLO PER GONIOTOMIA, SCHEIE.....373	COTTLE COLTELLO NASALE.....435
CLAUS AGO PER TONSILLE.....466	COLTELLO PER IRIDE, DEAN.....372	COTTLE ELEVATORE PER SETTO.....439
CLAYMAN UNCINO.....376	COLTELLO PER IRIDE, KNAPP.....372	COTTLE FORBICI NASALI.....59
CLEVELAND PINZA SGOBIA.....235	COLTELLO PER IRIDE, ZIEGLER.....372	COTTLE MARTELLO.....273
CLIPS PER ANEURISMA YASARGIL.....345-356	COLTELLO PER MENISCO, NEFF.....292	COTTLE PINZA DA PRESA.....410
CLIPS PER VASI, BIEMER.....361	COLTELLO PER MENISCO, SMILLIE.....292	COTTLE SCALPELLO PER SETTO.....440
CLIPS PER VASI, MEHDORN.....362	COLTELLO PER ORGANI.....48	COTTLE SPECOLO NASALE.....423
CLIPS PER VASI, MUELLER.....364, 365	COLTELLO PER PERIOSTIO CON RASCHINO.....47	COTTLE UNCINO NASALE.....447
CLOWARD DIVARICATORE.....178	COLTELLO PER RESEZIONE.....47	COTTLE-JOSEPH ELEVATORE PER SETTO.....439
CLOWARD DIVARICATORE PER CORPI VERTEBRALI.....339	COLTELLO PER SETTO NASALE, FREER.....434	COTTLE-KAZANJIAN CESOIA PER OSSA.....241
CLOWARD PINZA TAGLIANTE PER LAMINECTOMIA.....342	COLTELLO PER SETTO, BALLENGER.....436	COTTLE-NEIVERT UNCINO NASALE.....448
COAKLEY ANTRUM CURETTA.....449	COLTELLO PER TONSILLE, ABRAHAM.....466	COXETER CATERETTER METALLICO.....555
COAKLEY TREQUARTO PER SENO MASCELLARE.....204	COLTELLO PER TONSILLE, BRUENINGS.....466	CRAFOOD-SELLORS PINZA EMOSTATICA.....119
COBB CURETTA.....252	COLTELLO PER TONSILLE, CANFIELD.....466	CRAFOOD FORBICI POLMONARE.....65/2
COBB PERIOSTOTOMO.....280	COLTELLO PER TONSILLE, CARPENTER.....465	CRAFOOD PINZA EMOSTATICA.....118
COBB SGOBIA.....262	COLTELLO PER TONSILLE, DOUGLAS.....466	CRANIOCLASTO, BRAUN.....607
COLCLOUGH PINZA TAGLIANTE PER DISCHI INTERVERTEBRALI.....344/1	COLTELLO PER TONSILLE, FISHER.....466	CRANIOCLASTO, TARNIER.....607
COLLER-CRILE PINZA EMOSTATICA.....106	COLTELLO, PLESTER.....418	CREGO ELEVATORE.....282
COLLIER PELVIMETRO.....605	COLTELLO, ROSEN.....418	CRILE DIVARICATORE.....140
COLLIER PORT'AGHI.....208	COLTELLO, SCHUKNECHT.....418	CRILE PINZA EMOSTATICA.....107
COLLIN DINAMOMETRO.....25	COLTELLO, TABB.....418	CRILE PORT'AGHI.....213
COLLIN DIVARICATORE.....139	COLTELLO, WULLSTEIN.....418	CRILE UNCINO PER NERVI.....328
COLLIN DIVARICATORE ADDOMINALE.....189/1	COLUMELLA PINZA, COTTLE.....448	CRILE-MURRAY PORT'AGHI.....209
COLLIN DIVARICATORE ADDOMINALE.....190	COLVER PINZA PER TONSILLE.....467	CRILE-RANKIN PINZA EMOSTATICA.....107
COLLIN ISTEROMETRO.....586	COMBINAZIONE PER DIAGNOSTICA CON ILLUMINAZIONE ALOGENA, RI-MINI.....17	CRILE-WOOD PORT'AGHI.....209
COLLIN LOKITTE DIVARICATORE ADDOMINALE.....191	COMBINAZIONE PER DIAGNOSTICA CON ILLUMINAZIONE STANDARD ECO "T".....16	CRITCHETT BLEFAROSTATO.....370
COLLIN MARTELLO.....270	COMBINAZIONE PER DIAGNOSTICA CON ILLUMINAZIONE STANDARD UNI I.....13	CRUTCHFIELD PERFORATORE.....327
COLLIN PELVIMETRO.....605	COMBINAZIONE PER DIAGNOSTICA CON ILLUMINAZIONE STANDARD UNI II.....14	CRUTCHFIELD PINZA PER TRAZIONE CRANIALE.....327
COLLIN PINZA OMBELICALE.....605	COMBINAZIONE PER DIAGNOSTICA CON ILLUMINAZIONE STANDARD UNI III.....15	CUCCHIAIO AURICOLARE, GROSS.....409
COLLIN PINZA PER AFFERRARE INTESTINI.....539	COMPASSO, CASTROVIEJO.....380	CUCCHIAIO OSTETRICO, SELLHEIM.....607
COLLIN PINZA PER AFFERRARE L'UTERO.....585	COMPASSO, IWANSON.....624	CUCCHIAIO PER ABORTO, CUZZI.....606
COLLIN PINZA PER AFFERRARE TESSUTI.....110	COMPRESSORE STONE-WATT.....545	CUCCHIAIO PER ABORTO, WALLICH.....607
COLLIN PINZA PER AGRAFES.....224	CONE PINZA PER CRANIOTOMIA.....331	CUCCHIAIO PER ASPORTAZIONE RETINALE, ARRUGA.....378
COLLIN PINZA PER MEDICATURA.....137	CONNIN-AMSLER MARCATORE.....380	CUCCHIAIO PER CALCOLI BILIARI MOOR.....532
COLLIN PINZA TIRILINGUA.....453	CONVERSE COLTELLO NASALE.....435	CUCCHIAIO PER CALCOLI BILIARI, DESJARDINS.....534
COLLIN SPECOLO VAGINALE.....570	COOLEY DILATATORE.....528	CUCCHIAIO PER CALCOLI BILIARI, FERGUSSON.....533
COLLIN-DUVAL PINZA DA PRESA.....85	COOLEY CANNULA D'ASPIRAZIONE.....28	CUCCHIAIO PER CALCOLI BILIARI, LUER-KOERTE.....533
COLLIN-HARTMANN DIVARICATORE.....141	COOLEY DIVARICATORE.....148	CUCCHIAIO PER CALCOLI BILIARI, MAYO.....534
COLTELLO ADENOIDE BECKMANN.....450	COOLEY DIVARICATORE COSTALE.....487	CUCCHIAIO PER CATERATTA, DAVIEL.....377
COLTELLO ADENOIDE, BARNHILL.....450	COOLEY PINZA CARDIOVASCOLARE ATRAUMATICA.....518, 519, 522	CUCCHIAIO PER CATERATTA, GRAEFE.....377
COLTELLO ADENOIDE, ST. CLAIR-THOMSON.....450	COOLEY PINZA PER CATETERI.....510	CUCCHIAIO PER CATERATTA, KNAPP.....378
COLTELLO AURICOLARE, POLITZER.....408	COOLEY-DERRA PINZA PER ANASTOMOSI.....519	CUCCHIAIO PER CATERATTA, WELLS.....378
COLTELLO AURICOLARE, SEXTON.....408	COOLEY-NEONATAL DIVARICATORE COSTALE.....485	CUCCHIAIO PER ESTENTERAZIONE, BUNGE.....378
COLTELLO FALCATO REDA.....435	COOPER AGO PER LEGATURE.....219	CUCCHIAIO PER MEDICINALI.....621
COLTELLO INTEROSSEO.....44	COPERCHIO PER PADELLA.....621	CUCCHIAIO PER SANGUE.....268
COLTELLO LANCEOLARE, BERENS.....372	CORDA DI TRAZIONE.....201	CUCCHIAIO UTERINO GOURDET.....599
COLTELLO LANCEOLARE, BOWMAN.....372	CORDES INSERTO.....472	CUCCHIAIO UTERINO SCHRÖDER.....595
COLTELLO LANCEOLARE, CASTROVIEJO.....372		CUCCHIAIO UTERINO, SIMON.....594
COLTELLO LANCEOLARE, JAEGER.....372		CULLER SPATOLA PER IRIDE.....378
COLTELLO LANCEOLARE, WHEELER.....373		CURETTA ANTRUM.....435
COLTELLO LANCEOLARE, ZIEGLER.....373		CURETTA ANTRUM, COAKLEY.....449
COLTELLO NASALE, CONVERSE.....435		CURETTA AURICOLARE, BUCK.....407
COLTELLO NASALE, COTTLE.....435		CURETTA COBB.....252
COLTELLO PER AMPUTAZIONE LISTON.....44		CURETTA DA CALAZIO, AXENFELD.....377

CURETTA DA CALAZIO, HEBRA377
 CURETTA DA CALAZIO, MEYHOEFER377
 CURETTA PER ABORTO, PESTALOZZA606
 CURETTA PER BIOPSIA ED ASPIRAZIONE600
 CURETTA PER BIOPSIA, HEANY587
 CURETTA PER BIOPSIA, KEVORKIAN587
 CURETTA PER BIOPSIA, MOD.MÜNCHEN587
 CURETTA PER BIOPSIA, NOVAK587
 CURETTA PER BIOPSIA, RANDALL587
 CURETTA PER CORPI ESTRANEI ALVIS374
 CURETTA PER IPOFISI334
 CURETTA PER LUPUS, FOX608
 CURETTA PER LUPUS, PIFFARD608
 CURETTA TAGLIANTE BRUNS251, 254
 CURETTA TAGLIANTE DOPPIA VOLKMANN257
 CURETTA TAGLIANTE VOLKMANN251
 CURETTA TAGLIANTE WILLIGER255
 CURETTA TAGLIANTE, BUSHE256
 CURETTA TAGLIANTE, DAUBENSPECK255
 CURETTA TAGLIANTE, HALLE253
 CURETTA TAGLIANTE, JACOBSON257
 CURETTA TAGLIANTE, JANSEN257
 CURETTA TAGLIANTE, LEMPERS256
 CURETTA TAGLIANTE, MARTINI257
 CURETTA TAGLIANTE, SCHEDE251
 CURETTA TAGLIANTE, SCOVILLE253
 CURETTA TAGLIANTE, SPINAL253
 CURETTA TAGLIANTE, SPRATT251
 CURETTA, FAULKNER449
 CURETTA, HOUSE420
 CURETTE UTERINI, BLAKE595
 CURETTE UTERINI, BUMM597
 CURETTE UTERINI, RECAMIER597
 CURETTE UTERINI, SIMS597, 598
 CURETTE UTERINI, THOMAS599
 CUSCO SPECOLO VAGINALE570, 571
 CUSHING (TAYLOR) PINZA TC87
 CUSHING DIVARICATORE151
 CUSHING DIVARICATORE152
 CUSHING DIVARICATORE153
 CUSHING PERFORATORE299
 CUSHING PINZA ANATOMICA83
 CUSHING PINZA CHIRURGICA83
 CUSHING PINZA TAGLIANTE PER LAMINECTOMIA340
 CUSHING SPATOLA CEREBRALE369
 CUSHING UNCINO PER NERVI328
 CUZZI CUCCHIAIO PER ABORTO606
 CZERNY PINZA PER ABBASSARE IL COLLO
 DELL'UTERO584
 CZERNY SPECOLO RETTALE559

D
 DANDY PINZA EMOSTATICA109
 DANDY UNCINO PER NERVI328
 DARLING DIVARICATORE178
 DARTIGUES PINZA PER AFFERRARE L'UTERO585
 DASTOOR PINZA PER STRABISMO386
 DAUBENSPECK CURETTA TAGLIANTE255
 DAVIDSON(SCAPULA) DIVARICATORE166
 DAVIEL CUCCHIAIO PER CATERATTA377
 DAVIS AGO PER CORPI ESTRANEI374
 DAVIS DURA DISSETTORE332
 DAVIS PINZA PER STERILIZZAZIONE227
 DAVIS SPATOLA CEREBRALE337
 DAVIS-BOYLE ABBASSALINGUA455
 DAVIS-BOYLE APRIBOCCA455
 DAVIS-MEYER APRIBOCCA457
 DAY UNCINO409
 DE BAKEY PINZE ATRAUMATICHE BULLDOG103
 DE BAKEY PINZE ATRAUMATICHE IN TITANIO99
 DE BAKEY CANNULA D'ASPIRAZIONE28
 DE BAKEY DILATATORE VASCOLARE529
 DE BAKEY DIVARICATORE ADDOMINALE189/1

DE BAKEY PINZA VASCOLARE493, 494, 495, 496, 497,
498, 499, 500, 505, 507, 508, 514, 515, 516, 517,
 DE BAKEY PORT'AGHI210
 DE BAKEY, PINZA ATRAUMATICA BULLDOG100
 DE BAKEY, PINZE ATRAUMATICHE98
 DE BOER DIVARICATORE COSTALE486
 DE LEE FORCIPE602
 DE MARTEL STRUMENTO CONDUTTRICE330
 DE MARTEL STRUMENTO CONDUTTRICE330
 DE MARTEL-WOLFSON PINZA PER ANASTOMOSI546
 DEAN COLTELLO PER IRIDE372
 DEAN FORBICI PER TONSILLE59
 DEAEVER DIVARICATORE145
 DEAEVER FORBICI PER DISSEZIONE52
 DEAEVER-GRIP DIVARICATORE146
 DEBAKEY FORBICI VASCOLARI61
 DEBAKEY FORBICI VASCOLARI TC60
 DEBAKEY PINZA PER ANASTOMOSI505
 DEBAKEY-BAHNSON PINZA ANEURISMA506
 DEBAKEY-DIETHRICH MINI PINZA BULLDOG101
 DEBAKEY-MOSQUITO PINZA EMOSTATICA509
 DEBAKEY-PEAN PINZA EMOSTATICA513
 DEBAKEY-RANKIN PINZA EMOSTATICA512
 DEBAKEY-SATINSKY PINZA PER OCCLUSIONE
 TANGENZIALE502
 DEJERINE MARTELLO DA PERCUSSIONE24
 DELEE DIVARICATORE574
 DEMEL AGO PASSAFILI315
 DEMEL STRUMENTO TENDIFILI315
 DENHART APRIBOCCA454
 DENIS-BROWNE DIVARICATORE ADDOMINALE185
 DEPRESSORE PER EPIGLOTTIDE, REICHERT471
 DEPRESSORE UTERINO, BRAUN586
 DEPRESSORE UTERINO, SIMS586
 DERF PORT'AGHI208
 DERMATOMO, HUMBY50
 DERMATOMO, SILVER50
 DERMATOMOO, SCHINK49
 DERRA PINZA CARDIOVASCOLARE ATRAUMATICA515
 D'ERRICO UNCINO PER NERVI329/2
 DESCHAMPS AGO PER LEGATURE218
 DESJARDINS CUCCHIAIO PER CALCOLI BILIARI534
 DESJARDINS PINZA EMOSTATICA121
 DESJARDINS PINZA PER CALCOLI BILIARI531
 DESJARDINS SONDA PER CALCOLI BILIARI532
 DESMARRS DIVARICATORE151
 DESMARRS PINZA PER CALAZIO393
 DEUTSCHMANN COLTELLO PER CATARATTA371
 DEVILBISS PINZA PER CRANIOTOMIA332
 DEVILBISS PINZA PER CRANIOTOMIA332
 DIAPASON404
 DIAPASON, HARTMANN403
 DIAPASON, LUCAE404
 DIAPASON, REDA403
 DIAPASONN, RYDEL-SEIFFERT404
 DIEFFENBACH PINZA VASCOLARE104
 DIETER MIKRO-PINZA AURICOLARE414
 DIETRICH PINZA MINI BULLDOG101
 DIETRICH FORBICI VASCOLARI60
 DIETRICH PINZA AORTA510
 DILATATOR TRACHEALE LABORDE476
 DILATATORE COOLEY528
 DILATATORE PER CANALE LACRIMALE, WILDER381
 DILATATORE PER CANALE LACRIMALE, ZIEGLER381
 DILATATORE PER CANALE LACRIMALE, CASTROVIEJO381
 DILATATORE PER CONDOTTI BILIARE, BAKES532
 DILATATORE PER SENO FRONTALE RITTER-HALLE433
 DILATATORE TRACHEALE, TROUSSEAU-BABY476
 DILATATORE TRACHEALE, TROUSSEAU476
 DILATATORE TUBBS528
 DILATATORE UTERINO GOODELL581
 DILATATORE UTERINO HANK580
 DILATATORE UTERINO HEGAR578, 579

DILATATORE UTERINO PRATT580
 DILATATORE UTERINO SIMS581
 DILATATORE UTERINO WYLIE581
 DILATATORE VASCOLARE DEBAKEY529
 DINAMOMETRO, COLLIN25
 DINGMAN ELEVATORE463/3
 DINGMANN ABBASSALINGUA456
 DINGMANN APRIBOCCA456
 DINGMANN DIVARICATORE463
 DINGMANN PERIOTOSTOMO463
 DINGMANN TENAGLIA PER OSSA246
 DIPLOMAT SFIGMOMANOMETRO5
 DISSETTORE CORNEALE, PATON373
 DISSETTORE CORNEALE, ELSCHNIG373
 DISSETTORE CORNEALE, GILL373
 DISSETTORE CORNEALE, GREEN374
 DISSETTORE CORNEALE, SATO373
 DISSETTORE CORNEALE, TOOK373
 DISSETTORE GORNEY277
 DISSETTORE PER SACCO LACRIMALE, LANG378
 DISSETTORE PER TONSILLE, HURD465
 DISSETTORE PER TONSILLE, LOPEZ-REINKE465
 DISSETTORE PER TONSILLE, YANKAUER465
 DISSETTORE, FISCH420
 DISSETTORE, PENFIELD333
 DISTRIBUTORE PER PERFORATORI FILIFORME310
 DISTRIBUTORE PER SPAZZOLINI611
 DITTEL CANDELETTA DILATATRICE554
 DIVARICATORE463/3
 DIVARICATORE ADDOMINALE BABY GOSSET181
 DIVARICATORE ADDOMINALE BALFOUR182
 DIVARICATORE ADDOMINALE BALFOUR183
 DIVARICATORE ADDOMINALE BALFOUR BABY182
 DIVARICATORE ADDOMINALE BALFOUR-US184
 DIVARICATORE ADDOMINALE CHARNELLY289
 DIVARICATORE ADDOMINALE COLLIN190
 DIVARICATORE ADDOMINALE COLLIN-LOKTTITE191
 DIVARICATORE ADDOMINALE COMPLETO KIRSCHNER
187/1
 DIVARICATORE ADDOMINALE DENIS-BROWNE185
 DIVARICATORE ADDOMINALE FRAZIER181
 DIVARICATORE ADDOMINALE GELPI189/2
 DIVARICATORE ADDOMINALE GOSSET181
 DIVARICATORE ADDOMINALE HORGAN183
 DIVARICATORE ADDOMINALE JACKSON BURROWS 189/2
 DIVARICATORE ADDOMINALE KIRSCHNER185
 DIVARICATORE ADDOMINALE RICARD191
 DIVARICATORE ADDOMINALE RIGBY189/2
 DIVARICATORE ADDOMINALE ROCHARD186
 DIVARICATORE ADDOMINALE, DE BAKEY189/1
 DIVARICATORE ADDOMINALE, DOYEN189/1
 DIVARICATORE ADDOMINALE, GELPI189/1
 DIVARICATORE ADDOMINALE, SET COMPLETO,
 CON MORSETTI E VALVE193
 DIVARICATORE ADDOMINALE, SET COMPLETO,
 CON SISTEMA DI MONTAGGIO192
 DIVARICATORE ADSON172
 DIVARICATORE ADSON174
 DIVARICATORE ANALE, SMITH-BUIE561
 DIVARICATORE AUFRANC-COBRA289
 DIVARICATORE COLLIN139
 DIVARICATORE COSTALE, COOLEY487
 DIVARICATORE COSTALE, COOLEY-NEONATAL485
 DIVARICATORE COSTALE, DE BOER486
 DIVARICATORE COSTALE, FINOCHIETTO-BURFORD483
 DIVARICATORE COSTALE, HAIGHT487
 DIVARICATORE COSTALE, MORSE484
 DIVARICATORE COSTALE, MORSE-FAVALORO484
 DIVARICATORE COSTALE, RIENHOFF-FINOCHIETTO486
 DIVARICATORE COSTALE, TUFFIER487
 DIVARICATORE CUSHING152
 DIVARICATORE CUSHING153
 DIVARICATORE DELEE574

DIVARICATORE FINSEN	168	DIVARICATORE, COOLEY.....	148	DOYEN PINZA INTESTINALE	540
DIVARICATORE HARRINGTON-PEMBERTON	147	DIVARICATORE, CORYLLOS	166	DOYEN PINZA PER POLIPI UTERINI	585
DIVARICATORE KIRSCHNER.....	187	DIVARICATORE, CRILE	140	DOYEN SPECILLO SCANALATO	199
DIVARICATORE KOCHER	155	DIVARICATORE, CUSHING	151	DOYEN SPECOLO VAGINALE	574
DIVARICATORE KOCHER	159	DIVARICATORE, DARLING.....	178	DOYEN TIRAMIOMI.....	594
DIVARICATORE KOCHER	160	DIVARICATORE, DAVIDSON (SCAPULA).....	166	DOYEN-BABY PINZA INTESTINALE	540
DIVARICATORE KOCHER	163	DIVARICATORE, DEAYER.....	145	DOYEN-JANSEN(MOLT) APRIBOCCA.....	454
DIVARICATORE KÖNIG	153	DIVARICATORE, DEAYER GRIP	146	DOYEN-JANSEN(MOLT) APRIBOCCA.....	454
DIVARICATORE LANGENBECK	158	DIVARICATORE, DESMARRÉS	151	DOYEN-STILLE	167
DIVARICATORE LANGENBECK	159	DIVARICATORE, DINGMANN.....	463	DUBOIS FORBICI GINECOLOGICHE.....	63
DIVARICATORE MARTIN.....	175/1	DIVARICATORE, DOYEN.....	163	DUPLAY PINZA PER ABBASSARE IL COLLO	
DIVARICATORE MAYO-ADAMS	171	DIVARICATORE, DOYEN-STILLE	167	DELL'UTERO	582
DIVARICATORE MEYERDING	157	DIVARICATORE, FARABEUF	139	DUPLAY PINZA PER MEDICATURA	134
DIVARICATORE MEYERDING	177	DIVARICATORE, FRITSCH	163	DUPLEX STETOSCOPIO.....	23
DIVARICATORE MURPHY	156	DIVARICATORE, GIL-VERNET	152	DUPUY-WEISS AGO PER TONSILLE	466
DIVARICATORE NORFOLK-NORDWICH	172	DIVARICATORE, GOELET	141	DURA DISSETTORE.....	332
DIVARICATORE OBWEGESER.....	460, 461	DIVARICATORE, GREEN.....	160	DURA DISSETTORE, DAVIS.....	332
DIVARICATORE PELVICO, ST.MARKS.....	165	DIVARICATORE, HARRINGTON.....	147	DURA DISSETTORE, FRAZIER	333
DIVARICATORE PER CHIRURGIA PLASTICA BREAST	198	DIVARICATORE, HEANEY.....	164	DURA DISSETTORE, HOEN.....	333
DIVARICATORE PER CHIRURGIA PLASTICA CORONAL		DIVARICATORE, HENLEY	170	DURA DISSETTORE, HORSLEY	333
BLOW	198	DIVARICATORE, HIBBS	164	DURA DISSETTORE, MILLIGAN	332
DIVARICATORE PER CHIRURGIA PLASTICA FERRIERA	197	DIVARICATORE, HOESEL	167	DURA DISSETTORE, OLIVECRONA	332
DIVARICATORE PER CHIRURGIA PLASTICA FREEMAN	198	DIVARICATORE, HOFER	465	DURA DISSETTORE, SACHS	332
DIVARICATORE PER CHIRURGIA PLASTICA TEBBETS	197	DIVARICATORE, HOLZHEIMER.....	168	DURA DISSETTORE, TOENNIS	332
DIVARICATORE PER CHIRURGIA PLASTICA		DIVARICATORE, ISRAEL	162	DURA DISSETTORE, WOODSON	333
YANCOSKIE	198	DIVARICATORE, JANSEN	168	DURANTE PINZA DA PRESA.....	88
DIVARICATORE PER CORPI VERTREBRALI, CLOWARD	339	DIVARICATORE, KELLY	164	DUVAL PINZA DA PRESA	85
DIVARICATORE PER CORPI VERTREBRALI, INGE	339	DIVARICATORE, KELLY GRIP	142	DUVAL PINZA PER AFFERRARE INTESTINI	539
DIVARICATORE PER GESSI REDA.....	232	DIVARICATORE, KOCHER-LANGENBECK	159		
DIVARICATORE PER GESSI, BEESON	232	DIVARICATORE, KOERTE	162		
DIVARICATORE PER GESSI, HAGLUND-STILLE	232	DIVARICATORE, LAHEY	157		
DIVARICATORE PER GESSI, HENNIG.....	232	DIVARICATORE, LITTLE	157		
DIVARICATORE PER GUANCE, STERNBERG	453	DIVARICATORE, LOVE	465		
DIVARICATORE PER LA PROSTATA, YOUNG	550	DIVARICATORE, MATHIEU.....	141		
DIVARICATORE PER LABBRA	453	DIVARICATORE, MEYERDING	180		
DIVARICATORE PER LAMINECTOMIA SCOVILLE	196	DIVARICATORE, MIDDELDORFF	160		
DIVARICATORE PER LAMINECTOMIA		DIVARICATORE, MIKULICZ	163		
SCOVILLE-HAVERFIELD	196	DIVARICATORE, MOLLISON	171		
DIVARICATORE PER LAMINECTOMIA, CHERRY	488	DIVARICATORE, MORRIS	164		
DIVARICATORE PER SPINA CERVICALE CASPAR	179	DIVARICATORE, NAGER	465		
DIVARICATORE PER SPINA CERVICALE CASPAR	180	DIVARICATORE, OLLIER	162		
DIVARICATORE PER TIROIDE, SCHOENBORN	479	DIVARICATORE, PARKER	139		
DIVARICATORE PER TORACE, MERCEDES	489	DIVARICATORE, PLESTER	171		
DIVARICATORE PERKINS	168	DIVARICATORE, RAGNELL	140		
DIVARICATORE ROSE	140	DIVARICATORE, RAMUS	461		
DIVARICATORE SAUERBRUCH.....	164	DIVARICATORE, RICHARDSON.....	142		
DIVARICATORE SAUERBRUCH.....	166	DIVARICATORE, RICHARDSON GRIP	142		
DIVARICATORE SCALP-CONTOUR	169	DIVARICATORE, RICHARDSON-EASTMAN	142		
DIVARICATORE SPINALE, TAYLOR	291	DIVARICATORE, ROUX	139		
DIVARICATORE STRANDELL-STILLE	157	DIVARICATORE, ROUX-BABY	140		
DIVARICATORE TESSIER	463/3	DIVARICATORE, ROUX-MINI	140		
DIVARICATORE TRACHEALE	476	DIVARICATORE, SENN-GREEN	153		
DIVARICATORE TRACHEALE, ITERSON	477	DIVARICATORE, SENN-MILLER	143		
DIVARICATORE TRACHEALE, JACKSON.....	476	DIVARICATORE, SIMON	164		
DIVARICATORE TRACHEALE, NEWS	477	DIVARICATORE, SPINA-NASALIS	461		
DIVARICATORE TRAVERS	172	DIVARICATORE, VOLKMANN	153		
DIVARICATORE TUFFIER	147	DIVARICATORE, VOLKMANN	154		
DIVARICATORE VESCICALE, LEGUE	553	DIVARICATORE, WEITLANER	169		
DIVARICATORE VESCICALE, MILLIN	552	DIVARICATORE, WEITLANER-WULLSTEIN.....	169		
DIVARICATORE VESCICALE, MILLIN	553	DIVARICATORE, ZENKER	161		
DIVARICATORE VESCICALE, THOMSON-WALKER.....	552	DIVARICATORE, US-ARMY PARKER-LANG.....	141		
DIVARICATORE VESCICALE, JUDD-MASSON	552	DIVISORE PER CRANIO	267		
DIVARICATORE VOLKMANN	156	DIX SGORBIA PER CORPI ESTRANEI	374		
DIVARICATORE WULLSTEIN	171	DIX STRUMENTI PER CORPI ESTRANEI	380		
DIVARICATORE, ADSON.....	173	DOUGHTY ABBASSALINGUA	458		
DIVARICATORE, ALM	168	DOUGLAS COLTELLO PER TONSILLE	466		
DIVARICATORE, ANDERSON-ADSON.....	172	DOUGLAS PINZA DEPILATORIA	395		
DIVARICATORE, BECKMANN	176	DOYEN DIVARICATORE	163		
DIVARICATORE, BECKMANN-ADSON	175	DOYEN DIVARICATORE ADDOMINALE	189/1		
DIVARICATORE, BECKMANN-EATON	176	DOYEN FORBICI GINECOLOGICHE	63		
DIVARICATORE, BRUNNER	167	DOYEN PERIOTOTOMO	278		
DIVARICATORE, CLOWARD	178	DOYEN PERIOTOTOMO	278		
DIVARICATORE, COLLIN HARTMANN	141	DOYEN PINZA FISSATELI.....	133		

ELEVATORE QUERVAIN.....	275	FISCH UNCINO.....	335	FORBICI PER DISSEZIONE, LEXER.....	53
ELEVATORE SEBILEAU.....	275	FISCH DISSETTORE.....	420	FORBICI PER DISSEZIONE, LEXER-BABY.....	53
ELEVATORE, ALDERDYCE.....	282	FISCHER PINZA PER IRIDE.....	384	FORBICI PER DISSEZIONE, LEXER-BABY TC.....	53
ELEVATORE, BOIES.....	277	FISH SPECILLO.....	199	FORBICI PER DISSEZIONE, MAYO-NOBLE.....	52
ELEVATORE, CREGO.....	282	FISHER COLTELLO PER TONSILLE.....	466	FORBICI PER DISSEZIONE, METZENBAUM.....	53/1
ELEVATORE, FREER.....	434	FOERSTER PINZA PER IRIDE.....	383	FORBICI PER DISSEZIONE, METZENBAUM FINO.....	53/1
ELEVATORE, KEY.....	282	FOERSTER PINZA PER MEDICATURA.....	136	FORBICI PER DISSEZIONE, METZENBAUM TC.....	53/1
ELEVATORE, LEMPERT.....	420	FOMON FORBICI NASALI.....	58	FORBICI PER DISSEZIONE, TOENNIS-ADSON.....	65
ELEVATORE, MCDONALD, 19CM.....	283	FOMON FORBICI PER RINOPLASTICA.....	65/1	FORBICI PER DISSEZIONE, WELLER.....	53/2
ELEVATORE, MURPHY-LANE.....	283	FOMON PERIOSTOTOMO.....	277	FORBICI PER DISSEZIONE, METZENBAUM FINO TC.....	53/1
ELEVATORE, SAYRE.....	281	FOMON RASPA NASALE.....	444	FORBICI PER DURAMADRE, SCHMIEDEN-TAYLOR.....	65/1
ELEVATORE, WATSON-CHEYNE.....	283	FOMON SCALPELLO PER SETTO.....	441	FORBICI PER ENTEROTOMIA.....	66
ELLIOT FORCIPE.....	602	FOMON TC RASPA NASALE.....	445	FORBICI PER EPISIOTOMIA, BRAUN-STADLER.....	64
ELLIS SGORBIA PER CORPI ESTRANEI.....	374	FOMON UNCINO PER LA PELLE.....	447/1	FORBICI PER EPISIOTOMIA, WALDMANN.....	64
ELSCHING DISSETTORE CORNEALE.....	373	FORBICE PER IL SETTO NASALE, KILLIAN.....	471	FORBICI PER FILO DI METALLO E LAMIERA, UNIVERSAL.....	67
ELSCHING SPATOLA PER CICLODIALISI.....	379	FORBICE PER LE UNGHIE.....	609	FORBICI PER INCISIONE.....	52
ELSCHNIG PINZA CAPSULARE.....	391	FORBICE PER PELLE.....	610	FORBICI PER ISTERECTOMIA, WERTHEIM.....	63
ELSCHNIG PINZA FISSATRICE.....	389	FORBICI BULLDOG COTTLE.....	56	FORBICI PER LEGATURE, HEATH.....	66
EMMETT UNCINO PER FISTOLE.....	594	FORBICI CORNEALI, CASTROVIEJO.....	79	FORBICI PER LEGATURE, LITTAUER.....	66
ENDOSPECOLO KOGAN.....	577	FORBICI GINECOLOGICHE, DOYEN.....	63	FORBICI PER LEGATURE, NORTHBENT.....	66
ENGL SEGA PER GESSI.....	229	FORBICI GINECOLOGICHE, DUBOIS.....	63	FORBICI PER LEGATURE, SPENCER.....	66
ENUCLATORE PER TENDINI, BRAND.....	294	FORBICI GINECOLOGICHE, SIEBOLD.....	62	FORBICI PER NEUROCHIRURGIA.....	65
ENUCLATORE PER TENDINI, BUNELL.....	292	FORBICI GINECOLOGICHE, SIMS.....	62	FORBICI PER NEUROCHIRURGIA, STRULLY.....	65
EPPER OSTEOTOMI.....	464/2	FORBICI GINGIVALI, GOLDMAN-FOX.....	67	FORBICI PER OFTALMOLOGIA.....	57
EPPENDORFER PINZA PER BIOPSIA.....	590	FORBICI GINGIVALI, LA GRANGE.....	69	FORBICI PER OFTALMOLOGIA GRADLE.....	57
ERRICO PERFORATORE.....	299	FORBICI GINGIVALI, LOCKKLIN.....	69	FORBICI PER OFTALMOLOGIA, AEBLI.....	58
ESMARCH BENDA PER COMPRESSIONE.....	297	FORBICI GINGIVALI, QUINBY.....	67	FORBICI PER OFTALMOLOGIA, STEVENS.....	58
ESMARCH COLTELLO PER GESSI.....	233	FORBICI GRAEFE.....	56	FORBICI PER PARAMETRIO.....	63
ESMARCH FORBICI PER BENDAGGI.....	69/2	FORBICI NASALI.....	429	FORBICI PER RINOPLASTICA FOMON.....	65/1
ESTENSIONE DELL'ARTICOLAZIONE.....	188	FORBICI NASALI, COTTLE.....	59	FORBICI PER STERNO SCHUMACHER.....	481
ESTRATTATORE, KUENTSCHER.....	322	FORBICI NASALI, FOMON.....	58	FORBICI PER STRABISMO.....	58
ETHICON PINZA APPLICATORE CLIPS.....	524, 525	FORBICI NASALI, HEYMAN.....	58	FORBICI PER STRABISMO.....	58
EVES SERRANODI PER TONSILLE.....	468	FORBICI OCULISTICHE WESTCOTT.....	75	FORBICI PER TONSILLE.....	59
EXACTA SFIGMOMANOMETRO.....	8	FORBICI OCULISTICHE, BARRAQUER.....	75	FORBICI PER TONSILLE, BOETTCHER.....	59
		FORBICI OCULISTICHE, NOYES.....	75	FORBICI PER TONSILLE, DEAN.....	59
		FORBICI OCULISTICHE, VANNAS.....	79	FORBICI PER TONSILLE, GOOD.....	59
F		FORBICI OCULISTICHE, WECKER.....	75	FORBICI PER TONSILLE, PRINCE.....	59
FACE LIFT FORBICI FREEMAN.....	74	FORBICI PER BENDAGGI.....	70	FORBICI POLMONARE, CRAFTOORD.....	65/2
FACE LIFT FORBICI GORNEY.....	73	FORBICI PER BENDAGGI, BERGMANN.....	69/1	FORBICI TORACALI, THOREK.....	65/2
FACE LIFT FORBICI KAYE.....	73	FORBICI PER BENDAGGI, BRUNS.....	70	FORBICI VASCOLARI DEBAKEY TC.....	60
FACE LIFT FORBICI REES.....	73	FORBICI PER BENDAGGI, ESMARCH.....	69/2	FORBICI VASCOLARI, DE BAKEY.....	61
FANSLER PROCTOSCOPO.....	565	FORBICI PER BENDAGGI, KNOWLES.....	70	FORBICI VASCOLARI, DIETRICH.....	60
FARABEUF DIVARICATORE.....	139	FORBICI PER BENDAGGI, LISTER.....	69/1	FORBICI VASCOLARI, FAVALORO.....	61
FARABEUF PERIOSTOTOMO.....	274	FORBICI PER BENDAGGI, LORENZ.....	70	FORBICI VASCOLARI, KELLY.....	61
FARABEUF TENAGLIA PER OSSA.....	243	FORBICI PER BENDAGGI, REDA EXCENTER.....	69/2	FORBICI VASCOLARI, KLINCKENBERG-LOTH.....	65/2
FARABEUF-COLLIN PERIOSTOTOMO.....	274	FORBICI PER BENDAGGI, SEUTIN.....	69/2	FORBICI VASCOLARI, POTTS-DE MARTEL.....	59
FARABEUF-LAMBOTTE TENAGLIA PER OSSA.....	243	FORBICI PER BENDAGGI, SMITH US ARMY.....	69/1	FORBICI VASCOLARI, POTTS-SMITH.....	61
FARRELL PORTACOTONE.....	203	FORBICI PER BENDAGGI, UNIVERSAL.....	70	FORBICI VASCOLARI, SATINSKY.....	65/2
FAULKNER CURETTA.....	449	FORBICI PER BENDAGGI, UNIVERSAL.....	70	FORBICI WAGNER.....	67
FAURE PINZA PER BIOPSIA.....	588	FORBICI PER BENDAGGI, IRIS.....	54	FORCIPE, BARTON.....	603
FAURE PINZA PERITONEALE.....	123	FORBICI PER BENDAGGI, JOSEPH.....	54	FORCIPE, BOERMA.....	604
FAVALORO FORBICI VASCOLARI.....	61	FORBICI PER BENDAGGI, KILNER.....	54	FORCIPE, DE LEE.....	602
FEHLAND PINZA INTESTINALE.....	542	FORBICI PER BENDAGGI, REYNOLDS.....	54	FORCIPE, ELLIOT.....	602
FEILCHENFELD PINZA PER SCHEGGE.....	91	FORBICI PER BENDAGGI, SANVENERO.....	54	FORCIPE, KIELLAND.....	602
FELDHEIM PINZA PER OSSA.....	249	FORBICI PER BENDAGGI, STANDARD.....	51	FORCIPE, KIELLAND-LUIKART.....	603
FERGUSSON CUCCHIAIO PER CALCOLI BILIARI.....	533	FORBICI PER BENDAGGI, SYSTRUNK.....	66	FORCIPE, LUIKART.....	603
FERGUSSON FORBICI PER CHIRURGIA.....	66	FORBICI PER BENDAGGI, TUCKER.....	66	FORCIPE, MCLEAN.....	603
FERGUSSON FRAZIER CANNULA D'ASPIRAZIONE.....	337	FORBICI PER BENDAGGI, METZENBAUM.....	54	FORCIPE, MCLEAN-LUIKART.....	603
FERGUSSON PINZA EMORROIDALE.....	109	FORBICI PER BENDAGGI, SYSTRUNK.....	66	FORCIPE, MCLEAN-TUCKER.....	603
FERGUSSON TENAGLIA PER OSSA.....	243	FORBICI PER BENDAGGI, BUSCH.....	64	FORCIPE, MCLEAN-TUCKER-LUIKART.....	603
FERRIERA DIVARICATORE PER CHIRURGIA PLASTICA.....	197	FORBICI PER BENDAGGI, MOD.USA.....	64	FORCIPE, NAEGELE.....	602
FERRIS-SMITH PINZA CHIRURGICA.....	84	FORBICI PER BENDAGGI, SCHUMACHER.....	64	FORCIPE, PIPER.....	604
FERRIS-SMITH PINZA TAGLIANTE PER LAMINECTOMIA.....	343	FORBICI PER BENDAGGI, SCHUMACHER.....	64	FORCIPE, SIMPSON.....	602
FERRIS-SMITH-KERRISON PINZA TAGLIANTE PER DISCHI INTERVERTEBRALI.....	344, 344/2	FORBICI PER BENDAGGI, BEEBEE.....	68	FORCIPE, SIMPSON-BRAUN.....	602
FICHOCHIETTO-BABY DIVARICATORE COSTALE.....	482	FORBICI PER DISSEZIONE.....	52	FORCIPE, SIMPSON-LUIKART.....	603
FILO PER OSSA.....	314	FORBICI PER DISSEZIONE DEAYER.....	52	FORCIPE, WRIGLEY.....	602
FINOCCHIETTO DIVARICATORE COSTALE.....	482, 484	FORBICI PER DISSEZIONE MAYO.....	52	FOREGGER LARINGSOCOPIO.....	29
FINOCCHIETTO PINZA PER BRONCHI.....	490	FORBICI PER DISSEZIONE MAYO, TC.....	52	FOREGGER LARINGSOCOPIO SET.....	31
FINOCCHIETTO DIVARICATORE COSTALE.....	484	FORBICI PER DISSEZIONE MAYO-STILLE.....	52	FOX CURETTA PER LUPUS.....	608
FINOCCHIETTO PORT'AGHI.....	211	FORBICI PER DISSEZIONE MAYO-STILLE, TC.....	52	FRAENKEL INSERTO.....	472
FINOCCHIETTO-BURFORD DIVARICATORE COSTALE.....	483	FORBICI PER DISSEZIONE METZENBAUM.....	53/1	FRAENKEL PINZA PER POLIPI LARINGEI.....	471
FINSEN DIVARICATORE.....	168	FORBICI PER DISSEZIONE, JORGENSEN.....	53	FRANCIS AGO PER CORPI ESTRANEI.....	374

FRANKLIN-SILVERMANN AGO PER BIOPSIA	206	GRAFFA PER IL CUIOIO CAPELLUTO, RANEY	327	HEIFETZ SPATOLA CEREBRALE	369
FRAZIER DIVARICATORE ADDOMINALE	181	GRAHAM UNCINO PER NERVI	329	HEIMING PINZA PER CALCOLI RENALI	536
FRAZIER DURA DISSETTORE	333	GRAIG PINZA NASALE	426	HEISS PINZA EMOSTATICA	112
FRAZIER UNCINO PER LA PELLE	149	GRAVE SPECOLO VAGINALE	570	HEISTER APRIBOCCA	454
FREEMAN DIVARICATORE PER CHIRURGIA PLASTICA	198	GRAY PINZA EMOSTATICA	121	HENKE ELEVATORE PER TONSILLE	465
FREEMAN FACE LIFT FORBICI	74	GREEN DISSETTORE CORNEALE	374	HENLEY DIVARICATORE	170
FREER COLTELLO PER SETTO NASALE	434	GREEN DIVARICATORE	160	HENNIG DIVARICATORE PER GESSI	232
FREER ELEVATORE	434	GREEN PINZA FISSATRICE	390	HEPP-SCHEIDEL MICRO FORBICI	78
FREER ELEVATORE PER SETTO	437	GREEN UNCINO PER IL STRABISMO	375	HERRICK PINZA PER PEDUNCOLO RENALE	123
FREER SCALPELLO PER SETTO	GREEN-ARMYTAGE PINZA UTERINA PER EMOSTASI	605	HESS PINZA CAPSULARE	391
FREER UNCINO PER LA PELLE	448	GREGORY PINZA CARDIOVASCOLARE ATRAUMATICA	517	HESS PINZA PER IRIDE	384
FRENZEL ABBASSALINGUA	451	GREVEN MIKRO-PINZA AURICOLARE	414	HESS UNCIÓN PER NERVI	329/1
FRENZEL OCCHIALI NISTAGMO	20	GROSS CUCCHIAIO AURICOLARE	409	HEYMANN PINZA PER SETTO NASALE	425
FRIEDMANN MINI PINZA SGORBJA	234	GROSS-MAIER PINZA PER MEDICATURA	134	HEYMANN FORBICI NASALI	58
FRIEDMANN SPECOLO VAGINALE	577	GRUBER SPECOLO AURICOLARE	399	HEYMANN-KNIGHT PINZA AURICOLARE	425
FRITSCH DIVARICATORE	163	GUAINA PER VITI	325	HEYWOOD-SMITH PINZA PER EMORROIDI	567
FRYKHOLM PINZA SGORBJA	240	GUIDA CONDUTTRICE	321	HIBBS OSTEOTOMO	265
FUCHS PINZA CAPSULARE	391	GUIDA TENDINI, BUNELL	294	HIBBS DIVARICATORE	164
FUCHSIG PINZA EMOSTATICA	113	GUILLEN CANNULA PER ASPIRAZIONE	433/1	HIBBS SCALPELLO	265
G		GUTHRIE UNCINO PER LA PELLE	149	HIBBS SGORBJA	265
GALLAHER RASPA NASALE	446	GUYON CANDELETTA DILATRICE	554	HILL-FERGUSON SPECOLO RETTALE	560
GASS UNCINO	376	GUYON INTRODUTTORE PER CATETERI	554	HIRSCHMAN SPATOLA PER CICLODIALISI	379
GAUSS PINZA PER IL CUIOIO CAPELLUTO	605	GUYON PINZA EMOSTATICA	122	HIRSCHMANN ANOSCOPO	562
GELPI DIVARICATORE ADDOMINALE	189/1	GUYON PINZA RENALE	122	HOEN DURA DISSETTORE	333
GELPI DIVARICATORE ADDOMINALE	189/2	GUYTON-LUNDGAARD SCLEROTOMO	373	HOESEL PORT'AGHI	213
GEMINI PINZA EMOSTATICA	115	H		HOESEL PORT'AGHI,	213
GERALD PINZA ANATOMICA	86	HABERER SPATOLA ADDOMINALE E INTESTINALE	143/1	HOFER DIVARICATORE	465
GERALD PINZA CHIRURGICA	87	HAGLUND-STILLE DIVARICATORE PER GESSI	232	HOFFMANN PINZA SERRATUBI	624
GERSTER PINZA PER OSSA	250	HAIGHT DIVARICATORE COSTALE	487	HOHMANN MINI ELEVATORE PER OSSA	286
GERZOG MARTELLO	270	HAIJK MARTELLO	273	HOLINGER LARINGOSCOPIO PER OPERAZIONE	37
GHIGLIOTTINA PER TAGLIARE FILI 32CM	320	HAIJK SCALPELLO PER SETTO	442/1	HOLLINGER PORTATORE DI LUCE	37
GIERTZ-STILLE COSTOTOMO	481	HAIJK-BALLENGER ELEVATORE PER SETTO	439	HOLSHER UNCINO PER RADICI DEI NERVI	329/1
GIGLI SEGA	332	HAIJK-KOFLER PINZA SFENOIDALE	430, 431	HOLTH PINZA TAGLIANTE PER CAPSULA	380
GILL DISSETTORE CORNEALE	373	HALLE CURETTA TAGLIANTE	253	HOLZBACH PINZA PER ISTERECTOMIA	126
GILL PINZA PER IRIDE	384	HALLE ELEVATORE PER SETTO	437	HOLZBACH PINZA PER ISTERECTOMIA	126
GILL-ARRUGA PINZA CAPSULARE	390	HALSEY PORT'AGHI	208	HOLZHEIMER DIVARICATORE	168
GILL-HESS PINZA PER IRIDE	384	HALSTED-MOSQUITO PINZA EMOSTATICA	105	HOPKINS COLTELLO PER GESSI	233
GILLIES PINZA CHIRURGICA	86	HANK DILATATORE UTERINO	580	HORGAN DIVARICATORE ADDOMINALE	183
GILLIES PORT'AGHI	212	HARGIS ELEVATORE PER PERIOSTIO	463/2	HORIZON PINZA APPLICATORE CLIPS	524, 525
GILLIES UNCINO PER LA PELLE	448	HARGIS SEPERATORE PER IL CORPO		HORSLEY DURA DISSETTORE	333
GIL-VERNET DIVARICATORE	152	MANDIBOLARE	463/6	HÖSEL DIVARICATORE	167
GIUNTO DI PROLUNGAMENTO	299	HARKEN PINZA AURICOLA	503	HOUSE CANNULA D'ASPIRAZIONE	337/2
GLOVER BULLDOG PINZA ATRAUMATICA	100	HARMS, SONDA	381	HOUSE CURETTA	420
GLOVER BULLDOG PINZA ATRAUMATICA	103	HARRINGTON DIVARICATORE	147	HOWARTH ELEVATORE PER SETTO	438
GLOVER PINZA VASCOLARE	515	HARRINGTON PINZA PER BRONCHI	490	HUBER MANICO UNIVERSALE	472
GLUCK COSTOTOMO	480	HARRINGTON-PEMBERTON DIVARICATORE	147	HUDSON MANICO A T	300
GOELT DIVARICATORE	141	HARTMANN ABBASSALINGUA	452	HUDSON PERFORATORE A MANO	299
GOLDMANN-FOX FORBICI GINGIVALI	67	HARTMANN CANNULA PER IRRIGAZIONE	433	HULKA PINZA PER ABBASSARE IL COLLO	
GOMEL MICRO FORBICI	80	HARTMANN CANNULA PER IRRIGAZIONE	433	DELL'UTERO	583
GOMEL MICROPINZA CHIRURGICA	96	HARTMANN CATETERE AURICOLARE	408	HUMBY DERMATOMO	50
GONIOMETRO PER LE DITA	25	HARTMANN DIAPASON	403	HUNTER PINZA PER SCHEGGE	91
GONIOMETRO, MOELTGEN	25	HARTMANN PINZA PER CORPI ESTRANEI	412	HURD DISSETTORE PER TONSILLE	465
GOOD FORBICI PER TONSILLE	59	HARTMANN PINZA EMOSTATICA	104	I	
GOODELL DILATATORE UTERINO	581	HARTMANN PINZA PER POLIPI	424	I.U.D. PINZA DA PRESA FLESSIBILE, SERPENTINE	593
GORNEY DISSETTORE	277	HARTMANN SPECOLO AURICOLARE	399	I.U.D. UNCINO ESTRATTORE	593
GORNEY FACE LIFT FORBICI	73	HARTMANN SPECOLO NASALE	422	IMPATTATORE	322
GOSSET DIVARICATORE ADDOMINALE	181	HARTMANN-HALLE SPECOLO NASALE	421	IMPATTATORE / ESTRATTORE	322
GOURDET CUCCHIAIO UTERINO	599	HARTMANN-HOFFMANN PINZA PER CORPI		IMPATTATORE FINALE, KUENTSCHER	321
GRADLE FORBICI PER OFTALMOLOGIA	57	ESTRANEI	412	INGE DIVARICATORE PER CORPI VERTEBRALI	339
GRADLE PINZA DEPIPARATORIA	395	HARTMANN-WULLSTEIN PINZA PER CORPI		INSERTO, BARACANI	472
GRAEFLE BLEFAROSTATO	370	ESTRANEI	412	INSERTO, BRUENINGS	472
GRAEFLE CISTOTOMO	375	HAUGH MIKRO-PINZA AURICOLARE	414	INSERTO, CORDES	472
GRAEFLE COLTELLO LANCEOLARE	372	HAYES PINZA PER ANASTOMOSI DEL RETTO	545	INSERTO, FRAENKEL	472
GRAEFLE COLTELLO LANCEOLARE	372	HEANEY PINZA PER ISTERECTOMIA	126	INSERTO, FRAENKEL	472
GRAEFLE COLTELLO PER CATARATTA	371	HEANEY PORT'AGHI	210	INSERTO, KRAUSE	472
GRAEFLE CUCCHIAIO PER CATARATTA	377	HEANY CURETTA PER BIOPSIA	587	INSERTO, LANGE	472
GRAEFLE FORBICI	56	HEANY DIVARICATORE	164	INSERTO, SCHEINMANN	472
GRAEFLE PINZA DA PRESA	83	HEANY-BALLENTE PINZA PER ISTERECTOMIA	127	INSERTO, SCHUMACHER	472
GRAEFLE PINZA FISSATRICE	389	HEATH FORBICI PER LEGATURE	66	INSERTO, SEIFERT	472
GRAEFLE PINZA PER IRIDE	382	HEATH MARTELLO	273	INSOFFIATORE D'ARIA, POLITZER	406
GRAEFLE UNCINO	149	HEBRA CURETTA DA CALAZIO	377	INSOFFIATORE PER POLVERE, KABIERSKE	405
GRAEFLE UNCINO PER IL STRABISMO	375	HEGAR DILATATORE UTERINO	578, 579	INSTRU-CARE OLIO PER STRUMENTI	634
		HEGENBARTH PINZA PER AGRAFES	224		

INTRODUTTORE PER CATETERI GUYON	554	KEINSASSER LARINGOSCOPIO PER OPERAZIONE	35	KOGAN ENDOSPECOLO	577
IOWA AGO DI GUIDA	206	KEITH AGO	223	KÖNIG DIVARICATORE	153
IOWA PINZA PER ABBASSARE IL COLLO DELL'UTERO	584	KELLY DIVARICATORE	164	KÖNIG ELEVATORE PER OSSA	284
IRIS FORBICI	54	KELLY FORBICI VASCOLARI	61	KÖNIG PERIOTOTOMO	276
IRIS FORBICI, KNAPP	55	KELLY GRIP DIVARICATORE	142	KÖNIG SPECILLO DI GUIDA SCANALATO	221
IRIS FORBICI, LITTLER	55	KELLY PINZA EMOSTATICA	106	KOOS COLTELLO PER DURA MADRE	335
IRIS SUPERCUT FORBICI	72	KELLY PINZA PER POLIPI UTERINI	585	KÖRTE SPATOLA ADDOMINALE ED INTESTINALE	143/1
ISRAEL DIVARICATORE	162	KELLY PROCTOSCOPIO	562, 563	KRAUSE INSERTO	472
ISTEROMETRO VALLEIX	586	KELLY-RANKIN PINZA EMOSTATICA	106	KRAUSE SERRANODI	431/2
ISTEROMETRO, COLLIN	586	KERN TENAGLIA PER OSSA	244	KRAUSE SERRANODI	433/2
ISTEROMETRO, MARTIN	586	KERRISON PINZA TAGLIENTE NASALE	428	KRAUSE-VOSS SERRANODI	433/2
ISTEROMETRO, SIMS	586	KEVORKIAN CURETTA PER BIOPSIA	587	KRAYENBÜHL UNCINO PER NERVI	336
ITERSON DIVARICATORE TRACHEALE	477	KEVORKIAN PINZA PER BIOPSIA	589	KRISTELLER SPECOLO VAGINALE	572
IVES-FANSLER ANOSCOPIO	562, 563	KEVORKIAN-PACIFIC PINZA PER BIOPSIA	592	KROENIG ABBASSALINGUA	451
IWANSON COMPASSO	624	KEY ELEVATORE	282	KRONECKER AGO PER LEGATURE	219
J		KEYES TREFINA CUTANEA	608	KUGLEN UNCINO	376
JACKSON BURROWS DIVARICATORE ADDOMINALE	189/2	KIELLAND FORCIPE	602	KUHNT RASCHIATOIO CORNEALE	373
JACKSON DIVARICATORE TRACHEALE	476	KIELLAND-LUIKART FORCIPE	603	KÜMMEL SPATOLA ADDOMINALE	144
JACKSON LARINGOSCOPIO PER OPERAZIONE	37	KILLIAN PER IRRIGAZIONE	433, 433/1	KÜMMEL SPATOLA ADDOMINALE E INTESTINALE	143/2
JACKSON PINZA PER AFFERRARE TENDINI DA PRESA	292	KILLIAN CANNULA PER IRRIGAZIONE	433, 433/1	KÜNTSCHER ALESATORE PER FEMORE	321
JACKSON PINZA PER POLIPI LARINGEI	471	KILLIAN FORBICE PER IL SETTO NASALE	471	KÜNTSCHER ALESATORE PER L'APERTURA DEL MIDOLLO	321
JACKSON SPECOLO VAGINALE	573	KILLIAN SGORBIA	442/1	KÜNTSCHER ESTRATTATORE	322
JACOBS PINZA PER ABBASSARE IL COLLO DELL'UTERO	583	KILLIAN-CLAUS SGORBIA PER SETTO	442/1	KÜNTSCHER IMPATTATORE FINALE	321
JACOBSON CURETTA TAGLIENTE	257	KILLNER FORBICI PER CHIRURGIA	54	L	
JACOBSON PINZA EMOSTATICA	105	KILNER PORT'AGHI	212	LA FORCE AGO PER CORPI ESTRANEI	374
JACOBSON PORT'AGHI	215	KILNER SUPERCUT FORBICI	72	LA FORCE COLTELLO ADENOIDE	450
JACOBSON Sonda BOTTUNUTA	335	KILNER UNCINO NASALE	447/1	LA GRANGE FORBICI GINGIVALI	69
JACOBSON UNCINO PER DURA MADRE	335	KILNER UNCINO PER LA PELLE	608	LABORDE DILATATORE TRACHEALE	476
JAEGER COLTELLO LANCEOLARE	372	KILNER-DOUGHTY APRIBOCCA	456	LACRIMAL CANNULA OCULISTICA	394
JAEGER PLACCA PER PALPEBRE	371	KIRBY-ARTHUR PINZA PER IRIDE	385	LAHEY DIVARICATORE	157
JAMESON PINZA PER STRABISMO	385	KIRK MARTELLO	270	LAHEY PINZA EMOSTATICA	119/2
JAMESON UNCINO PER IL STRABISMO	375	KIRSCHNER ARCO PER ESTENSIONE	312	LAHEY PINZA PER GOZZO	479
JANSEN CURETTA TAGLIENTE	257	KIRSCHNER DIVARICATORE ADDOMINALE	185	LAHEY UNCINO ACUTO	149
JANSEN DIVARICATORE	168	KIRSCHNER DIVARICATORE ADDOMINALE COMPLETO	187/1	LAMA DI RASOIO	45
JANSEN PINZA AURICOLARE	424	KIRSCHNER PERFORATORE A MANO	299	LAMA DI RICAMBIO	49
JANSEN PINZA SGORBIA	237	KIRSCHNER PERFORATORI FILIFORME	306, 307	LAMA DI RICAMBIO, STERILE	50
JARCHO PINZA PER ABBASSARE IL COLLO DELL'UTERO	583	KIRSCHNER SPECILLO DI GUIDA SCANALATO	221	LAMA PER OSTEOTOMI	266
JAVID PINZA PER CAROTIDE	511	KIRSCHNER US ARCO PER ESTENSIONE	312	LAMA PER SCALPELLI	266
JENNINGS APRIBOCCA	454	KIRSCHNER TELAIO PIEGABILE	187	LAMBERT PINZA PER CALAZIO	393
JENSEN CANNULA OCULISTICA	394	KIT PER AUTOPSIA IN ASTUCCIO DI LEGNO	269	LAMBERT-KAY PINZA PER ANASTOMOSI	505
JOBSON-HORNE PORTACOTONE	203	KLAPP DIVARICATORE	150	LAMBERT-LOWMAN PINZA PER OSSA	249
JOHNS-HOPKINS BULLDOG PINZA	104	KLEINERT-KUTZ PINZA PER AFFERRARE TENDINI	294	LAMBOTTE OSTEOTOMO	261
JOHNS-HOPKINS PINZA APPLICATRICE	104	KLEINERT-KUTZ PINZA SGORBIA	237	LAMBOTTE TENAGLIA PER OSSA	244
JOHNS-HOPKINS PINZA EMOSTATICA	120	KLEINERT-KUTZ UNCINO PER LA PELLE	149	LAME PER BISTURI, STERILI	42
JOHNSON PORT'AGHI	211	KLEINSASSER BRACCIO PORTALARINGOSCOPIO STERNALE	36	LAME PER BISTURI, STERILI	42
JONES PINZA FISSATELI	132	KLEINSASSER CANNULA DA INIEZIONE	36	LAMPADA FRONTALE, CLAR	22
JORGENSEN FORBICI PER DISSEZIONE	53	KLEINSASSER CANNULA D'ASPIRAZIONE	36	LANCASTER BLEFFAROSTATO	371
JOSEPH (LEWIS) RASPA NASALE	443	KLEINSASSER PORTATORE DI LUCE FREDDA A FIBRE DI VETRO	36	LANDAU SPECOLO VAGINALE	577
JOSEPH COLTELLO NASALE	434	KLEINSCHMIDT PINZA PER APPENDICE	544	LANDOLT PINZA DA PRESA PER TUMORI	341
JOSEPH ELEVATORE PER SETTO	437	KLINKENBERGH-LOTH	65/2	LANE CACCIAVITE	323, 324
JOSEPH FORBICI PER CHIRURGIA	54	KNAPP COLTELLO PER IRIDE	372	LANE ELEVATORE PER OSSA	290
JOSEPH PERIOTOTOMO	277	KNAPP CUCCHIAIO PER CATERATTA	378	LANE PIEGAPLACCHE	325
JOSEPH RASPA NASALE	443	KNAPP IRIS FORBICI	55	LANE PINZA CHIRURGICA	84
JOSEPH SEGA NASALE	446	KNAPP UNCINO DIVARICATORE	375	LANE PINZA FISSATELI	133
JOSEPH UNCINO PER LA PELLE	149	KNAPP-LUER PINZA PER TRACOMA	393	LANE PINZA PORTAPLACCHE	325
JUDD-ALLIS PINZA PER AFFERRARE INTESTINI	538	KNIGHT PINZA PER SETTO NASALE	425	LANE PINZA PORTAVITI	325
JUDD-MASSON DIVARICATORE VESCICALE	552	KNOWLES FORBICI PER BENDAGGI	70	LANE PINZA STOMACALE	547
JUERS MIKRO-PINZA AURICOLARE	414	KOCHER DIVARICATORE	155	LANE TENAGLIA PER OSSA	244
JURASZ PINZA PER POLIPI LARINGEI	471	KOCHER DIVARICATORE	159	LANE TRETOWAN ELEVATORE PER OSSA	290
K		KOCHER DIVARICATORE	160	LANG DISSETTORE PER SACCO LACRIMALE	378
KABIERSKE INSOFFIATORE PER POLVERE	405	KOCHER DIVARICATORE	163	LANGE INSERTO	472
KADER SPATOLA ADDOMINALE ED INTESTINALE	143/1	KOCHER DIVARICATORE	108	LANGE UNCINO PER LE PINNE NASALI	448
KALLMORGEN SPECOLO VAGINALE	573	KOCHER PINZA EMOSTATICA	540	LANGE-HOHMANN ELEVATORE PER OSSA	286
KALT PINZA CAPSULARE	391	KOCHER PINZA INTESTINALE	479	LANGE-BECK ANSA AURICOLARE	409
KALT, PORT'AGHI,	214	KOCHER Sonda PER GOZZO	552	LANGENBECK COLTELLO PER AMPUTAZIONE	44
KALT-ARRUGA PORT'AGHI	214	KOCHER SPATOLA VESCICALE	159	LANGENBECK COLTELLO PER CARTILAGINI	47
KANE PINZA OMBELICALE	605	KOENIG AGO	223	LANGENBECK DIVARICATORE	158
KANTROWITZ PINZA EMOSTATICA	119/1	KOERTE DIVARICATORE	162	LANGENBECK DIVARICATORE	159
KAYE FACE LIFT FORBICI	73			LANGENBECK PERIOTOTOMO	275
				LANGENBECK PORT'AGHI	213
				LANGENBECK SEGA PER DITA	296

LANGENBECK TENAGLIA PER OSSA	243	LOWMAN-HOGLUND PINZA PER OSSA	249	MATHIEU PINZA PER CORPI ESTRANEI	553/1
LANGENBECK-GREEN DIVARICATORE	153	LUBET-BARBON PINZA NASALE PER TAMPONI	424	MATHIEU PORT'AGHI	213
LARINGOSCOPIO MC INTOSH	29	LUC PINZA PER SETTO NASALE	426	MATHIEU SPECCHIO RETTALE	560
LARINGOSCOPIO MILLER	30	LUCAE AGO PER PARACENTESI	408	MATHIEU-OLSEN PORT'AGHI	212
LARINGOSCOPIO PER OPERAZIONE KLEINSASSER	35	LUCAE DIAPASON	404	MATSON PERIOSTOTOMO	279
LARINGOSCOPIO FOREGGER	29	LUCAE MARTELLO	271	MATSON-ALEXANDER PERIOSTOTOMO	279
LARSEN PINZA PER AFFERRARE TENDINI	292	LUCAE PINZA AURICOLARE	410	MAUNDER APRIBOCCA DI LEGNO	459
LAWRENCE PINZA EMOSTATICA	119	LUCAE UNCINO	409	MAXI GRASPER PINZA PER BIOPSIA	593
LEBSCHKE SCALPELLO PER STERNO	267	LUER CANNULA TRACHEALE	479	MAYFIELD PINZA SGORBIA	238
LEES PINZA PER BRONCHI	504	LUER DIVARICATORE	140	MAYO ABBASSALINGUA	451
LEGATORE EMORROIDALE, MC GIVNEY	568	LUER PINZA SGORBIA	236	MAYO CUCCHIAIO PER CALCOLI BILIARI	534
LEGATORE EMORROIDALE RUDD	568	LUER-KOERTE CUCCHIAIO PER CALCOLI BILIARI	533	MAYO FORBICI PER DISSEZIONE	52
LEGUE DIVARICATORE VESCICALE	553	LUIKART FORCIPE	603	MAYO PINZA	89
LEGUEU SPATOLA VESCICALE	552	LUIKART-BILL TRATTORE	604	MAYO SONDA PER CALCOLI BILIARI	534
LEKSELL(STILLE) PINZA SGORBIA	240	LUNDSGAARD SCLEROTOMO	373	MAYO SPILLONE PER STERILIZZAZIONE	227
LELAND-JONES PINZA VASCOLARE	494	LUNIATSCHEK TAMPONATORE	465	MAYO SUPERCUT FORBICI	71
LEMPERT CURETTA TAGLIANTE	256			MAYO-ADAMS DIVARICATORE	171
LEMPERT ELEVATORE	420	M		MAYO-BLAKE PINZA PER CALCOLI BILIARI	531
LEMPERT PINZA SGORBIA	237	MAGIL PINZA PER INTRODUZIONE SONDE	28	MAYO-COLLINS DIVARICATORE	141
LERCHE PINZA DA PRESA	83	MAGLIA METALLICA PER ESTENSIONE	311	MAYO-COLLINS DIVARICATORE-SET	141
LERICHE PINZA EMOSTATICA	111	MALTZ (COTTE) RASPA NASALE	444	MAYO-HABERISSER PINZA TORCIFILI	319
LERICHE SPATOLA ADDOMINALE E INTESTINALE	143/2	MALTZ RASPA NASALE	443	MAYO-HEGAR PORT'AGHI	209
LESINA	304	MANICI PER LAMA BISTURI	38	MAYON-GUYON PINZA EMOSTATICA	122
LESINA, PERTHES	304	MANICI PER LAMA BISTURI	39	MAYO-NOBLE FORBICI PER DISSEZIONE	52
LESTER PINZA FISSATRICE	389	MANICI PER LAMA BISTURI	39/1	MAYO-ROBSON PINZA INTESTINALE	541
LEVA PER CORPI ESTRANEI, BUCK	412	MANICI PER LAMA BISTURI	39/2	MAYO-STILLE FORBICI PER DISSEZIONE	52
LEVA PER CORPI ESTRANEI, QUIRE	412	MANICI PER LAMA BISTURI	40	MAYO-STILLE SUPERCUT FORBICI	71
LEVA PIEGAPLACCHE, LANE	325	MANICI PER LAMA BISTURI	41	MC DONALD ELEVATORE	283
LEVINSON AGO PER CORPI ESTRANEI	374	MANICO	266	MC INDOE CESOIA PER OSSA	241
LEWIN TENAGLIA PER OSSA	246	MANICO	266	MC INTOSH LARINGOSCOPIO	29
LEXER BABY FORBICI PER DISSEZIONE	53	MANICO	300	MC INTOSH LARINGOSCOPIO SET	31
LEXER FORBICI PER DISSEZIONE	53	MANICO A BATTERIA PER LUCE CALDA	32	MC KENZIE PERFORATORE	299
LEXER MINI SGORBIA	263	MANICO A BATTERIA PER LUCE CALDA	34	MCCULLOUGH PINZA PER STRABISMO	385
LEXER OSTEOTOMO	263	MANICO A BATTERIA PER LUCE FREDDA	33	MC GEE MIKRO-PINZA AURICOLARE	414
LEYLA SISTEMA DI FISSAGGIO	368, 368/1, 368/2, 368/3, 368/4	MANICO A T, HUDSON	300	MC GEE UNCINO	419
LICHTENBERG PORT'AGHI	213	MANICO CON ATTACCO RAPIDO	301	MCGIVNEY LEGATORE EMORROIDALE	568
LICHTWITZ CANNULA	433	MANICO D'ASPIRAZIONE WULLSTEIN	338	MCGIVNEY PINZA EMORROIDALE	568
LICHTWITZ TREQUARTO PER SENO MASCELLARE	204	MANICO PER STRUMENTI MICROLARINGEI	475	MCINDOE FORBICI PER CARTILAGINE	65/1
LIEBERMANN BLEFAROSTATO	371	MANICO UNIVERSALE, HUBER	472	MCINDOE PINZA CHIRURGICA	85
LIMA PER OSSA	294	MANO DI PIOMBO	250	MCINTYRE CANNULA OCULISTICA	394
LIMA PER OSSA	612/1	MARCATORE, CONNIN-AMSLER	380	MCIVOR APRIBOCCA	457
LIMETTA PER LE UNGHIE	610	MARQUARDT PINZA SGORBIA	239	MCKENY ELEVATORE PER SETTO	437
LISTER FORBICI PER BENDAGGI	69/1	MARSHIK PINZA PER TONSILLE	468	MCKENZIE PINZA POSA CLIPS	326
LISTER SUPERCUT FORBICI	72	MARTEL PINZA DA PRESA	110	MCCLEAN FORCIPE	603
LISTER(SINUS) TUPFERZA	137	MARTELLO DI PERCUSSIONE, BABINSKY	24	MCCLEAN-LUIKART FORCIPE	603
LISTER-BURCH BLEFAROSTATO	370	MARTELLO DI PERCUSSIONE, BERLINER	24	MCCLEAN-TUCKER-LUIKART FORCIPE	603
LISTON CESOIA PER OSSA	241	MARTELLO DI PERCUSSIONE, BUCK	24	MCPHERSON PINZA PER FILO	392
LISTON COLTELLO PER AMPUTAZIONE	44	MARTELLO DI PERCUSSIONE, TAYLOR	24	MEAD MARTELLO	271
LITTAUER FORBICI PER LEGATURE	66	MARTELLO DI PERCUSSIONE, TROEMNER	24	MEAD PINZA SGORBIA	235
LITTAUER PINZA AURICOLARE	411	MARTELLO IN PLASTICA	271	MEEKER PINZA EMOSTATICA	119
LITTAUER PINZA DEPIILATORIA	395	MARTELLO, BERGMANN	272	MEHDORN CLIPS PER VASI	362
LITTAUER PINZA PER POLIPI	425	MARTELLO, COLLIN	270	MEHDORN PINZA POSA CLIPS	362
LITTLE DIVARICATORE	157	MARTELLO, COTTLE	273	MELLINGER BLEFAROSTATO	370
LITTLEL IRIS FORBICI	55	MARTELLO, GERZOG	270	MELLINGER-AXENFELD BLEFAROSTATO	370
LITTLEWOOD PINZA PER AFFERRARE INTESTINI	538	MARTELLO, HAJEK	273	MENGHINI AGO PER BIOPSIA	206
LOCKHART-MUMMERY SPECILLO PER FISTOLE	200	MARTELLO, HEATH	273	MERCEDES DIVARICATORE PER TORACE	489
LOCKLIN FORBICE GINGIVALI	69	MARTELLO, KIRK	270	MERIAM PINZA DENTALE	93
LOCKWOOD-ALLIS PINZA PER AFFERRARE INTESTINI	538	MARTELLO, LUCAE	271	METZENBAUM FINO TC FORBICI PER DISSEZIONE	53/1
LONDON-COLLEGE PINZA DENTALE	93	MARTELLO, MEAD	271	METZENBAUM FORBICI PER CHIRURGIA	54
LOPEZ-REINKE DISSETTORE PER TONSILLE	465	MARTELLO, OMBREDANNE	273	METZENBAUM FORBICI PER DISSEZIONE	53/1
LORENZ FORBICI PER BENDAGGI	70	MARTELLO, PARTSCH	271	METZENBAUM PORT'AGHI	211
LORNA PINZA FISSATELI	133	MARTELLO, QUISLING	271	METZENBAUM SUPERCUT FORBICI	71
LOUTE STRUMENTO TENDIFILI	315	MARTELLO, WILLIGER	271	METZENBAUM TC FORBICI PER DISSEZIONE	53/1
LOVE DIVARICATORE	465	MARTIN DIVARICATORE	175/1	MEYERDING DIVARICATORE	157
LOVE UNCINO PER NERVI	329/2	MARTIN FORBICI PER CARTILAGINE	65/1	MEYERDING DIVARICATORE	177
LOVE UNCINO PER RADICI DEI NERVI	330	MARTIN ISTEROMETRO	586	MEYERDING DIVARICATORE	180
LOVE-GRUENWALD PINZA TAGLIANTE PER LAMINECTOMIA	340	MARTIN PELVIMETRO	605	MEYHOEFER CURETTA DA CALAZIO	377
LOVELACE PINZA EMOSTATICA	109	MARTIN TENAGLIA PER OSSA	246	MICHEL AGRAFES	224
LOVELACE PINZA PER AFFERRARE IL POLMONE	490	MARTINI CURETTA TAGLIANTE	257	MICHEL PINZA PER AGRAFES	224
LOWER PINZA EMOSTATICA	120	MASING-NEIVERT UNCINO NASALE	447/1	MICHEL SPECCHIO LARINGEO	423
LOWMAN PINZA PER OSSA	249	MASSON PORT'AGHI	210	MICRO FORBICI	76
		MASTIN PINZA MUSCOLARE	479	MICRO FORBICI	77
		MATHIEU DIVARICATORE	141	MICRO FORBICI	78

MICRO FORBICI AURICOLARI, BELLUCCI.....	413	MUSEUM PINZA PER ABBASSARE IL COLLO		O'SULLIVAN-O'CONNOR SPECOLO VAGINALE.....	576
MICRO FORBICI AURICOLARI, SHEA.....	413	DELL'UTERO.....	583	OTIS URETROTOMO.....	553
MICRO FORBICI, GOMEL.....	80	MYLES PINZA NASALE.....	427	OVERHOLT PINZA EMOSTATICA.....	114
MICRO FORBICI, HEPP-SCHEIDEL.....	78			OVERHOLT-BABY PINZA EMOSTATICA.....	114
MICRO FORBICINE, BELLUCCI.....	417	N		OVERHOLT-GEISENDOERFER PINZA EMOSTATICA.....	114
MICRO FRIEDMANN PINZA SGORBIA.....	234	NABATOFF SET PER VARICI IN SCATOLA DI METALLO ...	201	OVERHOLT-MIXTER PINZA EMOSTATICA.....	115
MICRO PINZA AURICOLARE.....	415	NAEGELE FORCIPE.....	602		
MICRO PINZA AURICOLARE A CUCCHIAIO		NAGER AGO PER TONSILLE.....	466	P	
WULLSTEIN.....	416	NAGER DIVARICATORE.....	465	PADELLA.....	621
MICRO-HARTMANN PINZA EMOSTATICA.....	104	NEFF COLTELLO PER MENISCO.....	292	PARK BLEFAROSTATO.....	371
MICROPINZA CHIRURGICA, GOMEL.....	96	NEGUS PINZA PER TONSILLE.....	467	PARKER DIVARICATORE.....	139
MICROVASCULAR PORT'AGHI.....	210	NEGUS SUPPORTO PER PETTO.....	459	PARTSCH MARTELLO.....	271
MIDDELDORPF DIVARICATORE.....	160	NEIVERT PORT'AGHI.....	208	PARTSCH SCALPELLO.....	259
MIDDLETON-JANSEN PINZA PER SETTO NASALE.....	430	NEIVERT-ANDERSON OSTEOTOMO NASALE.....	442	PARTSCH SGORBIA.....	259
MIKRO COLTELLO FALCATO.....	475	NELATON SPECILLO SCANALATO.....	199	PASSOW PESTELLO DA TAMPONARE.....	260
MIKRO SEPERATORE.....	475	NELSON AGO PER LEGATURE.....	219	PATON DISETTORE CORNEALE.....	373
MIKRO UNCINO.....	475	NELSON STANDARD TREQUARTO.....	204	PAUFIQUE COLTELLO PER CHERATOPLASTICA.....	373
MIKRO-PINZA AURICOLARE.....	413	NELSON TREQUARTO.....	205	PAUFIQUE PINZA PER FILO.....	392
MIKRO-PINZA AURICOLARE, COS.....	414	NEONATAL PINZA VASCOLARE CASTANEDA.....	527	PAYR SCHIACCIATORE PER L'INTESTINO E LO	
MIKRO-PINZA AURICOLARE, DIETER.....	414	NEWS DIVARICATORE TRACHEALE.....	477	STOMACO.....	548
MIKRO-PINZA AURICOLARE, GREVEN.....	414	NISSEN PINZA EMOSTATICA.....	113	PAYR SPECILLO DI GUIDA SCANALATO.....	221
MIKRO-PINZA AURICOLARE, HAUGH.....	414	NORFOLK-NORWICH DIVARICATORE.....	172	PEAN PINZA DA PRESA.....	110
MIKRO-PINZA AURICOLARE, JUERS.....	414	NORTHBENT FORBICI PER LEGATURE.....	66	PEAN PINZA EMOSTATICA.....	108
MIKRO-PINZA AURICOLARE, MCGEE.....	414	NOTO PINZA PER POLIPI UTERINI.....	585	PECK-JOSEPH FACE LIFT FORBICI.....	74
MIKULICZ DIVARICATORE.....	163	NOVA, SFIGMOMANOMETRO.....	6.7	PECK-JOSEPH FACE LIFT FORBICI.....	74
MIKULICZ PINZA INTESTINALE.....	543	NOVAK CURETTA PER BIOPSIA.....	587	PEDERSON SPECOLO VAGINALE.....	570
MIKULICZ PINZA PERITONEALE.....	123	NOYES FORBICI OCULISTICHE.....	75	PEENFIELD DISETTORE.....	333
MIKULICZ-BABY PINZA PERITONEALE.....	123	NOYES PINZA PER POLIPI.....	425	PEERS PINZA FISSATELI.....	132
MILLER LARINGOSCOPIO.....	30			PEET PINZA PER SCHEGGE.....	92
MILLER RASPA NASALE.....	444	O		PEET RASPA NASALE.....	446
MILLIGAN DURA DISETTORE.....	332	OBWEGESER AGO DI INTRODUZIONE.....	463	PELKMANN PINZA PER MEDICATURA.....	137
MILLIN DIVARICATORE VESCICALE.....	552	OBWEGESER AGO DI INTRODUZIONE.....	463/3	PELVIMETRO, COLLIER.....	605
MILLIN DIVARICATORE VESCICALE.....	553	OBWEGESER DIVARICATORE.....	460, 461	PELVIMETRO, COLLIN.....	605
MILLIN PINZA CAPSULARE DA PRESA.....	551	OBWEGESER OSTEOTOMO A LAMA.....	464/1	PELVIMETRO, MARTIN.....	605
MILLIN PINZA DA PRESA PER LA PROSTATA.....	551	OBWEGESER PERIOSTOTOMO.....	461, 462, 463	PENNINGTON ELEVATORE PER SETTO.....	438
MINI MANICO CON ATTACCO RAPIDO.....	301	OCCHIALI NISTAGMO FRENZEL.....	20	PENNINGTON PINZA EMOSTATICA.....	109
MINI-LAMBOTTE OSTEOTOMO.....	262	OCHSNER TREQUARTO.....	205	PERCY RETRATTORE.....	296
MINIMUS II, SFIGMOMANOMETRO.....	11	O'CONNER UNCINO PER IRIDE.....	375	PERFORATORE A MANO, BUNELL.....	299
MINIMUS III, SFIGMOMANOMETRO.....	12	OEHLER PINZA CHIRURGICA.....	81/1	PERFORATORE A MANO, HUDSON KPLT.....	299
MIXTER PINZA CURVA AD "S".....	116	OLDBERG PINZA TAGLIANTE PER LAMINECTOMIA.....	341	PERFORATORE A MANO, KIRSCHNER.....	299
MIXTER PINZA PER CALCOLI BILIARI.....	531	OLIO PER STRUMENTI INSTRU CARE.....	634	PERFORATORE A MANO, MOORE.....	298
MIXTER-BABY PINZA EMOSTATICA.....	119/1	OLIVA NASALE POLITZER.....	406	PERFORATORE A MANO, RALK.....	300
MIXTER-O'SHAUGNESSY PINZA EMOSTATICA.....	119/2	OLIVECRONA DURA DISETTORE.....	332	PERFORATORE A MANO, STILLE.....	298
MOD. BONN PINZA PER IRIDE.....	387	OLIVECRONA PINZA SGORBIA.....	237	PERFORATORE A MANO, STILLE-SHERMAN.....	298
MOD. TÜBINGEN PINZA PER IRIDE.....	387	OLIVECRONA SEGA IN FILO D'ACCIAIO.....	332	PERFORATORE ELICOIDALE.....	302
MOD.MÜNCHEN CURETTA PER BIOPSIA.....	587	OLIVECRONA SPATOLA CEREBRALE.....	336	PERFORATORE INTRAMIDOLLARE.....	322
MOD.VIENNA SPECOLO NASALE.....	421	OLIVECRONA-TOENNIS (SCOVILLE).....	326	PERFORATORE, CRUTCHFIELD.....	327
MODELLATORE PER CHIODI, BENDER.....	322	OLIVECRONA-TOENNIS PINZA POSA CLIPS.....	326	PERFORATORE, CUSHING.....	299
MODELLO RUSSO, PINZA DA PRESA.....	85	OLLIER DIVARICATORE.....	162	PERFORATORE, ERRICO.....	299
MODELLO STRASSBURG PINZA CHIRURGICA.....	89	OLSEN-HEGAR PORT'AGHI.....	212	PERFORATORE, MC KENZIE.....	299
MOELTGEN GONIOMETRO.....	25	OMBREDANNE MARTELLO.....	273	PERFORATORE, SMELLIE.....	607
MOGEN STRUMENTO PER CIRCONCISIONE.....	556	OSTEOTOME, COTTLE.....	440	PERFORATORI FILIFORME KIRSCHNER.....	306, 307
MOLLISON DIVARICATORE.....	171	OSTEOTOMI.....	259	PERIOSTOTOMO.....	279
MOLT PERIOSTOTOMO.....	276	OSTEOTOMI.....	464	PERIOSTOTOMO MOLT.....	276
MONOPOLAR ELEKTRODEN ANSAN.....	628, 629	OSTEOTOMI EPKER.....	464/2	PERIOSTOTOMO SELDIN.....	277
MOOR CUCCHIAIO PER CALCOLI BILIARI.....	532	OSTEOTOMO A LAMA OBWEGESER.....	464/1	PERIOSTOTOMO, ADSON.....	282
MOORE PERFORATORE A MANO.....	298	OSTEOTOMO LEXER.....	263	PERIOSTOTOMO, ALEXANDER.....	276
MOORFIELD PINZA PER SUTURA.....	392	OSTEOTOMO MINI-LAMBOTTE.....	262	PERIOSTOTOMO, COBB.....	280
MORGAN PROCTOSCOPIO.....	565	OSTEOTOMO NASALE NEIVERT-ANDERSON.....	442	PERIOSTOTOMO, DINGMANN.....	463
MORITZ-SCHMIDT ABBASSALINGUA.....	452	OSTEOTOMO PER SETTO, COTTLE.....	440	PERIOSTOTOMO, DOYEN.....	278
MORRIS DIVARICATORE.....	164	OSTEOTOMO PER SETTO, FOMON.....	441	PERIOSTOTOMO, FARABEUF.....	274
MORRIS-DEBAKEY PINZA AORTA.....	506	OSTEOTOMO PER SETTO, SHEEHAN.....	441	PERIOSTOTOMO, FARABEUF-COLLIN.....	274
MORSE DIVARICATORE COSTALE.....	484	OSTEOTOMO, HIBBS.....	265	PERIOSTOTOMO, FOMON.....	277
MORSE-FAVALORO DIVARICATORE COSTALE.....	484	OSTEOTOMO, LAMBOTTE.....	261	PERIOSTOTOMO, JOSEPH.....	277
MORSETTO PER SISTEMA BRACCIO.....	189	OSTEOTOMO, SMITH-PETERSEN.....	261	PERIOSTOTOMO, KOENIG.....	276
MOYNIHAN PINZA EMOSTATICA.....	120	OSTEOTOMO, STILLE.....	260	PERIOSTOTOMO, LAMBOTTE.....	274
MOYNIHAN PINZA FISSATELI.....	133	OSTEOTOMO PER SETTO RUBIN.....	440	PERIOSTOTOMO, LANGENBECK.....	275
MOYNIHAN SONDA PER CALCOLI BILIARI.....	532	OSTROEM PINZA TAGLIANTE PER SETTO NASALE.....	430	PERIOSTOTOMO, MATSON.....	279
MUELLER BLEFAROSTATO.....	371	OSTROEM PINZA TAGLIANTE PER SETTO NASALE.....	430	PERIOSTOTOMO, MATSON-ALEXANDER.....	279
MÜLLER CLIPS PER VASI.....	364, 365	O'SULLIVAN-O'CONNOR DIVARICATORE		PERIOSTOTOMO, OBWEGESER.....	461, 462, 463
MURDOCK BLEFAROSTATO.....	370	ADDOMINALE.....	181	PERIOSTOTOMO, SEMB.....	278
MURPHY DIVARICATORE.....	156	O'SULLIVAN-O'CONNOR DIVARICATORE		PERIOSTOTOMO, WILLIGER.....	276
MURPHY-LANE ELEVATORE.....	283	ADDOMINALE.....	181	PERKINS DIVARICATORE.....	168

PERTHES LESINA.....	304	PINZA CHIRURGICA, ADSON-BROWN	82	PINZA EMOSTATICA, KELLY-RANKIN	106
PESTALOZZA CURETTA PER ABORTO	606	PINZA CHIRURGICA, BONNEY	88	PINZA EMOSTATICA, LAHEY	119/2
PESTELLO DA TAMPONARE, PASSOW	260	PINZA CHIRURGICA, BROPHY	84	PINZA EMOSTATICA, LAWRENCE	119
PETZ APPARECCHIATURA DI SUTURA		PINZA CHIRURGICA, CUSHING	83	PINZA EMOSTATICA, LERICHE	111
GASTRO-INTESTINALE	549	PINZA CHIRURGICA, FERRIS-SMITH	84	PINZA EMOSTATICA, LOVELACE	109
PHANEUF PINZA PERITONEALE	123	PINZA CHIRURGICA, GILLIES	86	PINZA EMOSTATICA, LOWER	120
PIERCE ELEVATORE PER SETTO	438	PINZA CHIRURGICA, LANE	84	PINZA EMOSTATICA, MAYO-GUYON	122
PIERCE TREQUARTO PER SENO MASCELLARE	204	PINZA CHIRURGICA, MCINDOE	85	PINZA EMOSTATICA, MEEKER	119
PIFFARD CURETTA PER LUPUS	608	PINZA CHIRURGICA, MOD.USA	81/1	PINZA EMOSTATICA, MICRO-HARTMANN	104
PILLING PINZA APPLICATORE CLIPS SMAL	524, 525	PINZA CHIRURGICA, OEHLER TC	81/1	PINZA EMOSTATICA, MIXTER	119/1
PINARD STETOSCOPIO	23	PINZA CHIRURGICA, SEMKEN	86	PINZA EMOSTATICA, MIXTER-BABY	119/1
PINZA PER CORPI ESTRANEI, HARTMANN	412	PINZA CHIRURGICA, STILLE	81/1	PINZA EMOSTATICA, MOYNIHAN	120
PINZA PER CORPI ESTRANEI,		PINZA CHIRURGICA, TAYLOR	87	PINZA EMOSTATICA, O'SHAUGNESSY	119/2
HARTMANN-HOFFMANN	412	PINZA COPERCHIO REDA	615	PINZA EMOSTATICA, PENNINGTON	109
PINZA PER CORPI ESTRANEI,		PINZA CURVA AD "S" MIXTER	116	PINZA EMOSTATICA, PROVIDENCE-HOSPITAL	106
HARTMANN-WULLSTEIN	412	PINZA DA PRESA	316,317	PINZA EMOSTATICA, ROBERTS	117
PINZA VASCOLARE, WANGENSTEEN	89	PINZA DA PRESA COTTLE	410	PINZA EMOSTATICA, ROCHESTER-CARMALT	109
PINZA AD ASTA TUBOLARE PER MICROCHIRURGIA	474	PINZA DA PRESA PER FILI KIRSCHNER	305	PINZA EMOSTATICA, ROCHESTER-OCHSNER	108
PINZA ANATOMICA STANDARD	81	PINZA DA PRESA PER LA PROSTATA, MILLIN	551	PINZA EMOSTATICA, ROCHESTER-PEAN	108
PINZA ANATOMICA, ADSON	82	PINZA DA PRESA PER TONSILLE ABRAHAM	468	PINZA EMOSTATICA, RUMEL	117
PINZA ANATOMICA, ADSON MICRO	82	PINZA DA PRESA PER TUMORI, LANDOLT	341	PINZA EMOSTATICA, SAROT	118
PINZA ANATOMICA, BONNEY	88	PINZA DA PRESA, COLLIN-DUVAL	85	PINZA EMOSTATICA, SPENCER-WELLS	109
PINZA ANATOMICA, BONNEY	88	PINZA DA PRESA, DURANTE	88	PINZA EMOSTATICA, STILLE	122
PINZA ANATOMICA, BROPHY	84	PINZA DA PRESA, DUVAL	85	PINZA EMOSTATICA, TOENNIS	117
PINZA ANATOMICA, CUSHING	83	PINZA DA PRESA, GRAFFE	83	PINZA EMOSTATICA, ZENKER	118
PINZA ANATOMICA, GERALD	86	PINZA DA PRESA, LERCHE	83	PINZA EMOSTATICA, OVERHOLT-BABY	114
PINZA ANATOMICA, MCINDOE	85	PINZA DA PRESA, MARTEL	110	PINZA EMOSTATICA, OVERHOLT-GEISSENDORFER	114
PINZA ANATOMICA, BONNEY	88	PINZA DA PRESA, MODELLO RUSSO	85	PINZA EMOSTATICA, OVERHOLT-MIXTER	115
PINZA ANATOMICA, POTTS-SMITH	81	PINZA DA PRESA, PEAN	110	PINZA FISSATELI	133
PINZA ANATOMICA, SEMKEN	86	PINZA DA PRESA, PRATT	110	PINZA FISSATELI BALL AND SOCKET	133
PINZA ANATOMICA, STILLE	81	PINZA DA PRESA, WILLET MARTEL	110	PINZA FISSATELI, BACKHAUS	132
PINZA ANATOMICA, TAYLOR	87	PINZA DENTALE LONDON-COLLEGE	93	PINZA FISSATELI, BERNHARD	133
PINZA ANATOMICA, TC	81	PINZA DENTALE MERIAM	93	PINZA FISSATELI, DOYEN	133
PINZA ANEURISMA DEBAKEY-BAHNSON	506	PINZA DEPILATORIA BEER	395	PINZA FISSATELI, JONES	132
PINZA AORTA DIETRICH	510	PINZA DEPILATORIA, BARRAQUER	395	PINZA FISSATELI, LANE	133
PINZA AORTA MORRIS-DEBAKEY	506	PINZA DEPILATORIA, DOUGLAS	395	PINZA FISSATELI, LORNA	133
PINZA ATRAUMATICA BULLDOG, DE BAKEY	100	PINZA DEPILATORIA, GRADLE	395	PINZA FISSATELI, MOYNIHAN	133
PINZA ATRAUMATICA BULLDOG, GLOVER	100	PINZA DEPILATORIA, LITTAUER	395	PINZA FISSATELI, PEERS	132
PINZA ATRAUMATICA IN TITANIO, DEBAKEY	99	PINZA DEPILATORIA, REDA	395	PINZA FISSATELI, ROEDER	132
PINZA ATRAUMATICA PER NEONATI E BAMBINI	523	PINZA EMORROIDALE FERGUSON	109	PINZA FISSATELI, SCHADEL	132
PINZA ATRAUMATICA TC DEBAKEY	99	PINZA EMORROIDALE, MCGIVNEY	568	PINZA FISSATELI, TOHOKU	132
PINZA AURICOLARE, HARTMANN	411	PINZA EMOSTATICA BIRKETT	116	PINZA FISSATRICE, BARRAQUER	390
PINZA AURICOLARE, HEYMANN-KNIGHT	425	PINZA EMOSTATICA BRIDGE	116	PINZA FISSATRICE, CASTROVIEJO	390
PINZA AURICOLARE, JANSEN	424	PINZA EMOSTATICA COLLER-CRILE	106	PINZA FISSATRICE, ELSCHNIG	389
PINZA AURICOLARE, LITTAUER	411	PINZA EMOSTATICA DEBAKEY-MOSQUITO	509	PINZA FISSATRICE, GRAEFE	389
PINZA AURICOLARE, LUCAE	410	PINZA EMOSTATICA DEBAKEY-PEAN	513	PINZA FISSATRICE, GREEN	390
PINZA AURICOLARE, TILLEY	411	PINZA EMOSTATICA DEBAKEY-RANKIN	512	PINZA FISSATRICE, LESTER	389
PINZA AURICOLARE, TROELTSCH	424	PINZA EMOSTATICA FUCHSIG	113	PINZA INTESTINALE BRUNNER	543
PINZA AURICOLARE, WILDE (TROELTSCH)	410	PINZA EMOSTATICA KANTROWITZ	119/1	PINZA INTESTINALE PER BIOPSIA, TURREL	567
PINZA AURICOLA, HARKEN	503	PINZA EMOSTATICA KOCHER	108	PINZA INTESTINALE PER BIOPSIA, YEOMAN	566, 567
PINZA BIPOLARE	630, 631	PINZA EMOSTATICA NISSEN	113	PINZA INTESTINALE SCUDDER	541
PINZA BIPOLARE A BAIONETTA	631, 632	PINZA EMOSTATICA OVERHOLT	114	PINZA INTESTINALE, BABY-KOCHER	540
PINZA CAPSULARE DA PRESA, MILLIN	551	PINZA EMOSTATICA PEAN	108	PINZA INTESTINALE, DOYEN	540
PINZA CAPSULARE, ARRUGA	391	PINZA EMOSTATICA WIKSTROEM	117	PINZA INTESTINALE, FEHLAND	542
PINZA CAPSULARE, CASTROVIEJO	391	PINZA EMOSTATICA, ADSON	112	PINZA INTESTINALE, KOCHER	540
PINZA CAPSULARE, ELSCHNIG	391	PINZA EMOSTATICA, ADSON-BABY	113	PINZA INTESTINALE, MAYO-ROBSON	541
PINZA CAPSULARE, FUCHS	391	PINZA EMOSTATICA, BAINBRIDGE	119/2	PINZA INTESTINALE, MIKULICZ	543
PINZA CAPSULARE, GILL-ARRUGA	390	PINZA EMOSTATICA, BENGOLEA	112	PINZA INTESTINALE, RESANO	542
PINZA CAPSULARE, HESS	391	PINZA EMOSTATICA, CRAFOORD	118	PINZA INTESTINALE, STONE-WATT	545
PINZA CAPSULARE, KALT	391	PINZA EMOSTATICA, CRAFOORD-SELLORS	119	PINZA MAYO	89
PINZA CAPSULARE, SCHWEIGGER	391	PINZA EMOSTATICA, CRILE	107	PINZA MODELLO STRASSBURG	89
PINZA CAPSULARE, TERSON	391	PINZA EMOSTATICA, CRILE-RANKIN	107	PINZA MUSCOLARE, BERKE	389
PINZA CARDIOVASCOLARE ATRAUMATICA	526	PINZA EMOSTATICA, DANDY	109	PINZA MUSCOLARE, MASTIN	479
PINZA CARDIOVASCOLARE ATRAUMATICA COOLEY	518, 519, 522	PINZA EMOSTATICA, DESJARDINS	121	PINZA MUSCOLARE, PRINCE	387
PINZA CARDIOVASCOLARE ATRAUMATICA DERRA	515	PINZA EMOSTATICA, GEMINI	115	PINZA NASALE GRAIG	426
PINZA CARDIOVASCOLARE ATRAUMATICA GREGORY	517	PINZA EMOSTATICA, GRAY	121	PINZA NASALE PER TAMPONI LUBET-BARBON	424
PINZA CHIRURGICA GERALD	87	PINZA EMOSTATICA, GUYON	122	PINZA NASALE PER TAMPONI WESTMACOTT	424
PINZA CHIRURGICA POTTS SMITH	81	PINZA EMOSTATICA, HALSTED-MOSQUITO	105	PINZA NASALE WEIL-BLAKESLEY	426
PINZA CHIRURGICA STANDARD	81/1	PINZA EMOSTATICA, HARTMANN	104	PINZA NASALE, CAPLAN	428
PINZA CHIRURGICA WAUGH	83	PINZA EMOSTATICA, HEISS	112	PINZA NASALE, HARTMANN	427
PINZA CHIRURGICA, ADSON	82	PINZA EMOSTATICA, JACOBSON	105	PINZA NASALE, MYLES	427
PINZA CHIRURGICA, ADSON MICRO	82	PINZA EMOSTATICA, JOHNS-HOPKINS	120	PINZA NASALE, SCHMEDEN	427
		PINZA EMOSTATICA, KELLY	106	PINZA NASALE, TAKAHASHI	427

PINZA NASALE, WATSON-WILLIAMS.....	428	PINZA PER AGRAFES, RICHTER-HEATH	224	PINZA PER IRIDE, GRAEFEE.....	382
PINZA NASALE, STRUYCKEN.....	427	PINZA PER ANASTOMOSI DEL RETTO, HAYES	545	PINZA PER IRIDE, HESS	384
PINZA OMBELICALE, COLLIN.....	605	PINZA PER ANASTOMOSI, BECK	516	PINZA PER IRIDE, KIRBY-ARTHUR.....	385
PINZA OMBELICALE, KANE.....	605	PINZA PER ANASTOMOSI, BECK	520	PINZA PER IRIDE, MOD. BONN.....	387
PINZA PER ABBASSARE IL COLLO DELL'UTERO CZERNY	584	PINZA PER ANASTOMOSI, COOLEY-DERRA	519	PINZA PER IRIDE, MOD. TUEBINGEN	387
PINZA PER ABBASSARE IL COLLO DELL'UTERO SCHRÖDER	583, 584	PINZA PER ANASTOMOSI, DE MARTEL-WOLFSON	546	PINZA PER IRIDE, TROUTMAN.....	389
PINZA PER ABBASSARE IL COLLO DELL'UTERO, BARRET.....	582	PINZA PER ANASTOMOSI, DEBAKEY	505	PINZA PER IRIDE, STEVENS	383
PINZA PER ABBASSARE IL COLLO DELL'UTERO, BRAUN	582	PINZA PER ANASTOMOSI, LAMBERT-KAY	505	PINZA PER ISTERECTOMIA SEGOND.....	125
PINZA PER ABBASSARE IL COLLO DELL'UTERO, DUPLAY	582	PINZA PER AORTA PEDIATRICA, SUBRAMANIAN-MINIATURE	521	PINZA PER ISTERECTOMIA SEGOND-LANDAU	125
PINZA PER ABBASSARE IL COLLO DELL'UTERO, HULKA.....	583	PINZA PER AORTA, WEBER.....	501	PINZA PER ISTERECTOMIA, HEANEY	126
PINZA PER ABBASSARE IL COLLO DELL'UTERO, IOWA	584	PINZA PER APPENDICE, ALLEN.....	544	PINZA PER ISTERECTOMIA, HEANY-BALLENTINE.....	127
PINZA PER ABBASSARE IL COLLO DELL'UTERO, JACOBS	583	PINZA PER APPENDICE, KLEINSCHMIDT.....	544	PINZA PER ISTERECTOMIA, ROGERS	127
PINZA PER ABBASSARE IL COLLO DELL'UTERO, JARCHO.....	583	PINZA PER BIOPSIA BABY BURKE	590	PINZA PER ISTERECTOMIA, WERTHERS	124
PINZA PER ABBASSARE IL COLLO DELL'UTERO, MUSEUX.....	583	PINZA PER BIOPSIA BABY TISCHLER	592	PINZA PER ISTERECTOMIA, WERTHEIM	128
PINZA PER ABBASSARE IL COLLO DELL'UTERO, PRATT	584	PINZA PER BIOPSIA SCHUMACHER	588, 589	PINZA PER LACERAZIONE UNGHIE, RADOLF	297
PINZA PER ABBASSARE IL COLLO DELL'UTERO, SCHROEDER	583, 584	PINZA PER BIOPSIA TOWNSEND.....	591	PINZA PER MEDICATURA.....	135
PINZA PER ABBASSARE IL COLLO DELL'UTERO, SCHROEDER (POZZI).....	582	PINZA PER BIOPSIA, ALEXANDER	589	PINZA PER MEDICATURA, BRYANT	137
PINZA PER ABBASSARE IL COLLO DELL'UTERO, SKENE.....	582	PINZA PER BIOPSIA, BURKE.....	590	PINZA PER MEDICATURA, CHERON.....	137
PINZA PER ABBASSARE IL COLLO DELL'UTERO, TEALE.....	583	PINZA PER BIOPSIA, BURKE.....	590	PINZA PER MEDICATURA, COLLIN.....	137
PINZA PER ABBASSARE IL COLLO DELL'UTERO, STAUDE-MOORE	582	PINZA PER BIOPSIA, EPPENDORFER.....	590	PINZA PER MEDICATURA, DUPLAY	134
PINZA PER ABORTO, SAENGER	606	PINZA PER BIOPSIA, FAURE	588	PINZA PER MEDICATURA, FOERSTER	136
PINZA PER ABORTO, WINTER.....	606	PINZA PER BIOPSIA, KEVORK-PACIFIC.....	592	PINZA PER MEDICATURA, GROSS-MAIER.....	134
PINZA PER AFFERRARE IL POLMONE, LOVELACE	490	PINZA PER BIOPSIA, KEVORKIAN.....	589	PINZA PER MEDICATURA, LISTER (SINUS).....	137
PINZA PER AFFERRARE INTESTINI DOYEN-BABY	540	PINZA PER BIOPSIA, KEVORKIAN.....	591	PINZA PER MEDICATURA, PELKMANN.....	137
PINZA PER AFFERRARE INTESTINI LOCKWOOD-ALLIS	538	PINZA PER BIOPSIA, MAXI GRASPER	593	PINZA PER MEDICATURA, RAMPLEY	136
PINZA PER AFFERRARE INTESTINI, ALLIS	537	PINZA PER BIOPSIA, SCHUBERT	588	PINZA PER MEDICATURA, SIMS-MAIER.....	134
PINZA PER AFFERRARE INTESTINI, ALLIS-ADAIR	537	PINZA PER BIOPSIA, THOMAS-GAYLOR	588	PINZA PER MEDICATURA, ULRICH	135
PINZA PER AFFERRARE INTESTINI, ALLIS-BABY	537	PINZA PER BIOPSIA, TISCHLER	591	PINZA PER MICROCHIRURGIA.....	94
PINZA PER AFFERRARE INTESTINI, ATRAUMA	111	PINZA PER BIOPSIA, TISCHLER-KEVORK.....	592	PINZA PER OCCLUSIONE TANGENZIALE, DEBAKEY-SATINSKY	502
PINZA PER AFFERRARE INTESTINI, BABCOCK	539	PINZA PER BIOPSIA, TISCHLER-MORGAN	590, 591	PINZA PER OSSA LAMBERT-LOWMAN.....	249
PINZA PER AFFERRARE INTESTINI, COLLIN.....	539	PINZA PER BIOPSIA, VAN DOREN	588	PINZA PER OSSA, FELDHEIM.....	249
PINZA PER AFFERRARE INTESTINI, DUVAL	539	PINZA PER BIOPSIA, WITTNER	589	PINZA PER OSSA, GERSTMAN.....	250
PINZA PER AFFERRARE INTESTINI, JUDD-ALLIS	538	PINZA PER BIOPSIA, TISCHLER-MORGAN	590	PINZA PER OSSA, LOWMAN.....	249
PINZA PER AFFERRARE INTESTINI, LITTLEWOOD.....	538	PINZA PER BRONCHI, FINOCCHIETTO	490	PINZA PER OSSA, LOWMAN-HOGLUND.....	249
PINZA PER AFFERRARE INTESTINI, THOMS-ALLIS.....	538	PINZA PER BRONCHI, HARRINGTON.....	490	PINZA PER OSSA, LOWMAN.....	248
PINZA PER AFFERRARE INTESTINI, WILLIAMS.....	539	PINZA PER BRONCHI, LEES.....	504	PINZA PER OSSA, LOWMAN-HOGLUND.....	249
PINZA PER AFFERRARE L'UTERO, COLLIN.....	585	PINZA PER BRONCHI, PRICE-THOMAS	490	PINZA PER OSSA, LOWMAN-HOGLUND.....	249
PINZA PER AFFERRARE L'UTERO, DARTIGUES.....	585	PINZA PER BRONCHI, SEMB	491	PINZA PER OSSA, LOWMAN-HOGLUND.....	249
PINZA PER AFFERRARE L'UTERO, SOMER.....	585	PINZA PER BRONCO-ESOFAGOSCOPIA, CHEVALIER-JACK.....	473	PINZA PER OSSA, LOWMAN-HOGLUND.....	249
PINZA PER AFFERRARE TENDINI.....	293	PINZA PER CALAZIO, AYER.....	393	PINZA PER OSSA, LOWMAN-HOGLUND.....	249
PINZA PER AFFERRARE TENDINI JACKSON	292	PINZA PER CALAZIO, DESMARRÉS.....	393	PINZA PER OSSA, LOWMAN-HOGLUND.....	249
PINZA PER AFFERRARE TENDINI KLEINERT-KUTZ	294	PINZA PER CALAZIO, LAMBERT	393	PINZA PER OSSA, LOWMAN-HOGLUND.....	249
PINZA PER AFFERRARE TENDINI, BRAND	293	PINZA PER CALCOLI BILIARI BLAKE	531	PINZA PER OSSA, LOWMAN-HOGLUND.....	249
PINZA PER AFFERRARE TENDINI, CAROLL.....	293	PINZA PER CALCOLI BILIARI DESJARDINS	531	PINZA PER OSSA, LOWMAN-HOGLUND.....	249
PINZA PER AFFERRARE TENDINI, LARSEN.....	292	PINZA PER CALCOLI BILIARI MAYO-BLAKE	531	PINZA PER OSSA, LOWMAN-HOGLUND.....	249
PINZA PER AFFERRARE TENDINI, STEINMANN.....	292	PINZA PER CALCOLI BILIARI MIXTER	531	PINZA PER OSSA, LOWMAN-HOGLUND.....	249
PINZA PER AFFERRARE TESSUTI, BROWN	83	PINZA PER CALCOLI RENALI, HEIMING	536	PINZA PER OSSA, LOWMAN-HOGLUND.....	249
PINZA PER AFFERRARE TESSUTI, CHAPUT	110	PINZA PER CALCOLI RENALI, RANDALL	535	PINZA PER OSSA, LOWMAN-HOGLUND.....	249
PINZA PER AFFERRARE TESSUTI, COLLIN.....	110	PINZA PER CAROTIDE JAVID	511	PINZA PER OSSA, LOWMAN-HOGLUND.....	249
PINZA PER AFFERRARE TESSUTI, SINGLEY.....	88	PINZA PER CATETERI COOLEY	510	PINZA PER OSSA, LOWMAN-HOGLUND.....	249
PINZA PER AFFERRARE TESSUTI, TUFFIER	110	PINZA PER COARTAZIONE E ANASTOMOSI POTTS	492, 493	PINZA PER OSSA, LOWMAN-HOGLUND.....	249
PINZA PER AGRAFES, CHILDE.....	224	PINZA PER CORPI ESTRANEI STRUEMPEL	412	PINZA PER OSSA, LOWMAN-HOGLUND.....	249
PINZA PER AGRAFES, COLLIN.....	224	PINZA PER CORPI ESTRANEI, MATHIEU	553/1	PINZA PER OSSA, LOWMAN-HOGLUND.....	249
PINZA PER AGRAFES, HEGENBARTH	224	PINZA PER CRANIOTOMIA CONE	331	PINZA PER OSSA, LOWMAN-HOGLUND.....	249
PINZA PER AGRAFES, MICHEL.....	224	PINZA PER EMORROIDI, HEYWOOD-SMITH	567	PINZA PER OSSA, LOWMAN-HOGLUND.....	249
PINZA PER AGRAFES, WACHENFELDT.....	224	PINZA PER FILO, MCPHERSON	392	PINZA PER OSSA, LOWMAN-HOGLUND.....	249
		PINZA PER FILO, MOD. TUEBINGEN	392	PINZA PER OSSA, LOWMAN-HOGLUND.....	249
		PINZA PER FILO, PAUFIQUE.....	392	PINZA PER OSSA, LOWMAN-HOGLUND.....	249
		PINZA PER GOZZO, LAHEY.....	479	PINZA PER OSSA, LOWMAN-HOGLUND.....	249
		PINZA PER IL CUIOIO CAPELLUTO, GAUSS	605	PINZA PER OSSA, LOWMAN-HOGLUND.....	249
		PINZA PER INTRODUZIONE SONDE MAGILL	28	PINZA PER OSSA, LOWMAN-HOGLUND.....	249
		PINZA PER IPOFISI.....	341	PINZA PER OSSA, LOWMAN-HOGLUND.....	249
		PINZA PER IPOFISI, ADSON.....	334	PINZA PER OSSA, LOWMAN-HOGLUND.....	249
		PINZA PER IRIDE BARRAQUER (COLIBRI).....	384	PINZA PER OSSA, LOWMAN-HOGLUND.....	249
		PINZA PER IRIDE, BARRAQUER-KATZIN	384	PINZA PER OSSA, LOWMAN-HOGLUND.....	249
		PINZA PER IRIDE, BISHOP-HARMAN.....	386	PINZA PER OSSA, LOWMAN-HOGLUND.....	249
		PINZA PER IRIDE, BONN.....	387	PINZA PER OSSA, LOWMAN-HOGLUND.....	249
		PINZA PER IRIDE, FISCHER.....	384	PINZA PER OSSA, LOWMAN-HOGLUND.....	249
		PINZA PER IRIDE, FOERSTER	383	PINZA PER OSSA, LOWMAN-HOGLUND.....	249
		PINZA PER IRIDE, GILL.....	384	PINZA PER OSSA, LOWMAN-HOGLUND.....	249
		PINZA PER IRIDE, GILL-HESS	384	PINZA PER OSSA, LOWMAN-HOGLUND.....	249

PINZA PER STERILIZZAZIONE, UNIVERSAL.....	227	PINZA TAGLIENTE PER DISCHI INTERVERTEBRALI, FERRIS-SMITH-KERRISON.....	344, 344/2	PORT'AGHI, DE BAKEY.....	210
PINZA PER STRABISMO, BONACCOLTO.....	385	PINZA TAGLIENTE PER LAMINECTOMIA, CLOWARD.....	342	PORT'AGHI, DERF.....	208
PINZA PER STRABISMO, DASTOOR.....	386	PINZA TAGLIENTE PER LAMINECTOMIA, OLDBERG.....	341	PORT'AGHI, FINOCCHIETTO.....	211
PINZA PER STRABISMO, JAMESON.....	385	PINZA TAGLIENTE PER LAMINECTOMIA, SCHLESINGER.....	342	PORT'AGHI, GILLIES.....	212
PINZA PER STRABISMO, MCCULLOUGH.....	385	PINZA TAGLIENTE PER LAMINECTOMIA, SPURLING.....	340	PORT'AGHI, HALSEY.....	208
PINZA PER SUTURA, CASTROVIEJO.....	392	PINZA TAGLIENTE PER LAMINECTOMIA, WAGNER.....	343	PORT'AGHI, HALSEY.....	208
PINZA PER SUTURA, MOORFIELD.....	392	PINZA TAGLIENTE PER LAMINECTOMIA, CUSHING.....	340	PORT'AGHI, HEANEY.....	210
PINZA PER SUTURA, ST. MARTIN.....	392	PINZA TAGLIENTE PER LAMINECTOMIA, FERRIS-SMITH.....	343	PORT'AGHI, HOESEL.....	213
PINZA PER TAMPONI, BOZEMANN.....	138	PINZA TAGLIENTE PER LAMINECTOMIA, LOVE-GRUENWALD.....	340	PORT'AGHI, JOHNSON.....	215
PINZA PER TAMPONI, BOZEMANN-DOUGLAS.....	138	PINZA TAGLIENTE PER SETTO NASALE, CITELLI.....	430	PORT'AGHI, KALT-ARRUGA.....	214
PINZA PER TONSILLE COLVER.....	467	PINZA TIRALINGUA, COLLIN.....	453	PORT'AGHI, KILNER.....	212
PINZA PER TONSILLE, BALLENGER.....	467	PINZA TIRALINGUA, YOUNG.....	453	PORT'AGHI, LANGENBECK.....	213
PINZA PER TONSILLE, BLOHMKE.....	467	PINZA TORCIFILI, BERRY TC.....	319	PORT'AGHI, LICHTENBERG.....	213
PINZA PER TONSILLE, MARSCHIK.....	468	PINZA TORCIFILI, CORWIN-HEGAR TC.....	319	PORT'AGHI, MASSON.....	210
PINZA PER TONSILLE, NEGUS.....	467	PINZA TORCIFILI, MAYO-HABERISSER TC.....	319	PORT'AGHI, MATHIEU.....	213
PINZA PER TONSILLE, SAWTELL.....	467	PINZA ULTRA LIGHT.....	95	PORT'AGHI, MATHIEU-OLSEN.....	212
PINZA PER TONSILLE, SCHNIDT.....	467	PINZA UTERINA PER EMOSTASI, GREEN-ARMYTAGE.....	605	PORT'AGHI, MAYO-HEGAR.....	209
PINZA PER TONSILLE, TYDING.....	467, 468	PINZA VASCOLARE BAINBRIDGE.....	495	PORT'AGHI, METZENBAUM.....	211
PINZA PER TONSILLE, WHITE.....	467	PINZA VASCOLARE GLOVER.....	515	PORT'AGHI, NEIVERT.....	208
PINZA PER TRACOMA, KNAPP-LUER.....	393	PINZA VASCOLARE ADLERKREUTZ.....	84	PORT'AGHI, OLSEN-HEGAR.....	212
PINZA PER TRAZIONE CRANIALE, CRUTCHFIELD.....	327	PINZA VASCOLARE, DIEFFENBACH.....	104	PORT'AGHI, RYDER.....	210
PINZA PER TUMORI, YASARGIL.....	467	PINZA VASCOLARE, LELAND-JONES.....	494	PORT'AGHI, SAROT.....	211
PINZA PERITONEALE, FAURE.....	123	PINZA VASCOLARE, SATINSKY.....	491	PORT'AGHI, STEVENS.....	214
PINZA PERITONEALE, MIKULICZ, 20CM.....	123	PINZA VASCOLARE, STILLE-BARRAYA.....	88	PORT'AGHI, WANGENSTEEN.....	210
PINZA PERITONEALE, MIKULICZ-BABY.....	123	PINZA, DAVIS.....	227	PORT'AGHI, WEBSTER.....	208
PINZA PERITONEALE, PHANEUF.....	123	PINZE ATRAUMATICHE BULLDOG DE BAKEY.....	103	PORT'AGHI, BABY-OLSEN-HEG.....	212
PINZA PORTAPLACCHE, LANE.....	325	PINZE ATRAUMATICHE BULLDOG GLOVER.....	103	PORT'AGHI, STRATTE.....	212
PINZA PORTAVITI, LANE.....	325	PINZE ATRAUMATICHE BULLDOG IN TITANIO.....	102	PORTATORE DI LUCE FREDDA A FIBRE DI VETRO KLEINSASSER.....	36
PINZA POSA CLIPS BIEMER.....	361,363,364,366	PINZE ATRAUMATICHE, DE BAKEY.....	98	POSA CLIPS.....	357,358, 359, 360
PINZA POSA CLIPS, MEHDORN.....	362	PINZE PER SCHEGGE.....	90	POSA CLIPS JOHNS-HOPKINS.....	104
PINZA POSA CLIPS, RANEY.....	327	PIPER FORCIPE.....	604	POSA CLIPS, MC KENZIE.....	326
PINZA RENALE GUYON.....	122	PISTOLA LAVATRICE.....	626	POSA CLIPS, WANGENSTEEN.....	326
PINZA SERRAPENE, STOCKMANN.....	553/1	PISTONI.....	258, 259	POSA CLIPS, SWEET.....	326
PINZA SERRAPENE, STRAUSS.....	553/1	PISTONI CASPAR.....	258	POST MORTEM AGO.....	268
PINZA SERRATUBI.....	129	PLACCA PER PALPEBRE JAEGER.....	371	POTTS PINZA PER COARTAZIONE E ANASTOMOSI.....	492, 493
PINZA SERRATUBI, HOFFMANN.....	624	PLACCA PER STENDIPELLE.....	49	POTTS SMITH PINZA CHIRURGICA.....	81
PINZA SERRATUBI, SIMPLEX.....	624	PLESTER CANNULA D'ASPIRAZIONE.....	338	POTTS-DE MARTEL FORBICI VASCOLARI.....	59
PINZA SERRATUBI, BÜLOW-GUNAR-HEY.....	130	PLESTER COLTELLO.....	418	POTTS-SMITH FORBICI VASCOLARI.....	61
PINZA SFENOIDALE HAJEK-KOFLER.....	430, 431	PLESTER DIVARICATORE.....	171	POTTS-SMITH PINZA ANATOMICA.....	81
PINZA SGOBRIA BANE-HARTMANN.....	237	POLITZER AGO PER PARACENTESI.....	408	PRATT DILATATORE UTERINO.....	580
PINZA SGOBRIA MAYFIELD.....	238	POLITZER AGO PER PARACENTESI.....	408	PRATT PINZA DA PRESA.....	110
PINZA SGOBRIA SMITH-PETERSEN.....	238	POLITZER COLTELLO AURICOLARE.....	408	PRATT PINZA PER ABBASSARE IL COLLO DELL'UTERO.....	584
PINZA SGOBRIA, ADSON.....	236	POLITZER INSOFFIATORE D'ARIA.....	406	PRATT SPECILLO PER FISTOLE.....	563
PINZA SGOBRIA, BLUMENTHAL.....	236	POLITZER OLIVA NASALE.....	406	PRATT SPECILO RETTALE.....	559
PINZA SGOBRIA, BOEHLER.....	238	POLITZER SPECILO AURICOLARE.....	399	PRECISA SFIGMOMANOMETRO.....	9
PINZA SGOBRIA, CLEVELAND.....	235	POMPA D'ARIA.....	295	PRICE-THOMAS PINZA PER BRONCHI.....	490
PINZA SGOBRIA, ECHLIN.....	240	POOLE CANNULA D'ASPIRAZIONE.....	27	PRINCE FORBICI PER TONSILLE.....	59
PINZA SGOBRIA, FRIEDMAN-MICRO.....	234	PORTA AGRAFES.....	326	PRINCE PINZA MUSCOLARE.....	387
PINZA SGOBRIA, FRIEDMAN-MINI.....	234	PORTACOTONE, FARRELL.....	203	PROTEGGIDITA, LANGENBECK.....	311
PINZA SGOBRIA, FRYKHOLM.....	240	PORTACOTONE, JOBSON-HORNE.....	203	PROCTOSCOPO BENSAUDE.....	565
PINZA SGOBRIA, JANSEN.....	237	PORTACOTONE, REDA.....	203	PROCTOSCOPO MORGAN.....	565
PINZA SGOBRIA, KLEINERT-KUTZ.....	237	PORTACOTONE, TOBOLD.....	203	PROCTOSCOPO, CHELSEA-EATON.....	563
PINZA SGOBRIA, LEMPERS.....	237	PORTACOTONE, UCKERMANN.....	203	PROCTOSCOPO, FANSLER.....	565
PINZA SGOBRIA, LUER.....	236	PORT'AGHI BARRAQUER.....	216, 217	PROCTOSCOPO, KELLY.....	563
PINZA SGOBRIA, MARQUARDT.....	239	PORT'AGHI CASTROVIEJO.....	216	PROVIDENCE-HOSPITAL PINZA EMOSTATICA.....	106
PINZA SGOBRIA, MEAD.....	235	PORT'AGHI MICROVASCULAR.....	210	PUNTE PER SPECILLI.....	201
PINZA SGOBRIA, OLIVECRONA.....	237	PORT'AGHI, ADSON.....	211	PUTTI RASPA PER OSSA.....	294
PINZA SGOBRIA, RUSKIN.....	239	PORT'AGHI, ARRUGA.....	214		
PINZA SGOBRIA, SAUERBRUCH.....	240	PORT'AGHI, BABY-WEBSTER.....	208		
PINZA SGOBRIA, SCAGLIETTI.....	240	PORT'AGHI, BARRAQUER-TROUTMAN.....	216		
PINZA SGOBRIA, SEMB.....	240	PORT'AGHI, BAUMGARTNER.....	208		
PINZA SGOBRIA, STELLBRINK.....	234	PORT'AGHI, BOYNTON.....	214		
PINZA SGOBRIA, ZAUFAJ-JANSEN.....	238	PORT'AGHI, BOZEMANN.....	211		
PINZA SGOBRIA, LEKSELL-STILLE.....	240	PORT'AGHI, BROWN.....	209		
PINZA SGOBRIA, STILLE-LUER.....	239	PORT'AGHI, CASTROVIEJO.....	215		
PINZA SGOBRIA, STILLE-RUSKIN.....	239	PORT'AGHI, CASTROVIEJO MICRO.....	215		
PINZA STOMACALE LANE.....	547	PORT'AGHI, COLLIER, 12,5CM.....	208		
PINZA STRAPPAGESSI, WOLFF.....	233	PORT'AGHI, CRILE.....	213		
PINZA TAGLIENTE CIRCOLARE.....	432	PORT'AGHI, CRILE-MURRAY.....	209		
PINZA TAGLIENTE NASALE, KERRISON.....	428	PORT'AGHI, CRILE-WOOD TC.....	209		
PINZA TAGLIENTE PER CAPSULA, HOLTH.....	380				
PINZA TAGLIENTE PER DISCHI INTERVERTEBRALI, COLCLOUGH.....	344/1				

R			
RACCORDO DI LAVAGGIO.....	626	ROBB SPATOLA.....	530
RACHOTOMO.....	267	ROBERTS PINZA EMOSTATICA.....	117
RADOLF PINZA PER LACERAZIONE UNGHIE.....	297	ROCHARD DIVARICATORE ADDOMINALE.....	186
RAGNELL DIVARICATORE.....	140	ROCHARD SUPPORTO.....	186
RALK PERFORATORE A MANO.....	300	ROCHESTER-CARMALT.....	109
RAMPLEY PINZA PER MEDICATURA.....	136	ROCHESTER-OCHSNER PINZA EMOSTATICA.....	108
RAMUS DIVARICATORE.....	461	ROCHESTER-PEAN PINZA EMOSTATICA.....	108
RANDALL CURETTA PER BIOPSIA.....	587	ROEDER PINZA FISSATELI.....	132
RANDALL PINZA PER CALCOLI RENALI.....	535	ROGER ELEVATORE PER SETTO.....	437, 438
RANEY GRAFFA PER IL CUOIO CAPELLUTO.....	327	ROGERS PINZA PER ISTERECTOMIA.....	127
RANEY PINZA POSA CLIPS.....	327	ROGGE PINZA PER STERILIZZAZIONE.....	227
RASCHIATOIO CORNEALE, KUHN.....	373	ROLLET SCALPELLO ESTIRPATORE.....	374
RASOIO.....	49	ROLLET UNCINO DIVARICATORE.....	375
RASPA NASALE FOMON TC.....	445	ROMPILAMETTE, CASTROVIEJO.....	45
RASPA NASALE GALLAHER.....	446	ROMPILAMETTE, REDA.....	45
RASPA NASALE MILLER.....	444	ROMPILAMETTE, TROUTMAN-CHRIS.....	45
RASPA NASALE PEET.....	446	ROSE DIVARICATORE.....	140
RASPA NASALE, FOMON.....	444	ROSEN AGO.....	419
RASPA NASALE, JOSEPH.....	443	ROSEN CANNULA D'ASPIRAZIONE.....	338
RASPA NASALE, JOSEPH (LEWIS).....	443	ROSEN COLTELLO.....	418
RASPA NASALE, MALTZ.....	443	ROSER-KOENIG APRIBOCCA.....	454
RASPA NASALE, MALTZ (COTTLE).....	444	ROTATORE PER NUCLEO BECHERT.....	379
RASPA NASALE, WIENER.....	443	ROUX MINI DIVARICATORE.....	140
RASPA PER OSSA.....	294	ROUX DIVARICATORE.....	139
RASPA PER OSSA PUTTI.....	294	ROUX-BABY DIVARICATORE.....	140
RECAMIER CURETTE UTERINI.....	597	ROWE PINZA PER RIPOSIZIONE.....	459
RECIPIENTE CILINDRICO.....	620	RUBIN OSTEOTOMO PER SETTO.....	440
REDA DIAPASON.....	403	RUBIN PINZA PER SETTO NASALE.....	428
REDA CALAMITA OCULISTICA.....	395	RUDD LEGATORE EMORROIDALE.....	568
REDA COLTELLO FALCATO.....	435	RUMEL PINZA EMOSTATICA.....	117
REDA COLTELLO PER AMPUTAZIONE.....	44	RUMEL-BELMONT TOURNIQUET.....	528
REDA CURETTA TAGLIANTE.....	256	RUSKIN PINZA SGORBIA.....	239
REDA DIVARICATORE PER GESSI.....	232	RUSKIN-LISTON CESOIA PER OSSA.....	241
REDA EXCENTER FORBICI PER BENDAGGI.....	69/2	RUSSEL-DAVIS ABBASSALINGUA.....	458
REDA PERFORATORE A MANO.....	300	RYDEL-SEIFFERT DIAPASON.....	404
REDA PINZA COPERCHIO.....	615	RYDER PORT AGHI.....	210
REDA PINZA DEPILATORIA.....	395		
REDA PINZA PER AFFERRARE INTESTINI.....	111	S	
REDA PORTACOTONE.....	203	SAALFELD SCHIACCIACOMEDONI.....	608
REDA ROMPILAMETTE.....	45	SACHS DURA DISSETTORE.....	332
REDA SEGA TAGLIA ANELLI.....	297	SACHS UNCINO PER NERVI.....	329
REDA Sonda CONDUTTRICE A FORCHETTA.....	221	SAENGER PINZA PER ABORTO.....	606
REDA SPECOLO NASALE.....	423	SALPINGOGRAFO.SCHULTZE.....	596
REDA UNCINO PER LA PELLE.....	150	SANVENERO FORBICI PER CHIRURGIA.....	54
REDON AGO DI GUIDA.....	207	SAROT PINZA EMOSTATICA.....	118
REES FACE LIFT FORBICI.....	73	SAROT PORT AGHI.....	211
REGOLO DI METALLO.....	25	SATINSKY FORBICI VASCOLARI.....	65/2
REICHERT DEPRESSORE PER EPIGLOTTIDE.....	471	SATINSKY PINZA VASCOLARE.....	491
REILL TENAGLIA PER OSSA.....	248	SATO DISSETTORE CORNEALE.....	373
REINER COLTELLO PER GESSI.....	233	SATTERLEE SEGA PER AMPUTAZIONE.....	296
REINER SIRINGA AURICOLARE.....	406	SAUERBRUCH COSTOTOMO.....	481
RESANO PINZA INTESTINALE.....	542	SAUERBRUCH DIVARICATORE.....	164
RESANO, FORBICI PER CAPSULA.....	53/2	SAUERBRUCH DIVARICATORE.....	166
RETRATTATORE, PERCY.....	296	SAUERBRUCH PINZA PER RIFIUTI.....	227
RETRATTORI INTRAORALI.....	463/1	SAUERBRUCH PINZA SGORBIA.....	240
RETRATTORI INTRAORALI.....	463/4	SAUERBRUCH-FREY COSTOTOMO.....	481
REVERDIN AGO.....	220	SAWTELL PINZA PER TONSILLE.....	467
REVERDIN SPATOLA ADDOMINALE E INTESTINALE.....	143/1	SAWYER SPECOLO RETTALE.....	560
REYNOLDS FORBICI PER CHIRURGIA.....	54	SAYRE ELEVATORE.....	281
REYNOLDS SUPERSCUT FORBICI.....	72	SCAGLIETTI PINZA SGORBIA.....	240
RIBBON SPATOLA ADDOMINALE E INTESTINALE.....	143	SCALP-CONTOUR DIVARICATORE.....	169
RICARD DIVARICATORE ADDOMINALE.....	191	SCALPELLI.....	259
RICHARDSON DIVARICATORE.....	142	SCALPELLO ESTIRPATORE, ROLLET.....	374
RICHARDSON-EASTMAN DIVARICATORE.....	142	SCALPELLO PARTSCH.....	259
RICHARDSON-GRIP DIVARICATORE.....	142	SCALPELLO PER SETTO, CINELLI.....	441
RICHNAU-HOLMGREN SPECOLO AURICOLARE.....	400	SCALPELLO PER SETTO, COTTLE.....	440
RICHTER-HEATH PINZA PER AGRAFES.....	224	SCALPELLO PER SETTO, FREER.....	439
RIENHOFF-FINOCHIETTO DIVARICATORE COSTALE.....	486	SCALPELLO PER SETTO, SILVER.....	442
RIGBY DIVARICATORE ADDOMINALE.....	189/2	SCALPELLO, ALEXANDER.....	259
RI-MINI COMBINAZIONE PER DIAGNOSTICA		SCALPELLO, BRUNETTI.....	268
CON ILLUMINAZIONE ALOGENA.....	17	SCALPELLO, HIBBS.....	265
BITTER-HALLE DILATATORE PER SENSO FRONTALE.....	433	SCALPELLO, STILLE.....	260
		SCATOLA PER STERILIZZARE AGHI.....	615
		SCATOLA PER STERILIZZARE AGHI.....	615
		SCATOLA PER STRUMENTI.....	616, 617, 618
		SCHAEDEL PINZA FISSATELI.....	132
		SCHAMBERG SCHIACCIACOMEDONI.....	608
		SCHAEDE CURETTA TAGLIANTE.....	251
		SCHIEE COLTELLO PER GONIOATOMIA.....	373
		SCHIEINMANN INSERTO.....	472
		SCHERBAK SPECOLO VAGINALE.....	575
		SCHIACCIACOMEDONI, SAALFELD.....	608
		SCHIACCIACOMEDONI, SCHAMBERG.....	608
		SCHIACCIACOMEDONI, UNNA.....	608
		SCHIACCIACOMEDONI, WALTON.....	608
		SCHIACCIATORE PER L'INTESTINO E LO STOMACO, PAYR.....	548
		SCHIMMELBUSCH TAMBURO.....	622
		SCHINK DERMATOMO.....	49
		SCHIOETZ TONOMETRO.....	394/2
		SCHLESINGER PINZA TAGLIANTE PER LAMINECTOMIA.....	342
		SCHMEDEN PINZA NASALE.....	427
		SCHMID CANNULA PER IRRIGAZIONE.....	338
		SCHMIEDEN SPECILLO DI GUIDA SCANALATO.....	221
		SCHMIEDEN-DICK AGO PER LEGATURE.....	219
		SCHMIEDEN-TAYLOR FORBICI PER DURAMADRE.....	65/1
		SCHNIDT PINZA PER TONSILLE.....	467
		SCHOENBORN DIVARICATORE PER TIROIDE.....	479
		SCHROEDER CUCCHIAIO UTERINO.....	595
		SCHROEDER(POZZI) PINZA PER ABBASSARE IL COLLO DELL'UTERO.....	582
		SCHUBERT PINZA PER BIOPSIA.....	588
		SCHUKNECHT COLTELLO.....	418
		SCHULTZE SALPINGOGRAFO.....	596
		SCHULZE-BERGMANN SPECOLO RETTALE.....	560
		SCHUMACHER FORBICI PER STERNO.....	481
		SCHUMACHER INSERTO.....	472
		SCHUMACHER PINZA PER BIOPSIA.....	588, 589
		SCHWEIGGER PINZA CAPSULARE.....	391
		SCLEROTOMO, GUYTON-LUNDGAARD.....	373
		SCLEROTOMO, LUNDGAARD.....	373
		SCOVILLE CURETTA TAGLIANTE.....	253
		SCOVILLE DIVARICATORE PER LAMINECTOMIA.....	196
		SCOVILLE UNCINI PER RADICI DEI NERVI.....	330
		SCOVILLE VALVE.....	196
		SCOVILLE-HAVERFIELD DIVARICATORE PER LAMINECTOMIA.....	196
		SCUDDER PINZA INTESTINALE.....	541
		SEBILAU ELEVATORE.....	275
		SEDLITT PERIOSTOTOMO.....	274, 275
		SEGA, GIGLI.....	332
		SEGA ELETTRICA PER GESSI.....	230
		SEGA IN FILO D'ACCIAIO, OLIVECRONA.....	332
		SEGA NASALE, JOSEPH.....	446
		SEGA OSCILLANTE PER GESSI CON ASPIRAZIONE.....	231
		SEGA PER AMPUTAZIONE BIER.....	296
		SEGA PER AMPUTAZIONE, CHARRIERE.....	296
		SEGA PER AMPUTAZIONE, SATTERLEE.....	296
		SEGA PER AUTOPSIA.....	231/1
		SEGA PER DITA, LANGENBECK.....	296
		SEGA PER GESSI, ENGEL.....	229
		SEGA TAGLIA ANELLI, REDA.....	297
		SEGA TAGLIA ANELLI, WALTON.....	297
		SEGOND BISTURI PER FIBROMI.....	594
		SEGOND PINZA PER ISTERECTOMIA.....	125
		SEGOND-LANDAU PINZA PER ISTERECTOMIA.....	125
		SEIFERT INSERTO.....	472
		SELFIN PERIOSTOTOMO.....	277
		SELLHEIM CUCCHIAIO OSTETRICO.....	607
		SEMB CESOIA PER OSSA.....	242
		SEMB PERIOSTOTOMO.....	278
		SEMB PINZA PER BRONCHI.....	491
		SEMB PINZA SGORBIA.....	240
		SEMB TENAGLIA PER OSSA.....	243
		SEMKEN PINZA ANATOMICA.....	86

SEMKEN PINZA CHIRURGICA	86	SINGLEY PINZA PER AFFERRARE TESSUTI	88	SPECILLO DI GUIDA SCANALATO, SCHMIEDEN	221
SEMM SPECOLO VAGINALE	571	SINSKEY UNCINO	376	SPECILLO DI GUIDA, VIENNA	221
SENN-GREEN DIVARICATORE	153	SINUS ELEVATORE PER SETTO	438	SPECILLO FOGLIA MIRTE	199
SENN-MILLER DIVARICATORE	143	SIRINGA AURICOLARE	407	SPECILLO PER CANALE LACRIMALE BOWMAN	381
SEPERATORE PER IL CORPO MANDIBOLARE HARGIS	463/6	SIRINGA AURICOLARE, REINER	406	SPECILLO PER FISTOLE LOCKHART-MUMMERY	200
SEPERATORI SAGITTALI SMITH	463/5	SIRINGA PER TONSILLE	470	SPECILLO PER FISTOLE, PRATT	563
SEPTEMZANGE KNIGHT	425	SISTEMA DI FISSAGGIO, LEYLA	368, 368/1, 368/2, 368/3, 368/4	SPECILLO SCANALATO	199
SERPENTINE PINZA PER BIOPSIA	593	SISTEMA RETRATTORE	188	SPECILLO SCANALATO, BRODIE	199
SERRANODI KRAUSE	433/2	SKENE PINZA PER ABBASSARE IL COLLO		SPECILLO SCANALATO, DOYEN	199
SERRANODI KRAUSE-VOSS	433/2	DELL'UTERO	582	SPECILLO SCANALATO, NELATON	199
SERRANODI PER TONSILLE, BRUENINGS	468	SLS PINZA APPLICATORE CLIPS MICRO	524, 525	SPECILLO, FISH	199
SERRANODI PER TONSILLE, EVES	468	SLUDER-BALLENGER TONSILLOTOMO	470	SPECILLO, WATSON-CHEYNE	199
SERRANODI RETTALE, WESTON	566	SMELLIE PERFORATORE	607	SPECOLO AURICOLARE RICHNAU-HOLMGREN	400
SERRANODI WILDE	433/2	SMELLIE UNCINO	605	SPECOLO AURICOLARE, BOUCHERON	399
SET LARINGOSCOPIO FOREGGER	31	SMILLIE COLTELLO PER MENISCO	292	SPECOLO AURICOLARE, BRUENINGS	401
SET LARINGOSCOPIO MC INTOSH	31	SMILLIE ELEVATORE PER OSSA	291	SPECOLO AURICOLARE, GRUBER	399
SET PER INFERMERIA	609	SMITH BLEFAROSTATO	370	SPECOLO AURICOLARE, HARTMANN	399
SET PER SUTURA IN ASTUCCIO DI METALLO	225, 226	SMITH SEPARATORI SAGITTALI	463/5	SPECOLO AURICOLARE, POLITZER	399
SET PER TRACHEOTOMIA	478	SMITH US ARMY FORBICI PER BENDAGGI	69/1	SPECOLO AURICOLARE, SIEGLE	402
SET PER VARICI IN SCATOLA DI METALLO, NABATOFF	201	SMITH-BUIE DIVARICATORE ANALE	561	SPECOLO AURICOLARE, TOYNBEE	399
SEUTIN FORBICI PER BENDAGGI	69/2	SMITH-PETERSEN OSTEOTOMO	261	SPECOLO LATERALE	569
SEXTON COLTELLO AURICOLARE	408	SMITH-PETERSEN PINZA SGORBIA	238	SPECOLO NASALE HARTMANN	422
SFIGMOMANOMETRO, BABYPHON	10	SMITHWICK PINZA POSA CLIPS	326	SPECOLO NASALE REDA	423
SFIGMOMANOMETRO, DIPLOMAT	5	SMITHWICK UNCINO PER NERVI	329	SPECOLO NASALE, COTTLE	423
SFIGMOMANOMETRO, EXACTA	8	SNELLEN ANSA PER CATERATA	378	SPECOLO NASALE, HARTMANN-HALLE	421
SFIGMOMANOMETRO, MINIMUS II	11	SNELLEN PINZA PER ROVESCIARE PALPEBRE	393	SPECOLO NASALE, KILLIAN	423
SFIGMOMANOMETRO, MINIMUS III	12	SOMER PINZA PER AFFERRARE L'UTERO	585	SPECOLO NASALE, MOD.VIENNA	421
SFIGMOMANOMETRO, NOVA	6.7	SONDA BOTTUNUTA, JACOBSON	335	SPECOLO NASALE, THUDICHUM	421
SFIGMOMANOMETRO, PRECISA	9	SONDA CONDUITTRICE A FORCHETTA	475	SPECOLO NASALE, TIECK-HALLE	423
SGORBIA	264	SONDA CONDUITTRICE A FORCHETTA REDA	221	SPECOLO NASALE, VOLTOLINI	421
SGORBIA, PARTSCH	259	SONDA PER CALCOLI BILIARI DESJARDINS	532	SPECOLO RETTALE HILL-FERGUSON	560
SGORBIA ALEXANDER	259	SONDA PER CALCOLI BILIARI MOYNIHAN	532	SPECOLO RETTALE SAWYER	560
SGORBIA BRÜNINGS-LUCAS	260	SONDA PER CALCOLI BILIARI, MAYO	534	SPECOLO RETTALE, ALAN-PARKS	561
SGORBIA KILLIAN	442/1	SONDA PER GOZZO, KOCHER	479	SPECOLO RETTALE, BARR	559
SGORBIA PER CORPI ESTRANEI, DIX	374	SONDA, WORST	381	SPECOLO RETTALE, BODENHAMMER	559
SGORBIA PER CORPI ESTRANEI, ELLIS	374	SONDA, WORST	381	SPECOLO RETTALE, CZERNY	559
SGORBIA PER CORPI ESTRANEI, WALTON	374	SPATOLA ADDOMINALE	144	SPECOLO RETTALE, MATHIEU	560
SGORBIA PER SETTO FREER	442/1	SPATOLA ADDOMINALE E INTESTINALE LERICHE	143/2	SPECOLO RETTALE, PRATT	559
SGORBIA PER SETTO, HAJEK	442/1	SPATOLA ADDOMINALE E INTESTINALE, HABERER	143/1	SPECOLO RETTALE, SIMS	559
SGORBIA PER SETTO, KILLIAN-CLAUS	442/1	SPATOLA ADDOMINALE E INTESTINALE, REVERDIN	143/1	SPECOLO RETTALE, SCHULZE-BERG	560
SGORBIA WEST	442/1	SPATOLA ADDOMINALE E INTESTINALE, RIBBON	143	SPECOLO VAGINALE, JACKSON	573
SGORBIA, COBB	262	SPATOLA ADDOMINALE ED INTESTINALE KADER	143/1	SPECOLO VAGINALE, AUWARD	576
SGORBIA, HIBBS	265	SPATOLA ADDOMINALE ED INTESTINALE KÖRTE	143/1	SPECOLO VAGINALE, BREISKY	577
SGORBIA, LEXER MINI	263	SPATOLA ADDOMINALE ED INTESTINALE KÜMMEL	143/2	SPECOLO VAGINALE, COLLIN	570
SGORBIA, ZIELKE	264	SPATOLA CEREBRALE CUSHING	369	SPECOLO VAGINALE, CUSCO	570, 571
SGORBIA, STILLE	260	SPATOLA CEREBRALE DAVIS	337	SPECOLO VAGINALE, DOYEN	574
SGORBI	259	SPATOLA CEREBRALE HEIFETZ	369	SPECOLO VAGINALE, FRIEDMANN	577
SHAMBAUGH UNCINO	419	SPATOLA CEREBRALE, CUSHING	336	SPECOLO VAGINALE, GRAVE	570
SHAPLEIGH ANSA AURICOLARE	410	SPATOLA CEREBRALE, OLIVECRONA	336	SPECOLO VAGINALE, KALLMORGEN	573
SHEA MICRO FORBICI AURICOLARI	413	SPATOLA PER CICLODIALISI HIRSCHMAN	379	SPECOLO VAGINALE, KRISTELLER	572
SHEEHAN OSTEOTOMO PER SETTO	441	SPATOLA PER CICLODIALISI, BANGERTER	379	SPECOLO VAGINALE, LANDAU	577
SHEETS CANNULA PER IRRIGAZIONE	394/2	SPATOLA PER CICLODIALISI, ELSCHNIG	379	SPECOLO VAGINALE, O'SULLIVAN-O'CONNOR	576
SIEBENMANN CANNULA PER IRRIGAZIONE	433	SPATOLA PER CICLODIALISI, WHEELER	379	SPECOLO VAGINALE, PEDERSON	570
SIEBOLD FORBICI GINECOLOGICHE	62	SPATOLA PER CICLODIALISI, CASTROVIEJO	379	SPECOLO VAGINALE, SEMM	571
SIEGLE SPECOLO AURICOLARE	402	SPATOLA PER IRIDE, CULLER	378	SPECOLO VAGINALE, SIMS	573
SILVER DERMATOMO	50	SPATOLA PER IRIDE, CULLER	378	SPECOLO VAGINALE, TRELAT	571
SILVER SCALPELLO PER SETTO	442	SPATOLA PER IRIDE, WECKER	378	SPECOLO VAGINALE, VU-MORE	569
SIMCOE CANNULA PER IRRIGAZIONE	394	SPATOLA PER PEDICURE	612	SPECOLO VAGINALE, SCHERBAK	575
SIMON CUCCHIAIO UTERINO	594	SPATOLA PER POLMONE, ALLISON	489	SPENCER FORBICI PER LEGATURE	66
SIMON DIVARICATORE	164	SPATOLA ROBB	530	SPENCER-WELLS PINZA EMOSTATICA	109
SIMPLEX PINZA SERRATUBI	624	SPATOLA VESCICALE, KOCHER	552	SPIZZATORE UNGHIE	612/1
SIMPSON FORCIPE	602	SPATOLA VESCICALE, LEGUEU	552	SPILLONE PER STERILIZZAZIONE, BUNT	227
SIMPSON-BRAUN FORCIPE	602	SPAZZOLA PER UNGHIE	611	SPILLONE PER STERILIZZAZIONE, MAYO	227
SIMPSON-LUIKART FORCIPE	603	SPECCHIO FRONTALE ZIEGLER	21	SPINAL CURETTA TAGLIANTE	253
SIMS CURETTE UTERINI	597, 598	SPECCHIO LARINGEO	473	SPINA-NASALIS DIVARICATORE	461
SIMS DEPRESSORE UTERINO	586	SPECCHIO LARINGEO, MICHEL	423	SPRATT CURETTA TAGLIANTE	251
SIMS DILATATORE UTERINO	581	SPECILLO AURICALE, STACKE	199	SPRATT CURETTA TAGLIANTE PER LAMINECTOMIA	340
SIMS FORBICI GINECOLOGICHE	62	SPECILLO DI GUIDA SCANALATO KÖNIG	221	SPUTACCHIERA	621
SIMS ISTEROMETRO	586	SPECILLO DI GUIDA SCANALATO BRUNNER	221	ST. CLAIR-THOMSON COLTELLO ADENOIDE	450
SIMS SPECOLO RETTALE	559	SPECILLO DI GUIDA SCANALATO KIRSCHNER	221	ST. MARKS DIVARICATORE PELVICO	165
SIMS SPECOLO VAGINALE	573	SPECILLO DI GUIDA SCANALATO SCHMIEDEN-PAYR	221	ST. MARTIN PINZA PER SUTURA	392
SIMS-MAIER PINZA PER MEDICATURA	134	SPECILLO DI GUIDA SCANALATO, BRUNNER	221	STACKE SPECILLO AURICALE	199
		SPECILLO DI GUIDA SCANALATO, PAYR	221	STANDARD FORBICI PER CHIRURGIA	51

STAUDE-MOORE PINZA PER ABBASSARE IL COLLO		T		TOWNSEND MANICO SOLO.....	591
DELL'UTERO.....	582	TABB COLTELLO.....	418	TOYNBEE SPECOLO AURICOLARE.....	399
STEINMANN CHIODI.....	307, 308	TAKAHASHI PINZA NASALE.....	427	TRASFORMATORE RICARICA BATTERIA.....	34
STEINMANN PINZA PER AFFERRARE TENDINI.....	292	TAMBURO, SCHIMMELBUSCH.....	622	TRATTORE, BARTON.....	603
STELLBRINK PINZA SGORBIA.....	234	TAMPONATORE „LUNIATSCHKE“.....	465	TRATTORE, BILL.....	604
STERNBERG DIVARICATORE PER GUANCE.....	453	TARNIER CRANIOCLASTO.....	607	TRATTORE, LUIKART-BILL.....	604
SCALPELLO PER STERNO, LEBSCHÉ.....	267	TARNIER FORCIPE.....	604	TRAVERS DIVARICATORE.....	172
STETOSCOPIO, ANESTOPHON.....	23	TAYLOR - USA MARTELLO DA PERCUSSIONE.....	24	TREFINA CUTANEA, KEYES.....	608
STETOSCOPIO, DUPLEX.....	23	TAYLOR DIVARICATORE SPINALE.....	291	TRELAT SPECOLO VAGINALE.....	571
STETOSCOPIO, PINARD.....	23	TAYLOR PINZA CHIRURGICA.....	87	TREQUARTO PER SENO MASCELLARE, COAKLEY.....	204
STETOSCOPIO.....	23	TC FORBICI PER CHIRURGIA FINE, REYNOLDS TC.....	54	TREQUARTO PER SENO MASCELLARE, LICHTWITZ.....	204
STEVENS FORBICI PER OFTALMOLOGIA.....	58	TC FORBICI PER CHIRURGIA STANDARD.....	51	TREQUARTO PER SENO MASCELLARE, PIERCE.....	204
STEVENS PINZA PER IRIDE.....	383	TC PINZA ANATOMICA.....	81	TREQUARTO PER SINOSCOPIA.....	205
STEVENS PORT'AGHI.....	214	TC PINZA CHIRURGICA.....	81	TREQUARTO PER SINOSCOPIA.....	205
STEVENS SUPERCUT FORBICI.....	72	TC PINZA CUSHING.....	83	TREQUARTO, NELSON.....	205
STEVENS UNCINO PER TENOTOMIA.....	375	TC PINZA CUSHING TAYLOR.....	87	TREQUARTO, OCHSNER.....	205
STEVENSON BLEFAROSTATO.....	371	TC PINZA GILLIES.....	86	TREQUARTO, UNIVERSAL.....	204
STIEGLITZ PINZA PER SCHEGGE.....	92	TC PINZA SEMKEN.....	86	TREQUARTO, STANDARD (NELSON).....	204
STILLE CESOIA PER GESSI.....	229	TC PINZA WANGENSTEEN.....	89	TROELTSCH PINZA AURICOLARE.....	424
STILLE COSTOTOMO.....	480	TEALE PINZA PER ABBASSARE IL COLLO DELL'UTERO.....	583	TROEMNER PERKUSSIONSMARTELLO.....	24
STILLE OSTEOTOMO.....	260	TEBBETS DIVARICATORE PER CHIRURGIA PLASTICA.....	197	TRONCHESINA PER PELLE.....	610
STILLE PERFORATORE A MANO.....	298	TELAIO PIEGABILE KIRSCHNER.....	187	TRONCHESINA PER UNGHIE.....	612/1, 613
STILLE PINZA ANATOMICA.....	81	TENAGLIA PER OSSA.....	247	TRONCHESINA PER UNGHIE ANVIL.....	613
STILLE PINZA CHIRURGICA.....	81/1	TENAGLIA PER OSSA, LANE.....	249	TRONCHESINA PER UNGHIE, TURNBULL.....	609
STILLE PINZA EMOSTATICA.....	122	TENAGLIA PER OSSA, BIRCHER-GANSKE.....	246	TROUSSEAU DILATATORE TRACHEALE.....	476
STILLE SCALPELLO.....	260	TENAGLIA PER OSSA, ADSON.....	298	TROUSSEAU-BABY DILATATORE TRACHEALE.....	476
STILLE SGORBIA.....	260	TENAGLIA PER OSSA, DINGMANN.....	246	TROUTMAN PINZA PER IRIDE.....	389
STILLE-BARRAYA PINZA VASCOLARE.....	88	TENAGLIA PER OSSA, FARABEUF.....	243	TROUTMAN-CHRIS ROMPLAMETTE.....	45
STILLE-HORSLEY CESOIA PER OSSA.....	242	TENAGLIA PER OSSA, FARABEUF-L.....	243	TUBBS DILATATORE.....	528
STILLE-LISTON CESOIA PER OSSA.....	242	TENAGLIA PER OSSA, FERGUSSON.....	243	TÜBINGEN PINZA PER FILO.....	392
STILLE-LUER PINZA SGORBIA.....	239	TENAGLIA PER OSSA, KERN.....	244	TUBO DI PROLUNGAMENTO, BRUENINGS.....	472
STILLE-RUSKIN PINZA SGORBIA.....	239	TENAGLIA PER OSSA, LAMBOTTE.....	244	TUFFIER DIVARICATORE.....	147
STILLE-SHERMAN PERFORATORE A MANO.....	298	TENAGLIA PER OSSA, LANE.....	244	TUFFIER DIVARICATORE COSTALE.....	487
STOCKMANN PINZA SERRAPENE.....	553/1	TENAGLIA PER OSSA, LANGENBECK.....	243	TUFFIER PINZA PER AFFERRARE TESSUTI.....	110
STONE-WATT COMPRESSORE.....	545	TENAGLIA PER OSSA, LEWIN.....	246	TURNBULL TRONCHESINA PER UNGHIE.....	609
STRANDELL-STILLE DIVARICATORE.....	157	TENAGLIA PER OSSA, MARTIN.....	246	TURREL PINZA INTESTINALE PER BIOPSIA.....	567
STRATTE PORT'AGHI.....	212	TENAGLIA PER OSSA, REILL.....	248	TYDING PINZA PER TONSILLE.....	467, 468
STRAUSS PINZA SERRAPENE.....	553/1	TENAGLIA PER OSSA, SEMB.....	243	TYDING TONSILLOTOMO.....	469
STRUJEMPEL PINZA PER CORPI ESTRANEI.....	412	TENAGLIA PER OSSA, ULRICH.....	248		
STRULLY FORBICI PER NEUROCHIRURGIA.....	65	TENAGLIA PER OSSA, VAN BUREN.....	249	U	
STRUMENTI PER CORPI ESTRANEI, DIX.....	380	TENAGLIA PER OSSA, VERBRUGGE.....	245	UCKERMANN PORTACOTONE.....	203
STRUMENTO PER CIRCONCISIONE.....	556	TENAGLIA PER OSSA, TAGLIAFILI.....	317, 318	ULRICH PINZA PER MEDICATURA.....	135
STRUMENTO PER MISURE.....	594	TERSON PINZA CAPSULARE.....	391	ULRICH TENAGLIA PER OSSA.....	248
STRUMENTO PER VARICI VARADY.....	202	TESSIER DIVARICATORE.....	463/3	ULTRA-LIGHT-PINZA, ATRAUMATICA.....	95
STRUMENTO TENDIFILI, DEMEL.....	315	THOMAS CURETTE UTERINI.....	599	UNCINO ACUTO LAHEY.....	149
STRUMENTO TENDIFILI, LOUTE.....	315	THOMAS-GAYLOR PINZA PER BIOPSIA.....	588	UNCINO DI FISSAZIONE, BURCH.....	373
STRUYCKEN PINZA NASALE.....	427	THOMAS-ALLIS PINZA PER AFFERRARE INTESTINI.....	538	UNCINO DIVARICATORE, KNAPP.....	375
STUOIA IN SILICONE.....	616	THOMSON-WALKER DIVARICATORE VESCICALE.....	552	UNCINO DIVARICATORE, ROLLET.....	375
SUBRAMANIAN-MINIATURE PINZA PER AORTA PEDIATRICA.....	521	THOREK, FORBICI TORACALI.....	65/2	UNCINO ESTRATTORE.....	322
SUPERCUT FORBICI.....	71	THUDICHUM SPECOLO NASALE.....	421	UNCINO ESTRATTORE, ARRUGA.....	375
SUPERCUT FORBICI IRIS.....	72	TIECK-HALLE SPECOLO NASALE.....	423	UNCINO GALEA, YASARGIL.....	330
SUPERCUT FORBICI KILNER.....	72	TILLEY PINZA AURICOLARE.....	411	UNCINO GASS.....	376
SUPERCUT FORBICI LISTER.....	72	TIRAMIOMI, DOYEN.....	594	UNCINO KUGLEN.....	376
SUPERCUT FORBICI REYNOLDS.....	72	TIRAVENE.....	202	UNCINO NASALE AUFRICHT.....	447
SUPERCUT FORBICI STEVENS.....	72	TISCHLER PINZA PER BIOPSIA.....	591	UNCINO NASALE CONVERSE.....	448
SUPERCUT FORBICI WAGNER.....	72	TISCHLER-KEVORKIAN PINZA PER BIOPSIA.....	592	UNCINO NASALE UNCINO.....	447
SUPERCUTFORBICI MAYO.....	71	TISCHLER-MORGAN PINZA PER BIOPSIA.....	590, 591	UNCINO NASALE, COTTLE.....	447
SUPERCUTFORBICI MAYO-STILLE.....	71	TITAN PINZA EMOSTATICA, CRILLE.....	107	UNCINO NASALE, MASING-NEIVERT.....	447
SUPERCUTFORBICI METZENBAUM.....	71	TITAN PINZA EMOSTATICA, KELLY.....	106	UNCINO PER DURA MADRE, JACOBSON.....	335
SUPERCUTFORBICI, BABY METZENBAUM.....	71	TOBOLD ABBASSALINGUA.....	453	UNCINO PER DURAMADRE.....	335
SUPPORTO PER PETTO NEGUS.....	459	TOBOLD PORTACOTONE.....	203	UNCINO PER DURAMADRE, ADSON.....	329
SUPPORTO PER STERILIZZAZIONE FILI KIRSCHNER.....	305	TOENNIS PINZA EMOSTATICA.....	117	UNCINO PER FISTOLE, EMMETT.....	594
SUPPORTO PER TUBO.....	188	TOENNIS DURA DISSETTORE.....	332	UNCINO PER IL STRABISMO, GRAEFE.....	375
SUPPORTO UNIVERSALE PER DIVARICATORI.....	188	TOENNIS-ADSON FORBICI PER NEUROCHIRURGIA.....	65	UNCINO PER IL STRABISMO, GREEN.....	375
SUPPORTO UNIVERSALE PER ENDOSCOPIO.....	188	TOGLILAMA.....	42	UNCINO PER IL STRABISMO, JAMESON.....	375
SUPPORTO, ROCHARD.....	186	TOHUKU PINZA FISSATELI.....	132	UNCINO PER IRIDE, O'CONNOR.....	375
SWEET PINZA POSA CLIPS.....	326	TONOMETRO, SCHIOETZ.....	394/2	UNCINO PER IRIDE, WIENER.....	375
SYSTRUNK FORBICI PER CHIRURGIA.....	66	TONSILLOTOMO, SLUDER-BALLENGER.....	470	UNCINO PER LA PELLE, GRAEFE.....	149
		TONSILLOTOMO, TYDING.....	469	UNCINO PER LA PELLE, COTTLE-NEIVERT.....	448
		TOOK DISSETTORE CORNEALE.....	373	UNCINO PER LA PELLE, FOMON.....	447/1
		TOURNIQUET RUMEL-BELMONT.....	528	UNCINO PER LA PELLE, FRAZIER.....	149
		TOWNSEND PINZA PER BIOPSIA.....	591	UNCINO PER LA PELLE, FREER.....	448
				UNCINO PER LA PELLE, GILLIES.....	448

UNCINO PER LA PELLE, GUTHRIE.....	149
UNCINO PER LA PELLE, JOSEPH.....	149
UNCINO PER LA PELLE, KILNER.....	608
UNCINO PER LA PELLE, KLEINERT-KUTZ.....	149
UNCINO PER LA PELLE, REDA.....	150
UNCINO PER LE PINNE NASALI LANGE.....	448
UNCINO PER MUSCOLI.....	267
UNCINO PER NERVI D'ERRICO.....	329/2
UNCINO PER NERVI, CRILE.....	328
UNCINO PER NERVI, CUSHING.....	328
UNCINO PER NERVI, DANDY.....	328
UNCINO PER NERVI, GRAHAM.....	329
UNCINO PER NERVI, HESS.....	329/1
UNCINO PER NERVI, KRAYENBUEHL.....	336
UNCINO PER NERVI, LOVE.....	329/2
UNCINO PER NERVI, SACHS.....	329
UNCINO PER NERVI, SMITHWICK.....	329
UNCINO PER RADICI DEI NERVI, HOLLSHER.....	329/1
UNCINO PER RADICI DEI NERVI, LOVE.....	330
UNCINO PER RADICI DEI NERVI, SCOVILLE.....	330
UNCINO PER TENOTOMIA, STEVENS.....	375
UNCINO SHAMBAUGH.....	419
UNCINO SINSKEY.....	376
UNCINO SPEZZATORE, BRAUN.....	607
UNCINO, BARBARA.....	419
UNCINO, DAY.....	409
UNCINO, FISCH.....	335
UNCINO, LUCAE.....	409
UNCINO, MCGEE.....	419
UNCINO, SMELLIE.....	605
UNCINO, WAGENER.....	409
UNI I COMBINAZIONE PER DIAGNOSTICA CON ILLUMINAZIONE STANDARD.....	13
UNI II COMBINAZIONE PER DIAGNOSTICA CON ILLUMINAZIONE STANDARD.....	14
UNI III COMBINAZIONE PER DIAGNOSTICA CON ILLUMINAZIONE STANDARD.....	15
UNIVERSAL FORBICI PER BENDAGGI.....	70
UNIVERSAL FORBICI PER FILO DI METALLO E LAMIERA.....	67
UNIVERSAL PINZA PER STERILIZZAZIONE.....	227
UNIVERSAL TREQUARTO.....	204
UNNA SCHIACCIACCOMEDONI.....	608
URETROTOMO OTIS.....	553
US ARMY DIVARICATORE.....	141
USA PINZA ANATOMICA.....	81

V

VACUMENTRO PER VUOTI DI SANGUE.....	295
VALLEIX ISTEROMETRO.....	586
VALVE CON ADATTATORI AL TELAIO.....	194
VALVE, SCOVILLE.....	196
VAN BUREN CANDELETTA DILATATRICE.....	554
VAN BUREN TENAGLIA PER OSSA.....	249
VAN DOREN PINZA PER BIOPSIA.....	588
VANNAS FORBICI OCULISTICHE.....	79
VARADY STRUMENTO PER VARICI.....	202
VASSOIO PER PASTIGLIE.....	621
VERBRUGGE TENAGLIA PER OSSA.....	245
VERBRUGGE-MÜLLER ELEVATORE PER OSSA.....	286/2
VERESS AGO DI GUIDA.....	206
VIENNA SPECILLO DI GUIDA SCANALATO.....	221
VIRCHOW, COLTELLO PER CARTILAGINE E DISSEZIONE.....	48
VIRTUS(RALK) PINZA PER SCHEGGE.....	92
VOLKMANN CURETTA TAGLIENTE.....	251
VOLKMANN CURETTA TAGLIENTE.....	257
VOLKMANN DIVARICATORE.....	153
VOLKMANN DIVARICATORE.....	154
VOLKMANN DIVARICATORE.....	156
VOLTOLINI SPECILO NASALE.....	421
VU-MORE SPECILO VAGINALE.....	569

W

WACHENFELDT PINZA PER AGRAFES.....	224
WADSWORTH-TODD CAUTERIO.....	378
WAGENER-MOSHER CANNULA TRACHEALE.....	477
WAGENR UNCINO.....	409
WAGNER FORBICI GINGIVALI.....	67
WAGNER PINZA TAGLIENTE PER LAMINECTOMIA.....	343
WAGNER SUPERCUT FORBICI.....	72
WALLICH CUCCHIAIO PER ABORTO.....	607
WALSHAM PINZA PER RADDRIZZARE IL SETTO NASALE.....	449
WALTON SGORBIA PER CORPI ESTRANEI.....	374
WALTON SCHIACCIACCOMEDONI.....	608
WALTON SEGA TAGLIA ANELLI.....	297
WANGENSTEEN PINZA VASCOLARE.....	89
WANGENSTEEN PORT'AGHI.....	210
WARTENBERG ALGESIMETRO.....	25
WATSON DERMATOMO.....	50
WATSON-CHEYNE ELEVATORE.....	283
WATSON-CHEYNE SPECILLO.....	199
WATSON-WILLIAMS PINZA NASALE.....	428
WAUGH PINZA CHIRURGICA.....	83
WEBER ANSA PER CATERATTA.....	378
WEBER PINZA PER AORTA.....	501
WEBSTER PORT'AGHI.....	208
WECKER FORBICI OCULISTICHE.....	75
WECKER SPATOLA PER IRIDE.....	378
WEEK BLEFAROSTATO.....	370
WEIL-BLAKESLEY PINZA NASALE.....	426
WEITLANER DIVARICATORE.....	169
WEITLANER-WULLSTEIN DIVARICATORE.....	169
WELLER, FORBICI PER DISSEZIONE.....	53/2
WELLS CUCCHIAIO PER ENUCLEAZIONE.....	378
WERTHEIM FORBICI PER ISTERECTOMIA.....	63
WERTHEIM PINZA PER ISTERECTOMIA.....	124
WERTHEIM PINZA PER ISTERECTOMIA.....	128
WERTHEIM-CULLEN PINZA PER PEDUNCOLO RENALE.....	125
WESTCOTT FORBICI OCULISTICHE.....	75
WESTMACOTT PINZA NASALE PER TAMPONI.....	424
WESTON SERRANODI RETTALE.....	566
WHEELER COLTELLO LANCEOLARE.....	373
WHEELER SPATOLA PER CICLODIALISI.....	379
WHITE PINZA PER TONSILLE.....	467
WIEDER ABBASSALINGUA.....	452
WIENER RASPA NASALE.....	443
WIENER UNCINO PER IRIDE.....	375
WIGMORE COLTELLO PER GESSI.....	229
WIKSTROEM PINZA EMOSTATICA.....	117
WILDE SERRANODI.....	411
WILDE SERRANODI.....	433/2
WILDE(TROELTSCH) PINZA AURICOLARE.....	410
WILDER ANSA PER CATERATTA.....	378
WILLET MARTEL PINZA DA PRESA.....	110
WILLIAMS BLEFAROSTATO.....	370
WILLIAMS CACCIAVITE.....	323
WILLIAMS PINZA PER AFFERRARE INTESTINI.....	539
WILLIGER CURETTA TAGLIENTE.....	255
WILLIGER MARTELLO.....	271
WILLIGER PERIOTOTOMO.....	276
WINTER PINZA PER ABORTO.....	606
WITTNER PINZA PER BIOPSIA.....	589
WOLFF PINZA STRAPPAGESSI.....	233
WOODSON DURA DISSETTORE.....	333
WORST, SONDA.....	381
WRIGLEY FORCIPE.....	602
WULLSTEIN COLTELLO.....	418
WULLSTEIN DIVARICATORE.....	171
WULLSTEIN MANICO D'ASPIRAZIONE.....	338
WULLSTEIN MICRO PINZA AURICOLARE A CUCCHIAIO.....	416
WYLLIE DILATATORE UTERINO.....	581

Y

YANCOSKIE DIVARICATORE PER CHIRURGIA PLASTICA.....	198
YANKAUER DISSETTORE PER TONSILLE.....	465
YASARGIL CANNULA D'ASPIRAZIONE.....	337/2
YASARGIL CLIPS PER ANEURISMA.....	345 - 356
YASARGIL PINZA PER TUMORI.....	97
YASARGIL UNCINO GALEA.....	330
YEOMAN PINZA INTESTINALE PER BIOPSIA.....	566, 567
YOUNG BOOMERANG PER SUTURE.....	220
YOUNG DIVARICATORE PER LA PROSTATA.....	550
YOUNG PINZA TIRALINGUA.....	453

Z

ZAUFAL ELEVATORE AURICOLARE.....	409
ZAUFAL-JANSEN ELEVATORE AURICOLARE.....	409
ZAUFAL-JANSEN PINZA SGORBIA.....	238
ZENKER DIVARICATORE.....	161
ZENKER PINZA EMOSTATICA.....	118
ZIEGLER BLEFAROSTATO.....	371
ZIEGLER COLTELLO LANCEOLARE.....	373
ZIEGLER COLTELLO PER IRIDE.....	372
ZIEGLER DILATATORE PER CANALE LACRIMALE.....	381
ZIEGLER SPECCHIO FRONTALE.....	21
ZIELKE SGORBIA.....	264
ZÖLLNER CANNULA D'ASPIRAZIONE.....	337/2

Weitere Kataloge und Prospekte
Other cataloges and prospects

Endoskopie
Endoscopy

Titan Instrumente
Titanium Instruments

Container Steriltechnik
Container Sterilization Technique

HERCULES Drahtkneifzange
HERCULES Wire Cutters

Neurochirurgie
Neuro Surgery

Plastische Chirurgie
Plastic Surgery

Orthopädie
Orthopedic



Gänsäcker 34
P.O. Box 131
D-78532 Tuttlingen
Germany



Fon +49 74 62.94 45-0
Fax +49 74 62.94 45-20
info@Reda-Instrumente.de
www.Reda-Instrumente.de

